



Full wwPDB EM Validation Report ⓘ

May 13, 2023 – 02:22 pm BST

PDB ID : 7ZNK
EMDB ID : EMD-14804
Title : Structure of an endogenous human TREX complex bound to mRNA
Authors : Pacheco-Fiallos, F.B.; Vorlaender, M.K.; Plaschka, C.
Deposited on : 2022-04-21
Resolution : 3.90 Å (reported)

This is a Full wwPDB EM Validation Report for a publicly released PDB entry.

We welcome your comments at validation@mail.wwpdb.org

A user guide is available at

<https://www.wwpdb.org/validation/2017/EMValidationReportHelp>

with specific help available everywhere you see the ⓘ symbol.

The types of validation reports are described at

<http://www.wwpdb.org/validation/2017/FAQs#types>.

The following versions of software and data (see [references ⓘ](#)) were used in the production of this report:

EMDB validation analysis : 0.0.1.dev50
MolProbity : 4.02b-467
Percentile statistics : 20191225.v01 (using entries in the PDB archive December 25th 2019)
MapQ : 1.9.9
Ideal geometry (proteins) : Engh & Huber (2001)
Ideal geometry (DNA, RNA) : Parkinson et al. (1996)
Validation Pipeline (wwPDB-VP) : 2.32.2

1 Overall quality at a glance i

The following experimental techniques were used to determine the structure:
ELECTRON MICROSCOPY

The reported resolution of this entry is 3.90 Å.

Percentile scores (ranging between 0-100) for global validation metrics of the entry are shown in the following graphic. The table shows the number of entries on which the scores are based.

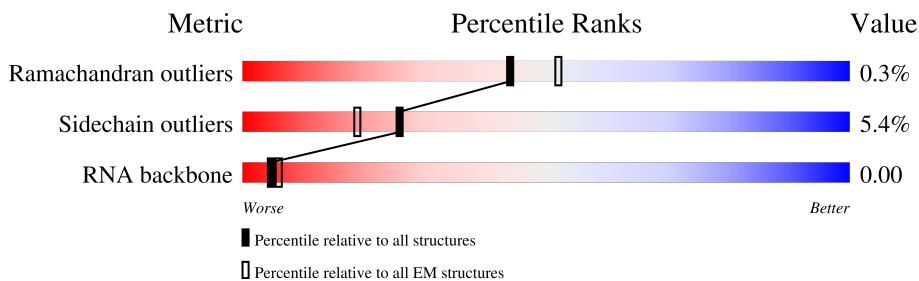

Metric	Whole archive (#Entries)	EM structures (#Entries)
Ramachandran outliers	154571	4023
Sidechain outliers	154315	3826
RNA backbone	4643	859

The table below summarises the geometric issues observed across the polymeric chains and their fit to the map. The red, orange, yellow and green segments of the bar indicate the fraction of residues that contain outliers for ≥ 3 , 2, 1 and 0 types of geometric quality criteria respectively. A grey segment represents the fraction of residues that are not modelled. The numeric value for each fraction is indicated below the corresponding segment, with a dot representing fractions $\leq 5\%$. The upper red bar (where present) indicates the fraction of residues that have poor fit to the EM map (all-atom inclusion $< 40\%$). The numeric value is given above the bar.

Mol	Chain	Length	Quality of chain
1	2	3	100% 33% 67%
1	4	3	100% 33% 67%
2	A	657	8% 50% 46%
2	I	657	11% 54% 45%
2	a	657	15% 50% 46%
2	i	657	16% 54% 45%
3	B	1593	8% 53% 42%
3	J	1593	13% 53% 43%

Continued on next page...

Continued from previous page...

Mol	Chain	Length	Quality of chain
3	b	1593	9% 53% 5% 42%
3	j	1593	18% 53% • 43%
4	C	351	6% 77% 11% 12%
4	K	351	15% 77% 11% 12%
4	c	351	7% 77% 11% 12%
4	k	351	13% 77% 11% 12%
5	E	683	23% 78% 21%
5	M	683	20% 80% 20%
5	e	683	28% 77% 23%
5	m	683	25% 80% 20%
6	F	341	16% 98% ••
6	N	341	70% 98% ••
6	f	341	13% 96% ••
6	n	341	72% 98% ••
7	G	204	37% 79% 21%
7	O	204	17% 80% 20%
7	g	204	40% 79% 21%
7	o	204	23% 80% 20%
8	H	428	9% 40% 60%
8	P	428	67% 85% • 14%
8	h	428	9% 40% 60%
8	p	428	68% 85% • 14%
9	L	257	6% 6% 94%
9	l	257	6% 6% 94%

2 Entry composition [i](#)

There are 9 unique types of molecules in this entry. The entry contains 88261 atoms, of which 0 are hydrogens and 0 are deuteriums.

In the tables below, the AltConf column contains the number of residues with at least one atom in alternate conformation and the Trace column contains the number of residues modelled with at most 2 atoms.

- Molecule 1 is a RNA chain called RNA.

Mol	Chain	Residues	Atoms					AltConf	Trace
			Total	C	N	O	P		
1	2	3	60	27	6	24	3	0	0
1	4	3	60	27	6	24	3	0	0

- Molecule 2 is a protein called THO complex subunit 1.

Mol	Chain	Residues	Atoms					AltConf	Trace
			Total	C	N	O	S		
2	A	356	2889	1864	481	531	13	0	0
2	I	363	2935	1894	489	539	13	0	0
2	a	356	2889	1864	481	531	13	0	0
2	i	363	2936	1894	489	540	13	0	0

- Molecule 3 is a protein called THO complex subunit 2.

Mol	Chain	Residues	Atoms					AltConf	Trace
			Total	C	N	O	S		
3	B	919	7012	4486	1206	1278	42	0	0
3	J	914	6956	4452	1194	1268	42	0	0
3	b	919	7012	4486	1206	1278	42	0	0
3	j	914	6956	4452	1194	1268	42	0	0

- Molecule 4 is a protein called THO complex subunit 3.

Mol	Chain	Residues	Atoms					AltConf	Trace
			Total	C	N	O	S		
4	C	309	Total 2433	C 1538	N 423	O 457	S 15	0	0
4	K	309	Total 2433	C 1538	N 423	O 457	S 15	0	0
4	c	309	Total 2433	C 1538	N 423	O 457	S 15	0	0
4	k	309	Total 2433	C 1538	N 423	O 457	S 15	0	0

- Molecule 5 is a protein called THO complex subunit 5 homolog.

Mol	Chain	Residues	Atoms					AltConf	Trace
			Total	C	N	O	S		
5	E	538	Total 3765	C 2385	N 663	O 696	S 21	0	0
5	M	549	Total 4136	C 2636	N 725	O 752	S 23	0	0
5	e	527	Total 3676	C 2329	N 649	O 679	S 19	0	0
5	m	549	Total 4136	C 2636	N 725	O 752	S 23	0	0

There are 8 discrepancies between the modelled and reference sequences:

Chain	Residue	Modelled	Actual	Comment	Reference
E	525	ILE	VAL	conflict	UNP Q13769
E	579	ILE	VAL	conflict	UNP Q13769
M	525	ILE	VAL	conflict	UNP Q13769
M	579	ILE	VAL	conflict	UNP Q13769
e	525	ILE	VAL	conflict	UNP Q13769
e	579	ILE	VAL	conflict	UNP Q13769
m	525	ILE	VAL	conflict	UNP Q13769
m	579	ILE	VAL	conflict	UNP Q13769

- Molecule 6 is a protein called THO complex subunit 6 homolog.

Mol	Chain	Residues	Atoms					AltConf	Trace
			Total	C	N	O	S		
6	F	337	Total 2604	C 1647	N 459	O 483	S 15	0	0
6	N	337	Total 2604	C 1647	N 459	O 483	S 15	0	0
6	f	329	Total 2537	C 1604	N 448	O 470	S 15	0	0

Continued on next page...

Continued from previous page...

Mol	Chain	Residues	Atoms					AltConf	Trace
6	n	337	Total	C	N	O	S	0	0
			2604	1647	459	483	15		

- Molecule 7 is a protein called THO complex subunit 7 homolog.

Mol	Chain	Residues	Atoms					AltConf	Trace
7	G	161	Total	C	N	O		0	0
			800	478	161	161			
7	O	164	Total	C	N	O	S	0	0
			1129	696	210	216	7		
7	g	161	Total	C	N	O		0	0
			800	478	161	161			
7	o	164	Total	C	N	O	S	0	0
			1129	696	210	216	7		

- Molecule 8 is a protein called Spliceosome RNA helicase DDX39B.

Mol	Chain	Residues	Atoms					AltConf	Trace
8	H	170	Total	C	N	O	S	0	0
			1398	888	245	261	4		
8	P	367	Total	C	N	O	S	0	0
			2974	1897	517	538	22		
8	h	170	Total	C	N	O	S	0	0
			1398	888	245	261	4		
8	p	367	Total	C	N	O	S	0	0
			2974	1897	517	538	22		

- Molecule 9 is a protein called THO complex subunit 4.

Mol	Chain	Residues	Atoms				AltConf	Trace
9	L	16	Total	C	N	O	0	0
			80	48	16	16		
9	l	16	Total	C	N	O	0	0
			80	48	16	16		

3 Residue-property plots [i](#)

These plots are drawn for all protein, RNA, DNA and oligosaccharide chains in the entry. The first graphic for a chain summarises the proportions of the various outlier classes displayed in the second graphic. The second graphic shows the sequence view annotated by issues in geometry and atom inclusion in map density. Residues are color-coded according to the number of geometric quality criteria for which they contain at least one outlier: green = 0, yellow = 1, orange = 2 and red = 3 or more. A red diamond above a residue indicates a poor fit to the EM map for this residue (all-atom inclusion < 40%). Stretches of 2 or more consecutive residues without any outlier are shown as a green connector. Residues present in the sample, but not in the model, are shown in grey.

- Molecule 1: RNA

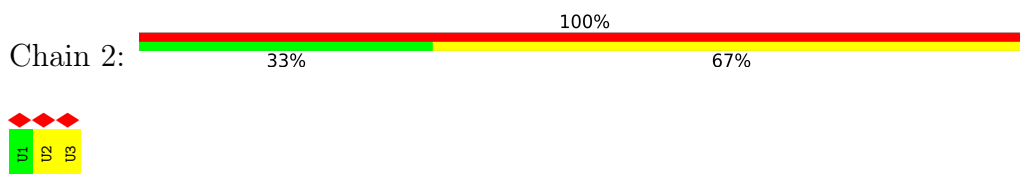

- Molecule 1: RNA

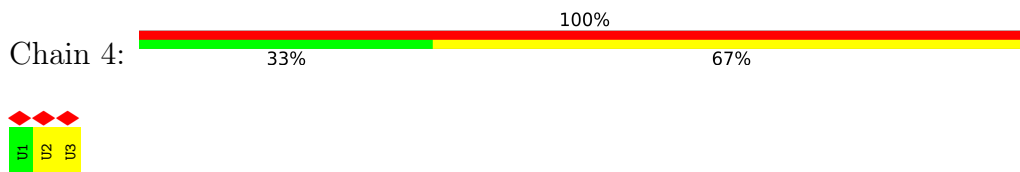

- Molecule 2: THO complex subunit 1

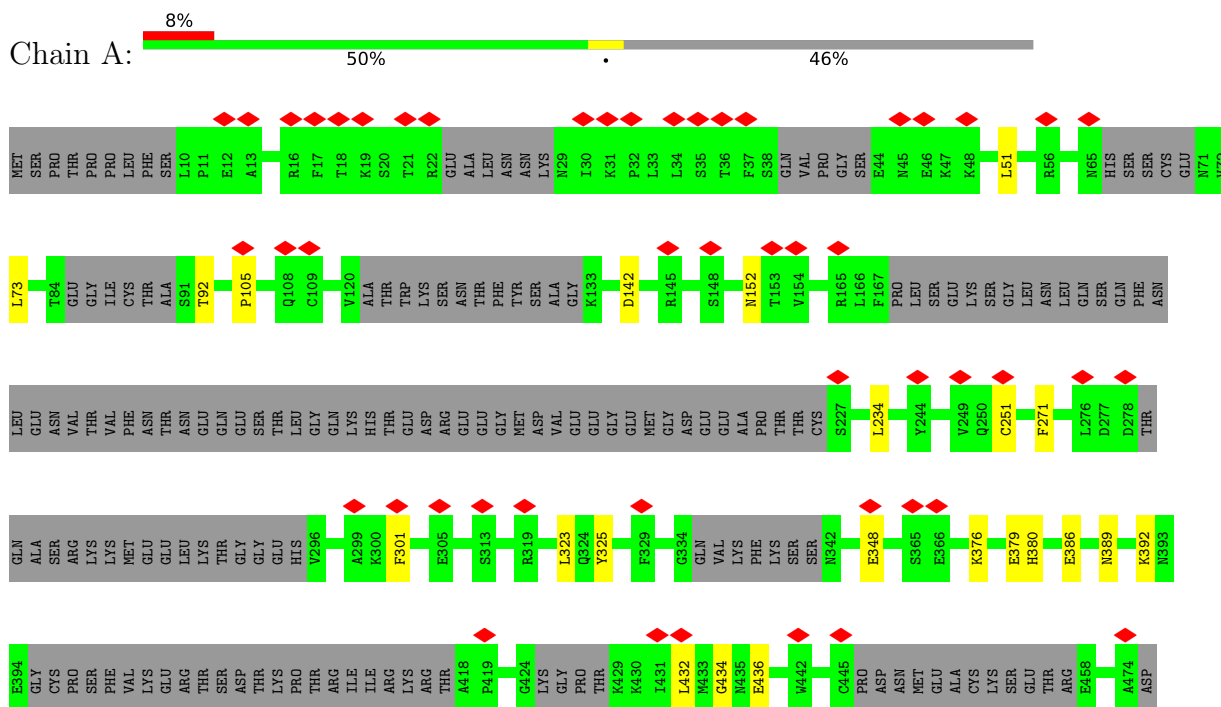

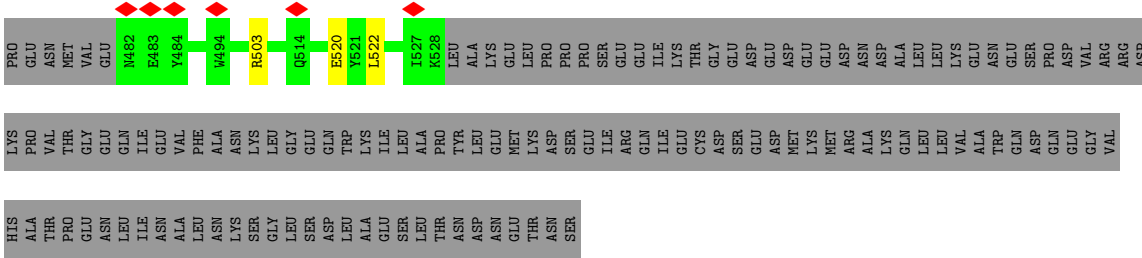

• Molecule 2: THO complex subunit 1

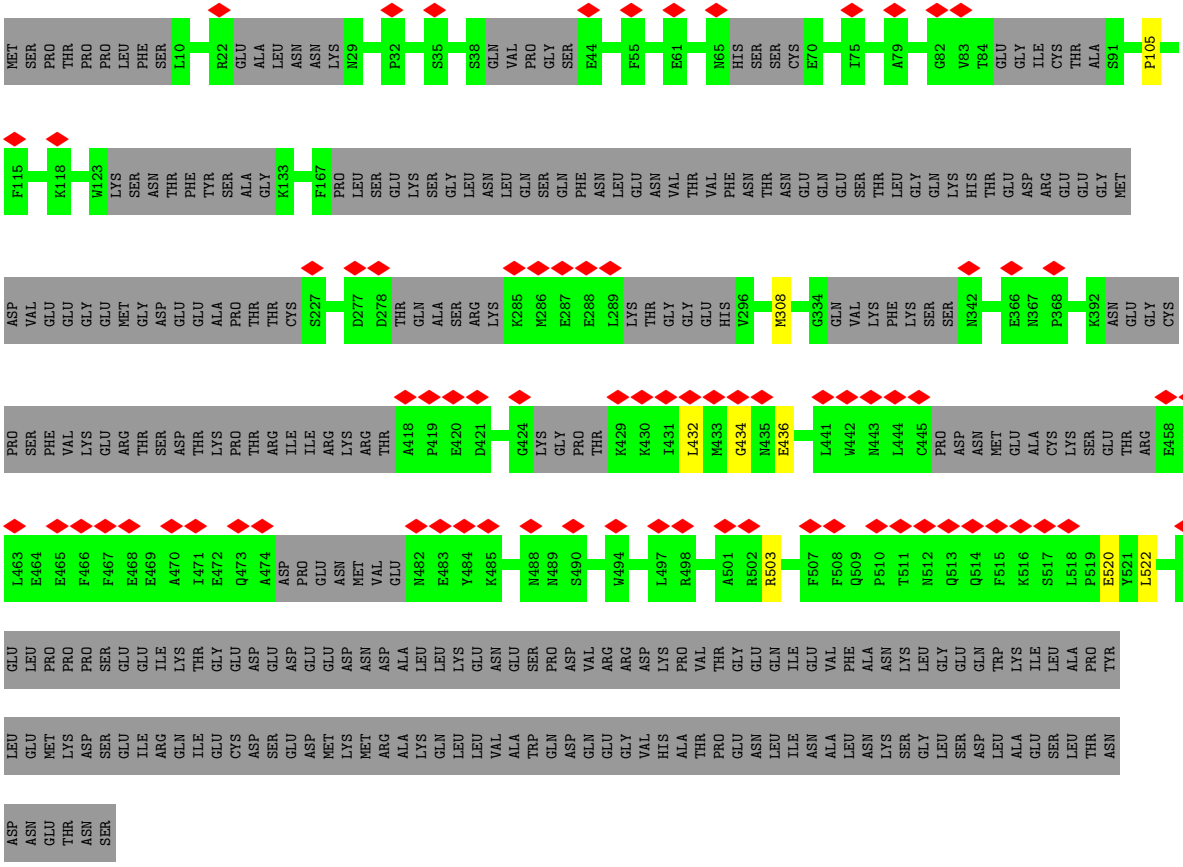

• Molecule 2: THO complex subunit 1

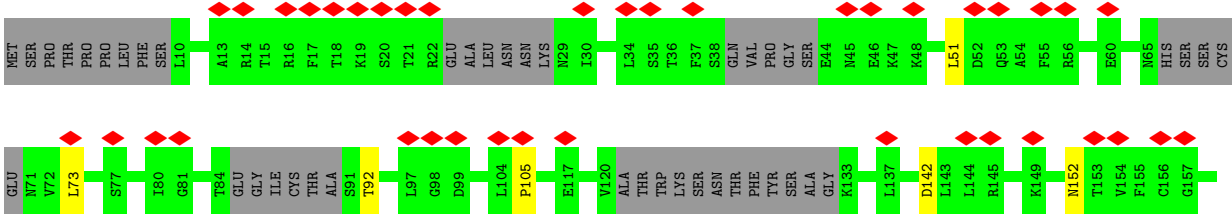

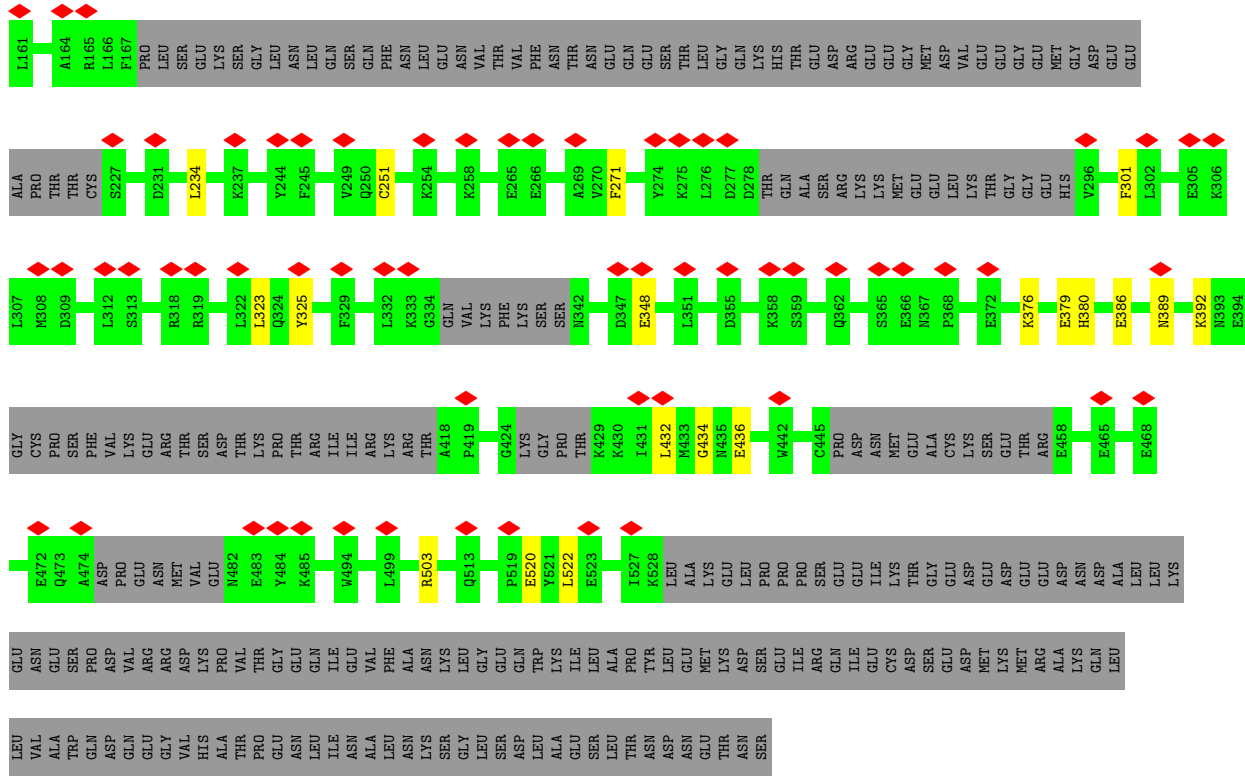

• Molecule 2: THO complex subunit 1

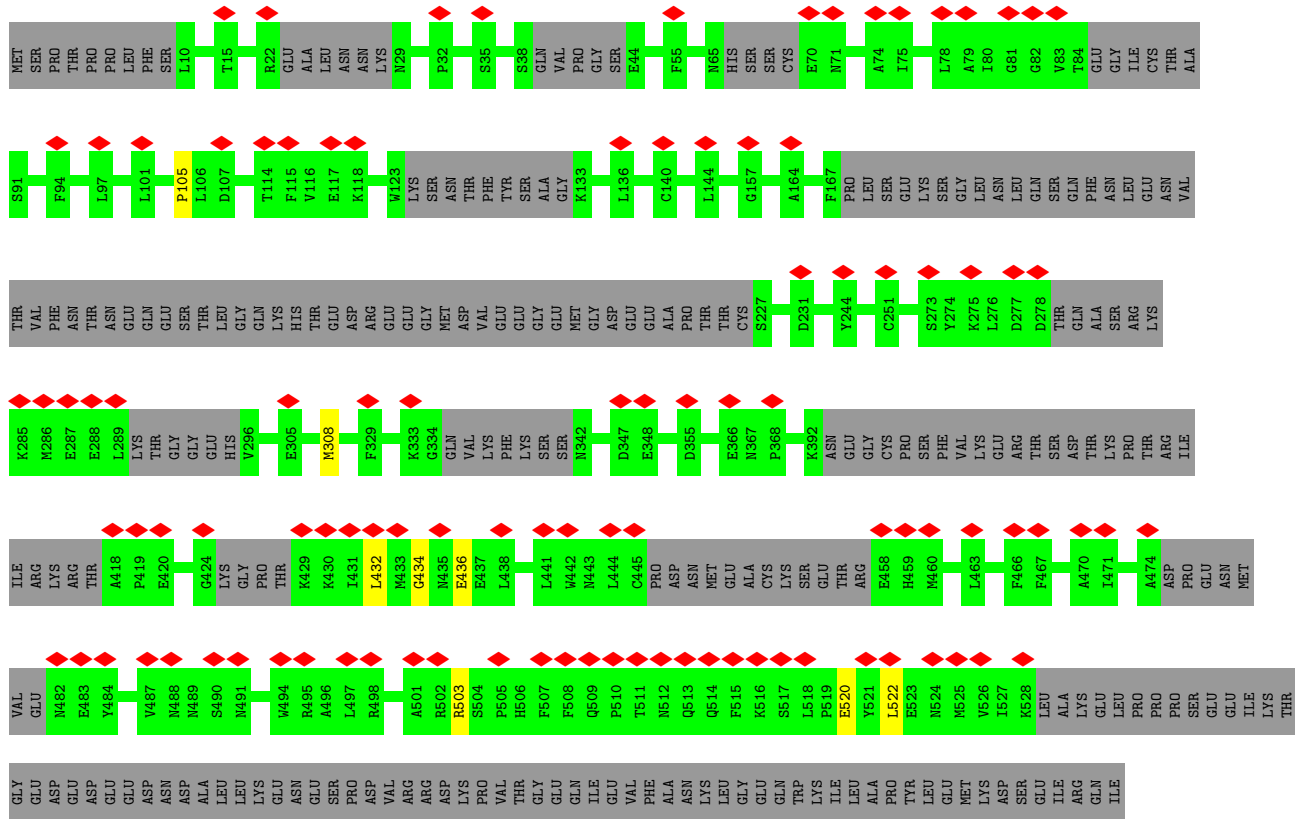

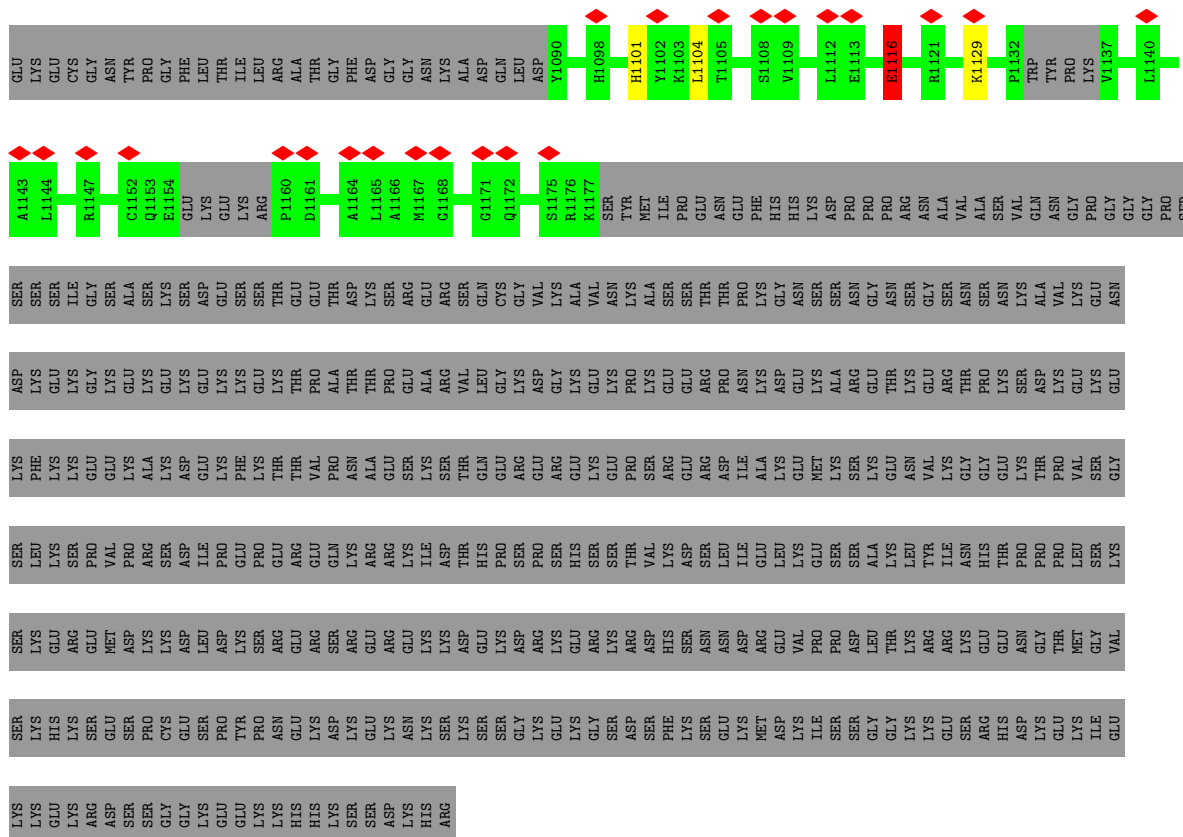

• Molecule 3: THO complex subunit 2

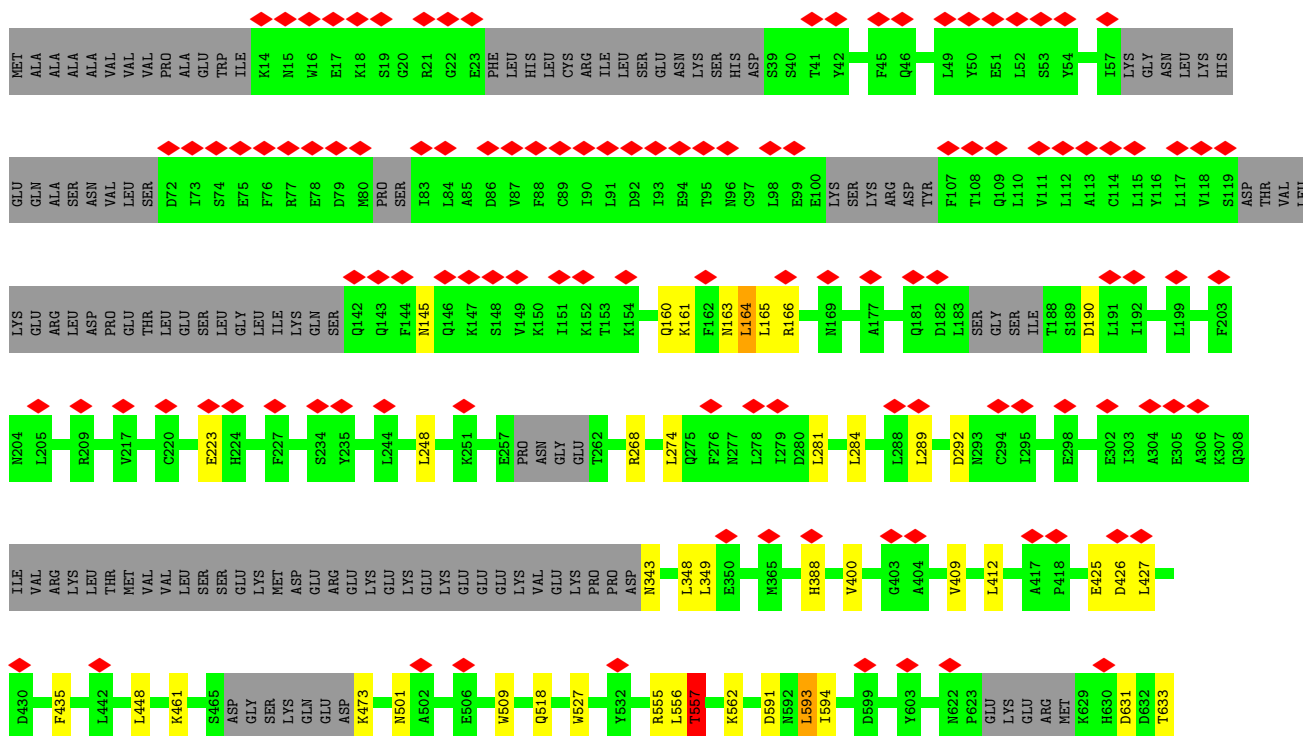

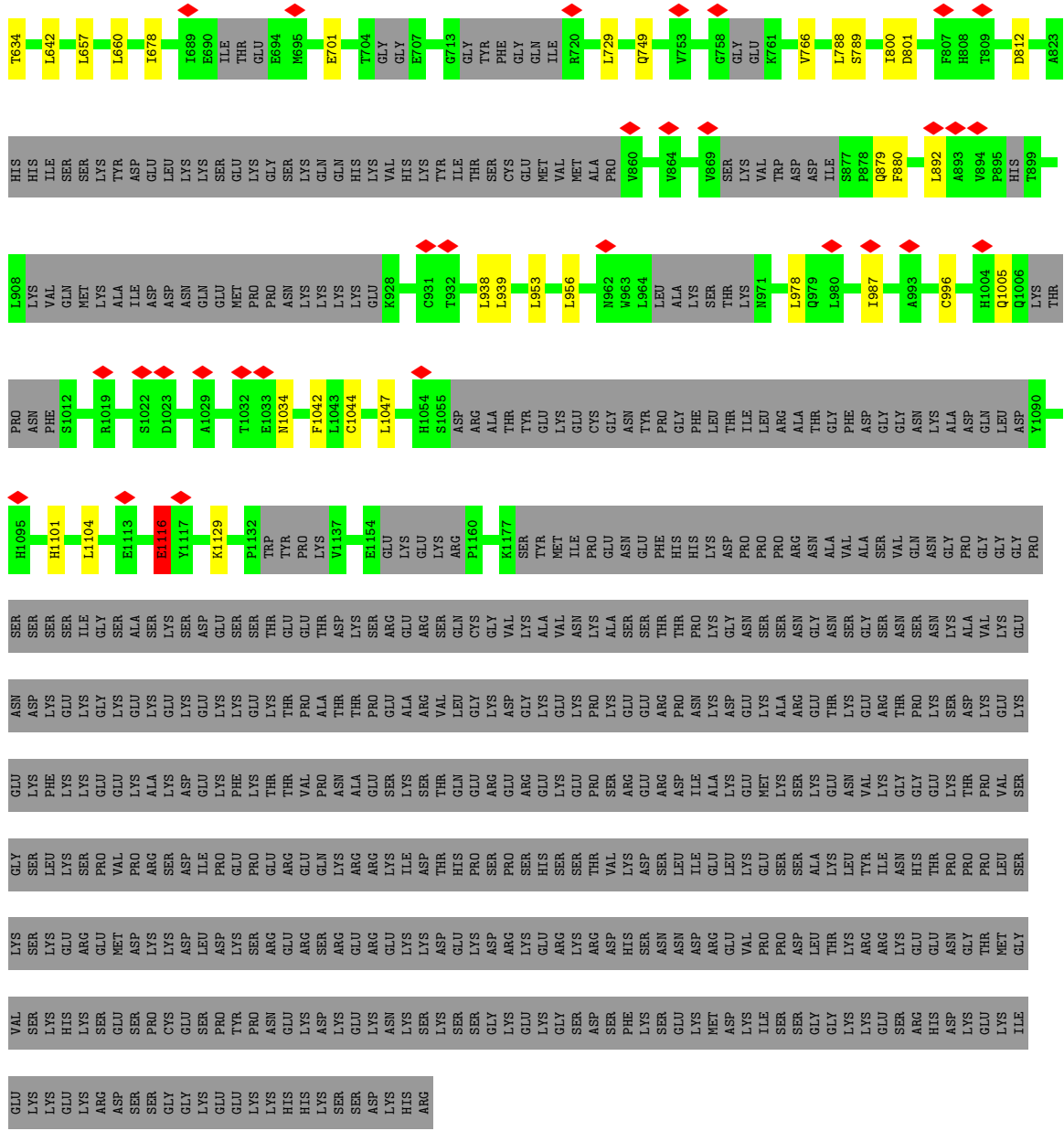

● Molecule 3: THO complex subunit 2

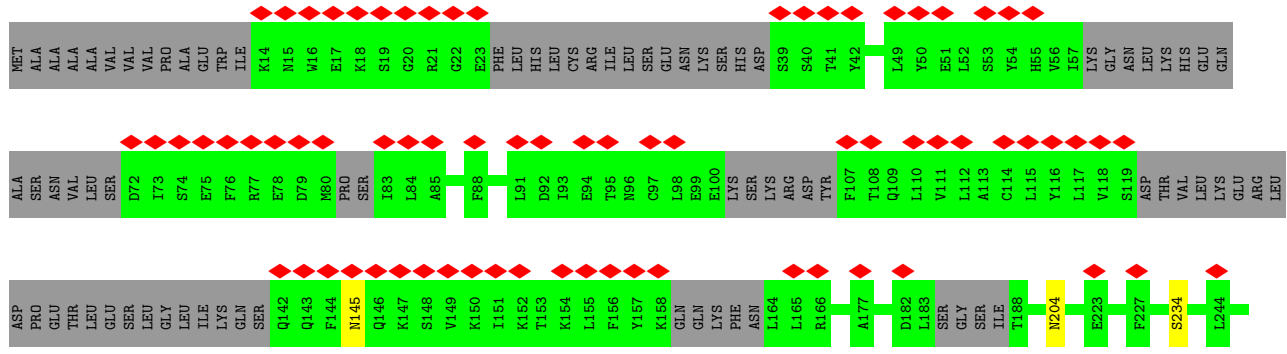

LYS ASP
GLU VAL
LYS SER
LYS ASP
ARG GLY
LYS ARG
GLU LYS
ARG LYS
LYS ASP
ARG ASP
ASP ASP
HIS HIS
SER SER
ASN ASN
GLY ASP
LYS ASP
ARG MET
GLY ASP
GLU VAL
PRO ILE
PRO SER
PRO ASP
ASP GLY
LEU THR
LYS THR
LYS ARG
ARG LYS
LYS ARG
GLY GLY
GLU HIS
GLU ASP
ASN ASN

SER LYS
SER SER
SER GLY
GLY LYS
GLU LYS
LYS ASP
SER ASP
SER PHE
HIS LYS
SER SER
ASN ASN
GLY ASP
LYS MET
GLY ASP
GLU VAL
PRO ILE
PRO SER
PRO ASP
ASP GLY
LEU THR
LYS THR
LYS ARG
ARG LYS
LYS ARG
GLY GLY
GLU HIS
GLU ASP
ASN ASN

ARG

● Molecule 4: THO complex subunit 3

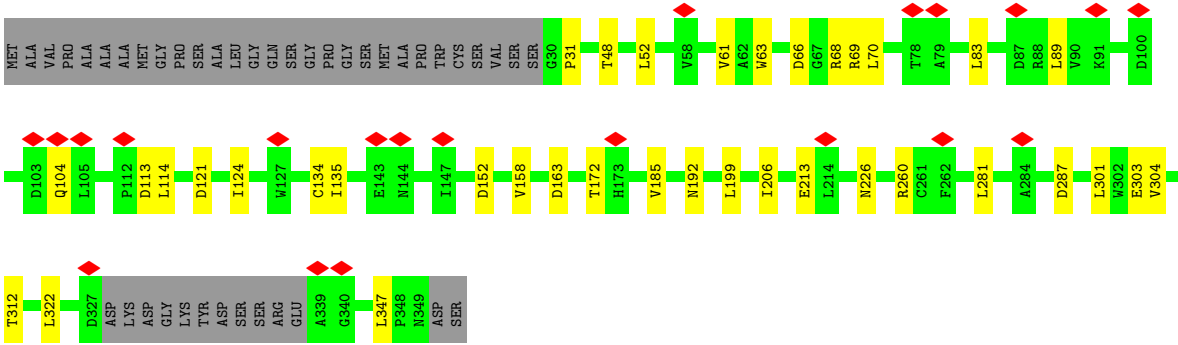
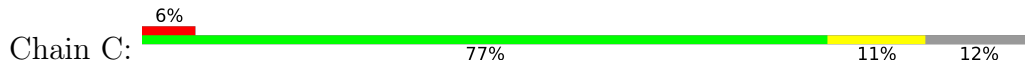

● Molecule 4: THO complex subunit 3

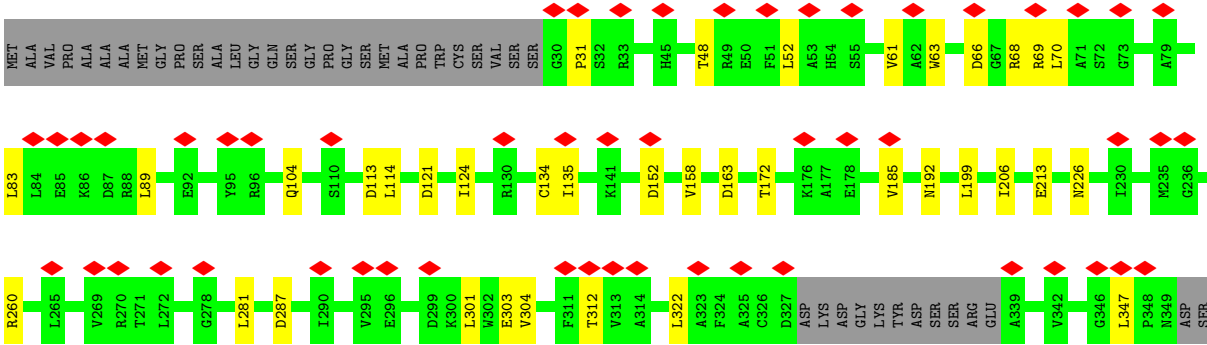
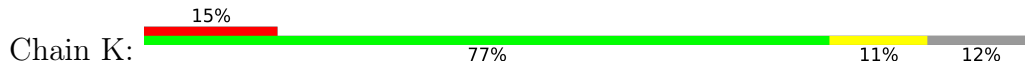

● Molecule 4: THO complex subunit 3

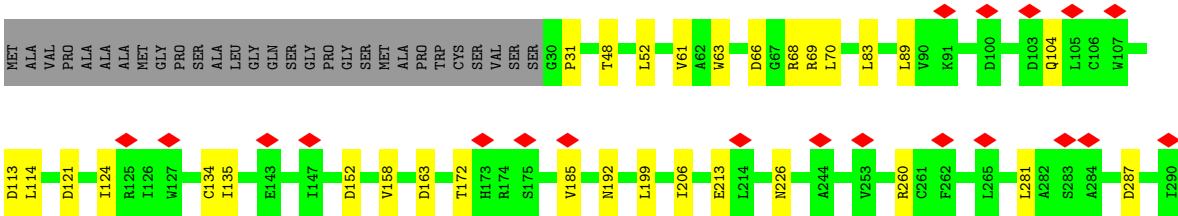
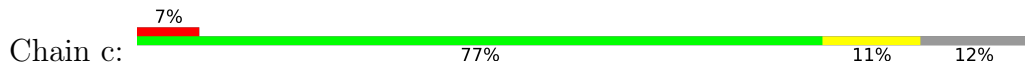

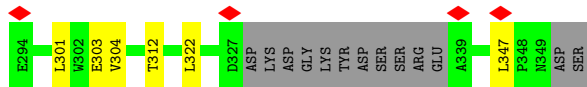

• Molecule 4: THO complex subunit 3

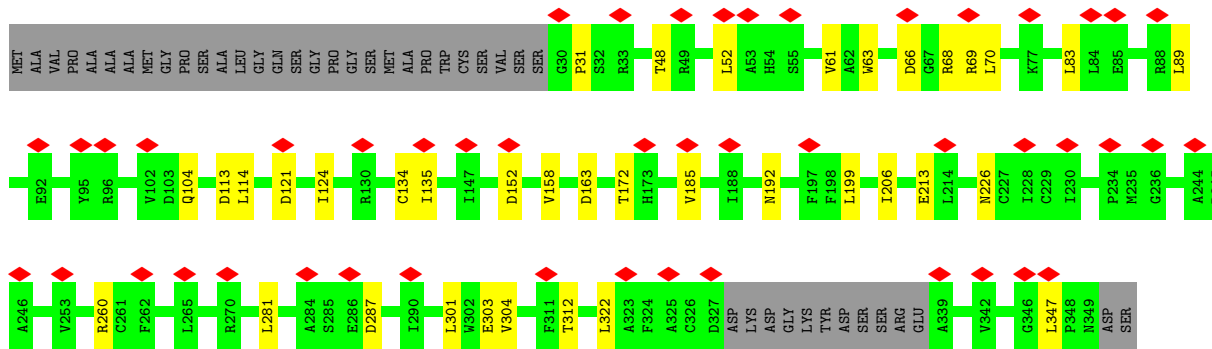
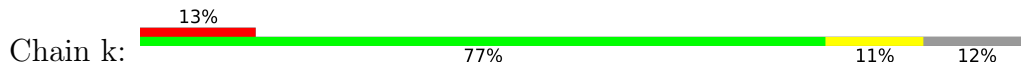

• Molecule 5: THO complex subunit 5 homolog

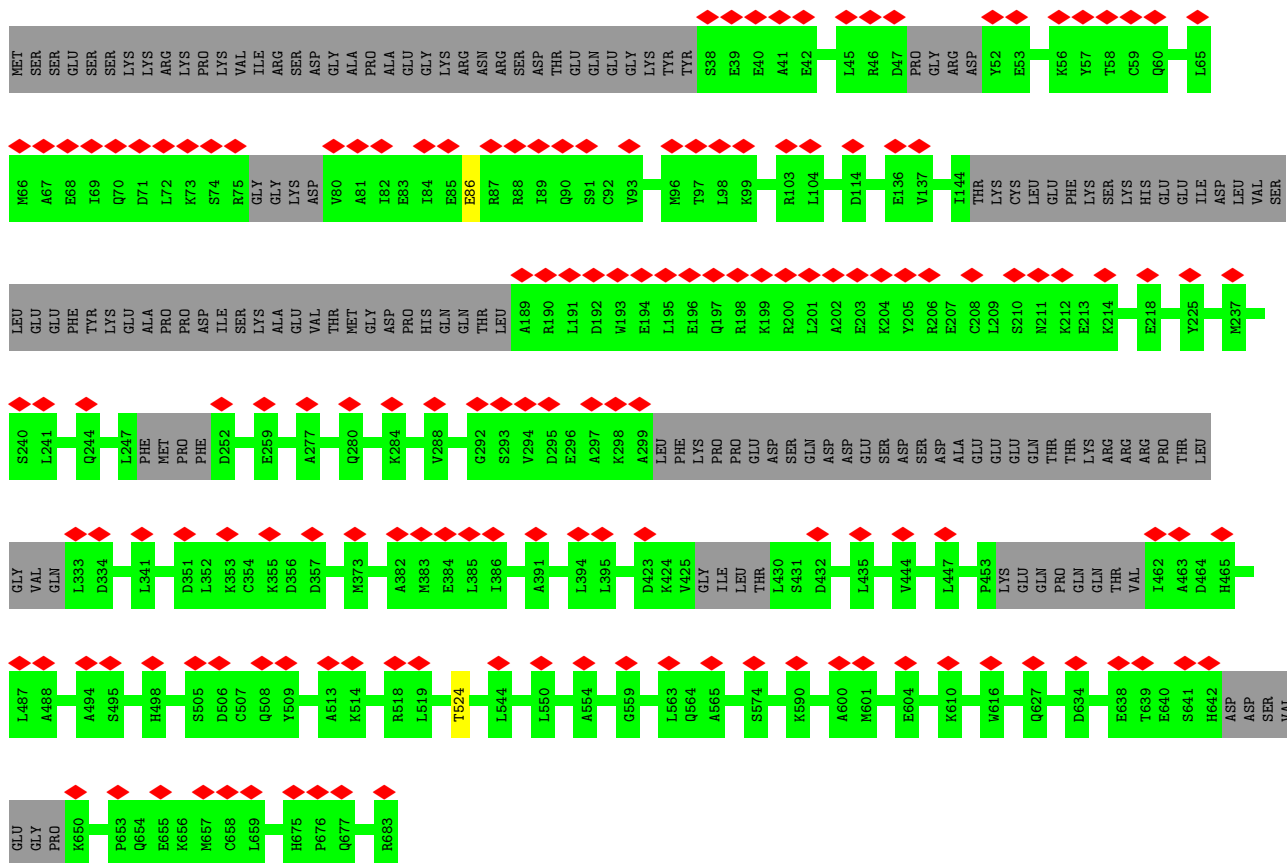
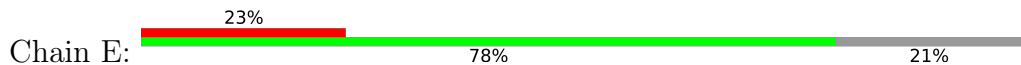

• Molecule 5: THO complex subunit 5 homolog

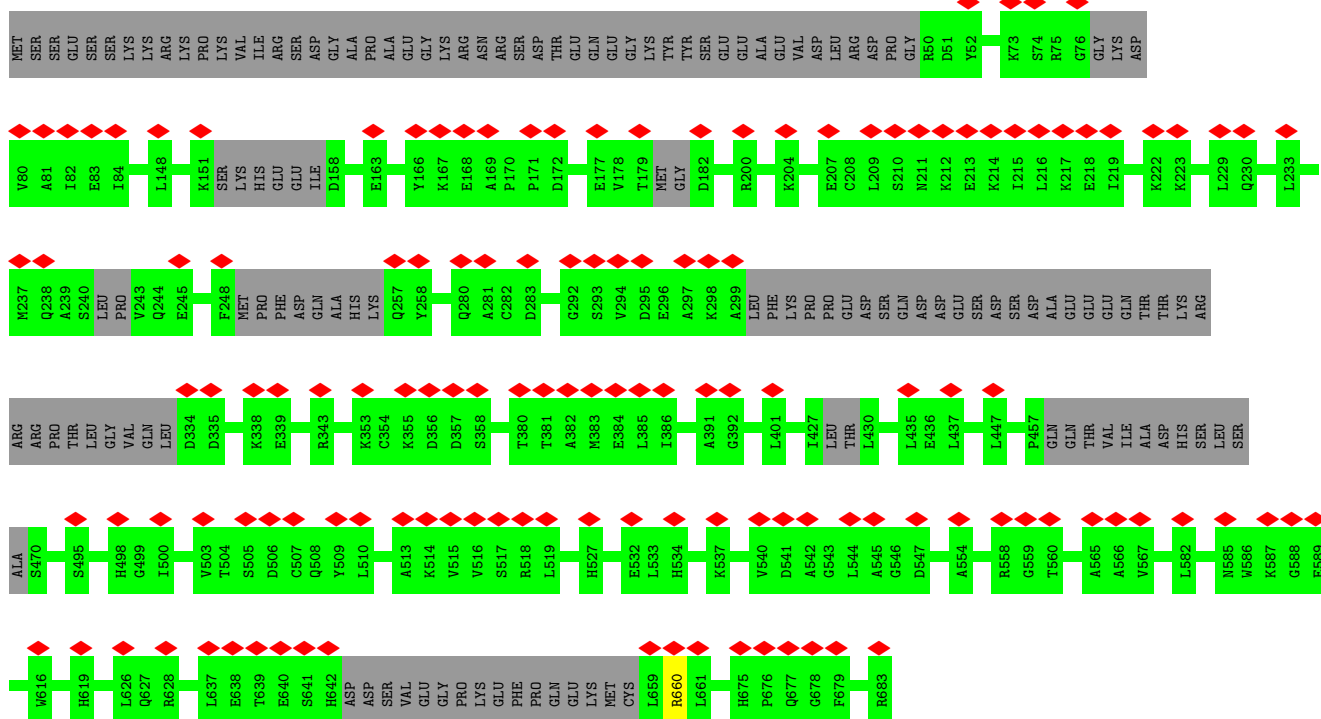
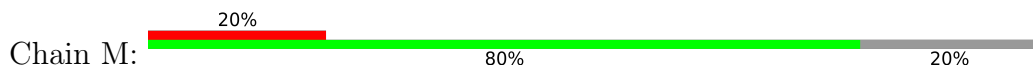

• Molecule 5: THO complex subunit 5 homolog

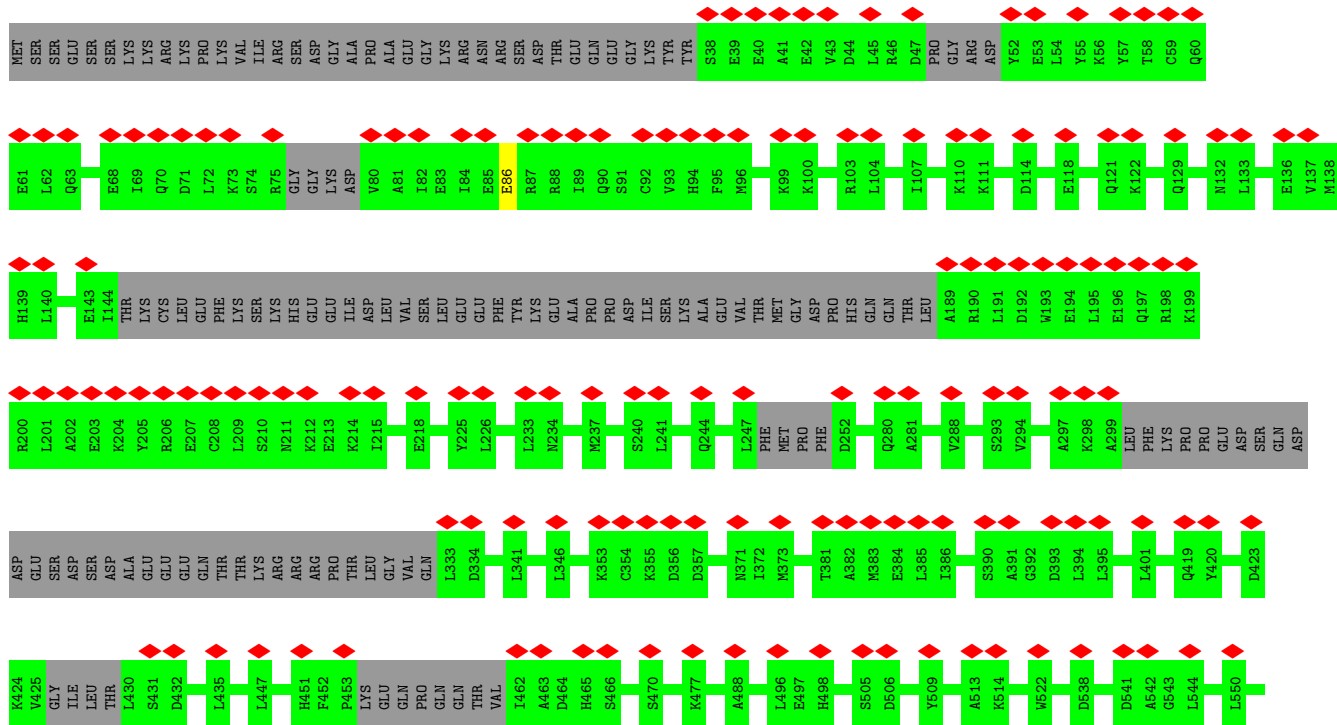
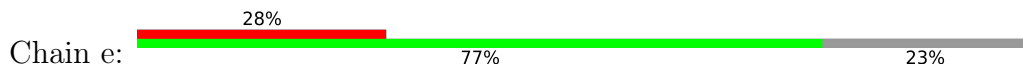

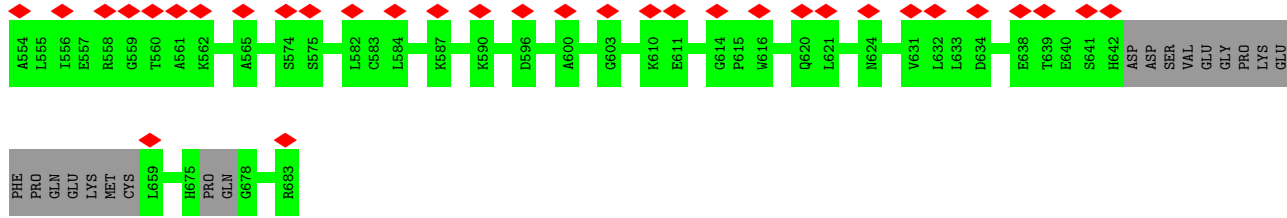

• Molecule 5: THO complex subunit 5 homolog

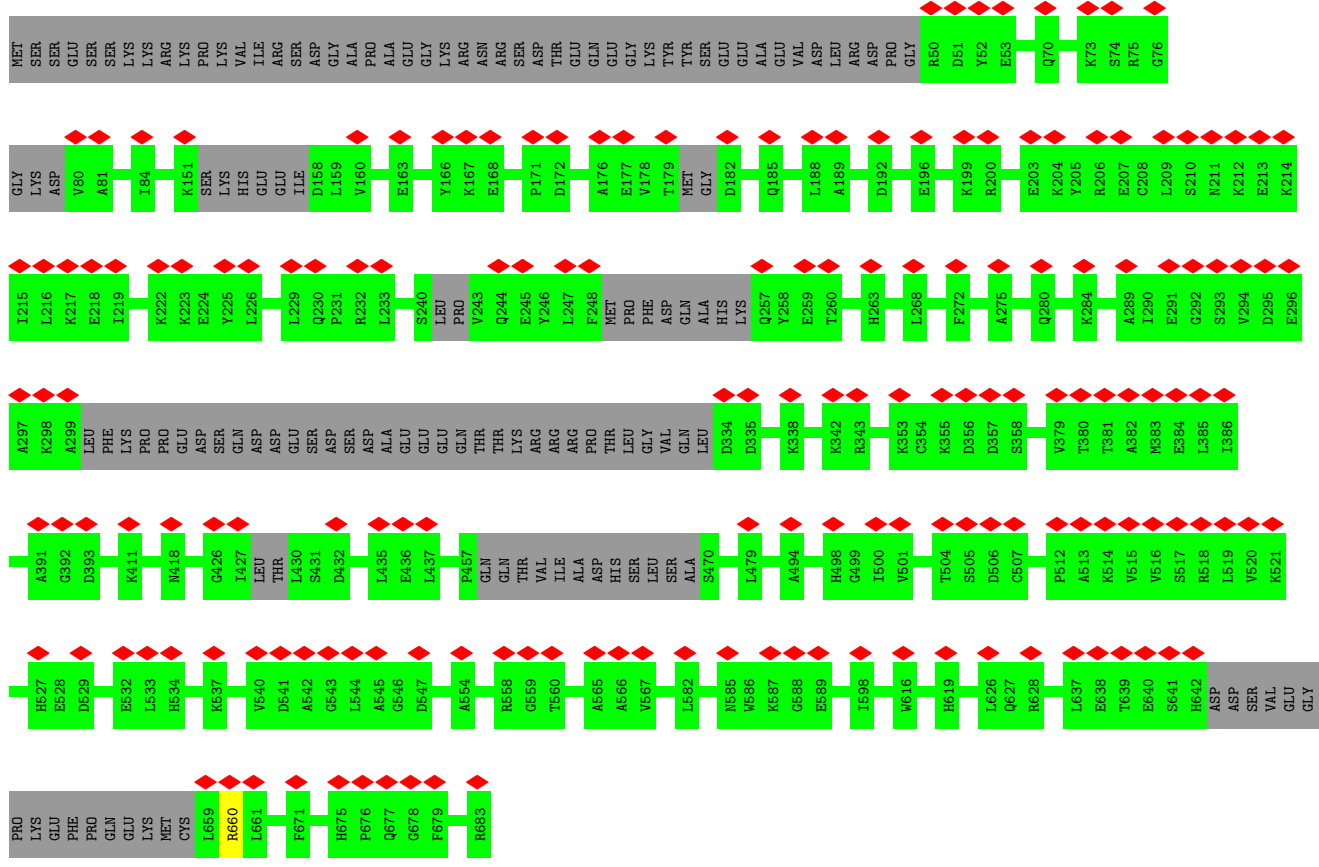
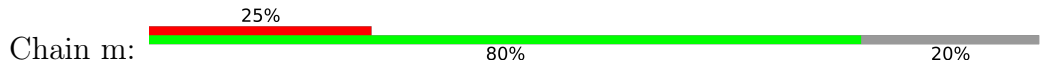

• Molecule 6: THO complex subunit 6 homolog

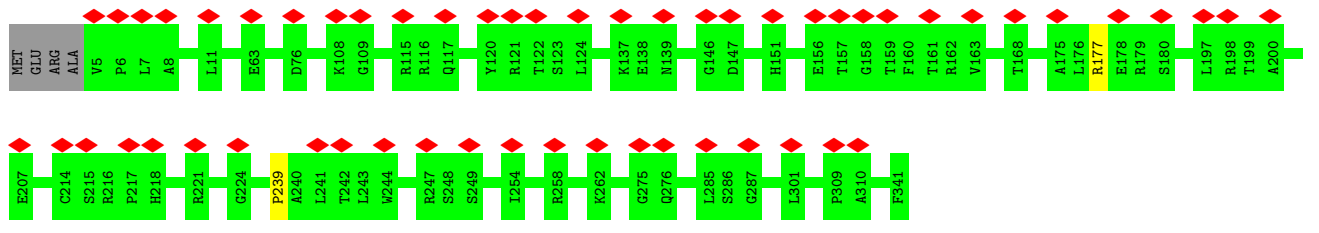

• Molecule 6: THO complex subunit 6 homolog

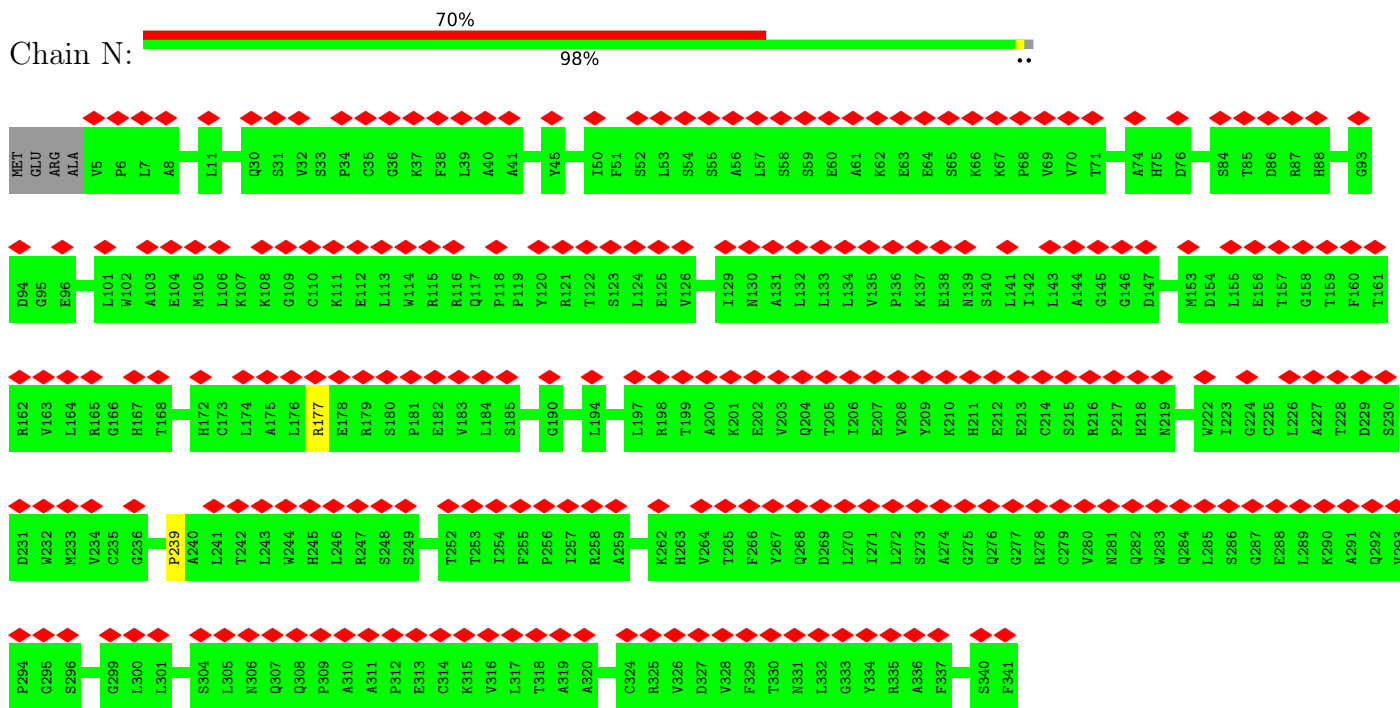

• Molecule 6: THO complex subunit 6 homolog

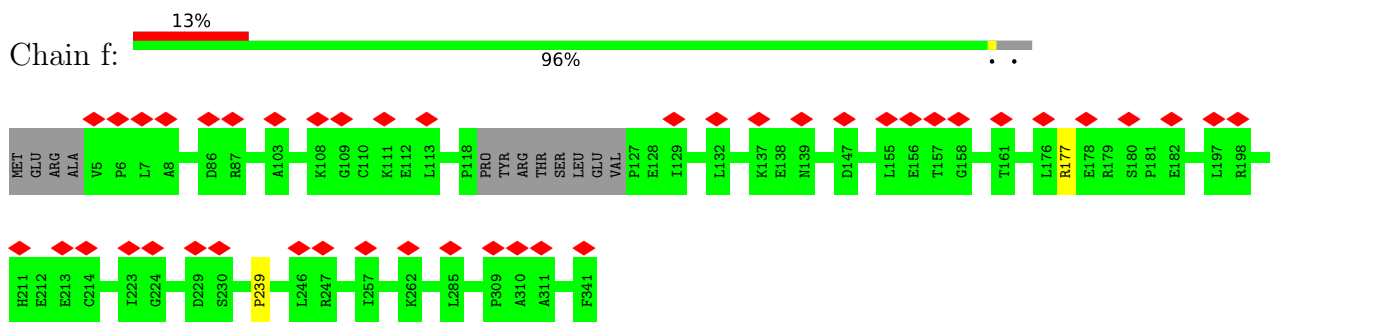

• Molecule 6: THO complex subunit 6 homolog

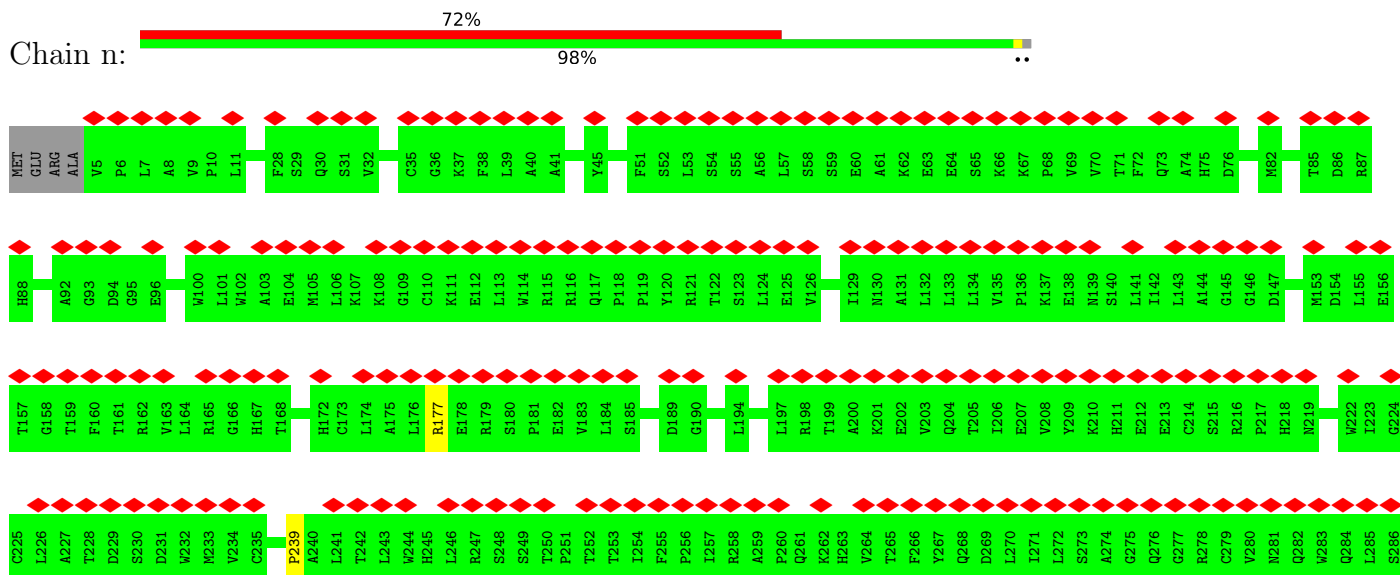

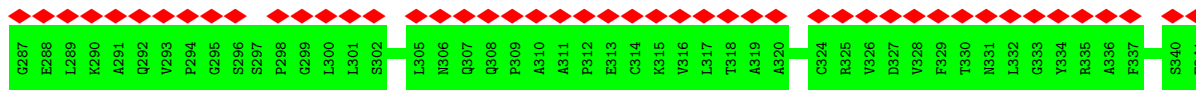

• Molecule 7: THO complex subunit 7 homolog

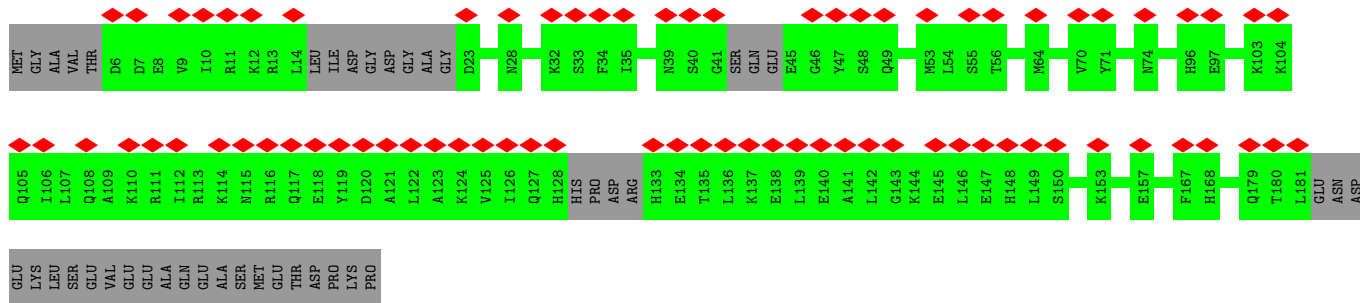
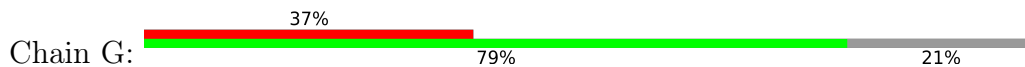

• Molecule 7: THO complex subunit 7 homolog

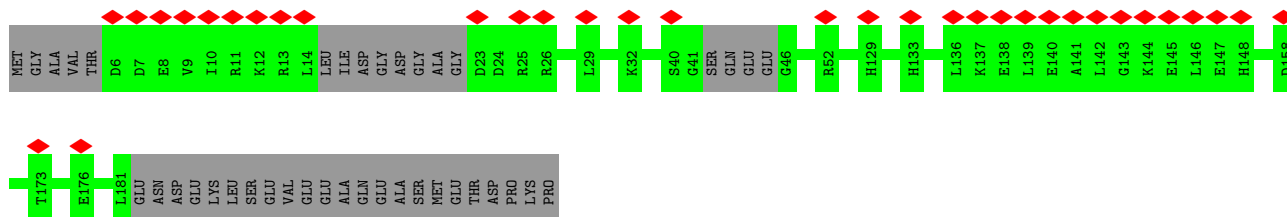
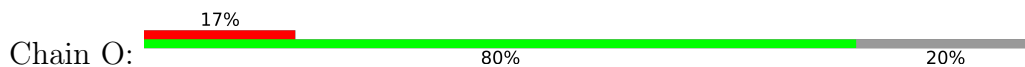

• Molecule 7: THO complex subunit 7 homolog

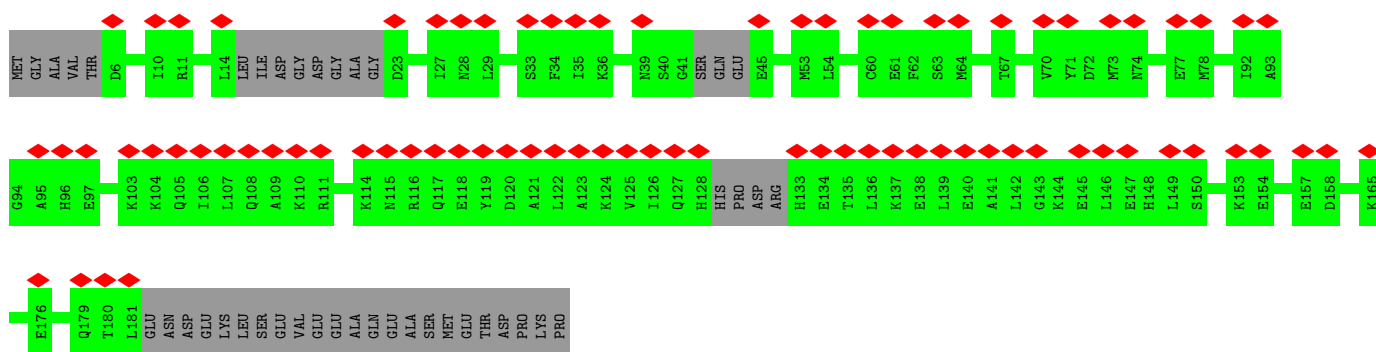
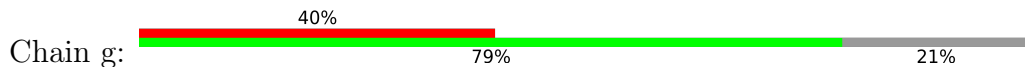

• Molecule 7: THO complex subunit 7 homolog

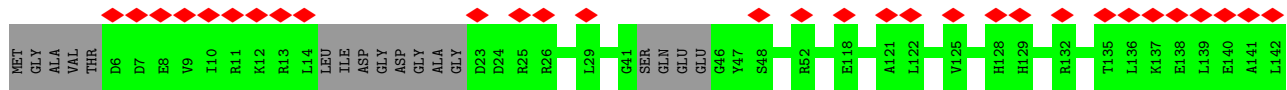
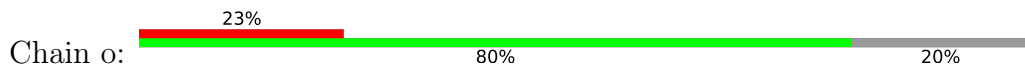

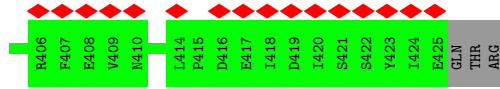

• Molecule 9: THO complex subunit 4



MET	ALA	ASP	LYS	MET	ASP	MET	SER	LEU	ASP	ASP	ILE	ILE	LYS	LEU	ASN	ARG	SER	SER	GLN	ARG	GLY	GLY	GLY	GLY	GLY	GLY	GLN	THR	ARG
ILE	ALA	ARG	GLY	ALA	ALA	GLY	GLY	GLY	GLY	ARG	GLY	ASN	ARG	PRO	PRO	ALA	TYR	SER	ARG	PRO	ARG	LYS	GLY	GLY	GLY	GLY	GLY	THR	ALA
ASP	ILE	GLN	GLU	LEU	PHE	ALA	GLU	PHE	THR	THR	LEU	LYS	LYS	ALA	ALA	VAL	HIS	TYR	ASP	ASP	LEU	SER	LEU	LEU	LEU	ALA	MET	GLN	ALA
VAL	THR	SER	GLN	ILE	ASP	ALA	GLN	ARG	ARG	PRO	ALA	GLN	SER	VAL	ASN	ARG	GLY	GLY	MET	THR	THR	GLY	ALA	GLY	THR	GLY	ARG	GLY	A240
E241	E242	L243	D244	A245	Q246	L247	D248	A249	Y250	N251	A252	R253	M254	D255	THR	SER													

• Molecule 9: THO complex subunit 4



MET	ALA	ASP	LYS	MET	ASP	MET	SER	LEU	ASP	ASP	ILE	ILE	LYS	LEU	ASN	ARG	SER	SER	GLN	ARG	GLY	GLY	GLY	GLY	GLY	GLY	GLN	THR	ARG
ILE	ALA	ARG	GLY	ALA	ALA	GLY	GLY	GLY	GLY	ARG	ASN	ARG	PRO	PRO	ALA	TYR	SER	ARG	PRO	ARG	LYS	GLY	GLY	GLY	GLY	GLY	THR	ALA	ALA
ASP	ILE	GLN	GLU	LEU	PHE	ALA	GLU	PHE	THR	THR	LEU	LYS	LYS	ALA	ALA	VAL	HIS	TYR	ASP	ASP	LEU	SER	LEU	LEU	LEU	ALA	MET	GLN	ALA
VAL	THR	SER	GLN	ILE	ASP	ALA	GLN	ARG	ARG	PRO	ALA	GLN	SER	VAL	ASN	ARG	GLY	GLY	MET	THR	THR	GLY	ALA	GLY	THR	GLY	ARG	GLY	A240
E241	E242	L243	D244	A245	Q246	L247	D248	A249	Y250	N251	A252	R253	M254	D255	THR	SER													

4 Experimental information

Property	Value	Source
EM reconstruction method	SINGLE PARTICLE	Depositor
Imposed symmetry	POINT, Not provided	
Number of particles used	182534	Depositor
Resolution determination method	FSC 0.143 CUT-OFF	Depositor
CTF correction method	PHASE FLIPPING AND AMPLITUDE CORRECTION	Depositor
Microscope	FEI TITAN KRIOS	Depositor
Voltage (kV)	300	Depositor
Electron dose ($e^-/\text{\AA}^2$)	60	Depositor
Minimum defocus (nm)	500	Depositor
Maximum defocus (nm)	2000	Depositor
Magnification	Not provided	
Image detector	GATAN K3 (6k x 4k)	Depositor
Maximum map value	11.951	Depositor
Minimum map value	0.000	Depositor
Average map value	0.014	Depositor
Map value standard deviation	0.146	Depositor
Recommended contour level	1.0	Depositor
Map size (\AA)	586.56, 586.56, 586.56	wwPDB
Map dimensions	416, 416, 416	wwPDB
Map angles ($^\circ$)	90.0, 90.0, 90.0	wwPDB
Pixel spacing (\AA)	1.41, 1.41, 1.41	Depositor

5 Model quality [i](#)

5.1 Standard geometry [i](#)

The Z score for a bond length (or angle) is the number of standard deviations the observed value is removed from the expected value. A bond length (or angle) with $|Z| > 5$ is considered an outlier worth inspection. RMSZ is the root-mean-square of all Z scores of the bond lengths (or angles).

Mol	Chain	Bond lengths		Bond angles	
		RMSZ	# Z >5	RMSZ	# Z >5
1	2	0.16	0/65	0.67	0/98
1	4	0.15	0/65	0.66	0/98
2	A	0.26	0/2942	0.38	0/3969
2	I	0.29	0/2989	0.46	0/4034
2	a	0.26	0/2942	0.38	0/3969
2	i	0.28	0/2990	0.46	0/4035
3	B	0.28	0/7129	0.43	1/9633 (0.0%)
3	J	0.28	1/7071 (0.0%)	0.44	1/9556 (0.0%)
3	b	0.28	0/7129	0.43	1/9633 (0.0%)
3	j	0.28	1/7071 (0.0%)	0.43	1/9556 (0.0%)
4	C	0.32	0/2494	0.49	0/3384
4	K	0.32	0/2494	0.49	0/3384
4	c	0.32	0/2494	0.49	0/3384
4	k	0.32	0/2494	0.49	0/3384
5	E	0.34	1/3832 (0.0%)	0.49	0/5227
5	M	0.29	0/4217	0.49	0/5719
5	e	0.34	1/3739 (0.0%)	0.48	0/5100
5	m	0.29	0/4217	0.49	0/5719
6	F	0.32	0/2666	0.57	0/3623
6	N	0.32	0/2666	0.56	0/3623
6	f	0.33	0/2596	0.57	0/3524
6	n	0.33	0/2666	0.57	0/3623
7	G	0.24	0/796	0.30	0/1105
7	O	0.27	0/1138	0.39	0/1536
7	g	0.24	0/796	0.30	0/1105
7	o	0.27	0/1138	0.39	0/1536
8	H	0.25	0/1421	0.39	0/1915
8	P	0.66	0/3025	0.82	2/4070 (0.0%)
8	h	0.25	0/1421	0.39	0/1915
8	p	0.66	0/3025	0.82	2/4070 (0.0%)
9	L	1.42	1/79 (1.3%)	1.17	2/109 (1.8%)
9	l	1.42	1/79 (1.3%)	1.17	2/109 (1.8%)
All	All	0.34	6/89886 (0.0%)	0.50	12/121745 (0.0%)

Chiral center outliers are detected by calculating the chiral volume of a chiral center and verifying if the center is modelled as a planar moiety or with the opposite hand. A planarity outlier is detected by checking planarity of atoms in a peptide group, atoms in a mainchain group or atoms of a sidechain that are expected to be planar.

Mol	Chain	#Chirality outliers	#Planarity outliers
3	B	0	5
3	J	0	4
3	b	0	5
3	j	0	4
4	C	0	1
4	K	0	1
4	c	0	1
4	k	0	1
5	M	0	1
5	m	0	1
All	All	0	24

All (6) bond length outliers are listed below:

Mol	Chain	Res	Type	Atoms	Z	Observed(Å)	Ideal(Å)
5	e	86	GLU	C-N	-10.04	1.10	1.34
5	E	86	GLU	C-N	-9.98	1.11	1.34
3	j	234	SER	C-N	-5.82	1.20	1.34
3	J	234	SER	C-N	-5.80	1.20	1.34
9	l	253	ARG	C-N	-5.75	1.20	1.34
9	L	253	ARG	C-N	-5.73	1.20	1.34

All (12) bond angle outliers are listed below:

Mol	Chain	Res	Type	Atoms	Z	Observed(°)	Ideal(°)
9	l	253	ARG	O-C-N	-6.68	112.01	122.70
9	L	253	ARG	O-C-N	-6.68	112.02	122.70
3	J	593	LEU	CA-CB-CG	6.33	129.85	115.30
3	j	593	LEU	CA-CB-CG	6.31	129.82	115.30
3	B	593	LEU	CA-CB-CG	6.29	129.76	115.30
3	b	593	LEU	CA-CB-CG	6.28	129.74	115.30
8	P	139	TYR	CA-CB-CG	-5.71	102.56	113.40
8	p	139	TYR	CA-CB-CG	-5.65	102.66	113.40
8	p	164	ASN	C-N-CA	5.10	134.45	121.70
8	P	164	ASN	C-N-CA	5.09	134.44	121.70
9	l	253	ARG	C-N-CA	5.05	134.32	121.70
9	L	253	ARG	C-N-CA	5.04	134.29	121.70

There are no chirality outliers.

All (24) planarity outliers are listed below:

Mol	Chain	Res	Type	Group
3	B	1116	GLU	Peptide
3	B	163	ASN	Peptide
3	B	557	THR	Peptide
3	B	562	LYS	Peptide
3	B	788	LEU	Peptide
4	C	287	ASP	Peptide
3	J	1116	GLU	Peptide
3	J	557	THR	Peptide
3	J	562	LYS	Peptide
3	J	788	LEU	Peptide
4	K	287	ASP	Peptide
5	M	660	ARG	Peptide
3	b	1116	GLU	Peptide
3	b	163	ASN	Peptide
3	b	557	THR	Peptide
3	b	562	LYS	Peptide
3	b	788	LEU	Peptide
4	c	287	ASP	Peptide
3	j	1116	GLU	Peptide
3	j	557	THR	Peptide
3	j	562	LYS	Peptide
3	j	788	LEU	Peptide
4	k	287	ASP	Peptide
5	m	660	ARG	Peptide

5.2 Too-close contacts [i](#)

Due to software issues we are unable to calculate clashes - this section is therefore empty.

5.3 Torsion angles [i](#)

5.3.1 Protein backbone [i](#)

In the following table, the Percentiles column shows the percent Ramachandran outliers of the chain as a percentile score with respect to all PDB entries followed by that with respect to all EM entries.

The Analysed column shows the number of residues for which the backbone conformation was analysed, and the total number of residues.

Mol	Chain	Analysed	Favoured	Allowed	Outliers	Percentiles	
2	A	330/657 (50%)	308 (93%)	20 (6%)	2 (1%)	25	63
2	I	335/657 (51%)	309 (92%)	23 (7%)	3 (1%)	17	54
2	a	330/657 (50%)	309 (94%)	19 (6%)	2 (1%)	25	63
2	i	335/657 (51%)	309 (92%)	23 (7%)	3 (1%)	17	54
3	B	871/1593 (55%)	805 (92%)	62 (7%)	4 (0%)	29	67
3	J	864/1593 (54%)	802 (93%)	59 (7%)	3 (0%)	41	75
3	b	871/1593 (55%)	804 (92%)	63 (7%)	4 (0%)	29	67
3	j	864/1593 (54%)	802 (93%)	59 (7%)	3 (0%)	41	75
4	C	305/351 (87%)	268 (88%)	36 (12%)	1 (0%)	41	75
4	K	305/351 (87%)	268 (88%)	36 (12%)	1 (0%)	41	75
4	c	305/351 (87%)	267 (88%)	37 (12%)	1 (0%)	41	75
4	k	305/351 (87%)	269 (88%)	35 (12%)	1 (0%)	41	75
5	E	520/683 (76%)	494 (95%)	26 (5%)	0	100	100
5	M	529/683 (78%)	504 (95%)	25 (5%)	0	100	100
5	e	507/683 (74%)	484 (96%)	23 (4%)	0	100	100
5	m	529/683 (78%)	504 (95%)	25 (5%)	0	100	100
6	F	335/341 (98%)	305 (91%)	29 (9%)	1 (0%)	41	75
6	N	335/341 (98%)	306 (91%)	28 (8%)	1 (0%)	41	75
6	f	325/341 (95%)	297 (91%)	27 (8%)	1 (0%)	41	75
6	n	335/341 (98%)	305 (91%)	29 (9%)	1 (0%)	41	75
7	G	153/204 (75%)	153 (100%)	0	0	100	100
7	O	158/204 (78%)	158 (100%)	0	0	100	100
7	g	153/204 (75%)	153 (100%)	0	0	100	100
7	o	158/204 (78%)	158 (100%)	0	0	100	100
8	H	168/428 (39%)	162 (96%)	6 (4%)	0	100	100
8	P	361/428 (84%)	351 (97%)	10 (3%)	0	100	100
8	h	168/428 (39%)	162 (96%)	6 (4%)	0	100	100
8	p	361/428 (84%)	351 (97%)	10 (3%)	0	100	100
9	L	14/257 (5%)	14 (100%)	0	0	100	100
9	l	14/257 (5%)	14 (100%)	0	0	100	100
All	All	11143/17542 (64%)	10395 (93%)	716 (6%)	32 (0%)	44	75

All (32) Ramachandran outliers are listed below:

Mol	Chain	Res	Type
3	B	789	SER
3	J	789	SER
3	b	789	SER
3	j	789	SER
3	B	557	THR
3	B	1116	GLU
2	I	308	MET
3	J	557	THR
3	J	1116	GLU
3	b	557	THR
3	b	1116	GLU
2	i	308	MET
3	j	557	THR
3	j	1116	GLU
3	B	164	LEU
2	I	105	PRO
3	b	164	LEU
2	i	105	PRO
4	C	31	PRO
4	K	31	PRO
4	c	31	PRO
4	k	31	PRO
6	F	239	PRO
6	N	239	PRO
6	f	239	PRO
6	n	239	PRO
2	A	105	PRO
2	A	434	GLY
2	I	434	GLY
2	a	105	PRO
2	a	434	GLY
2	i	434	GLY

5.3.2 Protein sidechains [i](#)

In the following table, the Percentiles column shows the percent sidechain outliers of the chain as a percentile score with respect to all PDB entries followed by that with respect to all EM entries.

The Analysed column shows the number of residues for which the sidechain conformation was analysed, and the total number of residues.

Mol	Chain	Analysed	Rotameric	Outliers	Percentiles	
2	A	310/601 (52%)	287 (93%)	23 (7%)	13	43
2	I	312/601 (52%)	307 (98%)	5 (2%)	62	79
2	a	310/601 (52%)	287 (93%)	23 (7%)	13	43
2	i	313/601 (52%)	308 (98%)	5 (2%)	62	79
3	B	704/1442 (49%)	633 (90%)	71 (10%)	7	30
3	J	697/1442 (48%)	631 (90%)	66 (10%)	8	33
3	b	704/1442 (49%)	632 (90%)	72 (10%)	7	30
3	j	697/1442 (48%)	632 (91%)	65 (9%)	9	34
4	C	268/300 (89%)	233 (87%)	35 (13%)	4	22
4	K	268/300 (89%)	233 (87%)	35 (13%)	4	22
4	c	268/300 (89%)	233 (87%)	35 (13%)	4	22
4	k	268/300 (89%)	233 (87%)	35 (13%)	4	22
5	E	322/615 (52%)	321 (100%)	1 (0%)	92	95
5	M	404/615 (66%)	404 (100%)	0	100	100
5	e	312/615 (51%)	312 (100%)	0	100	100
5	m	404/615 (66%)	404 (100%)	0	100	100
6	F	284/287 (99%)	283 (100%)	1 (0%)	91	94
6	N	284/287 (99%)	283 (100%)	1 (0%)	91	94
6	f	276/287 (96%)	275 (100%)	1 (0%)	91	94
6	n	284/287 (99%)	283 (100%)	1 (0%)	91	94
7	O	85/184 (46%)	85 (100%)	0	100	100
7	o	85/184 (46%)	85 (100%)	0	100	100
8	H	153/381 (40%)	153 (100%)	0	100	100
8	P	332/381 (87%)	331 (100%)	1 (0%)	92	95
8	h	153/381 (40%)	153 (100%)	0	100	100
8	p	332/381 (87%)	331 (100%)	1 (0%)	92	95
All	All	8829/14872 (59%)	8352 (95%)	477 (5%)	26	52

All (477) residues with a non-rotameric sidechain are listed below:

Mol	Chain	Res	Type
2	A	51	LEU
2	A	73	LEU
2	A	92	THR

Continued on next page...

Continued from previous page...

Mol	Chain	Res	Type
2	A	142	ASP
2	A	152	ASN
2	A	234	LEU
2	A	251	CYS
2	A	271	PHE
2	A	301	PHE
2	A	323	LEU
2	A	325	TYR
2	A	348	GLU
2	A	376	LYS
2	A	379	GLU
2	A	380	HIS
2	A	386	GLU
2	A	389	ASN
2	A	392	LYS
2	A	432	LEU
2	A	436	GLU
2	A	503	ARG
2	A	520	GLU
2	A	522	LEU
3	B	145	ASN
3	B	160	GLN
3	B	161	LYS
3	B	164	LEU
3	B	165	LEU
3	B	166	ARG
3	B	190	ASP
3	B	223	GLU
3	B	248	LEU
3	B	268	ARG
3	B	274	LEU
3	B	281	LEU
3	B	284	LEU
3	B	289	LEU
3	B	292	ASP
3	B	343	ASN
3	B	348	LEU
3	B	349	LEU
3	B	388	HIS
3	B	400	VAL
3	B	409	VAL
3	B	412	LEU

Continued on next page...

Continued from previous page...

Mol	Chain	Res	Type
3	B	425	GLU
3	B	426	ASP
3	B	427	LEU
3	B	435	PHE
3	B	448	LEU
3	B	461	LYS
3	B	473	LYS
3	B	501	ASN
3	B	509	TRP
3	B	518	GLN
3	B	527	TRP
3	B	555	ARG
3	B	556	LEU
3	B	557	THR
3	B	591	ASP
3	B	593	LEU
3	B	594	ILE
3	B	631	ASP
3	B	633	THR
3	B	634	THR
3	B	642	LEU
3	B	657	LEU
3	B	660	LEU
3	B	678	ILE
3	B	729	LEU
3	B	749	GLN
3	B	766	VAL
3	B	800	ILE
3	B	801	ASP
3	B	812	ASP
3	B	879	GLN
3	B	880	PHE
3	B	892	LEU
3	B	938	LEU
3	B	939	LEU
3	B	953	LEU
3	B	956	LEU
3	B	978	LEU
3	B	987	ILE
3	B	996	CYS
3	B	1005	GLN
3	B	1034	ASN

Continued on next page...

Continued from previous page...

Mol	Chain	Res	Type
3	B	1042	PHE
3	B	1044	CYS
3	B	1047	LEU
3	B	1101	HIS
3	B	1104	LEU
3	B	1116	GLU
3	B	1129	LYS
4	C	48	THR
4	C	52	LEU
4	C	61	VAL
4	C	63	TRP
4	C	66	ASP
4	C	68	ARG
4	C	69	ARG
4	C	70	LEU
4	C	83	LEU
4	C	89	LEU
4	C	104	GLN
4	C	113	ASP
4	C	114	LEU
4	C	121	ASP
4	C	124	ILE
4	C	134	CYS
4	C	135	ILE
4	C	152	ASP
4	C	158	VAL
4	C	163	ASP
4	C	172	THR
4	C	185	VAL
4	C	192	ASN
4	C	199	LEU
4	C	206	ILE
4	C	213	GLU
4	C	226	ASN
4	C	260	ARG
4	C	281	LEU
4	C	301	LEU
4	C	303	GLU
4	C	304	VAL
4	C	312	THR
4	C	322	LEU
4	C	347	LEU

Continued on next page...

Continued from previous page...

Mol	Chain	Res	Type
5	E	524	THR
6	F	177	ARG
2	I	432	LEU
2	I	436	GLU
2	I	503	ARG
2	I	520	GLU
2	I	522	LEU
3	J	145	ASN
3	J	204	ASN
3	J	248	LEU
3	J	268	ARG
3	J	274	LEU
3	J	281	LEU
3	J	284	LEU
3	J	289	LEU
3	J	292	ASP
3	J	343	ASN
3	J	348	LEU
3	J	349	LEU
3	J	388	HIS
3	J	400	VAL
3	J	409	VAL
3	J	412	LEU
3	J	425	GLU
3	J	426	ASP
3	J	427	LEU
3	J	435	PHE
3	J	448	LEU
3	J	461	LYS
3	J	473	LYS
3	J	501	ASN
3	J	509	TRP
3	J	518	GLN
3	J	527	TRP
3	J	555	ARG
3	J	556	LEU
3	J	557	THR
3	J	591	ASP
3	J	593	LEU
3	J	594	ILE
3	J	631	ASP
3	J	633	THR

Continued on next page...

Continued from previous page...

Mol	Chain	Res	Type
3	J	634	THR
3	J	642	LEU
3	J	657	LEU
3	J	660	LEU
3	J	678	ILE
3	J	701	GLU
3	J	729	LEU
3	J	749	GLN
3	J	766	VAL
3	J	800	ILE
3	J	801	ASP
3	J	812	ASP
3	J	879	GLN
3	J	880	PHE
3	J	892	LEU
3	J	938	LEU
3	J	939	LEU
3	J	953	LEU
3	J	956	LEU
3	J	978	LEU
3	J	987	ILE
3	J	996	CYS
3	J	1005	GLN
3	J	1034	ASN
3	J	1042	PHE
3	J	1044	CYS
3	J	1047	LEU
3	J	1101	HIS
3	J	1104	LEU
3	J	1116	GLU
3	J	1129	LYS
4	K	48	THR
4	K	52	LEU
4	K	61	VAL
4	K	63	TRP
4	K	66	ASP
4	K	68	ARG
4	K	69	ARG
4	K	70	LEU
4	K	83	LEU
4	K	89	LEU
4	K	104	GLN

Continued on next page...

Continued from previous page...

Mol	Chain	Res	Type
4	K	113	ASP
4	K	114	LEU
4	K	121	ASP
4	K	124	ILE
4	K	134	CYS
4	K	135	ILE
4	K	152	ASP
4	K	158	VAL
4	K	163	ASP
4	K	172	THR
4	K	185	VAL
4	K	192	ASN
4	K	199	LEU
4	K	206	ILE
4	K	213	GLU
4	K	226	ASN
4	K	260	ARG
4	K	281	LEU
4	K	301	LEU
4	K	303	GLU
4	K	304	VAL
4	K	312	THR
4	K	322	LEU
4	K	347	LEU
6	N	177	ARG
8	P	222	LYS
2	a	51	LEU
2	a	73	LEU
2	a	92	THR
2	a	142	ASP
2	a	152	ASN
2	a	234	LEU
2	a	251	CYS
2	a	271	PHE
2	a	301	PHE
2	a	323	LEU
2	a	325	TYR
2	a	348	GLU
2	a	376	LYS
2	a	379	GLU
2	a	380	HIS
2	a	386	GLU

Continued on next page...

Continued from previous page...

Mol	Chain	Res	Type
2	a	389	ASN
2	a	392	LYS
2	a	432	LEU
2	a	436	GLU
2	a	503	ARG
2	a	520	GLU
2	a	522	LEU
3	b	145	ASN
3	b	160	GLN
3	b	161	LYS
3	b	164	LEU
3	b	165	LEU
3	b	166	ARG
3	b	190	ASP
3	b	223	GLU
3	b	248	LEU
3	b	268	ARG
3	b	274	LEU
3	b	281	LEU
3	b	284	LEU
3	b	289	LEU
3	b	292	ASP
3	b	343	ASN
3	b	348	LEU
3	b	349	LEU
3	b	388	HIS
3	b	400	VAL
3	b	409	VAL
3	b	412	LEU
3	b	425	GLU
3	b	426	ASP
3	b	427	LEU
3	b	435	PHE
3	b	448	LEU
3	b	461	LYS
3	b	473	LYS
3	b	501	ASN
3	b	509	TRP
3	b	518	GLN
3	b	527	TRP
3	b	555	ARG
3	b	556	LEU

Continued on next page...

Continued from previous page...

Mol	Chain	Res	Type
3	b	557	THR
3	b	591	ASP
3	b	593	LEU
3	b	594	ILE
3	b	631	ASP
3	b	633	THR
3	b	634	THR
3	b	642	LEU
3	b	657	LEU
3	b	660	LEU
3	b	678	ILE
3	b	701	GLU
3	b	729	LEU
3	b	749	GLN
3	b	766	VAL
3	b	800	ILE
3	b	801	ASP
3	b	812	ASP
3	b	879	GLN
3	b	880	PHE
3	b	892	LEU
3	b	938	LEU
3	b	939	LEU
3	b	953	LEU
3	b	956	LEU
3	b	978	LEU
3	b	987	ILE
3	b	996	CYS
3	b	1005	GLN
3	b	1034	ASN
3	b	1042	PHE
3	b	1044	CYS
3	b	1047	LEU
3	b	1101	HIS
3	b	1104	LEU
3	b	1116	GLU
3	b	1129	LYS
4	c	48	THR
4	c	52	LEU
4	c	61	VAL
4	c	63	TRP
4	c	66	ASP

Continued on next page...

Continued from previous page...

Mol	Chain	Res	Type
4	c	68	ARG
4	c	69	ARG
4	c	70	LEU
4	c	83	LEU
4	c	89	LEU
4	c	104	GLN
4	c	113	ASP
4	c	114	LEU
4	c	121	ASP
4	c	124	ILE
4	c	134	CYS
4	c	135	ILE
4	c	152	ASP
4	c	158	VAL
4	c	163	ASP
4	c	172	THR
4	c	185	VAL
4	c	192	ASN
4	c	199	LEU
4	c	206	ILE
4	c	213	GLU
4	c	226	ASN
4	c	260	ARG
4	c	281	LEU
4	c	301	LEU
4	c	303	GLU
4	c	304	VAL
4	c	312	THR
4	c	322	LEU
4	c	347	LEU
6	f	177	ARG
2	i	432	LEU
2	i	436	GLU
2	i	503	ARG
2	i	520	GLU
2	i	522	LEU
3	j	145	ASN
3	j	204	ASN
3	j	248	LEU
3	j	268	ARG
3	j	274	LEU
3	j	281	LEU

Continued on next page...

Continued from previous page...

Mol	Chain	Res	Type
3	j	284	LEU
3	j	289	LEU
3	j	292	ASP
3	j	343	ASN
3	j	348	LEU
3	j	349	LEU
3	j	388	HIS
3	j	400	VAL
3	j	409	VAL
3	j	412	LEU
3	j	425	GLU
3	j	426	ASP
3	j	427	LEU
3	j	435	PHE
3	j	448	LEU
3	j	461	LYS
3	j	473	LYS
3	j	501	ASN
3	j	509	TRP
3	j	518	GLN
3	j	527	TRP
3	j	555	ARG
3	j	556	LEU
3	j	557	THR
3	j	591	ASP
3	j	593	LEU
3	j	594	ILE
3	j	631	ASP
3	j	633	THR
3	j	634	THR
3	j	642	LEU
3	j	657	LEU
3	j	660	LEU
3	j	678	ILE
3	j	729	LEU
3	j	749	GLN
3	j	766	VAL
3	j	800	ILE
3	j	801	ASP
3	j	812	ASP
3	j	879	GLN
3	j	880	PHE

Continued on next page...

Continued from previous page...

Mol	Chain	Res	Type
3	j	892	LEU
3	j	938	LEU
3	j	939	LEU
3	j	953	LEU
3	j	956	LEU
3	j	978	LEU
3	j	987	ILE
3	j	996	CYS
3	j	1005	GLN
3	j	1034	ASN
3	j	1042	PHE
3	j	1044	CYS
3	j	1047	LEU
3	j	1101	HIS
3	j	1104	LEU
3	j	1116	GLU
3	j	1129	LYS
4	k	48	THR
4	k	52	LEU
4	k	61	VAL
4	k	63	TRP
4	k	66	ASP
4	k	68	ARG
4	k	69	ARG
4	k	70	LEU
4	k	83	LEU
4	k	89	LEU
4	k	104	GLN
4	k	113	ASP
4	k	114	LEU
4	k	121	ASP
4	k	124	ILE
4	k	134	CYS
4	k	135	ILE
4	k	152	ASP
4	k	158	VAL
4	k	163	ASP
4	k	172	THR
4	k	185	VAL
4	k	192	ASN
4	k	199	LEU
4	k	206	ILE

Continued on next page...

Continued from previous page...

Mol	Chain	Res	Type
4	k	213	GLU
4	k	226	ASN
4	k	260	ARG
4	k	281	LEU
4	k	301	LEU
4	k	303	GLU
4	k	304	VAL
4	k	312	THR
4	k	322	LEU
4	k	347	LEU
6	n	177	ARG
8	p	222	LYS

Sometimes sidechains can be flipped to improve hydrogen bonding and reduce clashes. All (200) such sidechains are listed below:

Mol	Chain	Res	Type
2	A	160	GLN
2	A	242	GLN
2	A	320	HIS
2	A	324	GLN
2	A	512	ASN
2	A	524	ASN
3	B	160	GLN
3	B	204	ASN
3	B	256	GLN
3	B	343	ASN
3	B	360	HIS
3	B	362	GLN
3	B	367	GLN
3	B	388	HIS
3	B	441	HIS
3	B	489	GLN
3	B	526	GLN
3	B	535	HIS
3	B	567	GLN
3	B	573	HIS
3	B	586	GLN
3	B	592	ASN
3	B	608	ASN
3	B	640	GLN
3	B	727	GLN
3	B	749	GLN

Continued on next page...

Continued from previous page...

Mol	Chain	Res	Type
3	B	779	GLN
3	B	787	ASN
3	B	805	ASN
3	B	945	GLN
3	B	1005	GLN
4	C	59	HIS
4	C	104	GLN
4	C	146	ASN
4	C	195	ASN
4	C	203	ASN
4	C	207	ASN
4	C	305	GLN
4	C	316	HIS
5	E	274	GLN
5	E	369	ASN
5	E	465	HIS
5	E	492	GLN
5	E	675	HIS
6	F	130	ASN
6	F	149	GLN
6	F	172	HIS
6	F	261	GLN
8	H	331	GLN
8	H	404	GLN
2	I	141	ASN
2	I	242	GLN
2	I	512	ASN
2	I	524	ASN
3	J	204	ASN
3	J	224	HIS
3	J	256	GLN
3	J	343	ASN
3	J	360	HIS
3	J	362	GLN
3	J	367	GLN
3	J	388	HIS
3	J	441	HIS
3	J	489	GLN
3	J	526	GLN
3	J	535	HIS
3	J	567	GLN
3	J	573	HIS

Continued on next page...

Continued from previous page...

Mol	Chain	Res	Type
3	J	586	GLN
3	J	592	ASN
3	J	608	ASN
3	J	640	GLN
3	J	727	GLN
3	J	749	GLN
3	J	779	GLN
3	J	787	ASN
3	J	805	ASN
3	J	945	GLN
3	J	1005	GLN
4	K	59	HIS
4	K	104	GLN
4	K	146	ASN
4	K	195	ASN
4	K	203	ASN
4	K	207	ASN
4	K	305	GLN
4	K	316	HIS
5	M	369	ASN
5	M	492	GLN
5	M	675	HIS
6	N	149	GLN
6	N	172	HIS
6	N	261	GLN
8	P	67	HIS
8	P	78	GLN
8	P	113	GLN
8	P	128	GLN
8	P	189	HIS
8	P	192	HIS
8	P	331	GLN
8	P	404	GLN
2	a	160	GLN
2	a	242	GLN
2	a	320	HIS
2	a	324	GLN
2	a	512	ASN
2	a	524	ASN
3	b	160	GLN
3	b	204	ASN
3	b	256	GLN

Continued on next page...

Continued from previous page...

Mol	Chain	Res	Type
3	b	343	ASN
3	b	360	HIS
3	b	362	GLN
3	b	367	GLN
3	b	388	HIS
3	b	441	HIS
3	b	489	GLN
3	b	526	GLN
3	b	535	HIS
3	b	567	GLN
3	b	573	HIS
3	b	586	GLN
3	b	592	ASN
3	b	608	ASN
3	b	640	GLN
3	b	727	GLN
3	b	749	GLN
3	b	779	GLN
3	b	787	ASN
3	b	805	ASN
3	b	945	GLN
3	b	1005	GLN
4	c	59	HIS
4	c	104	GLN
4	c	146	ASN
4	c	195	ASN
4	c	203	ASN
4	c	207	ASN
4	c	305	GLN
4	c	316	HIS
5	e	274	GLN
5	e	369	ASN
5	e	492	GLN
5	e	675	HIS
6	f	130	ASN
6	f	172	HIS
6	f	261	GLN
8	h	331	GLN
8	h	404	GLN
2	i	141	ASN
2	i	242	GLN
2	i	512	ASN

Continued on next page...

Continued from previous page...

Mol	Chain	Res	Type
2	i	524	ASN
3	j	204	ASN
3	j	224	HIS
3	j	256	GLN
3	j	343	ASN
3	j	360	HIS
3	j	362	GLN
3	j	367	GLN
3	j	388	HIS
3	j	441	HIS
3	j	489	GLN
3	j	526	GLN
3	j	535	HIS
3	j	567	GLN
3	j	573	HIS
3	j	586	GLN
3	j	592	ASN
3	j	608	ASN
3	j	640	GLN
3	j	727	GLN
3	j	749	GLN
3	j	779	GLN
3	j	787	ASN
3	j	805	ASN
3	j	945	GLN
3	j	1005	GLN
4	k	59	HIS
4	k	104	GLN
4	k	146	ASN
4	k	195	ASN
4	k	203	ASN
4	k	207	ASN
4	k	305	GLN
4	k	316	HIS
5	m	369	ASN
5	m	492	GLN
5	m	675	HIS
6	n	149	GLN
6	n	172	HIS
6	n	261	GLN
8	p	67	HIS
8	p	78	GLN

Continued on next page...

Continued from previous page...

Mol	Chain	Res	Type
8	p	113	GLN
8	p	128	GLN
8	p	189	HIS
8	p	192	HIS
8	p	331	GLN
8	p	404	GLN

5.3.3 RNA [i](#)

Mol	Chain	Analysed	Backbone Outliers	Pucker Outliers
1	2	2/3 (66%)	2 (100%)	0
1	4	2/3 (66%)	2 (100%)	0
All	All	4/6 (66%)	4 (100%)	0

All (4) RNA backbone outliers are listed below:

Mol	Chain	Res	Type
1	2	2	U
1	2	3	U
1	4	2	U
1	4	3	U

There are no RNA pucker outliers to report.

5.4 Non-standard residues in protein, DNA, RNA chains [i](#)

There are no non-standard protein/DNA/RNA residues in this entry.

5.5 Carbohydrates [i](#)

There are no monosaccharides in this entry.

5.6 Ligand geometry [i](#)

There are no ligands in this entry.

5.7 Other polymers [i](#)

There are no such residues in this entry.

5.8 Polymer linkage issues [i](#)

The following chains have linkage breaks:

Mol	Chain	Number of breaks
5	E	1
5	e	1

All chain breaks are listed below:

Model	Chain	Residue-1	Atom-1	Residue-2	Atom-2	Distance (Å)
1	E	86:GLU	C	87:ARG	N	1.11
1	e	86:GLU	C	87:ARG	N	1.11

6 Map visualisation [i](#)

This section contains visualisations of the EMDB entry EMD-14804. These allow visual inspection of the internal detail of the map and identification of artifacts.

No raw map or half-maps were deposited for this entry and therefore no images, graphs, etc. pertaining to the raw map can be shown.

6.1 Orthogonal projections [i](#)

6.1.1 Primary map

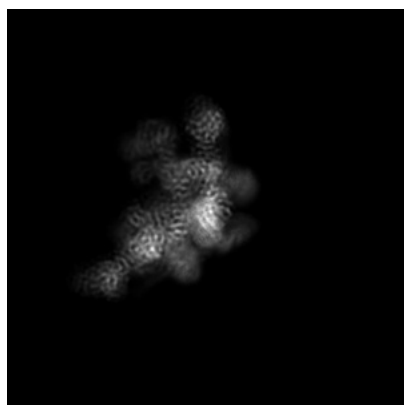

X

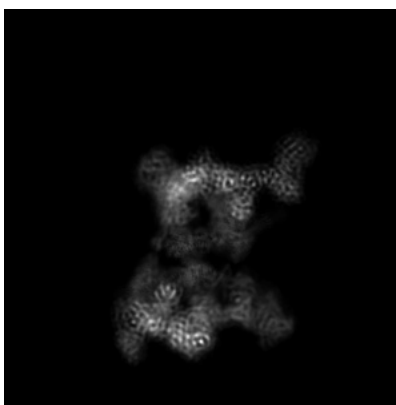

Y

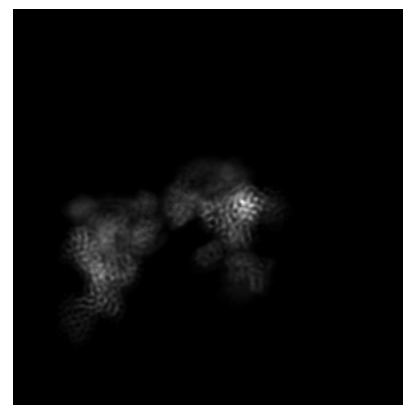

Z

The images above show the map projected in three orthogonal directions.

6.2 Central slices [i](#)

6.2.1 Primary map



X Index: 208



Y Index: 208



Z Index: 208

The images above show central slices of the map in three orthogonal directions.

6.3 Largest variance slices [i](#)

6.3.1 Primary map



X Index: 238



Y Index: 211



Z Index: 205

The images above show the largest variance slices of the map in three orthogonal directions.

6.4 Orthogonal standard-deviation projections (False-color) [i](#)

6.4.1 Primary map

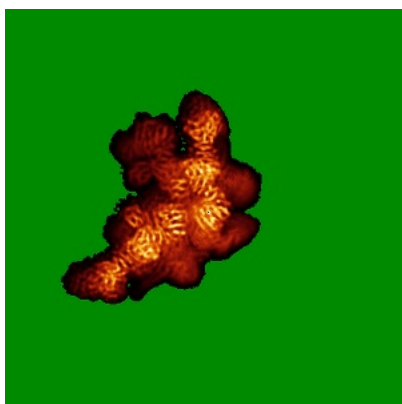

X

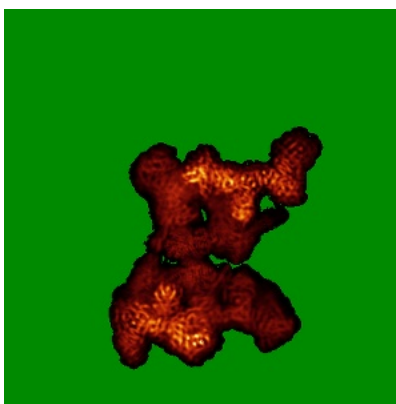

Y

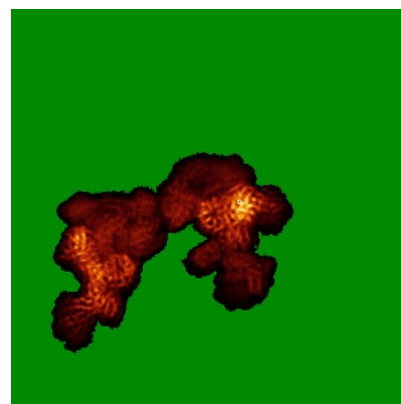

Z

The images above show the map standard deviation projections with false color in three orthogonal directions. Minimum values are shown in green, max in blue, and dark to light orange shades represent small to large values respectively.

6.5 Orthogonal surface views [i](#)

6.5.1 Primary map

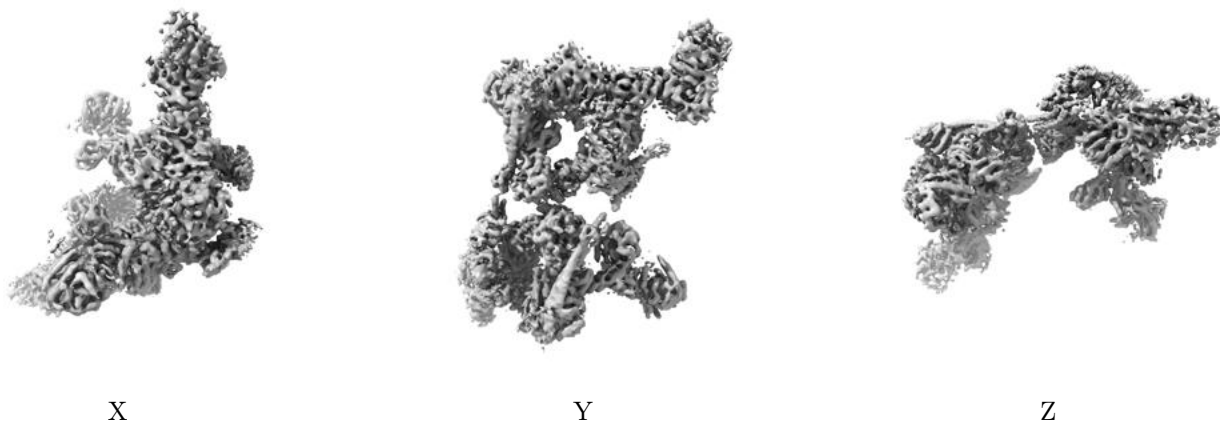

The images above show the 3D surface view of the map at the recommended contour level 1.0. These images, in conjunction with the slice images, may facilitate assessment of whether an appropriate contour level has been provided.

6.6 Mask visualisation [i](#)

This section was not generated. No masks/segmentation were deposited.

7 Map analysis [i](#)

This section contains the results of statistical analysis of the map.

7.1 Map-value distribution [i](#)

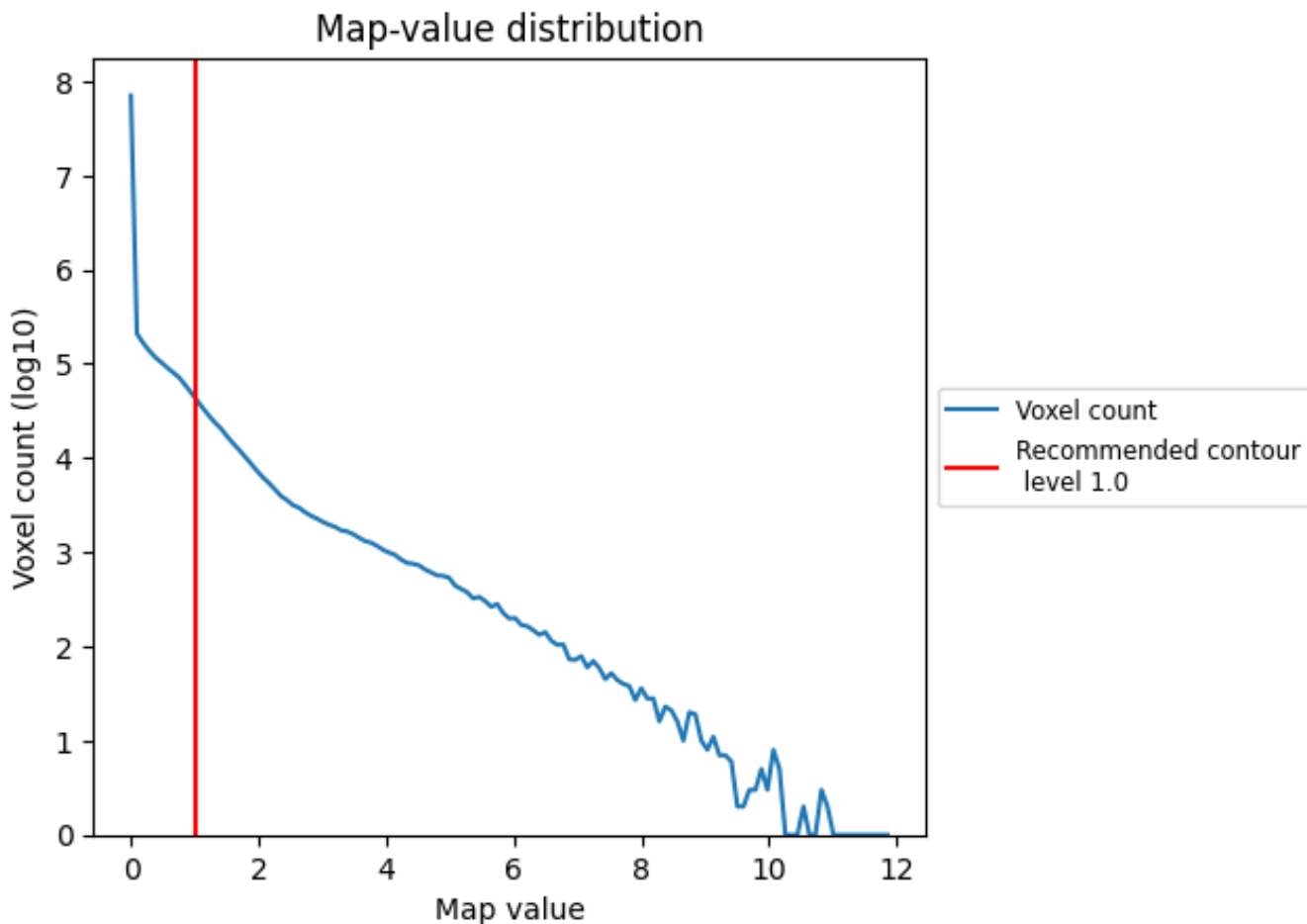

The map-value distribution is plotted in 128 intervals along the x-axis. The y-axis is logarithmic. A spike in this graph at zero usually indicates that the volume has been masked.

7.2 Volume estimate [i](#)

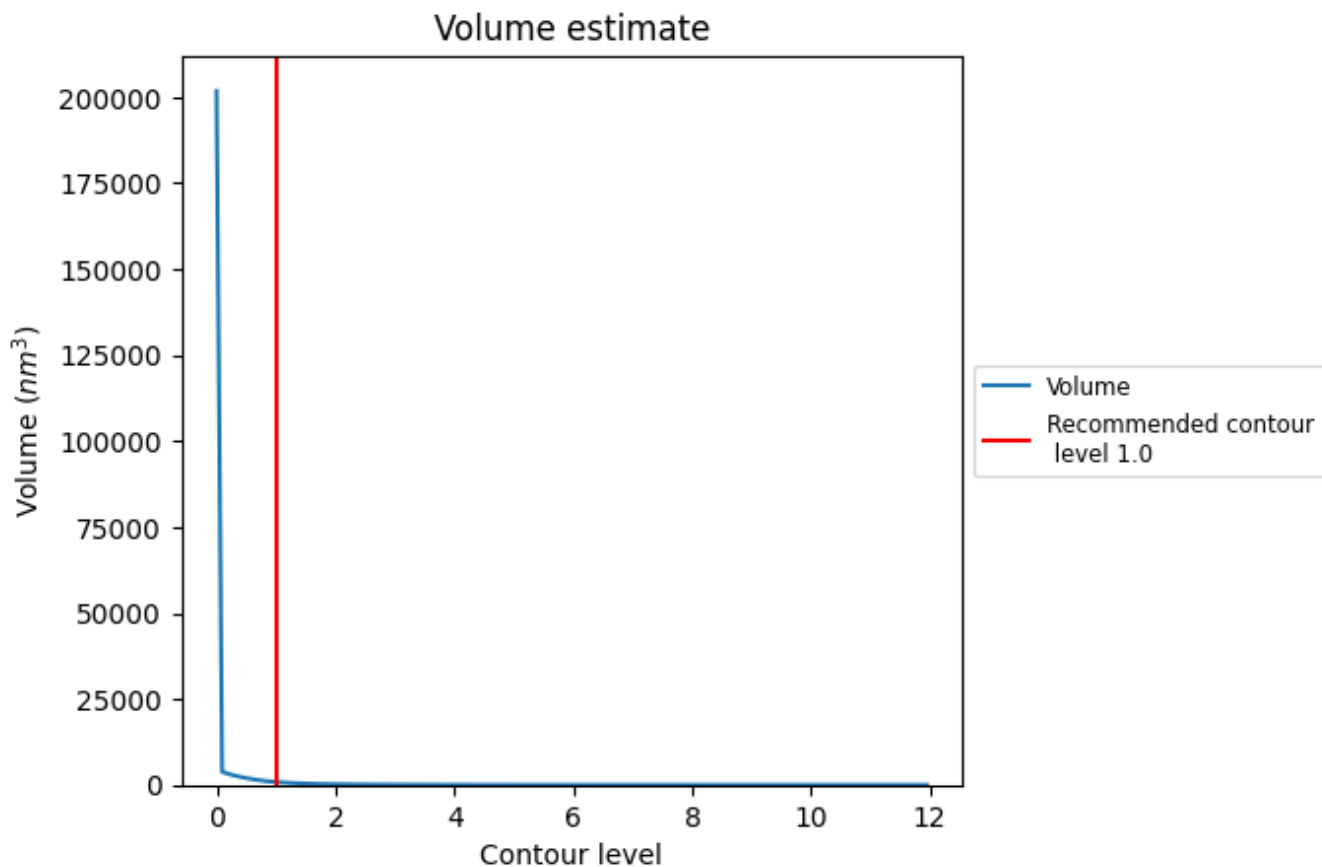

The volume at the recommended contour level is 851 nm³; this corresponds to an approximate mass of 769 kDa.

The volume estimate graph shows how the enclosed volume varies with the contour level. The recommended contour level is shown as a vertical line and the intersection between the line and the curve gives the volume of the enclosed surface at the given level.

7.3 Rotationally averaged power spectrum [i](#)

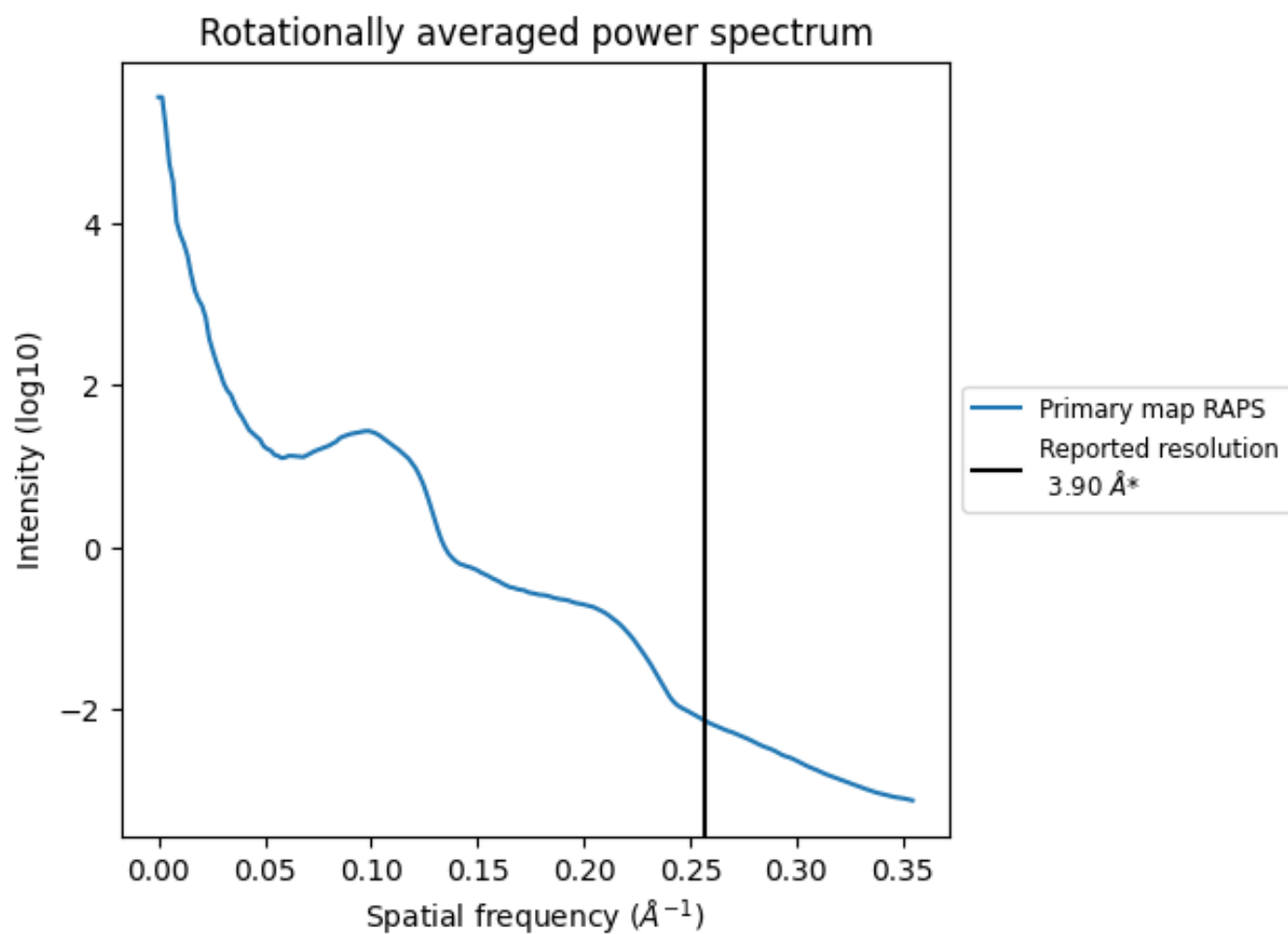

*Reported resolution corresponds to spatial frequency of 0.256 Å⁻¹

8 Fourier-Shell correlation

This section was not generated. No FSC curve or half-maps provided.

9 Map-model fit [i](#)

This section contains information regarding the fit between EMDB map EMD-14804 and PDB model 7ZNK. Per-residue inclusion information can be found in section 3 on page 7.

9.1 Map-model overlay [i](#)

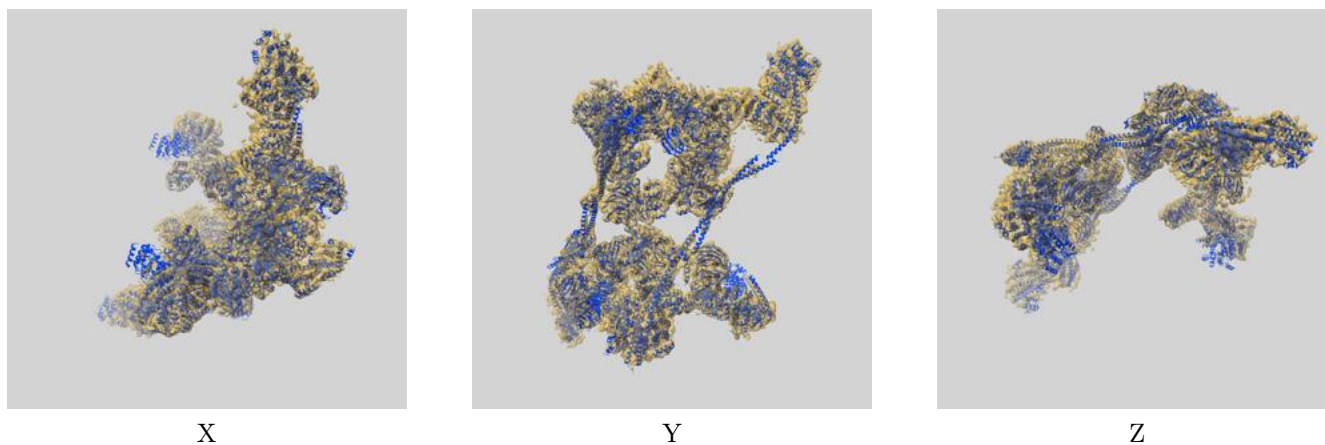

The images above show the 3D surface view of the map at the recommended contour level 1.0 at 50% transparency in yellow overlaid with a ribbon representation of the model coloured in blue. These images allow for the visual assessment of the quality of fit between the atomic model and the map.

9.2 Q-score mapped to coordinate model [i](#)

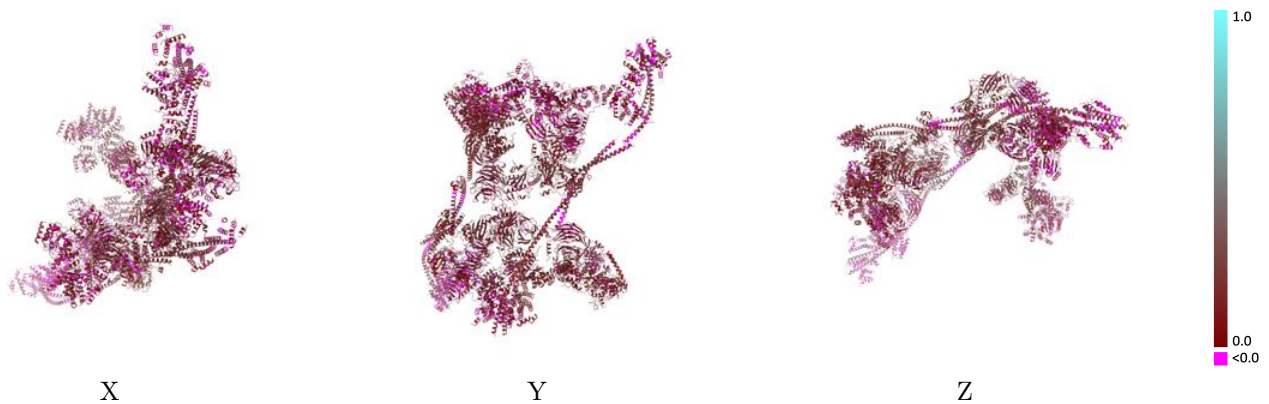

The images above show the model with each residue coloured according to its Q-score. This shows their resolvability in the map with higher Q-score values reflecting better resolvability. Please note: Q-score is calculating the resolvability of atoms, and thus high values are only expected at resolutions at which atoms can be resolved. Low Q-score values may therefore be expected for many entries.

9.3 Atom inclusion mapped to coordinate model [i](#)

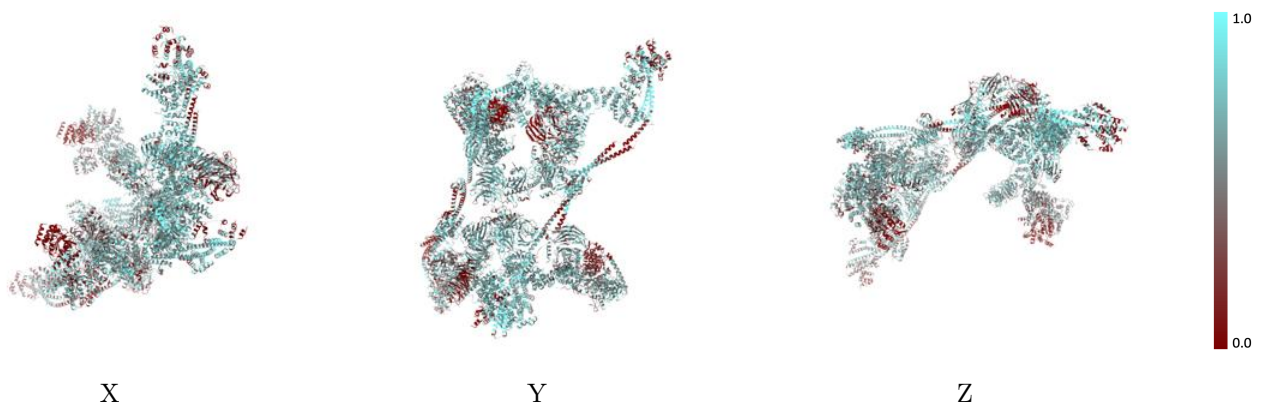

The images above show the model with each residue coloured according to its atom inclusion. This shows to what extent they are inside the map at the recommended contour level (1.0).



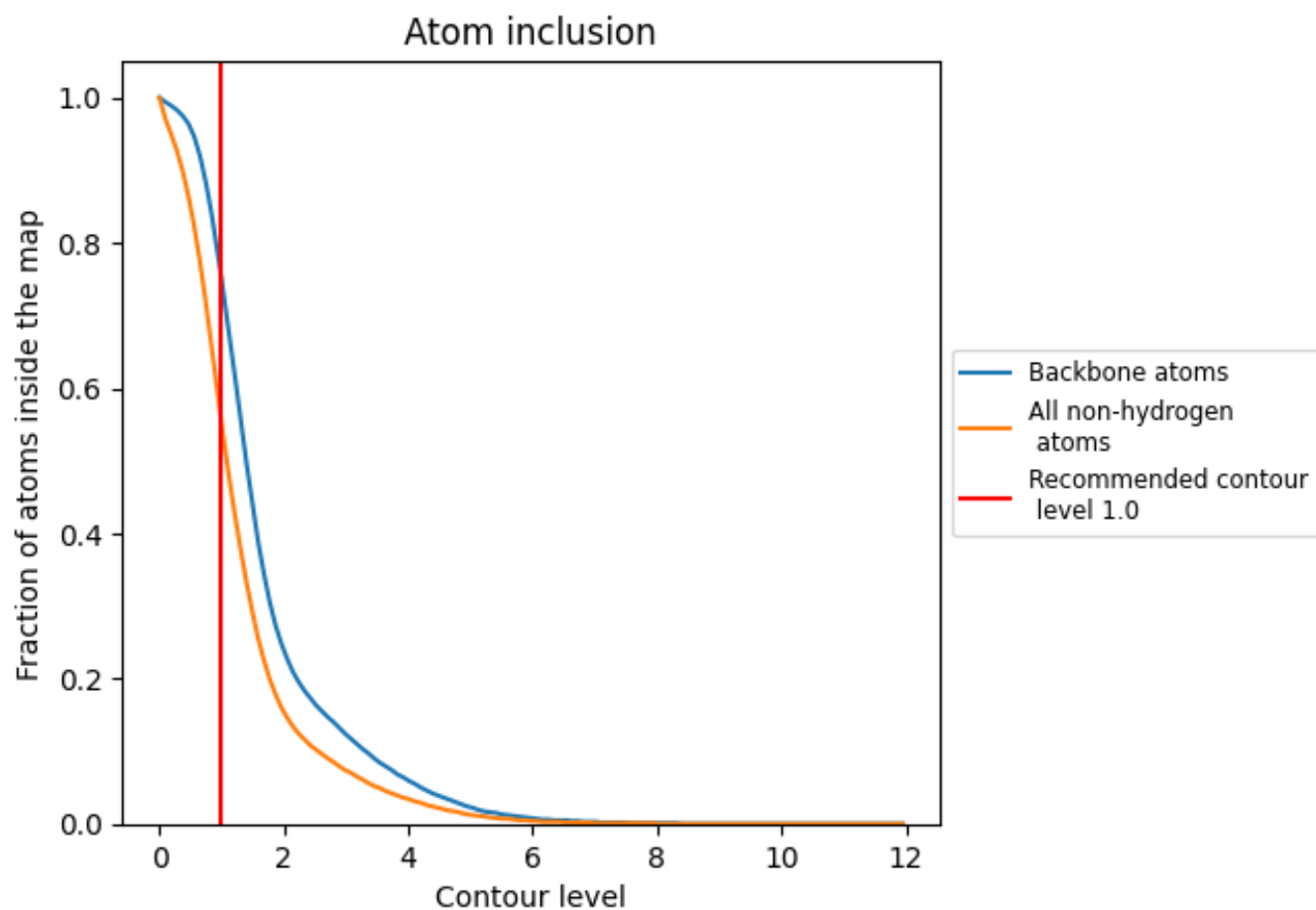































































9.4 Atom inclusion [i](#)



At the recommended contour level, 75% of all backbone atoms, 55% of all non-hydrogen atoms, are inside the map.

9.5 Map-model fit summary

The table lists the average atom inclusion at the recommended contour level (1.0) and Q-score for the entire model and for each chain.

Chain	Atom inclusion	Q-score
All	 0.5510	 0.1390
2	 0.0000	 0.1170
4	 0.0000	 0.1060
A	 0.6300	 0.0940
B	 0.6630	 0.0970
C	 0.7160	 0.0890
E	 0.5820	 0.1990
F	 0.6410	 0.1890
G	 0.5260	 0.1400
H	 0.5800	 0.0650
I	 0.5770	 0.1800
J	 0.5570	 0.1640
K	 0.6040	 0.1680
L	 0.0000	 0.1580
M	 0.5890	 0.1970
N	 0.2390	 0.1190
O	 0.6620	 0.1580
P	 0.1700	 0.1360
a	 0.5910	 0.0700
b	 0.6640	 0.0920
c	 0.7210	 0.0870
e	 0.5510	 0.1750
f	 0.6460	 0.2010
g	 0.4810	 0.1270
h	 0.5980	 0.0750
i	 0.5580	 0.1560
j	 0.5330	 0.1430
k	 0.6170	 0.1690
l	 0.0000	 0.1380
m	 0.5570	 0.1810
n	 0.2150	 0.1160
o	 0.6300	 0.1380
p	 0.1760	 0.1210

