



Full wwPDB X-ray Structure Validation Report ⓘ

Nov 22, 2023 – 11:55 PM JST

PDB ID : 7XSB
Title : Crystal structure of SARS-CoV-2 spike receptor binding domain bound with P5S-3B11 Fab
Authors : Wang, X.; Wang, Z.; Gao, M.
Deposited on : 2022-05-13
Resolution : 3.20 Å (reported)

This is a Full wwPDB X-ray Structure Validation Report for a publicly released PDB entry.

We welcome your comments at validation@mail.wwpdb.org

A user guide is available at

<https://www.wwpdb.org/validation/2017/XrayValidationReportHelp>

with specific help available everywhere you see the ⓘ symbol.

The types of validation reports are described at

<http://www.wwpdb.org/validation/2017/FAQs#types>.

The following versions of software and data (see [references ⓘ](#)) were used in the production of this report:

MolProbity : 4.02b-467
Xtriage (Phenix) : 1.13
EDS : 2.36
Percentile statistics : 20191225.v01 (using entries in the PDB archive December 25th 2019)
Refmac : 5.8.0158
CCP4 : 7.0.044 (Gargrove)
Ideal geometry (proteins) : Engh & Huber (2001)
Ideal geometry (DNA, RNA) : Parkinson et al. (1996)
Validation Pipeline (wwPDB-VP) : 2.36

1 Overall quality at a glance

The following experimental techniques were used to determine the structure:

X-RAY DIFFRACTION

The reported resolution of this entry is 3.20 Å.

Percentile scores (ranging between 0-100) for global validation metrics of the entry are shown in the following graphic. The table shows the number of entries on which the scores are based.

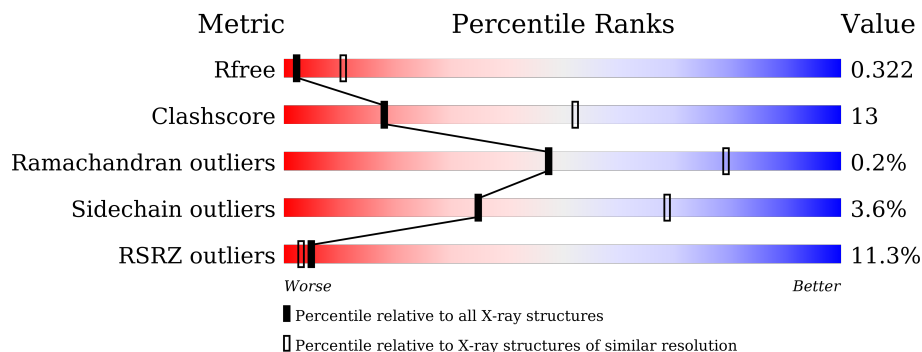

Metric	Whole archive (#Entries)	Similar resolution (#Entries, resolution range(Å))
R_{free}	130704	1133 (3.20-3.20)
Clashscore	141614	1253 (3.20-3.20)
Ramachandran outliers	138981	1234 (3.20-3.20)
Sidechain outliers	138945	1233 (3.20-3.20)
RSRZ outliers	127900	1095 (3.20-3.20)

The table below summarises the geometric issues observed across the polymeric chains and their fit to the electron density. The red, orange, yellow and green segments of the lower bar indicate the fraction of residues that contain outliers for ≥ 3 , 2, 1 and 0 types of geometric quality criteria respectively. A grey segment represents the fraction of residues that are not modelled. The numeric value for each fraction is indicated below the corresponding segment, with a dot representing fractions $\leq 5\%$. The upper red bar (where present) indicates the fraction of residues that have poor fit to the electron density. The numeric value is given above the bar.

Mol	Chain	Length	Quality of chain
1	A	243	
1	B	243	
1	C	243	
1	E	243	
2	D	217	
2	G	217	

Continued on next page...

Continued from previous page...

Mol	Chain	Length	Quality of chain
2	H	217	<p>2% 65% 28% • 6%</p>
2	J	217	<p>31% 65% 24% • 10%</p>
3	F	216	<p>3% 76% 21% ••</p>
3	I	216	<p>36% 75% 21% ••</p>
3	K	216	<p>16% 70% 28% •</p>
3	L	216	<p>2% 73% 23% ••</p>

2 Entry composition i

There are 3 unique types of molecules in this entry. The entry contains 18516 atoms, of which 0 are hydrogens and 0 are deuteriums.

In the tables below, the ZeroOcc column contains the number of atoms modelled with zero occupancy, the AltConf column contains the number of residues with at least one atom in alternate conformation and the Trace column contains the number of residues modelled with at most 2 atoms.

- Molecule 1 is a protein called Spike protein S1.

Mol	Chain	Residues	Atoms					ZeroOcc	AltConf	Trace
			Total	C	N	O	S			
1	E	189	Total 1513	C 972	N 252	O 281	S 8	0	1	0
1	A	188	Total 1505	C 968	N 250	O 279	S 8	0	1	0
1	B	188	Total 1502	C 966	N 250	O 278	S 8	0	1	0
1	C	189	Total 1513	C 972	N 252	O 281	S 8	0	1	0

There are 200 discrepancies between the modelled and reference sequences:

Chain	Residue	Modelled	Actual	Comment	Reference
E	292	MET	-	initiating methionine	UNP P0DTC2
E	293	LEU	-	expression tag	UNP P0DTC2
E	294	LEU	-	expression tag	UNP P0DTC2
E	295	VAL	-	expression tag	UNP P0DTC2
E	296	ASN	-	expression tag	UNP P0DTC2
E	297	GLN	-	expression tag	UNP P0DTC2
E	298	SER	-	expression tag	UNP P0DTC2
E	299	HIS	-	expression tag	UNP P0DTC2
E	300	GLN	-	expression tag	UNP P0DTC2
E	301	GLY	-	expression tag	UNP P0DTC2
E	302	PHE	-	expression tag	UNP P0DTC2
E	303	ASN	-	expression tag	UNP P0DTC2
E	304	LYS	-	expression tag	UNP P0DTC2
E	305	GLU	-	expression tag	UNP P0DTC2
E	306	HIS	-	expression tag	UNP P0DTC2
E	307	THR	-	expression tag	UNP P0DTC2
E	308	SER	-	expression tag	UNP P0DTC2
E	309	LYS	-	expression tag	UNP P0DTC2
E	310	MET	-	expression tag	UNP P0DTC2
E	311	VAL	-	expression tag	UNP P0DTC2
E	312	SER	-	expression tag	UNP P0DTC2

Continued on next page...

Continued from previous page...

Chain	Residue	Modelled	Actual	Comment	Reference
E	313	ALA	-	expression tag	UNP P0DTC2
E	314	ILE	-	expression tag	UNP P0DTC2
E	315	VAL	-	expression tag	UNP P0DTC2
E	316	LEU	-	expression tag	UNP P0DTC2
E	317	TYR	-	expression tag	UNP P0DTC2
E	318	VAL	-	expression tag	UNP P0DTC2
E	319	LEU	-	expression tag	UNP P0DTC2
E	320	LEU	-	expression tag	UNP P0DTC2
E	321	ALA	-	expression tag	UNP P0DTC2
E	322	ALA	-	expression tag	UNP P0DTC2
E	323	ALA	-	expression tag	UNP P0DTC2
E	324	ALA	-	expression tag	UNP P0DTC2
E	325	HIS	-	expression tag	UNP P0DTC2
E	326	SER	-	expression tag	UNP P0DTC2
E	327	ALA	-	expression tag	UNP P0DTC2
E	328	PHE	-	expression tag	UNP P0DTC2
E	329	ALA	-	expression tag	UNP P0DTC2
E	330	ALA	-	expression tag	UNP P0DTC2
E	331	ASP	-	expression tag	UNP P0DTC2
E	332	PRO	-	expression tag	UNP P0DTC2
E	417	ASN	LYS	variant	UNP P0DTC2
E	484	LYS	GLU	variant	UNP P0DTC2
E	501	TYR	ASN	variant	UNP P0DTC2
E	529	HIS	-	expression tag	UNP P0DTC2
E	530	HIS	-	expression tag	UNP P0DTC2
E	531	HIS	-	expression tag	UNP P0DTC2
E	532	HIS	-	expression tag	UNP P0DTC2
E	533	HIS	-	expression tag	UNP P0DTC2
E	534	HIS	-	expression tag	UNP P0DTC2
A	292	MET	-	initiating methionine	UNP P0DTC2
A	293	LEU	-	expression tag	UNP P0DTC2
A	294	LEU	-	expression tag	UNP P0DTC2
A	295	VAL	-	expression tag	UNP P0DTC2
A	296	ASN	-	expression tag	UNP P0DTC2
A	297	GLN	-	expression tag	UNP P0DTC2
A	298	SER	-	expression tag	UNP P0DTC2
A	299	HIS	-	expression tag	UNP P0DTC2
A	300	GLN	-	expression tag	UNP P0DTC2
A	301	GLY	-	expression tag	UNP P0DTC2
A	302	PHE	-	expression tag	UNP P0DTC2
A	303	ASN	-	expression tag	UNP P0DTC2
A	304	LYS	-	expression tag	UNP P0DTC2

Continued on next page...

Continued from previous page...

Chain	Residue	Modelled	Actual	Comment	Reference
A	305	GLU	-	expression tag	UNP P0DTC2
A	306	HIS	-	expression tag	UNP P0DTC2
A	307	THR	-	expression tag	UNP P0DTC2
A	308	SER	-	expression tag	UNP P0DTC2
A	309	LYS	-	expression tag	UNP P0DTC2
A	310	MET	-	expression tag	UNP P0DTC2
A	311	VAL	-	expression tag	UNP P0DTC2
A	312	SER	-	expression tag	UNP P0DTC2
A	313	ALA	-	expression tag	UNP P0DTC2
A	314	ILE	-	expression tag	UNP P0DTC2
A	315	VAL	-	expression tag	UNP P0DTC2
A	316	LEU	-	expression tag	UNP P0DTC2
A	317	TYR	-	expression tag	UNP P0DTC2
A	318	VAL	-	expression tag	UNP P0DTC2
A	319	LEU	-	expression tag	UNP P0DTC2
A	320	LEU	-	expression tag	UNP P0DTC2
A	321	ALA	-	expression tag	UNP P0DTC2
A	322	ALA	-	expression tag	UNP P0DTC2
A	323	ALA	-	expression tag	UNP P0DTC2
A	324	ALA	-	expression tag	UNP P0DTC2
A	325	HIS	-	expression tag	UNP P0DTC2
A	326	SER	-	expression tag	UNP P0DTC2
A	327	ALA	-	expression tag	UNP P0DTC2
A	328	PHE	-	expression tag	UNP P0DTC2
A	329	ALA	-	expression tag	UNP P0DTC2
A	330	ALA	-	expression tag	UNP P0DTC2
A	331	ASP	-	expression tag	UNP P0DTC2
A	332	PRO	-	expression tag	UNP P0DTC2
A	417	ASN	LYS	variant	UNP P0DTC2
A	484	LYS	GLU	variant	UNP P0DTC2
A	501	TYR	ASN	variant	UNP P0DTC2
A	529	HIS	-	expression tag	UNP P0DTC2
A	530	HIS	-	expression tag	UNP P0DTC2
A	531	HIS	-	expression tag	UNP P0DTC2
A	532	HIS	-	expression tag	UNP P0DTC2
A	533	HIS	-	expression tag	UNP P0DTC2
A	534	HIS	-	expression tag	UNP P0DTC2
B	292	MET	-	initiating methionine	UNP P0DTC2
B	293	LEU	-	expression tag	UNP P0DTC2
B	294	LEU	-	expression tag	UNP P0DTC2
B	295	VAL	-	expression tag	UNP P0DTC2
B	296	ASN	-	expression tag	UNP P0DTC2

Continued on next page...

Continued from previous page...

Chain	Residue	Modelled	Actual	Comment	Reference
B	297	GLN	-	expression tag	UNP P0DTC2
B	298	SER	-	expression tag	UNP P0DTC2
B	299	HIS	-	expression tag	UNP P0DTC2
B	300	GLN	-	expression tag	UNP P0DTC2
B	301	GLY	-	expression tag	UNP P0DTC2
B	302	PHE	-	expression tag	UNP P0DTC2
B	303	ASN	-	expression tag	UNP P0DTC2
B	304	LYS	-	expression tag	UNP P0DTC2
B	305	GLU	-	expression tag	UNP P0DTC2
B	306	HIS	-	expression tag	UNP P0DTC2
B	307	THR	-	expression tag	UNP P0DTC2
B	308	SER	-	expression tag	UNP P0DTC2
B	309	LYS	-	expression tag	UNP P0DTC2
B	310	MET	-	expression tag	UNP P0DTC2
B	311	VAL	-	expression tag	UNP P0DTC2
B	312	SER	-	expression tag	UNP P0DTC2
B	313	ALA	-	expression tag	UNP P0DTC2
B	314	ILE	-	expression tag	UNP P0DTC2
B	315	VAL	-	expression tag	UNP P0DTC2
B	316	LEU	-	expression tag	UNP P0DTC2
B	317	TYR	-	expression tag	UNP P0DTC2
B	318	VAL	-	expression tag	UNP P0DTC2
B	319	LEU	-	expression tag	UNP P0DTC2
B	320	LEU	-	expression tag	UNP P0DTC2
B	321	ALA	-	expression tag	UNP P0DTC2
B	322	ALA	-	expression tag	UNP P0DTC2
B	323	ALA	-	expression tag	UNP P0DTC2
B	324	ALA	-	expression tag	UNP P0DTC2
B	325	HIS	-	expression tag	UNP P0DTC2
B	326	SER	-	expression tag	UNP P0DTC2
B	327	ALA	-	expression tag	UNP P0DTC2
B	328	PHE	-	expression tag	UNP P0DTC2
B	329	ALA	-	expression tag	UNP P0DTC2
B	330	ALA	-	expression tag	UNP P0DTC2
B	331	ASP	-	expression tag	UNP P0DTC2
B	332	PRO	-	expression tag	UNP P0DTC2
B	417	ASN	LYS	variant	UNP P0DTC2
B	484	LYS	GLU	variant	UNP P0DTC2
B	501	TYR	ASN	variant	UNP P0DTC2
B	529	HIS	-	expression tag	UNP P0DTC2
B	530	HIS	-	expression tag	UNP P0DTC2
B	531	HIS	-	expression tag	UNP P0DTC2

Continued on next page...

Continued from previous page...

Chain	Residue	Modelled	Actual	Comment	Reference
B	532	HIS	-	expression tag	UNP P0DTC2
B	533	HIS	-	expression tag	UNP P0DTC2
B	534	HIS	-	expression tag	UNP P0DTC2
C	292	MET	-	initiating methionine	UNP P0DTC2
C	293	LEU	-	expression tag	UNP P0DTC2
C	294	LEU	-	expression tag	UNP P0DTC2
C	295	VAL	-	expression tag	UNP P0DTC2
C	296	ASN	-	expression tag	UNP P0DTC2
C	297	GLN	-	expression tag	UNP P0DTC2
C	298	SER	-	expression tag	UNP P0DTC2
C	299	HIS	-	expression tag	UNP P0DTC2
C	300	GLN	-	expression tag	UNP P0DTC2
C	301	GLY	-	expression tag	UNP P0DTC2
C	302	PHE	-	expression tag	UNP P0DTC2
C	303	ASN	-	expression tag	UNP P0DTC2
C	304	LYS	-	expression tag	UNP P0DTC2
C	305	GLU	-	expression tag	UNP P0DTC2
C	306	HIS	-	expression tag	UNP P0DTC2
C	307	THR	-	expression tag	UNP P0DTC2
C	308	SER	-	expression tag	UNP P0DTC2
C	309	LYS	-	expression tag	UNP P0DTC2
C	310	MET	-	expression tag	UNP P0DTC2
C	311	VAL	-	expression tag	UNP P0DTC2
C	312	SER	-	expression tag	UNP P0DTC2
C	313	ALA	-	expression tag	UNP P0DTC2
C	314	ILE	-	expression tag	UNP P0DTC2
C	315	VAL	-	expression tag	UNP P0DTC2
C	316	LEU	-	expression tag	UNP P0DTC2
C	317	TYR	-	expression tag	UNP P0DTC2
C	318	VAL	-	expression tag	UNP P0DTC2
C	319	LEU	-	expression tag	UNP P0DTC2
C	320	LEU	-	expression tag	UNP P0DTC2
C	321	ALA	-	expression tag	UNP P0DTC2
C	322	ALA	-	expression tag	UNP P0DTC2
C	323	ALA	-	expression tag	UNP P0DTC2
C	324	ALA	-	expression tag	UNP P0DTC2
C	325	HIS	-	expression tag	UNP P0DTC2
C	326	SER	-	expression tag	UNP P0DTC2
C	327	ALA	-	expression tag	UNP P0DTC2
C	328	PHE	-	expression tag	UNP P0DTC2
C	329	ALA	-	expression tag	UNP P0DTC2
C	330	ALA	-	expression tag	UNP P0DTC2

Continued on next page...

Continued from previous page...

Chain	Residue	Modelled	Actual	Comment	Reference
C	331	ASP	-	expression tag	UNP P0DTC2
C	332	PRO	-	expression tag	UNP P0DTC2
C	417	ASN	LYS	variant	UNP P0DTC2
C	484	LYS	GLU	variant	UNP P0DTC2
C	501	TYR	ASN	variant	UNP P0DTC2
C	529	HIS	-	expression tag	UNP P0DTC2
C	530	HIS	-	expression tag	UNP P0DTC2
C	531	HIS	-	expression tag	UNP P0DTC2
C	532	HIS	-	expression tag	UNP P0DTC2
C	533	HIS	-	expression tag	UNP P0DTC2
C	534	HIS	-	expression tag	UNP P0DTC2

- Molecule 2 is a protein called P5S-3B11 Heavy chain.

Mol	Chain	Residues	Atoms					ZeroOcc	AltConf	Trace
			Total	C	N	O	S			
2	H	203	1552	987	266	293	6	0	0	0
2	D	203	1552	987	266	293	6	0	0	0
2	G	198	1505	959	259	281	6	0	0	0
2	J	196	1508	961	258	283	6	0	0	0

- Molecule 3 is a protein called P5S-3B11 Light chain.

Mol	Chain	Residues	Atoms					ZeroOcc	AltConf	Trace
			Total	C	N	O	S			
3	L	212	1592	995	262	330	5	0	0	0
3	F	212	1594	998	262	329	5	0	0	0
3	I	212	1594	998	262	329	5	0	0	0
3	K	212	1586	995	261	325	5	0	0	0

3 Residue-property plots

These plots are drawn for all protein, RNA, DNA and oligosaccharide chains in the entry. The first graphic for a chain summarises the proportions of the various outlier classes displayed in the second graphic. The second graphic shows the sequence view annotated by issues in geometry and electron density. Residues are color-coded according to the number of geometric quality criteria for which they contain at least one outlier: green = 0, yellow = 1, orange = 2 and red = 3 or more. A red dot above a residue indicates a poor fit to the electron density ($RSRZ > 2$). Stretches of 2 or more consecutive residues without any outlier are shown as a green connector. Residues present in the sample, but not in the model, are shown in grey.

- Molecule 1: Spike protein S1

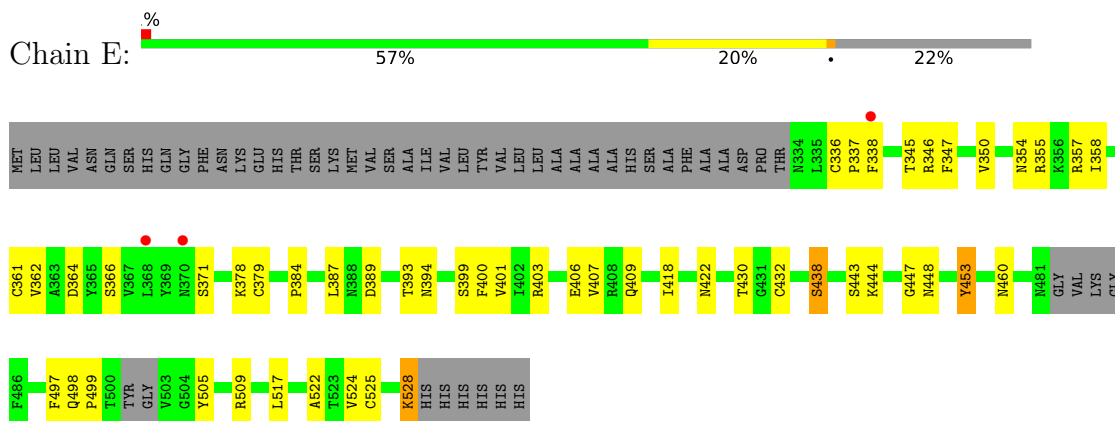

- Molecule 1: Spike protein S1

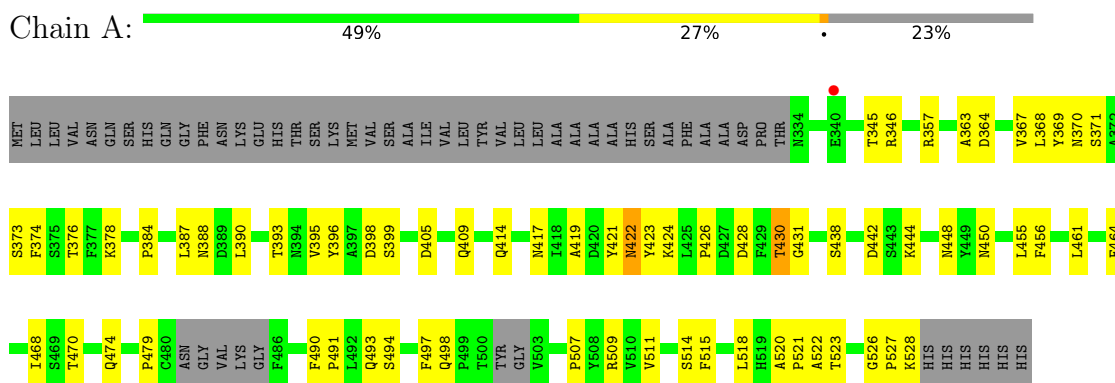

- Molecule 1: Spike protein S1

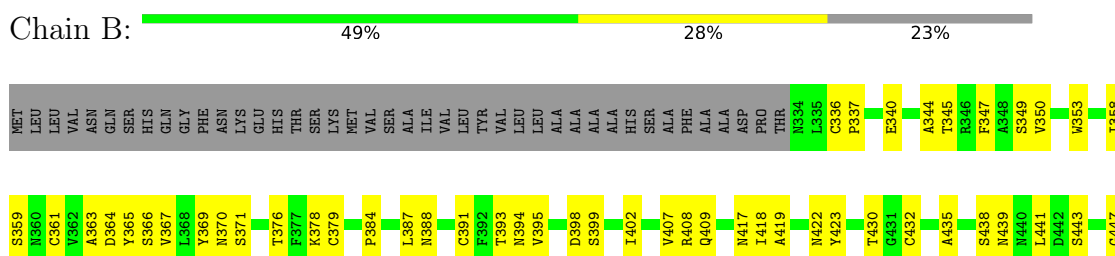



- Molecule 1: Spike protein S1

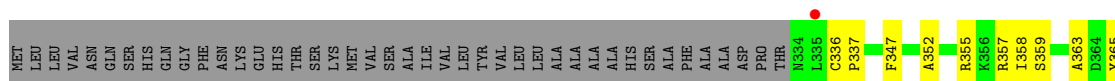

- Molecule 2: P5S-3B11 Heavy chain

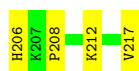

- Molecule 2: P5S-3B11 Heavy chain

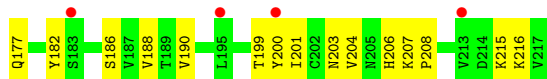
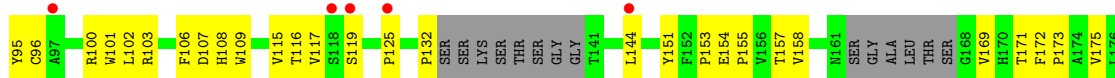
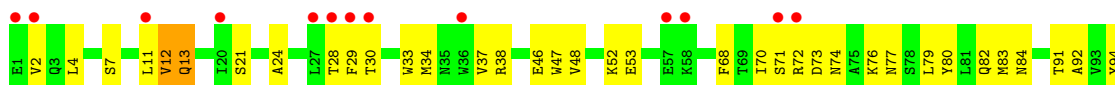

- Molecule 2: P5S-3B11 Heavy chain



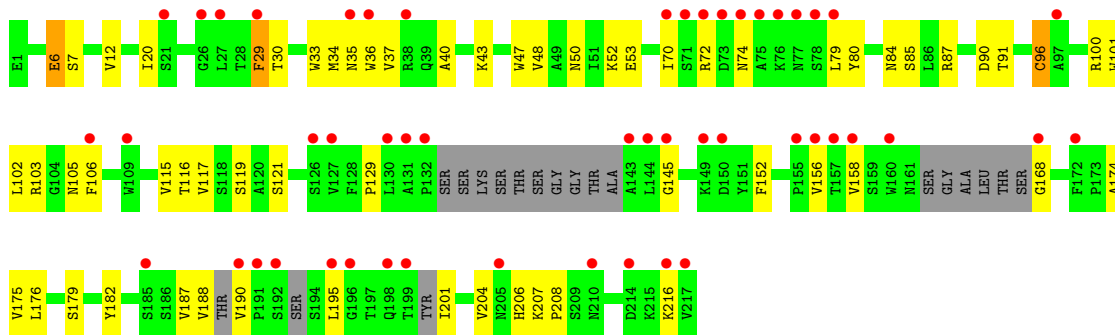

- Molecule 2: P5S-3B11 Heavy chain

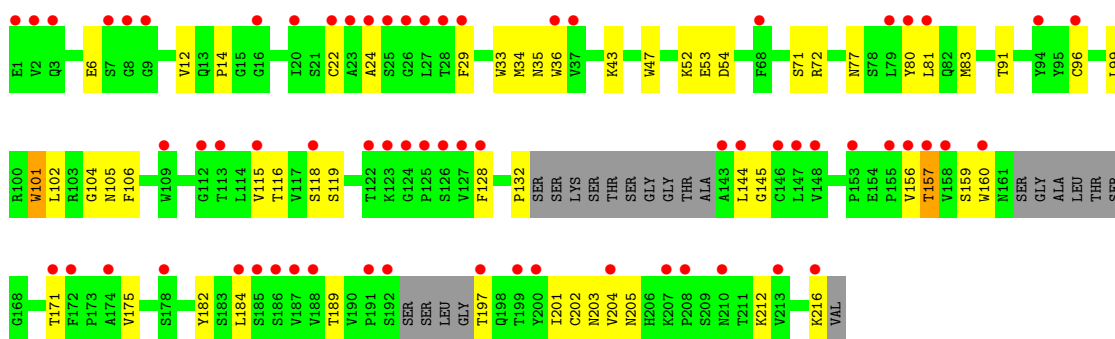

- Molecule 3: P5S-3B11 Light chain

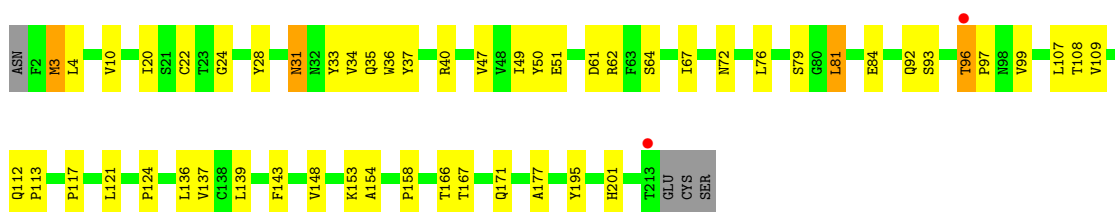
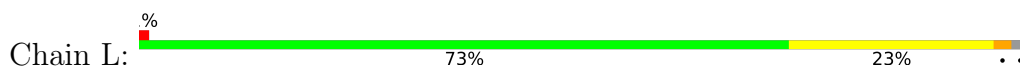

- Molecule 3: P5S-3B11 Light chain

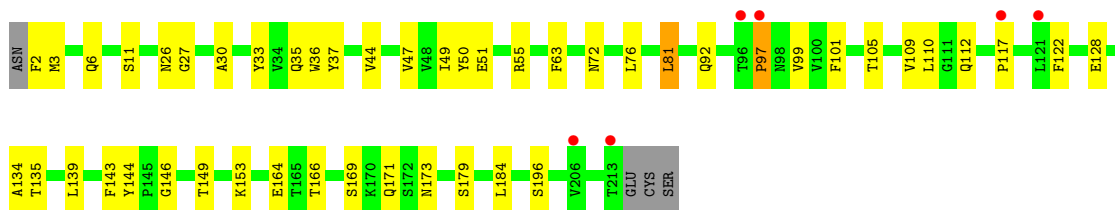
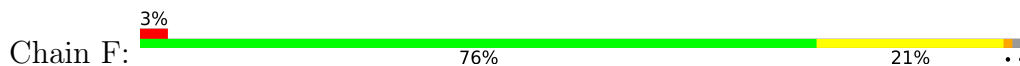

- Molecule 3: P5S-3B11 Light chain

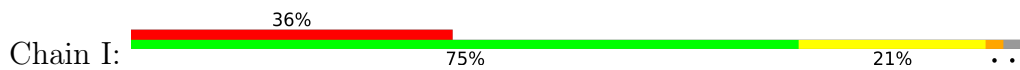

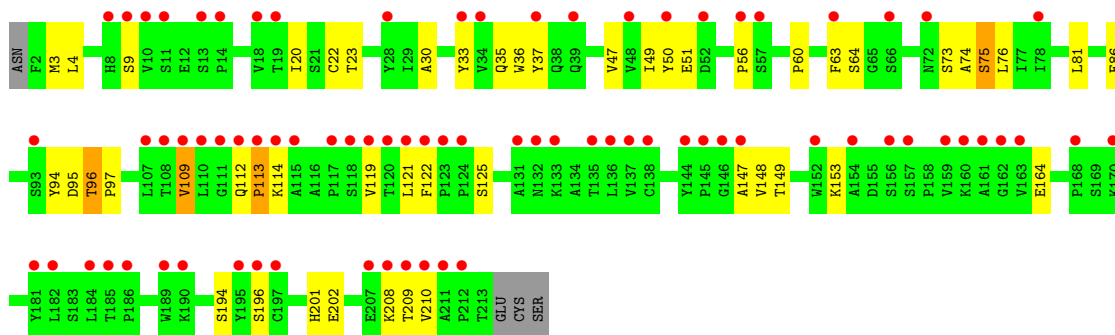

- Molecule 3: P5S-3B11 Light chain

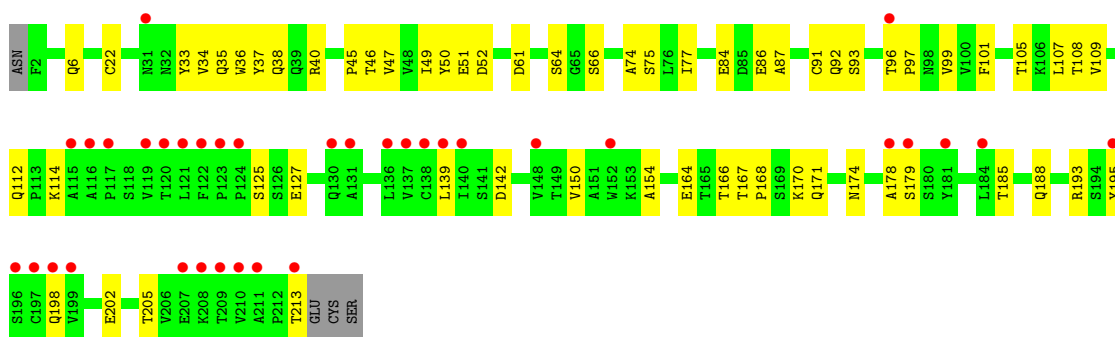

4 Data and refinement statistics i

Property	Value	Source
Space group	P 1 21 1	Depositor
Cell constants a, b, c, α , β , γ	127.77Å 85.73Å 136.62Å 90.00° 90.39° 90.00°	Depositor
Resolution (Å)	46.82 – 3.20 49.38 – 3.20	Depositor EDS
% Data completeness (in resolution range)	98.0 (46.82-3.20) 98.2 (49.38-3.20)	Depositor EDS
R_{merge}	0.17	Depositor
R_{sym}	(Not available)	Depositor
$\langle I/\sigma(I) \rangle$ ¹	1.48 (at 3.19Å)	Xtrriage
Refinement program	PHENIX (1.18.2_3874: ???)	Depositor
R, R_{free}	0.258 , 0.324 0.259 , 0.322	Depositor DCC
R_{free} test set	2378 reflections (4.94%)	wwPDB-VP
Wilson B-factor (Å ²)	75.2	Xtrriage
Anisotropy	0.383	Xtrriage
Bulk solvent k_{sol} (e/Å ³), B_{sol} (Å ²)	0.30 , 107.0	EDS
L-test for twinning ²	$\langle L \rangle = 0.46$, $\langle L^2 \rangle = 0.29$	Xtrriage
Estimated twinning fraction	0.034 for h,-k,-l	Xtrriage
F_o, F_c correlation	0.87	EDS
Total number of atoms	18516	wwPDB-VP
Average B, all atoms (Å ²)	117.0	wwPDB-VP

Xtrriage's analysis on translational NCS is as follows: *The largest off-origin peak in the Patterson function is 7.81% of the height of the origin peak. No significant pseudotranslation is detected.*

¹Intensities estimated from amplitudes.

²Theoretical values of $\langle |L| \rangle$, $\langle L^2 \rangle$ for acentric reflections are 0.5, 0.333 respectively for untwinned datasets, and 0.375, 0.2 for perfectly twinned datasets.

5 Model quality [i](#)

5.1 Standard geometry [i](#)

The Z score for a bond length (or angle) is the number of standard deviations the observed value is removed from the expected value. A bond length (or angle) with $|Z| > 5$ is considered an outlier worth inspection. RMSZ is the root-mean-square of all Z scores of the bond lengths (or angles).

Mol	Chain	Bond lengths		Bond angles	
		RMSZ	# Z >5	RMSZ	# Z >5
1	A	0.60	0/1550	0.73	0/2108
1	B	0.62	0/1547	0.77	0/2103
1	C	0.62	0/1558	0.78	0/2119
1	E	0.64	0/1558	0.76	0/2119
2	D	0.48	0/1589	0.70	0/2162
2	G	0.40	0/1538	0.64	0/2087
2	H	0.46	0/1589	0.70	0/2162
2	J	0.39	0/1544	0.58	0/2098
3	F	0.44	0/1634	0.64	1/2236 (0.0%)
3	I	0.40	0/1634	0.63	0/2236
3	K	0.41	0/1626	0.64	0/2225
3	L	0.50	0/1632	0.69	0/2235
All	All	0.50	0/18999	0.69	1/25890 (0.0%)

There are no bond length outliers.

All (1) bond angle outliers are listed below:

Mol	Chain	Res	Type	Atoms	Z	Observed(°)	Ideal(°)
3	F	97	PRO	N-CA-CB	-5.35	96.72	102.60

There are no chirality outliers.

There are no planarity outliers.

5.2 Too-close contacts [i](#)

In the following table, the Non-H and H(model) columns list the number of non-hydrogen atoms and hydrogen atoms in the chain respectively. The H(added) column lists the number of hydrogen atoms added and optimized by MolProbity. The Clashes column lists the number of clashes within the asymmetric unit, whereas Symm-Clashes lists symmetry-related clashes.

Mol	Chain	Non-H	H(model)	H(added)	Clashes	Symm-Clashes
1	A	1505	0	1427	48	0
1	B	1502	0	1423	42	0
1	C	1513	0	1433	53	0
1	E	1513	0	1433	32	0
2	D	1552	0	1526	60	0
2	G	1505	0	1470	56	0
2	H	1552	0	1526	54	0
2	J	1508	0	1478	46	0
3	F	1594	0	1523	41	0
3	I	1594	0	1523	41	0
3	K	1586	0	1512	47	0
3	L	1592	0	1514	39	0
All	All	18516	0	17788	489	0

The all-atom clashscore is defined as the number of clashes found per 1000 atoms (including hydrogen atoms). The all-atom clashscore for this structure is 13.

All (489) close contacts within the same asymmetric unit are listed below, sorted by their clash magnitude.

Atom-1	Atom-2	Interatomic distance (Å)	Clash overlap (Å)
2:H:33:TRP:HB2	2:H:99:LEU:HD11	1.30	1.09
2:J:14:PRO:HD2	2:J:119:SER:HB3	1.51	0.89
1:A:369:TYR:HE2	2:G:101:TRP:HB2	1.37	0.87
3:I:96:THR:HG23	3:I:97:PRO:HD3	1.58	0.85
2:G:207:LYS:HG3	2:G:208:PRO:HD3	1.58	0.85
2:H:101:TRP:HZ2	3:L:51:GLU:HG2	1.39	0.85
2:J:201:ILE:HG12	2:J:216:LYS:HG2	1.59	0.84
2:H:33:TRP:HB2	2:H:99:LEU:CD1	2.08	0.83
1:A:444:LYS:HG3	1:A:448:ASN:HB2	1.61	0.82
3:K:96:THR:HB	3:K:97:PRO:HD3	1.61	0.82
2:J:157:THR:HG23	2:J:205:ASN:HB3	1.66	0.78
1:E:403:ARG:HG2	1:E:505:TYR:HA	1.67	0.77
2:J:132:PRO:HD3	2:J:144:LEU:HB3	1.66	0.76
1:A:369:TYR:CE2	2:G:101:TRP:HB2	2.19	0.76
2:J:91:THR:HG23	2:J:116:THR:HA	1.66	0.75
1:E:418:ILE:HA	1:E:422:ASN:HB2	1.69	0.75
2:J:101:TRP:HZ2	3:K:51:GLU:HG2	1.52	0.75
1:C:369:TYR:CZ	2:J:101:TRP:CE3	2.75	0.74
2:J:47:TRP:CD1	3:K:99:VAL:HB	2.22	0.74
1:B:417:ASN:ND2	3:K:61:ASP:OD2	2.21	0.73
2:D:132:PRO:HD3	2:D:144:LEU:HB3	1.68	0.73
2:G:30:THR:HG22	2:G:74:ASN:HB3	1.69	0.73

Continued on next page...

Continued from previous page...

Atom-1	Atom-2	Interatomic distance (Å)	Clash overlap (Å)
3:F:37:TYR:HE1	3:F:47:VAL:HG22	1.53	0.73
2:D:95:TYR:HE1	3:F:44:VAL:HG22	1.53	0.72
2:G:190:VAL:HG23	2:G:195:LEU:HD12	1.72	0.71
2:J:101:TRP:N	2:J:101:TRP:CD1	2.57	0.71
3:K:170:LYS:NZ	3:K:174:ASN:O	2.23	0.71
2:G:35:ASN:HD22	2:G:47:TRP:HE1	1.38	0.71
1:C:369:TYR:CE2	2:J:101:TRP:HB2	2.26	0.70
3:K:40:ARG:NH2	3:K:84:GLU:O	2.24	0.70
2:H:40:ALA:HB3	2:H:43:LYS:HD2	1.73	0.70
2:J:101:TRP:NE1	2:J:104:GLY:HA3	2.06	0.70
2:J:101:TRP:CZ2	3:K:51:GLU:HG2	2.26	0.69
1:E:438:SER:OG	1:E:509:ARG:HG3	1.92	0.69
1:C:391:CYS:SG	1:C:528:LYS:HE2	2.32	0.69
2:H:99:LEU:HB3	2:H:106:PHE:CE1	2.27	0.68
1:E:384:PRO:HG2	2:H:101:TRP:CZ3	2.29	0.68
1:E:460:ASN:OD1	1:C:460:ASN:ND2	2.27	0.68
2:D:158:VAL:HG22	2:D:204:VAL:HG22	1.76	0.68
2:D:47:TRP:HB2	3:F:101:PHE:HE2	1.59	0.67
2:J:159:SER:O	2:J:203:ASN:N	2.26	0.67
1:B:376:THR:HB	1:B:435:ALA:HB3	1.76	0.67
2:D:91:THR:HG23	2:D:116:THR:HA	1.75	0.67
1:A:438:SER:HB3	1:A:509:ARG:HG3	1.77	0.67
1:B:438:SER:HB3	1:B:509:ARG:HG3	1.76	0.66
2:G:6:GLU:OE2	2:G:96:CYS:N	2.26	0.66
2:D:12:VAL:HG23	2:D:117:VAL:HG22	1.78	0.66
2:H:29:PHE:HZ	2:H:79:LEU:HB2	1.60	0.66
3:F:36:TRP:HB2	3:F:49:ILE:HB	1.78	0.66
3:L:96:THR:HG23	3:L:97:PRO:HD3	1.77	0.66
2:H:33:TRP:CB	2:H:99:LEU:HD11	2.17	0.65
1:A:493:GLN:OE1	1:A:494:SER:N	2.25	0.65
2:J:29:PHE:CZ	2:J:34:MET:HG3	2.31	0.65
3:L:4:LEU:HD13	3:L:22:CYS:SG	2.37	0.65
1:A:378:LYS:HG3	3:I:33:TYR:CZ	2.32	0.65
1:B:369:TYR:CZ	1:B:384:PRO:HB2	2.31	0.65
2:D:34:MET:HB3	2:D:79:LEU:HD13	1.78	0.65
1:C:440:ASN:OD1	1:C:440:ASN:N	2.22	0.65
3:L:37:TYR:HE2	3:L:92:GLN:HG2	1.62	0.65
3:K:142:ASP:OD1	3:K:171:GLN:NE2	2.30	0.65
2:D:82:GLN:NE2	2:D:84:ASN:OD1	2.26	0.65
2:H:106:PHE:N	3:L:37:TYR:OH	2.30	0.64
1:A:387:LEU:HA	1:A:390:LEU:HD12	1.79	0.64

Continued on next page...

Continued from previous page...

Atom-1	Atom-2	Interatomic distance (Å)	Clash overlap (Å)
3:K:50:TYR:CD2	3:K:51:GLU:HG3	2.33	0.64
2:H:99:LEU:HD13	2:H:101:TRP:O	1.98	0.64
2:G:206:HIS:CD2	2:G:208:PRO:HD2	2.33	0.64
2:G:106:PHE:N	3:I:37:TYR:OH	2.21	0.64
1:A:409:GLN:HA	1:A:414:GLN:HG3	1.80	0.64
2:D:70:ILE:HD11	2:D:79:LEU:HD11	1.78	0.64
2:G:30:THR:O	2:G:53:GLU:HB2	1.98	0.63
1:B:347:PHE:CE2	1:B:399:SER:HB2	2.33	0.63
2:D:30:THR:HG22	2:D:74:ASN:HB3	1.79	0.63
3:I:22:CYS:HB3	3:I:74:ALA:HB3	1.80	0.63
2:H:24:ALA:HB3	2:H:77:ASN:HB3	1.79	0.63
2:H:169:VAL:HA	2:H:188:VAL:HG12	1.81	0.63
3:L:35:GLN:HG3	3:L:50:TYR:HA	1.81	0.63
1:A:384:PRO:HG2	2:G:101:TRP:CZ3	2.34	0.62
2:H:175:VAL:HB	3:L:166:THR:HG22	1.82	0.62
1:A:369:TYR:CZ	2:G:101:TRP:HE3	2.18	0.62
1:B:457:ARG:NE	1:B:467:ASP:OD2	2.23	0.62
2:H:101:TRP:NE1	2:H:104:GLY:HA3	2.13	0.62
3:K:139:LEU:HD23	3:K:179:SER:HB3	1.82	0.62
2:D:175:VAL:HB	3:F:166:THR:HG22	1.80	0.62
2:H:2:VAL:HG11	2:H:27:LEU:HD23	1.81	0.61
1:E:338:PHE:HE1	1:E:358:ILE:HG13	1.64	0.61
1:C:336:CYS:SG	1:C:363:ALA:HB2	2.40	0.61
1:C:470:THR:O	1:C:470:THR:OG1	2.09	0.61
2:H:12:VAL:HG21	2:H:18:LEU:HB2	1.83	0.61
2:D:169:VAL:HA	2:D:188:VAL:HG12	1.81	0.61
3:I:112:GLN:HB3	3:I:113:PRO:HD2	1.82	0.61
3:K:86:GLU:HG3	3:K:107:LEU:O	1.99	0.61
3:L:3:MET:O	3:L:4:LEU:HD23	2.00	0.61
3:L:148:VAL:HG12	3:L:201:HIS:HB2	1.82	0.61
1:B:378:LYS:NZ	3:F:30:ALA:O	2.29	0.61
1:C:475:ALA:HB3	1:C:487:ASN:HB3	1.83	0.61
2:G:29:PHE:O	2:G:72:ARG:NH2	2.34	0.60
2:J:52:LYS:O	2:J:72:ARG:NH1	2.34	0.60
3:K:22:CYS:HB3	3:K:74:ALA:HB3	1.83	0.60
3:L:81:LEU:HD13	3:L:109:VAL:HG22	1.82	0.60
1:A:376:THR:HA	2:G:103:ARG:HH12	1.67	0.60
1:B:502:GLY:O	1:B:506:GLN:HG3	2.01	0.60
1:E:378:LYS:HA	3:L:33:TYR:CE1	2.36	0.60
3:I:22:CYS:N	3:I:74:ALA:O	2.34	0.60
3:I:64:SER:O	3:I:76:LEU:HD12	2.01	0.60

Continued on next page...

Continued from previous page...

Atom-1	Atom-2	Interatomic distance (Å)	Clash overlap (Å)
3:I:114:LYS:HD3	3:I:202:GLU:HG3	1.82	0.60
1:B:369:TYR:CE2	1:B:384:PRO:HB2	2.37	0.60
3:L:62:ARG:O	3:L:79:SER:N	2.34	0.60
1:B:340:GLU:O	1:B:344:ALA:HB2	2.02	0.59
3:L:50:TYR:CD2	3:L:51:GLU:HG3	2.37	0.59
2:D:73:ASP:OD2	2:D:76:LYS:NZ	2.26	0.59
2:D:154:GLU:HB3	2:D:155:PRO:HA	1.84	0.59
2:H:47:TRP:CD1	3:L:99:VAL:HB	2.37	0.59
2:G:100:ARG:HG2	2:G:101:TRP:HD1	1.67	0.59
1:C:384:PRO:HG2	2:J:101:TRP:HZ3	1.68	0.59
3:F:50:TYR:HD2	3:F:51:GLU:HG3	1.67	0.59
1:A:378:LYS:NZ	3:I:30:ALA:O	2.36	0.58
1:C:347:PHE:CE2	1:C:509:ARG:HB3	2.38	0.58
2:H:185:SER:HB2	3:L:139:LEU:HD21	1.85	0.58
2:D:29:PHE:HZ	2:D:79:LEU:HB2	1.68	0.58
2:D:47:TRP:HB2	3:F:101:PHE:CE2	2.38	0.58
2:D:52:LYS:O	2:D:72:ARG:NH1	2.36	0.58
1:B:337:PRO:HD2	1:B:358:ILE:HD12	1.86	0.58
2:J:160:TRP:HA	2:J:202:CYS:HA	1.85	0.58
2:J:101:TRP:N	2:J:101:TRP:HD1	1.99	0.58
1:E:357:ARG:NH1	1:E:394:ASN:OD1	2.36	0.58
1:C:455:LEU:HD23	1:C:493:GLN:HE21	1.69	0.58
2:H:36:TRP:HE1	2:H:79:LEU:HG	1.69	0.58
1:E:347:PHE:CE2	1:E:399:SER:HB2	2.40	0.57
2:D:106:PHE:N	3:F:37:TYR:OH	2.26	0.57
2:G:145:GLY:HA3	2:G:187:VAL:HA	1.85	0.57
3:F:37:TYR:CE1	3:F:47:VAL:HG22	2.37	0.57
3:K:35:GLN:HB2	3:K:92:GLN:HG3	1.86	0.57
2:D:37:VAL:HA	2:D:48:VAL:HG23	1.85	0.57
2:J:36:TRP:CG	2:J:81:LEU:HD22	2.40	0.57
2:D:92:ALA:HB3	2:D:94:TYR:CE1	2.40	0.57
1:C:393:THR:HA	1:C:522:ALA:HA	1.86	0.56
1:A:388:ASN:O	1:A:526:GLY:HA3	2.05	0.56
2:G:53:GLU:HA	2:G:72:ARG:NH1	2.21	0.56
3:I:23:THR:HA	3:I:73:SER:HA	1.87	0.56
1:E:354[B]:ASN:OD1	1:E:355:ARG:N	2.38	0.56
1:B:402:ILE:HD11	1:B:407:VAL:HA	1.88	0.56
2:D:47:TRP:CD1	3:F:99:VAL:HB	2.40	0.56
2:G:105:ASN:HB3	3:I:35:GLN:HG2	1.87	0.56
2:G:34:MET:HB3	2:G:79:LEU:HD22	1.86	0.56
1:C:435:ALA:HB2	1:C:510:VAL:HG22	1.88	0.56

Continued on next page...

Continued from previous page...

Atom-1	Atom-2	Interatomic distance (Å)	Clash overlap (Å)
2:G:158:VAL:HG22	2:G:204:VAL:HG22	1.88	0.56
1:A:363:ALA:O	1:A:527:PRO:HD3	2.06	0.56
2:H:7:SER:O	2:H:20:ILE:HG23	2.05	0.56
2:J:106:PHE:HD1	3:K:37:TYR:HH	1.52	0.56
1:C:498:GLN:O	1:C:500:THR:N	2.39	0.56
1:C:418:ILE:HA	1:C:422:ASN:HD22	1.71	0.55
3:F:36:TRP:N	3:F:49:ILE:O	2.30	0.55
1:A:393:THR:HG21	1:A:518:LEU:HB2	1.88	0.55
2:H:145:GLY:HA2	2:H:160:TRP:HH2	1.72	0.55
1:E:393:THR:HA	1:E:522:ALA:HA	1.89	0.55
3:I:50:TYR:CD2	3:I:51:GLU:HG3	2.42	0.55
1:A:396:TYR:HB2	1:A:514:SER:HB2	1.88	0.54
1:A:428:ASP:OD1	1:A:428:ASP:N	2.40	0.54
1:C:365:TYR:CD2	1:C:387:LEU:HB3	2.41	0.54
1:C:336:CYS:HB2	1:C:363:ALA:HB2	1.90	0.54
3:F:37:TYR:HE2	3:F:92:GLN:HG2	1.72	0.54
3:I:36:TRP:HB2	3:I:49:ILE:HB	1.89	0.54
3:K:114:LYS:HD3	3:K:202:GLU:HG3	1.90	0.54
2:D:24:ALA:HB3	2:D:77:ASN:HB3	1.89	0.54
3:I:96:THR:HG23	3:I:97:PRO:CD	2.35	0.54
3:K:37:TYR:HE2	3:K:92:GLN:HG2	1.71	0.54
3:K:36:TRP:HB2	3:K:49:ILE:HB	1.90	0.54
1:A:442:ASP:OD1	1:A:509:ARG:NH2	2.41	0.53
2:D:13:GLN:HG2	2:D:119:SER:HB3	1.91	0.53
2:J:101:TRP:HZ2	3:K:51:GLU:CG	2.20	0.53
2:D:7:SER:OG	2:D:21:SER:OG	2.26	0.53
2:D:33:TRP:CE2	2:D:102:LEU:HD13	2.43	0.53
3:F:50:TYR:CD2	3:F:51:GLU:HG3	2.43	0.53
1:C:403:ARG:CG	1:C:505:TYR:HA	2.38	0.53
2:G:37:VAL:HA	2:G:48:VAL:HG23	1.91	0.53
2:J:106:PHE:N	3:K:37:TYR:OH	2.37	0.53
2:G:129:PRO:O	3:I:125:SER:HB3	2.08	0.53
1:A:369:TYR:CZ	2:G:101:TRP:CE3	2.95	0.53
2:D:101:TRP:HZ2	3:F:51:GLU:HG2	1.74	0.53
2:D:206:HIS:CD2	2:D:208:PRO:HD2	2.43	0.53
3:L:34:VAL:HG22	3:L:93:SER:HB2	1.90	0.52
3:I:148:VAL:HG12	3:I:201:HIS:HB2	1.90	0.52
1:C:438:SER:HB3	1:C:509:ARG:HG3	1.90	0.52
2:H:145:GLY:HA2	2:H:160:TRP:CH2	2.45	0.52
3:L:37:TYR:HE1	3:L:47:VAL:HG22	1.75	0.52
3:I:119:VAL:O	3:I:208:LYS:NZ	2.43	0.52

Continued on next page...

Continued from previous page...

Atom-1	Atom-2	Interatomic distance (Å)	Clash overlap (Å)
2:H:27:LEU:HD13	2:H:98:ARG:NH1	2.24	0.52
2:H:33:TRP:CZ2	2:H:52:LYS:HG3	2.45	0.52
3:F:35:GLN:HG3	3:F:50:TYR:HA	1.91	0.52
2:G:190:VAL:HG23	2:G:195:LEU:CD1	2.39	0.52
1:A:422:ASN:N	1:A:422:ASN:HD22	2.08	0.52
2:H:144:LEU:HB2	2:H:217:VAL:HG11	1.91	0.51
2:H:125:PRO:HD3	2:H:206:HIS:ND1	2.25	0.51
2:G:119:SER:OG	2:G:179:SER:O	2.25	0.51
3:F:27:GLY:O	3:F:72:ASN:ND2	2.41	0.51
2:G:91:THR:HG23	2:G:116:THR:HA	1.93	0.51
3:K:37:TYR:HE1	3:K:47:VAL:HG22	1.75	0.51
1:B:395:VAL:HG22	1:B:515:PHE:HD1	1.75	0.51
1:A:393:THR:HA	1:A:522:ALA:HA	1.92	0.51
1:E:389:ASP:OD1	1:E:389:ASP:N	2.42	0.51
3:F:33:TYR:HB3	3:F:51:GLU:HA	1.93	0.51
2:J:203:ASN:HB3	2:J:212:LYS:NZ	2.26	0.51
1:C:454:ARG:NH1	1:C:469:SER:O	2.43	0.51
3:L:37:TYR:CE2	3:L:92:GLN:HG2	2.44	0.51
2:D:2:VAL:HG11	2:D:108:HIS:CG	2.46	0.51
2:D:106:PHE:H	3:F:37:TYR:HH	1.56	0.51
1:E:528:LYS:HB2	1:E:528:LYS:HZ2	1.75	0.51
3:L:124:PRO:HD3	3:L:136:LEU:HG	1.93	0.51
2:G:145:GLY:HA3	2:G:187:VAL:HG12	1.93	0.51
2:G:201:ILE:HG12	2:G:216:LYS:HG2	1.93	0.51
2:J:105:ASN:HD22	3:K:47:VAL:HG21	1.76	0.51
1:B:349:SER:HB3	1:B:452:LEU:O	2.11	0.50
2:D:100:ARG:NH2	2:D:107:ASP:OD2	2.44	0.50
2:J:35:ASN:HD21	2:J:99:LEU:HD11	1.76	0.50
3:L:10:VAL:HG11	3:L:20:ILE:HG12	1.93	0.50
1:A:370:ASN:HB3	2:G:33:TRP:HE1	1.76	0.50
1:C:403:ARG:HD3	1:C:495:TYR:CD1	2.46	0.50
2:J:175:VAL:HB	3:K:166:THR:HG22	1.93	0.50
3:K:86:GLU:HB2	3:K:109:VAL:HG23	1.94	0.50
1:A:357:ARG:HG3	1:A:396:TYR:CE1	2.45	0.50
1:B:521:PRO:O	1:B:523:THR:HG23	2.12	0.50
1:E:337:PRO:HD2	1:E:358:ILE:HD12	1.92	0.50
3:K:86:GLU:OE1	3:K:108:THR:HG23	2.12	0.50
2:H:2:VAL:HG22	2:H:26:GLY:HA3	1.92	0.50
2:D:38:ARG:NH2	2:D:46:GLU:OE2	2.41	0.50
3:F:153:LYS:HB2	3:F:196:SER:HB2	1.94	0.50
3:F:128:GLU:OE2	3:F:135:THR:N	2.44	0.50

Continued on next page...

Continued from previous page...

Atom-1	Atom-2	Interatomic distance (Å)	Clash overlap (Å)
2:G:103:ARG:HD3	3:I:94:TYR:HD2	1.76	0.50
2:G:121:SER:HA	2:G:152:PHE:CD2	2.46	0.50
1:B:365:TYR:CD2	1:B:387:LEU:HB3	2.46	0.50
1:C:503:VAL:HA	1:C:506:GLN:CG	2.42	0.50
3:L:28:TYR:O	3:L:31:ASN:HB2	2.10	0.50
3:L:35:GLN:OE1	3:L:51:GLU:N	2.27	0.50
3:F:171:GLN:NE2	3:F:173:ASN:OD1	2.44	0.50
1:E:401:VAL:HG22	1:E:509:ARG:HG2	1.94	0.49
1:E:453:TYR:N	1:E:453:TYR:HD1	2.10	0.49
3:L:36:TRP:CE2	3:L:76:LEU:HB2	2.46	0.49
3:K:40:ARG:HG2	3:K:87:ALA:HB2	1.94	0.49
2:D:13:GLN:HA	2:D:119:SER:HB3	1.93	0.49
1:A:474:GLN:OE1	1:A:479:PRO:HA	2.12	0.49
2:H:99:LEU:HB3	2:H:106:PHE:HE1	1.74	0.49
1:B:455:LEU:HD12	1:B:455:LEU:O	2.12	0.49
2:H:47:TRP:CG	3:L:99:VAL:HB	2.48	0.49
2:D:190:VAL:HG11	2:D:200:TYR:CZ	2.47	0.49
3:I:4:LEU:HB3	3:I:22:CYS:SG	2.52	0.49
2:H:36:TRP:NE1	2:H:79:LEU:HG	2.27	0.49
3:K:36:TRP:CH2	3:K:91:CYS:HB3	2.47	0.49
1:E:447:GLY:HA2	1:E:498:GLN:HG3	1.95	0.49
1:C:369:TYR:HE2	2:J:102:LEU:N	2.11	0.49
3:K:36:TRP:CZ3	3:K:91:CYS:HB3	2.47	0.49
2:H:91:THR:HG23	2:H:116:THR:HA	1.93	0.49
2:H:101:TRP:HZ2	3:L:51:GLU:CG	2.19	0.49
3:K:150:VAL:HA	3:K:198:GLN:O	2.13	0.49
1:C:384:PRO:HG2	2:J:101:TRP:CZ3	2.47	0.48
2:J:83:MET:HE1	2:J:115:VAL:HG21	1.94	0.48
1:A:395:VAL:HA	1:A:514:SER:O	2.12	0.48
1:B:353:TRP:CG	1:B:423:TYR:HD1	2.30	0.48
1:C:359:SER:HB3	1:C:394:ASN:OD1	2.13	0.48
2:H:99:LEU:HB3	2:H:106:PHE:CD1	2.49	0.48
2:J:24:ALA:HB3	2:J:77:ASN:HB3	1.95	0.48
3:I:114:LYS:NZ	3:I:202:GLU:OE1	2.34	0.48
1:B:364:ASP:O	1:B:367:VAL:HB	2.14	0.48
3:F:2:PHE:HA	3:F:26:ASN:HB2	1.95	0.48
1:B:391:CYS:HB3	1:B:522:ALA:HB1	1.95	0.48
1:C:380:TYR:O	1:C:430:THR:HA	2.12	0.48
3:L:107:LEU:HD12	3:L:108:THR:N	2.28	0.48
3:F:11:SER:HB2	3:F:110:LEU:HD21	1.96	0.48
1:C:517:LEU:HA	1:C:517:LEU:HD23	1.56	0.48

Continued on next page...

Continued from previous page...

Atom-1	Atom-2	Interatomic distance (Å)	Clash overlap (Å)
2:G:7:SER:O	2:G:20:ILE:HG23	2.14	0.48
2:H:158:VAL:HG22	2:H:204:VAL:HG22	1.96	0.47
3:K:66:SER:OG	3:K:75:SER:HB2	2.14	0.47
1:E:453:TYR:N	1:E:453:TYR:CD1	2.81	0.47
1:B:350:VAL:HG21	1:B:418:ILE:HG23	1.97	0.47
2:G:12:VAL:HG23	2:G:117:VAL:HG22	1.95	0.47
2:G:33:TRP:CZ2	2:G:52:LYS:HG3	2.48	0.47
1:A:417:ASN:HB2	3:L:61:ASP:OD2	2.14	0.47
3:F:6:GLN:NE2	3:F:105:THR:OG1	2.47	0.47
1:C:369:TYR:HE2	2:J:102:LEU:H	1.61	0.47
3:K:168:PRO:HA	3:K:178:ALA:HB2	1.96	0.47
1:C:392:PHE:HA	1:C:517:LEU:HD21	1.96	0.47
1:C:453:TYR:O	1:C:492:LEU:HA	2.14	0.47
2:H:30:THR:HG22	2:H:74:ASN:HB3	1.96	0.47
2:D:11:LEU:HD21	2:D:119:SER:HA	1.97	0.47
1:A:364:ASP:O	1:A:367:VAL:HB	2.15	0.47
2:H:101:TRP:CZ2	3:L:51:GLU:HG2	2.31	0.47
3:L:50:TYR:HD2	3:L:51:GLU:HG3	1.80	0.47
3:I:37:TYR:HE1	3:I:47:VAL:HG22	1.80	0.47
3:K:77:ILE:HD12	3:K:77:ILE:N	2.30	0.47
3:L:154:ALA:HB2	3:L:195:TYR:CE2	2.50	0.47
2:D:33:TRP:CD2	2:D:102:LEU:HD13	2.50	0.47
2:D:201:ILE:HG12	2:D:216:LYS:HG2	1.95	0.47
1:B:350:VAL:HG22	1:B:422:ASN:HB3	1.97	0.47
1:C:444:LYS:O	1:C:498:GLN:HA	2.15	0.47
2:G:106:PHE:H	3:I:37:TYR:HH	1.56	0.47
1:C:403:ARG:HG2	1:C:505:TYR:HA	1.96	0.47
2:H:154:GLU:HB3	2:H:155:PRO:HA	1.97	0.47
3:I:86:GLU:HG3	3:I:109:VAL:H	1.80	0.46
1:C:336:CYS:CB	1:C:363:ALA:HB2	2.45	0.46
1:C:396:TYR:O	1:C:513:LEU:HA	2.14	0.46
1:A:455:LEU:HG	1:A:456:PHE:CE2	2.50	0.46
1:B:336:CYS:HB2	1:B:363:ALA:HB2	1.97	0.46
1:B:441:LEU:HB2	1:B:509:ARG:HH21	1.80	0.46
1:A:490:PHE:CD1	1:A:491:PRO:HD2	2.51	0.46
1:B:347:PHE:CG	1:B:509:ARG:HD3	2.51	0.46
1:B:409:GLN:OE1	1:B:419:ALA:N	2.37	0.46
2:D:33:TRP:CH2	2:D:52:LYS:HG3	2.50	0.46
3:I:121:LEU:HD21	3:I:210:VAL:HG22	1.98	0.46
2:J:6:GLU:HG3	2:J:22:CYS:SG	2.56	0.46
2:G:174:ALA:HB1	2:G:182:TYR:HB3	1.98	0.46

Continued on next page...

Continued from previous page...

Atom-1	Atom-2	Interatomic distance (Å)	Clash overlap (Å)
1:E:379:CYS:HA	1:E:432:CYS:HA	1.98	0.46
2:D:100:ARG:HG2	2:D:101:TRP:HD1	1.81	0.46
3:L:24:GLY:O	3:L:72:ASN:ND2	2.48	0.46
3:L:36:TRP:CD2	3:L:76:LEU:HB2	2.50	0.46
3:I:94:TYR:CZ	3:I:96:THR:O	2.69	0.46
1:B:359:SER:HB3	1:B:394:ASN:OD1	2.16	0.46
2:D:171:THR:HG23	2:D:186:SER:HB2	1.96	0.46
3:K:154:ALA:HB2	3:K:195:TYR:CE2	2.51	0.46
1:A:430:THR:O	1:A:430:THR:OG1	2.33	0.45
2:H:206:HIS:CD2	2:H:208:PRO:HD2	2.52	0.45
2:D:177:GLN:HG2	3:F:164:GLU:HG3	1.98	0.45
2:G:175:VAL:O	2:G:182:TYR:HA	2.16	0.45
1:B:443:SER:HB3	1:B:499:PRO:HD3	1.99	0.45
2:G:34:MET:O	2:G:50:ASN:HB2	2.16	0.45
3:I:9:SER:HB3	3:I:147:ALA:CB	2.46	0.45
1:E:350:VAL:HA	1:E:400:PHE:HB2	1.98	0.45
1:A:374:PHE:N	1:A:374:PHE:CD1	2.82	0.45
1:B:369:TYR:OH	1:B:384:PRO:HG2	2.17	0.45
1:C:376:THR:O	1:C:434:ILE:HA	2.16	0.45
2:G:105:ASN:CA	3:I:35:GLN:HG2	2.47	0.45
1:B:379:CYS:HA	1:B:432:CYS:HA	1.98	0.45
1:B:447:GLY:HA2	1:B:498:GLN:HG3	1.99	0.45
2:H:105:ASN:HA	3:L:35:GLN:HG2	1.97	0.45
2:J:101:TRP:HD1	2:J:101:TRP:H	1.60	0.45
3:F:134:ALA:HB3	3:F:184:LEU:O	2.17	0.45
2:G:175:VAL:HG21	3:I:164:GLU:HB3	1.98	0.45
2:J:36:TRP:CE2	2:J:81:LEU:HB2	2.52	0.45
1:C:337:PRO:HD2	1:C:358:ILE:HD12	1.98	0.45
2:J:71:SER:OG	2:J:80:TYR:HB2	2.17	0.45
2:J:101:TRP:CZ2	3:K:51:GLU:CG	2.98	0.45
2:J:128:PHE:HB3	3:K:125:SER:OG	2.17	0.45
1:C:352:ALA:HB1	1:C:466:ARG:NH2	2.32	0.44
3:K:38:GLN:O	3:K:45:PRO:HA	2.16	0.44
3:K:185:THR:H	3:K:188:GLN:HB2	1.82	0.44
1:C:418:ILE:HG23	1:C:422:ASN:HB2	1.99	0.44
3:F:143:PHE:HE2	3:F:146:GLY:HA2	1.82	0.44
3:I:81:LEU:HD23	3:I:81:LEU:HA	1.84	0.44
3:K:127:GLU:OE1	3:K:127:GLU:N	2.48	0.44
1:C:384:PRO:HA	1:C:387:LEU:HD12	2.00	0.44
2:D:11:LEU:HD22	2:D:153:PRO:HD3	1.98	0.44
1:A:346:ARG:HH21	1:A:450:ASN:HB2	1.83	0.44

Continued on next page...

Continued from previous page...

Atom-1	Atom-2	Interatomic distance (Å)	Clash overlap (Å)
1:C:359:SER:HA	1:C:524:VAL:HG22	2.00	0.44
1:C:408:ARG:HH21	1:C:409:GLN:HG2	1.82	0.44
1:C:447:GLY:HA2	1:C:497:PHE:O	2.18	0.44
2:H:92:ALA:HB3	2:H:94:TYR:CE1	2.53	0.44
2:H:101:TRP:CD1	2:H:104:GLY:HA3	2.52	0.44
2:G:20:ILE:HD11	2:G:115:VAL:HG21	1.99	0.44
2:G:20:ILE:HD11	2:G:115:VAL:CG2	2.48	0.44
2:J:204:VAL:O	2:J:212:LYS:HG3	2.18	0.44
3:K:37:TYR:CE2	3:K:92:GLN:HG2	2.51	0.44
1:A:368:LEU:HD23	1:A:368:LEU:HA	1.76	0.44
2:H:34:MET:HB3	2:H:79:LEU:HD13	1.98	0.44
2:D:144:LEU:HA	3:F:122:PHE:HZ	1.83	0.44
2:G:105:ASN:HA	3:I:35:GLN:HG2	2.00	0.44
2:G:187:VAL:HG11	3:I:122:PHE:CE2	2.53	0.44
3:K:96:THR:HB	3:K:97:PRO:CD	2.39	0.44
1:E:364:ASP:OD1	1:E:366:SER:HB2	2.17	0.44
1:E:447:GLY:HA2	1:E:497:PHE:O	2.18	0.44
3:L:153:LYS:HD3	3:L:158:PRO:HA	1.99	0.44
2:G:103:ARG:HD3	3:I:94:TYR:CD2	2.52	0.44
1:B:370:ASN:OD1	2:D:102:LEU:N	2.50	0.44
3:F:112:GLN:HB3	3:F:144:TYR:CE1	2.53	0.44
2:J:33:TRP:CZ2	2:J:52:LYS:HG3	2.53	0.44
1:E:361:CYS:O	1:E:524:VAL:HA	2.18	0.43
1:E:362:VAL:HG13	1:E:525:CYS:O	2.18	0.43
1:A:364:ASP:OD2	1:A:367:VAL:HG23	2.17	0.43
1:C:379:CYS:N	3:K:33:TYR:OH	2.41	0.43
3:F:143:PHE:CE2	3:F:146:GLY:HA2	2.53	0.43
2:J:156:VAL:HG13	2:J:184:LEU:HD13	2.00	0.43
3:L:171:GLN:OE1	3:L:177:ALA:HB2	2.17	0.43
3:K:34:VAL:N	3:K:52:ASP:OD1	2.42	0.43
1:A:419:ALA:O	1:A:424:LYS:HD3	2.18	0.43
1:B:336:CYS:N	1:B:361:CYS:HB2	2.32	0.43
1:E:517:LEU:HD23	1:E:517:LEU:HA	1.77	0.43
1:B:388:ASN:O	1:B:526:GLY:HA3	2.18	0.43
2:H:65:LYS:HD2	2:H:65:LYS:HA	1.85	0.43
3:F:36:TRP:CD2	3:F:76:LEU:HB2	2.53	0.43
2:J:203:ASN:HB3	2:J:212:LYS:HZ3	1.81	0.43
3:L:117:PRO:HA	3:L:143:PHE:HB3	2.00	0.43
1:B:366:SER:HA	1:B:369:TYR:HB3	1.99	0.43
2:H:176:LEU:HD13	2:H:182:TYR:CZ	2.53	0.43
2:D:21:SER:HA	2:D:79:LEU:O	2.18	0.43

Continued on next page...

Continued from previous page...

Atom-1	Atom-2	Interatomic distance (Å)	Clash overlap (Å)
2:D:173:PRO:HG2	3:F:169:SER:OG	2.19	0.43
3:I:50:TYR:CD1	3:I:56:PRO:HG3	2.53	0.43
1:A:387:LEU:HD23	1:A:390:LEU:HD12	2.00	0.43
2:H:35:ASN:N	2:H:35:ASN:ND2	2.67	0.43
2:D:68:PHE:CE1	2:D:83:MET:HB3	2.54	0.43
3:F:37:TYR:CE2	3:F:92:GLN:HG2	2.52	0.43
1:E:387:LEU:HD23	1:E:387:LEU:HA	1.87	0.43
2:H:11:LEU:HD23	2:H:122:THR:OG1	2.19	0.43
3:I:201:HIS:CE1	3:I:202:GLU:HG2	2.53	0.43
1:B:402:ILE:HG21	1:B:402:ILE:HD13	1.77	0.43
1:C:357:ARG:HG3	1:C:396:TYR:CE1	2.53	0.43
2:J:145:GLY:HA2	2:J:160:TRP:CH2	2.53	0.43
2:D:29:PHE:CZ	2:D:34:MET:HG3	2.54	0.43
1:C:402:ILE:HD11	1:C:407:VAL:HA	2.00	0.42
3:I:153:LYS:HB2	3:I:196:SER:HB2	2.01	0.42
2:J:33:TRP:CD2	2:J:102:LEU:HD13	2.54	0.42
1:B:393:THR:HG21	1:B:520:ALA:HB3	2.01	0.42
2:D:201:ILE:HG12	2:D:216:LYS:HA	2.00	0.42
2:G:168:GLY:O	2:G:188:VAL:HA	2.18	0.42
1:C:387:LEU:HD23	1:C:387:LEU:HA	1.82	0.42
2:D:33:TRP:CZ2	2:D:52:LYS:HG3	2.54	0.42
2:D:201:ILE:HG23	2:D:215:LYS:O	2.19	0.42
2:G:40:ALA:HB3	2:G:43:LYS:HE3	2.01	0.42
1:A:468:ILE:O	1:A:470:THR:HG23	2.18	0.42
3:L:121:LEU:HD12	3:L:137:VAL:O	2.20	0.42
1:E:443:SER:HB3	1:E:499:PRO:HD3	2.02	0.42
3:F:81:LEU:HD13	3:F:109:VAL:HG22	2.01	0.42
2:G:70:ILE:HG13	2:G:80:TYR:O	2.19	0.42
3:K:6:GLN:NE2	3:K:105:THR:OG1	2.46	0.42
3:F:166:THR:HG23	3:F:179:SER:O	2.20	0.42
1:E:336:CYS:SG	1:E:524:VAL:HG13	2.60	0.42
1:C:398:ASP:O	1:C:511:VAL:HA	2.20	0.42
1:C:503:VAL:O	1:C:506:GLN:N	2.35	0.42
3:I:194:SER:HB2	3:I:209:THR:CG2	2.50	0.42
2:J:53:GLU:HG2	2:J:54:ASP:N	2.34	0.42
3:K:50:TYR:HD2	3:K:51:GLU:HG3	1.81	0.42
2:G:84:ASN:O	2:G:85:SER:C	2.58	0.42
1:A:461:LEU:HA	1:A:461:LEU:HD23	1.71	0.42
1:B:447:GLY:HA2	1:B:497:PHE:O	2.20	0.42
2:H:22:CYS:HB2	2:H:36:TRP:CH2	2.55	0.42
1:A:398:ASP:OD2	1:A:423:TYR:OH	2.37	0.41

Continued on next page...

Continued from previous page...

Atom-1	Atom-2	Interatomic distance (Å)	Clash overlap (Å)
2:H:60:TYR:CZ	2:H:70:ILE:HG22	2.55	0.41
3:L:36:TRP:HB2	3:L:49:ILE:HB	2.02	0.41
3:L:40:ARG:NH2	3:L:84:GLU:O	2.53	0.41
1:B:439:ASN:OD1	1:B:506:GLN:HG2	2.21	0.41
1:C:498:GLN:O	1:C:500:THR:HG23	2.20	0.41
1:A:521:PRO:O	1:A:523:THR:HG23	2.19	0.41
2:H:203:ASN:HB3	2:H:212:LYS:NZ	2.35	0.41
1:E:403:ARG:CB	1:E:406:GLU:HG3	2.50	0.41
1:E:407:VAL:O	1:E:409:GLN:N	2.53	0.41
1:A:398:ASP:O	1:A:511:VAL:HA	2.20	0.41
2:G:101:TRP:HZ2	3:I:51:GLU:CD	2.24	0.41
1:A:378:LYS:HB2	1:A:378:LYS:HE3	1.82	0.41
1:A:426:PRO:HD3	1:A:464:PHE:CE1	2.55	0.41
1:C:347:PHE:CE2	1:C:399:SER:HB2	2.55	0.41
2:D:172:PHE:HD1	3:F:179:SER:HG	1.68	0.41
2:H:19:ARG:HB2	2:H:82:GLN:OE1	2.20	0.41
3:F:117:PRO:HA	3:F:143:PHE:HB3	2.02	0.41
1:A:393:THR:HG21	1:A:520:ALA:HB3	2.02	0.41
2:D:201:ILE:HD11	2:D:216:LYS:NZ	2.35	0.41
2:G:100:ARG:HG2	2:G:101:TRP:CD1	2.52	0.41
1:E:444:LYS:HG3	1:E:448:ASN:HB2	2.01	0.41
2:H:67:ARG:NH1	2:H:90:ASP:OD2	2.44	0.41
3:F:55:ARG:HD3	3:F:63:PHE:O	2.21	0.41
1:B:455:LEU:HD11	3:K:64:SER:OG	2.20	0.41
2:H:60:TYR:HB2	2:H:65:LYS:CD	2.50	0.41
2:D:4:LEU:HD12	2:D:109:TRP:C	2.41	0.41
2:D:144:LEU:HA	3:F:122:PHE:CZ	2.56	0.41
2:G:36:TRP:NE1	2:G:79:LEU:HG	2.36	0.41
2:G:102:LEU:HG	3:I:94:TYR:CE2	2.56	0.41
3:K:193:ARG:HA	3:K:193:ARG:HD3	1.84	0.41
1:A:497:PHE:CD2	1:A:507:PRO:HB3	2.56	0.41
1:B:358:ILE:HD13	1:B:358:ILE:HA	1.80	0.41
1:C:355:ARG:NE	1:C:398:ASP:OD1	2.36	0.41
2:H:176:LEU:HD13	2:H:182:TYR:CE2	2.55	0.41
3:I:3:MET:HG2	3:I:4:LEU:N	2.36	0.41
2:J:47:TRP:HB2	3:K:101:PHE:HE2	1.85	0.41
1:A:421:TYR:C	1:A:422:ASN:HD22	2.25	0.40
2:D:175:VAL:O	2:D:182:TYR:HA	2.20	0.40
2:G:36:TRP:NE1	2:G:80:TYR:O	2.54	0.40
2:D:71:SER:OG	2:D:80:TYR:HB2	2.21	0.40
2:D:125:PRO:HB3	2:D:151:TYR:HB3	2.03	0.40

Continued on next page...

Continued from previous page...

Atom-1	Atom-2	Interatomic distance (Å)	Clash overlap (Å)
1:E:338:PHE:CE1	1:E:358:ILE:HG13	2.50	0.40
3:I:60:PRO:HG2	3:I:63:PHE:CD1	2.56	0.40
2:J:175:VAL:O	2:J:182:TYR:HA	2.21	0.40
1:A:373:SER:HB2	1:A:374:PHE:CD1	2.56	0.40
2:H:68:PHE:HB3	2:H:81:LEU:HD11	2.03	0.40
2:D:83:MET:HE1	2:D:115:VAL:HG21	2.03	0.40
2:D:172:PHE:CD1	3:F:139:LEU:HD22	2.57	0.40
2:D:207:LYS:HE2	2:D:207:LYS:HB3	1.89	0.40
3:I:20:ILE:O	3:I:75:SER:HA	2.22	0.40
1:A:431:GLY:HA2	1:A:515:PHE:CE2	2.56	0.40
1:C:358:ILE:HD13	1:C:358:ILE:HA	1.86	0.40
1:C:403:ARG:HD3	1:C:495:TYR:HD1	1.85	0.40
2:G:87:ARG:N	2:G:90:ASP:OD2	2.45	0.40
2:G:121:SER:HA	2:G:152:PHE:CE2	2.57	0.40
3:K:34:VAL:HG22	3:K:93:SER:HB2	2.04	0.40

There are no symmetry-related clashes.

5.3 Torsion angles [i](#)

5.3.1 Protein backbone [i](#)

In the following table, the Percentiles column shows the percent Ramachandran outliers of the chain as a percentile score with respect to all X-ray entries followed by that with respect to entries of similar resolution.

The Analysed column shows the number of residues for which the backbone conformation was analysed, and the total number of residues.

Mol	Chain	Analysed	Favoured	Allowed	Outliers	Percentiles	
1	A	183/243 (75%)	173 (94%)	10 (6%)	0	100	100
1	B	183/243 (75%)	176 (96%)	7 (4%)	0	100	100
1	C	184/243 (76%)	174 (95%)	10 (5%)	0	100	100
1	E	184/243 (76%)	175 (95%)	9 (5%)	0	100	100
2	D	197/217 (91%)	190 (96%)	7 (4%)	0	100	100
2	G	186/217 (86%)	182 (98%)	4 (2%)	0	100	100
2	H	197/217 (91%)	188 (95%)	9 (5%)	0	100	100
2	J	188/217 (87%)	184 (98%)	4 (2%)	0	100	100

Continued on next page...

Continued from previous page...

Mol	Chain	Analysed	Favoured	Allowed	Outliers	Percentiles
3	F	210/216 (97%)	202 (96%)	7 (3%)	1 (0%)	29 67
3	I	210/216 (97%)	200 (95%)	9 (4%)	1 (0%)	29 67
3	K	210/216 (97%)	201 (96%)	8 (4%)	1 (0%)	29 67
3	L	210/216 (97%)	203 (97%)	6 (3%)	1 (0%)	29 67
All	All	2342/2704 (87%)	2248 (96%)	90 (4%)	4 (0%)	47 79

All (4) Ramachandran outliers are listed below:

Mol	Chain	Res	Type
3	F	97	PRO
3	L	113	PRO
3	K	112	GLN
3	I	113	PRO

5.3.2 Protein sidechains [i](#)

In the following table, the Percentiles column shows the percent sidechain outliers of the chain as a percentile score with respect to all X-ray entries followed by that with respect to entries of similar resolution.

The Analysed column shows the number of residues for which the sidechain conformation was analysed, and the total number of residues.

Mol	Chain	Analysed	Rotameric	Outliers	Percentiles
1	A	165/207 (80%)	157 (95%)	8 (5%)	25 61
1	B	164/207 (79%)	157 (96%)	7 (4%)	29 64
1	C	166/207 (80%)	162 (98%)	4 (2%)	49 77
1	E	166/207 (80%)	159 (96%)	7 (4%)	30 65
2	D	171/182 (94%)	162 (95%)	9 (5%)	22 58
2	G	164/182 (90%)	159 (97%)	5 (3%)	41 73
2	H	171/182 (94%)	168 (98%)	3 (2%)	59 82
2	J	166/182 (91%)	157 (95%)	9 (5%)	22 58
3	F	182/188 (97%)	179 (98%)	3 (2%)	62 84
3	I	182/188 (97%)	177 (97%)	5 (3%)	44 75
3	K	179/188 (95%)	174 (97%)	5 (3%)	43 74
3	L	182/188 (97%)	174 (96%)	8 (4%)	28 64

Continued on next page...

Continued from previous page...

Mol	Chain	Analysed	Rotameric	Outliers	Percentiles
All	All	2058/2308 (89%)	1985 (96%)	73 (4%)	35 69

All (73) residues with a non-rotameric sidechain are listed below:

Mol	Chain	Res	Type
1	E	345	THR
1	E	346	ARG
1	E	371	SER
1	E	430	THR
1	E	438	SER
1	E	453	TYR
1	E	528	LYS
1	A	345	THR
1	A	371	SER
1	A	399	SER
1	A	405	ASP
1	A	422	ASN
1	A	430	THR
1	A	498	GLN
1	A	528	LYS
1	B	345	THR
1	B	371	SER
1	B	408	ARG
1	B	430	THR
1	B	493	GLN
1	B	503	VAL
1	B	505	TYR
1	C	403	ARG
1	C	440	ASN
1	C	470	THR
1	C	528	LYS
2	H	35	ASN
2	H	96	CYS
2	H	203	ASN
3	L	3	MET
3	L	31	ASN
3	L	64	SER
3	L	67	ILE
3	L	81	LEU
3	L	96	THR
3	L	112	GLN
3	L	167	THR

Continued on next page...

Continued from previous page...

Mol	Chain	Res	Type
2	D	12	VAL
2	D	13	GLN
2	D	28	THR
2	D	53	GLU
2	D	96	CYS
2	D	103	ARG
2	D	157	THR
2	D	199	THR
2	D	203	ASN
3	F	3	MET
3	F	81	LEU
3	F	149	THR
2	G	6	GLU
2	G	29	PHE
2	G	96	CYS
2	G	156	VAL
2	G	176	LEU
3	I	75	SER
3	I	95	ASP
3	I	96	THR
3	I	109	VAL
3	I	149	THR
2	J	12	VAL
2	J	43	LYS
2	J	96	CYS
2	J	101	TRP
2	J	118	SER
2	J	157	THR
2	J	171	THR
2	J	189	THR
2	J	197	THR
3	K	46	THR
3	K	164	GLU
3	K	167	THR
3	K	205	THR
3	K	213	THR

Sometimes sidechains can be flipped to improve hydrogen bonding and reduce clashes. All (11) such sidechains are listed below:

Mol	Chain	Res	Type
1	E	460	ASN
1	B	334	ASN

Continued on next page...

Continued from previous page...

Mol	Chain	Res	Type
1	C	334	ASN
1	C	460	ASN
1	C	493	GLN
3	L	31	ASN
3	L	98	ASN
3	L	112	GLN
2	G	35	ASN
3	I	6	GLN
3	K	35	GLN

5.3.3 RNA [i](#)

There are no RNA molecules in this entry.

5.4 Non-standard residues in protein, DNA, RNA chains [i](#)

There are no non-standard protein/DNA/RNA residues in this entry.

5.5 Carbohydrates [i](#)

There are no monosaccharides in this entry.

5.6 Ligand geometry [i](#)

There are no ligands in this entry.

5.7 Other polymers [i](#)

There are no such residues in this entry.

5.8 Polymer linkage issues [i](#)

There are no chain breaks in this entry.

6 Fit of model and data [i](#)

6.1 Protein, DNA and RNA chains [i](#)

In the following table, the column labelled ‘#RSRZ > 2’ contains the number (and percentage) of RSRZ outliers, followed by percent RSRZ outliers for the chain as percentile scores relative to all X-ray entries and entries of similar resolution. The OWAB column contains the minimum, median, 95th percentile and maximum values of the occupancy-weighted average B-factor per residue. The column labelled ‘Q < 0.9’ lists the number of (and percentage) of residues with an average occupancy less than 0.9.

Mol	Chain	Analysed	<RSRZ>	#RSRZ>2	OWAB(Å ²)	Q<0.9
1	A	188/243 (77%)	-0.13	1 (0%) 91 86	48, 66, 102, 149	0
1	B	188/243 (77%)	0.03	1 (0%) 91 86	47, 60, 92, 134	0
1	C	189/243 (77%)	-0.22	1 (0%) 91 86	36, 57, 83, 115	0
1	E	189/243 (77%)	-0.07	3 (1%) 72 59	40, 58, 92, 128	0
2	D	203/217 (93%)	0.59	22 (10%) 5 3	45, 115, 212, 319	0
2	G	198/217 (91%)	1.33	50 (25%) 0 0	48, 179, 286, 344	0
2	H	203/217 (93%)	0.09	5 (2%) 57 43	35, 104, 211, 304	0
2	J	196/217 (90%)	1.42	67 (34%) 0 0	56, 181, 314, 408	0
3	F	212/216 (98%)	0.14	6 (2%) 53 37	37, 118, 214, 330	0
3	I	212/216 (98%)	1.71	78 (36%) 0 0	71, 173, 298, 331	0
3	K	212/216 (98%)	0.89	35 (16%) 1 1	31, 148, 294, 415	0
3	L	212/216 (98%)	-0.07	2 (0%) 84 75	28, 105, 203, 299	0
All	All	2402/2704 (88%)	0.49	271 (11%) 5 3	28, 100, 256, 415	0

All (271) RSRZ outliers are listed below:

Mol	Chain	Res	Type	RSRZ
2	G	29	PHE	11.7
2	G	190	VAL	11.4
3	I	136	LEU	9.9
3	I	152	TRP	9.8
3	K	123	PRO	8.8
3	K	210	VAL	8.4
2	G	97	ALA	8.3
2	J	1	GLU	8.3
3	I	110	LEU	8.2
3	I	108	THR	7.5
3	I	122	PHE	7.3

Continued on next page...

Continued from previous page...

Mol	Chain	Res	Type	RSRZ
3	I	109	VAL	7.3
3	K	196	SER	7.1
2	G	77	ASN	6.7
2	G	143	ALA	6.7
3	K	137	VAL	6.4
2	D	29	PHE	6.2
3	I	124	PRO	6.1
3	I	123	PRO	6.1
2	G	199	THR	6.0
2	G	185	SER	5.9
3	K	178	ALA	5.9
3	I	145	PRO	5.8
3	I	121	LEU	5.8
2	G	78	SER	5.7
2	G	74	ASN	5.5
3	K	117	PRO	5.5
3	I	93	SER	5.4
3	I	189	TRP	5.4
2	J	158	VAL	5.4
3	I	197	CYS	5.4
3	K	211	ALA	5.4
2	J	185	SER	5.3
3	I	34	VAL	5.3
2	J	147	LEU	5.3
3	K	136	LEU	5.3
3	I	137	VAL	5.3
3	K	120	THR	5.3
3	I	138	CYS	5.2
3	K	119	VAL	5.1
3	K	122	PHE	5.1
3	K	195	TYR	5.1
2	G	35	ASN	5.0
2	D	1	GLU	5.0
3	I	119	VAL	4.9
3	I	161	ALA	4.9
2	J	26	GLY	4.9
3	K	197	CYS	4.9
3	I	196	SER	4.8
3	K	209	THR	4.8
2	G	192	SER	4.8
3	K	179	SER	4.8
3	I	195	TYR	4.7

Continued on next page...

Continued from previous page...

Mol	Chain	Res	Type	RSRZ
2	J	124	GLY	4.7
3	I	107	LEU	4.7
3	I	182	LEU	4.7
2	J	2	VAL	4.6
3	I	162	GLY	4.5
3	I	210	VAL	4.5
3	I	211	ALA	4.5
2	G	157	THR	4.4
3	K	138	CYS	4.4
2	D	118	SER	4.4
3	I	190	LYS	4.3
2	J	187	VAL	4.3
2	G	216	LYS	4.3
2	G	130	LEU	4.3
3	I	120	THR	4.2
2	G	195	LEU	4.2
3	K	124	PRO	4.1
3	I	37	TYR	4.1
3	I	18	VAL	4.1
3	I	146	GLY	4.1
2	J	122	THR	4.0
3	I	114	LYS	4.0
3	I	135	THR	3.9
2	D	119	SER	3.9
3	K	148	VAL	3.9
2	G	73	ASP	3.9
2	G	156	VAL	3.8
3	I	117	PRO	3.8
3	I	48	VAL	3.8
2	G	217	VAL	3.8
3	L	213	THR	3.7
2	J	3	GLN	3.7
2	J	208	PRO	3.7
3	I	115	ALA	3.7
2	G	127	VAL	3.7
3	K	181	TYR	3.7
3	I	63	PHE	3.7
2	J	186	SER	3.7
2	J	29	PHE	3.6
2	G	109	TRP	3.6
2	J	36	TRP	3.6
2	J	197	THR	3.6

Continued on next page...

Continued from previous page...

Mol	Chain	Res	Type	RSRZ
2	J	156	VAL	3.6
3	I	186	PRO	3.6
2	G	131	ALA	3.6
3	I	57	SER	3.6
2	G	144	LEU	3.6
3	K	140	ILE	3.6
2	D	195	LEU	3.5
3	F	96	THR	3.5
2	J	126	SER	3.5
2	J	155	PRO	3.5
2	J	188	VAL	3.5
2	D	213	VAL	3.5
3	I	19	THR	3.5
2	J	8	GLY	3.5
3	K	96	THR	3.4
3	I	208	LYS	3.4
3	L	96	THR	3.4
2	J	79	LEU	3.4
2	J	210	ASN	3.4
2	D	28	THR	3.4
3	I	168	PRO	3.3
3	F	117	PRO	3.3
2	D	2	VAL	3.3
3	F	121	LEU	3.3
2	J	20	ILE	3.3
3	K	199	VAL	3.3
3	I	154	ALA	3.3
2	J	146	CYS	3.2
2	J	204	VAL	3.2
2	D	11	LEU	3.2
2	D	30	THR	3.2
2	J	127	VAL	3.2
2	J	144	LEU	3.2
2	H	29	PHE	3.2
2	G	132	PRO	3.2
3	I	111	GLY	3.2
2	G	160	TRP	3.2
2	G	198	GLN	3.2
2	G	26	GLY	3.1
3	I	9	SER	3.1
2	J	7	SER	3.1
3	I	131	ALA	3.1

Continued on next page...

Continued from previous page...

Mol	Chain	Res	Type	RSRZ
2	J	200	TYR	3.1
2	J	25	SER	3.1
2	J	153	PRO	3.0
2	G	38	ARG	3.0
3	K	184	LEU	3.0
2	H	30	THR	3.0
1	E	368	LEU	3.0
2	G	205	ASN	3.0
2	H	118	SER	3.0
2	J	27	LEU	3.0
3	K	139	LEU	3.0
2	J	191	PRO	3.0
2	D	27	LEU	2.9
3	I	52	ASP	2.9
2	J	172	PHE	2.9
2	J	171	THR	2.9
2	J	199	THR	2.9
2	G	76	LYS	2.9
3	I	159	VAL	2.9
3	I	118	SER	2.9
3	I	50	TYR	2.9
2	J	192	SER	2.9
2	J	118	SER	2.9
3	F	206	VAL	2.9
2	G	150	ASP	2.9
2	J	81	LEU	2.8
3	I	184	LEU	2.8
2	D	72	ARG	2.8
2	G	21	SER	2.8
2	G	172	PHE	2.8
2	J	178	SER	2.8
2	J	213	VAL	2.8
3	K	121	LEU	2.8
3	K	213	THR	2.8
3	I	212	PRO	2.7
2	G	158	VAL	2.7
2	J	9	GLY	2.7
2	J	115	VAL	2.7
2	G	72	ARG	2.7
2	G	210	ASN	2.7
3	I	181	TYR	2.7
3	I	72	ASN	2.7

Continued on next page...

Continued from previous page...

Mol	Chain	Res	Type	RSRZ
1	E	338	PHE	2.7
2	H	168	GLY	2.7
2	G	191	PRO	2.7
2	G	214	ASP	2.7
3	I	13	SER	2.7
2	J	143	ALA	2.7
2	D	125	PRO	2.7
2	J	28	THR	2.6
3	I	10	VAL	2.6
1	A	340	GLU	2.6
2	J	22	CYS	2.6
2	G	196	GLY	2.6
2	G	79	LEU	2.6
2	J	23	ALA	2.6
2	J	128	PHE	2.6
2	D	36	TRP	2.6
3	I	209	THR	2.6
3	I	8	HIS	2.5
3	K	152	TRP	2.5
2	J	112	GLY	2.5
3	I	78	ILE	2.5
2	D	57	GLU	2.5
3	I	144	TYR	2.5
2	J	109	TRP	2.5
2	J	216	LYS	2.5
2	G	71	SER	2.5
2	D	144	LEU	2.5
2	J	160	TRP	2.5
2	D	58	LYS	2.4
2	J	184	LEU	2.4
3	K	131	ALA	2.4
3	I	56	PRO	2.4
2	J	174	ALA	2.4
3	I	133	LYS	2.4
1	C	335	LEU	2.4
2	G	106	PHE	2.4
3	F	213	THR	2.4
1	B	502	GLY	2.4
2	J	96	CYS	2.4
2	J	125	PRO	2.4
2	G	70	ILE	2.3
3	I	132	ASN	2.3

Continued on next page...

Continued from previous page...

Mol	Chain	Res	Type	RSRZ
2	G	75	ALA	2.3
3	I	157	SER	2.3
2	J	16	GLY	2.3
2	G	149	LYS	2.3
3	I	112	GLN	2.3
3	I	28	TYR	2.3
2	H	1	GLU	2.3
3	K	130	GLN	2.3
3	I	33	TYR	2.3
3	I	14	PRO	2.3
3	K	116	ALA	2.3
2	G	155	PRO	2.3
2	J	148	VAL	2.2
2	G	168	GLY	2.2
2	G	36	TRP	2.2
3	I	163	VAL	2.2
3	I	160	LYS	2.2
1	E	370	ASN	2.2
2	D	97	ALA	2.2
2	J	94	TYR	2.2
2	J	113	THR	2.2
2	J	207	LYS	2.2
2	G	145	GLY	2.2
3	K	208	LYS	2.2
2	J	157	THR	2.2
2	J	123	LYS	2.2
3	F	97	PRO	2.2
2	J	37	VAL	2.2
2	D	200	TYR	2.2
3	I	156	SER	2.2
3	K	115	ALA	2.2
3	I	207	GLU	2.2
2	G	126	SER	2.1
2	J	80	TYR	2.1
3	I	39	GLN	2.1
3	I	113	PRO	2.1
3	K	198	GLN	2.1
2	D	183	SER	2.1
3	I	66	SER	2.1
2	J	68	PHE	2.1
3	I	11	SER	2.1
3	I	170	LYS	2.1

Continued on next page...

Continued from previous page...

Mol	Chain	Res	Type	RSRZ
2	J	24	ALA	2.1
2	D	20	ILE	2.1
2	G	27	LEU	2.1
3	I	147	ALA	2.0
3	I	185	THR	2.0
2	D	71	SER	2.0
3	K	207	GLU	2.0
3	K	31	ASN	2.0

6.2 Non-standard residues in protein, DNA, RNA chains [i](#)

There are no non-standard protein/DNA/RNA residues in this entry.

6.3 Carbohydrates [i](#)

There are no monosaccharides in this entry.

6.4 Ligands [i](#)

There are no ligands in this entry.

6.5 Other polymers [i](#)

There are no such residues in this entry.