



Full wwPDB EM Validation Report ⓘ

Nov 16, 2022 – 01:36 AM EST

PDB ID : 6WBM
EMDB ID : EMD-21593
Title : Cryo-EM structure of human Pannexin 1 channel N255A mutant
Authors : Lu, W.; Du, J.; Ruan, Z.
Deposited on : 2020-03-26
Resolution : 2.86 Å (reported)

This is a Full wwPDB EM Validation Report for a publicly released PDB entry.

We welcome your comments at validation@mail.wwpdb.org

A user guide is available at

<https://www.wwpdb.org/validation/2017/EMValidationReportHelp>

with specific help available everywhere you see the ⓘ symbol.

The types of validation reports are described at

<http://www.wwpdb.org/validation/2017/FAQs#types>.

The following versions of software and data (see [references ⓘ](#)) were used in the production of this report:

EMDB validation analysis : 0.0.1.dev43
Mogul : 1.8.5 (274361), CSD as541be (2020)
MolProbity : 4.02b-467
buster-report : 1.1.7 (2018)
Percentile statistics : 20191225.v01 (using entries in the PDB archive December 25th 2019)
MapQ : 1.9.9
Ideal geometry (proteins) : Engh & Huber (2001)
Ideal geometry (DNA, RNA) : Parkinson et al. (1996)
Validation Pipeline (wwPDB-VP) : 2.31.2

1 Overall quality at a glance

The following experimental techniques were used to determine the structure:

ELECTRON MICROSCOPY

The reported resolution of this entry is 2.86 Å.

Percentile scores (ranging between 0-100) for global validation metrics of the entry are shown in the following graphic. The table shows the number of entries on which the scores are based.

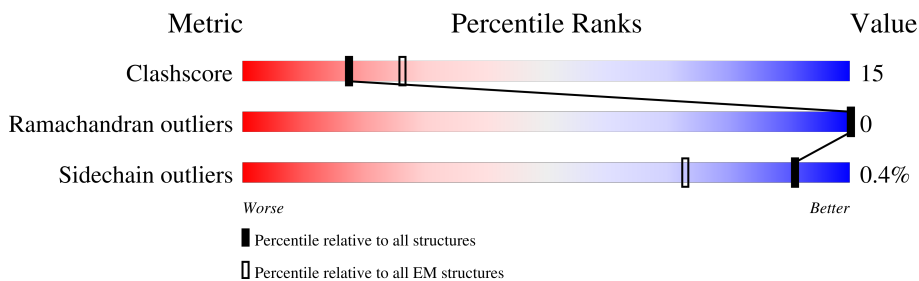

Metric	Whole archive (#Entries)	EM structures (#Entries)
Clashscore	158937	4297
Ramachandran outliers	154571	4023
Sidechain outliers	154315	3826

The table below summarises the geometric issues observed across the polymeric chains and their fit to the map. The red, orange, yellow and green segments of the bar indicate the fraction of residues that contain outliers for ≥ 3 , 2, 1 and 0 types of geometric quality criteria respectively. A grey segment represents the fraction of residues that are not modelled. The numeric value for each fraction is indicated below the corresponding segment, with a dot representing fractions $\leq 5\%$. The upper red bar (where present) indicates the fraction of residues that have poor fit to the EM map (all-atom inclusion $< 40\%$). The numeric value is given above the bar.

Mol	Chain	Length	Quality of chain
1	A	373	
1	B	373	
1	C	373	
1	D	373	
1	E	373	
1	F	373	
1	G	373	

2 Entry composition [i](#)

There are 5 unique types of molecules in this entry. The entry contains 19201 atoms, of which 0 are hydrogens and 0 are deuteriums.

In the tables below, the AltConf column contains the number of residues with at least one atom in alternate conformation and the Trace column contains the number of residues modelled with at most 2 atoms.

- Molecule 1 is a protein called Pannexin-1.

Mol	Chain	Residues	Atoms					AltConf	Trace
			Total	C	N	O	S		
1	A	341	2539	1682	406	440	11	0	0
1	B	341	2539	1682	406	440	11	0	0
1	C	341	2539	1682	406	440	11	0	0
1	D	341	2539	1682	406	440	11	0	0
1	E	341	2539	1682	406	440	11	0	0
1	F	341	2539	1682	406	440	11	0	0
1	G	341	2539	1682	406	440	11	0	0

There are 7 discrepancies between the modelled and reference sequences:

Chain	Residue	Modelled	Actual	Comment	Reference
A	255	ALA	ASN	engineered mutation	UNP Q96RD7
B	255	ALA	ASN	engineered mutation	UNP Q96RD7
C	255	ALA	ASN	engineered mutation	UNP Q96RD7
D	255	ALA	ASN	engineered mutation	UNP Q96RD7
E	255	ALA	ASN	engineered mutation	UNP Q96RD7
F	255	ALA	ASN	engineered mutation	UNP Q96RD7
G	255	ALA	ASN	engineered mutation	UNP Q96RD7

- Molecule 2 is PHOSPHATIDYLETHANOLAMINE (three-letter code: PTY) (formula: C₄₀H₈₀NO₈P).

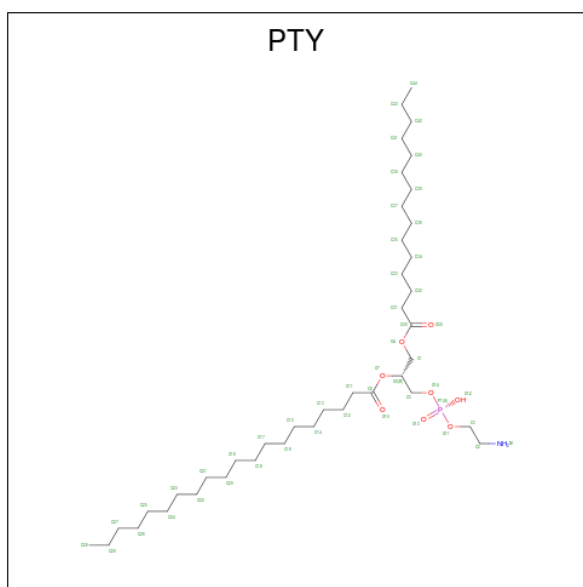

Mol	Chain	Residues	Atoms				AltConf	
			Total	C	N	O		P
2	A	1	81	61	2	16	2	0
2	A	1	81	61	2	16	2	0
2	B	1	81	61	2	16	2	0
2	B	1	81	61	2	16	2	0
2	C	1	81	61	2	16	2	0
2	C	1	81	61	2	16	2	0
2	D	1	81	61	2	16	2	0
2	D	1	81	61	2	16	2	0
2	E	1	81	61	2	16	2	0
2	E	1	81	61	2	16	2	0
2	F	1	81	61	2	16	2	0
2	F	1	81	61	2	16	2	0
2	G	1	81	61	2	16	2	0
2	G	1	81	61	2	16	2	0

- Molecule 3 is 1,2-Distearoyl-sn-glycerophosphoethanolamine (three-letter code: 3PE) (formula: $C_{41}H_{82}NO_8P$).

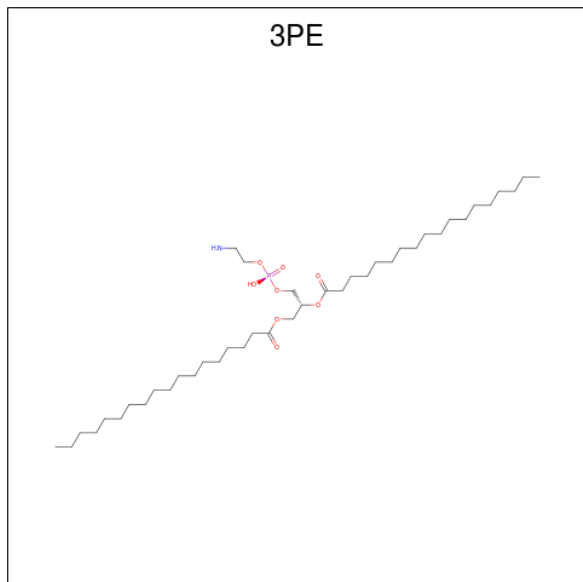

Mol	Chain	Residues	Atoms					AltConf
			Total	C	N	O	P	
3	A	1	Total 42	32	1	8	1	0
3	B	1	Total 42	32	1	8	1	0
3	C	1	Total 42	32	1	8	1	0
3	D	1	Total 42	32	1	8	1	0
3	E	1	Total 42	32	1	8	1	0
3	F	1	Total 42	32	1	8	1	0
3	G	1	Total 42	32	1	8	1	0

- Molecule 4 is DIACYL GLYCEROL (three-letter code: DGA) (formula: $C_{39}H_{76}O_5$).

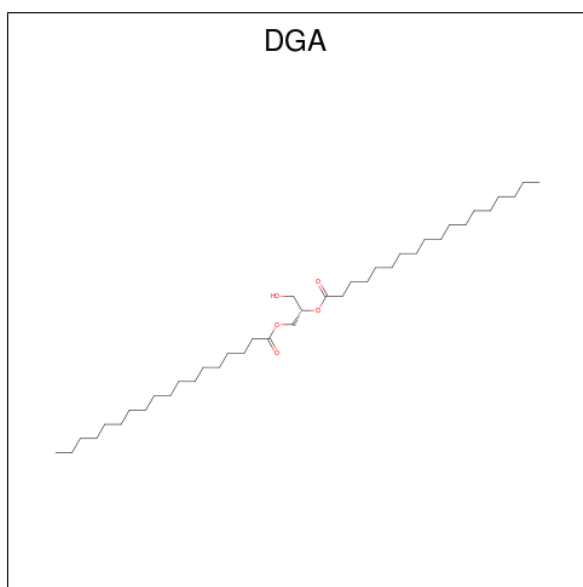

Mol	Chain	Residues	Atoms			AltConf
			Total	C	O	
4	A	1	50	40	10	0
4	A	1	50	40	10	0
4	B	1	25	20	5	0
4	C	1	25	20	5	0
4	D	1	25	20	5	0
4	E	1	25	20	5	0
4	F	1	25	20	5	0

- Molecule 5 is CHOLESTEROL (three-letter code: CLR) (formula: C₂₇H₄₆O).

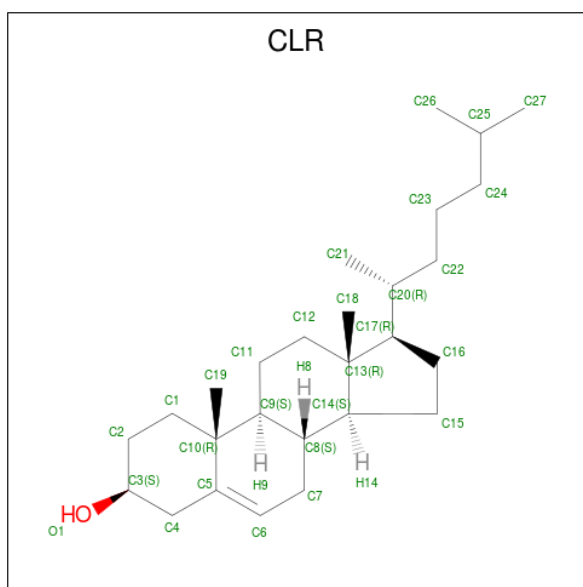

Mol	Chain	Residues	Atoms			AltConf
5	A	1	Total	C	O	0
			56	54	2	
5	A	1	Total	C	O	0
			56	54	2	
5	B	1	Total	C	O	0
			56	54	2	
5	B	1	Total	C	O	0
			56	54	2	
5	C	1	Total	C	O	0
			56	54	2	
5	C	1	Total	C	O	0
			56	54	2	
5	D	1	Total	C	O	0
			56	54	2	
5	D	1	Total	C	O	0
			56	54	2	
5	E	1	Total	C	O	0
			56	54	2	
5	E	1	Total	C	O	0
			56	54	2	
5	F	1	Total	C	O	0
			56	54	2	
5	F	1	Total	C	O	0
			56	54	2	
5	G	1	Total	C	O	0
			56	54	2	
5	G	1	Total	C	O	0
			56	54	2	

3 Residue-property plots

These plots are drawn for all protein, RNA, DNA and oligosaccharide chains in the entry. The first graphic for a chain summarises the proportions of the various outlier classes displayed in the second graphic. The second graphic shows the sequence view annotated by issues in geometry and atom inclusion in map density. Residues are color-coded according to the number of geometric quality criteria for which they contain at least one outlier: green = 0, yellow = 1, orange = 2 and red = 3 or more. A red diamond above a residue indicates a poor fit to the EM map for this residue (all-atom inclusion < 40%). Stretches of 2 or more consecutive residues without any outlier are shown as a green connector. Residues present in the sample, but not in the model, are shown in grey.

- Molecule 1: Pannexin-1

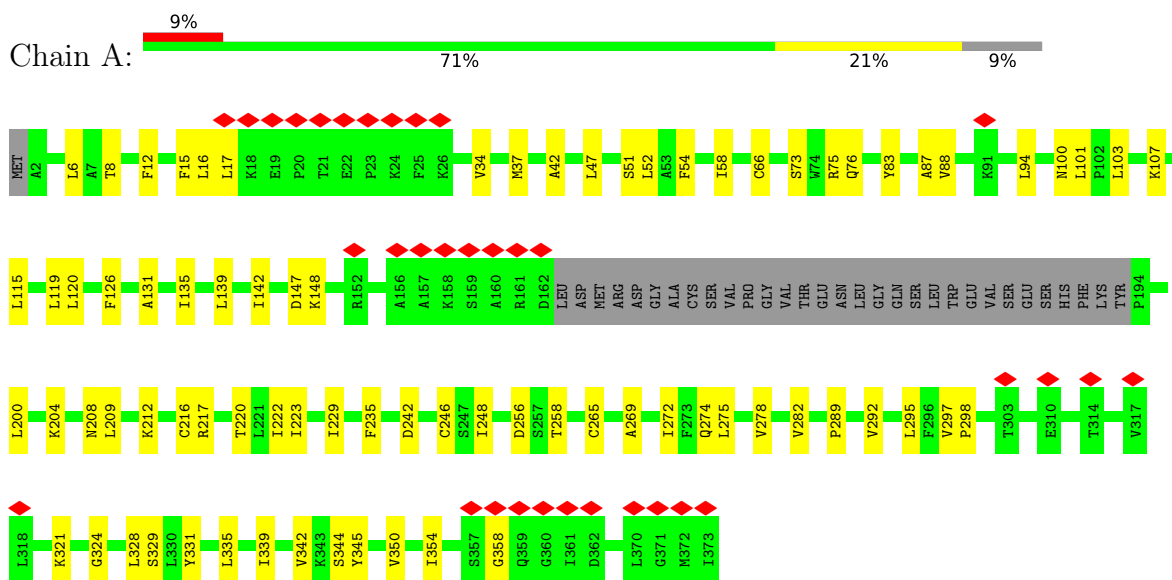

- Molecule 1: Pannexin-1

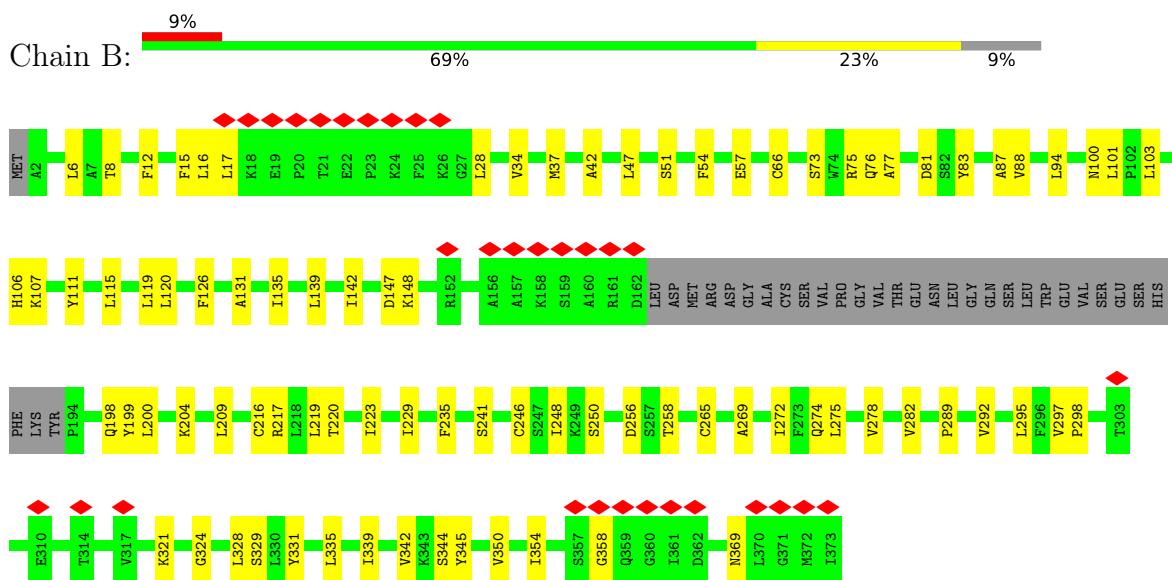

- Molecule 1: Pannexin-1

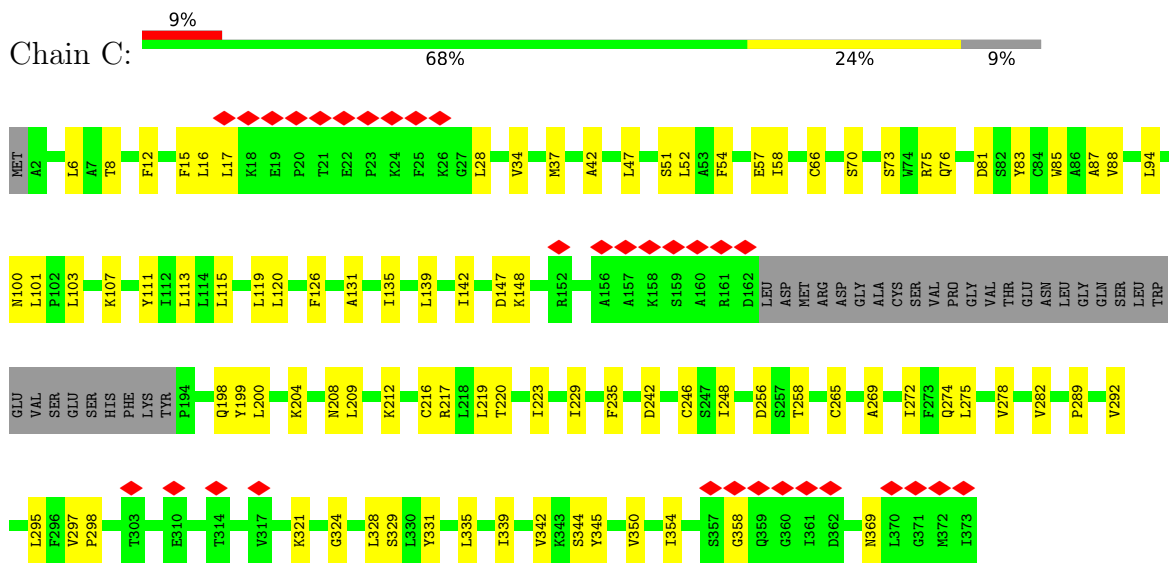

• Molecule 1: Pannexin-1

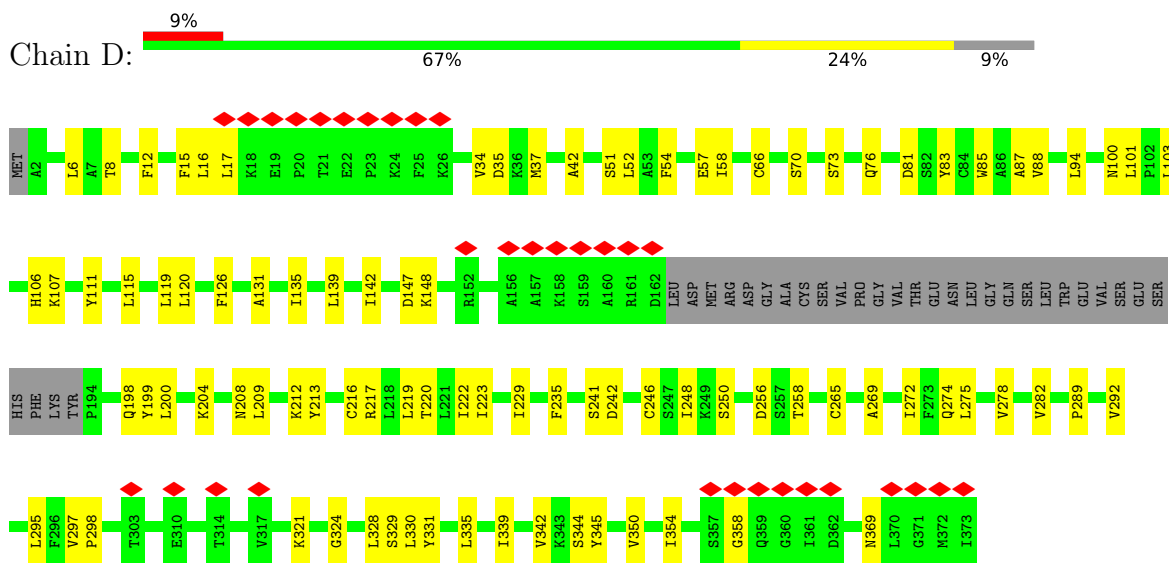

• Molecule 1: Pannexin-1

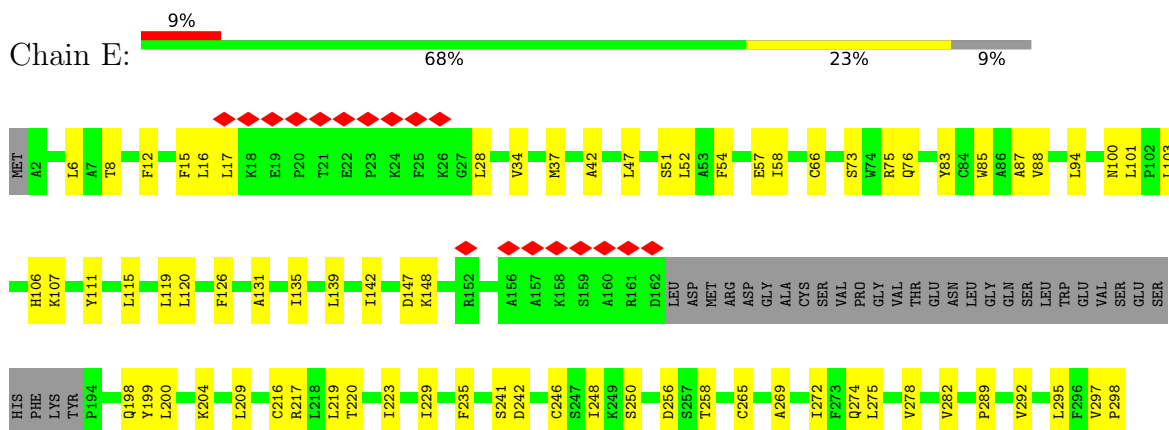



• Molecule 1: Pannexin-1

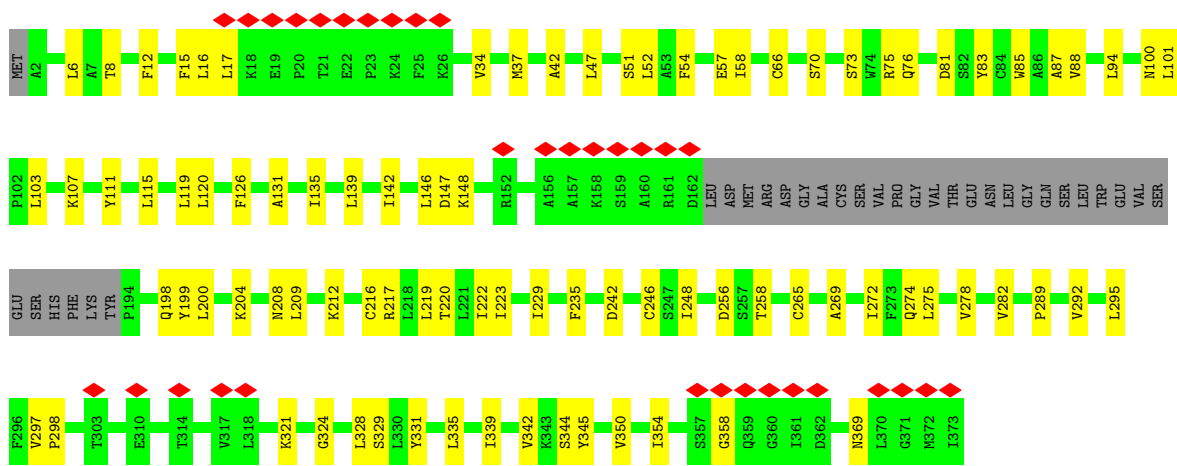

• Molecule 1: Pannexin-1

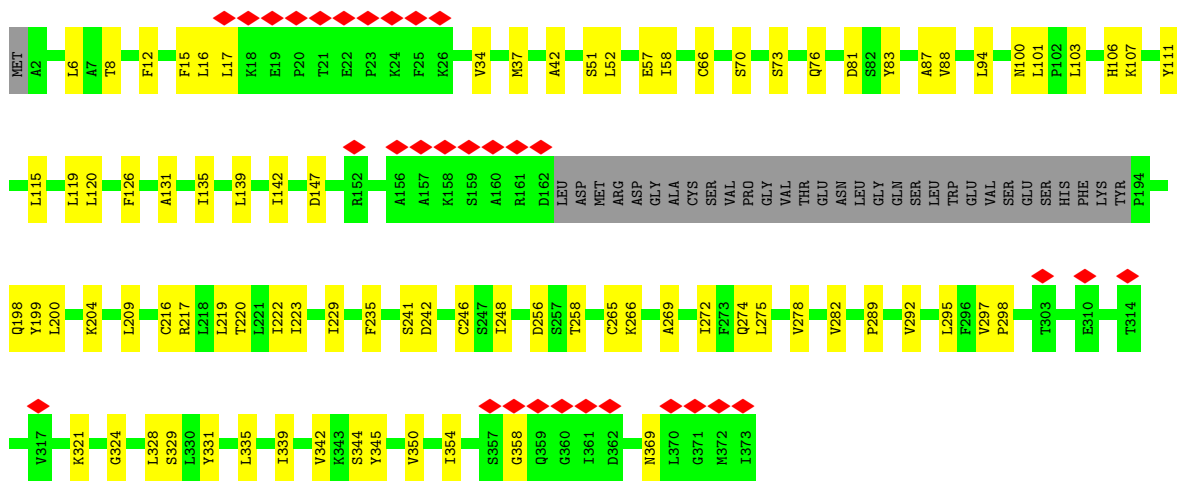

4 Experimental information

Property	Value	Source
EM reconstruction method	SINGLE PARTICLE	Depositor
Imposed symmetry	POINT, Not provided	
Number of particles used	407341	Depositor
Resolution determination method	FSC 0.143 CUT-OFF	Depositor
CTF correction method	PHASE FLIPPING AND AMPLITUDE CORRECTION	Depositor
Microscope	FEI TITAN KRIOS	Depositor
Voltage (kV)	300	Depositor
Electron dose ($e^-/\text{\AA}^2$)	49.6	Depositor
Minimum defocus (nm)	Not provided	
Maximum defocus (nm)	Not provided	
Magnification	Not provided	
Image detector	GATAN K2 SUMMIT (4k x 4k)	Depositor
Maximum map value	0.034	Depositor
Minimum map value	-0.009	Depositor
Average map value	0.000	Depositor
Map value standard deviation	0.002	Depositor
Recommended contour level	0.0075	Depositor
Map size (\AA)	243.59999, 243.59999, 243.59999	wwPDB
Map dimensions	300, 300, 300	wwPDB
Map angles ($^\circ$)	90.0, 90.0, 90.0	wwPDB
Pixel spacing (\AA)	0.812, 0.812, 0.812	Depositor

5 Model quality [i](#)

5.1 Standard geometry [i](#)

Bond lengths and bond angles in the following residue types are not validated in this section: CLR, PTY, DGA, 3PE

The Z score for a bond length (or angle) is the number of standard deviations the observed value is removed from the expected value. A bond length (or angle) with $|Z| > 5$ is considered an outlier worth inspection. RMSZ is the root-mean-square of all Z scores of the bond lengths (or angles).

Mol	Chain	Bond lengths		Bond angles	
		RMSZ	# Z >5	RMSZ	# Z >5
1	A	0.35	0/2597	0.43	0/3547
1	B	0.35	0/2597	0.43	0/3547
1	C	0.35	0/2597	0.42	0/3547
1	D	0.35	0/2597	0.43	0/3547
1	E	0.35	0/2597	0.43	0/3547
1	F	0.35	0/2597	0.43	0/3547
1	G	0.35	0/2597	0.43	0/3547
All	All	0.35	0/18179	0.43	0/24829

There are no bond length outliers.

There are no bond angle outliers.

There are no chirality outliers.

There are no planarity outliers.

5.2 Too-close contacts [i](#)

In the following table, the Non-H and H(model) columns list the number of non-hydrogen atoms and hydrogen atoms in the chain respectively. The H(added) column lists the number of hydrogen atoms added and optimized by MolProbity. The Clashes column lists the number of clashes within the asymmetric unit, whereas Symm-Clashes lists symmetry-related clashes.

Mol	Chain	Non-H	H(model)	H(added)	Clashes	Symm-Clashes
1	A	2539	0	2466	70	0
1	B	2539	0	2466	75	0
1	C	2539	0	2466	83	0
1	D	2539	0	2466	81	0
1	E	2539	0	2466	79	0
1	F	2539	0	2466	81	0

Continued on next page...

Continued from previous page...

Mol	Chain	Non-H	H(model)	H(added)	Clashes	Symm-Clashes
1	G	2539	0	2466	76	0
2	A	81	0	111	14	0
2	B	81	0	111	14	0
2	C	81	0	111	14	0
2	D	81	0	111	14	0
2	E	81	0	111	14	0
2	F	81	0	111	14	0
2	G	81	0	111	13	0
3	A	42	0	61	5	0
3	B	42	0	61	5	0
3	C	42	0	61	5	0
3	D	42	0	61	5	0
3	E	42	0	61	5	0
3	F	42	0	61	5	0
3	G	42	0	61	5	0
4	A	50	0	64	4	0
4	B	25	0	32	1	0
4	C	25	0	32	2	0
4	D	25	0	32	2	0
4	E	25	0	32	2	0
4	F	25	0	32	2	0
5	A	56	0	92	6	0
5	B	56	0	92	6	0
5	C	56	0	92	6	0
5	D	56	0	92	6	0
5	E	56	0	92	5	0
5	F	56	0	92	6	0
5	G	56	0	92	6	0
All	All	19201	0	19334	583	0

The all-atom clashscore is defined as the number of clashes found per 1000 atoms (including hydrogen atoms). The all-atom clashscore for this structure is 15.

All (583) close contacts within the same asymmetric unit are listed below, sorted by their clash magnitude.

Atom-1	Atom-2	Interatomic distance (Å)	Clash overlap (Å)
1:C:87:ALA:O	1:C:94:LEU:HD23	1.68	0.93
2:F:401:PTY:H131	5:F:404:CLR:H112	1.50	0.93
2:G:401:PTY:H131	5:G:404:CLR:H112	1.50	0.93
1:F:87:ALA:O	1:F:94:LEU:HD23	1.68	0.92
2:C:401:PTY:H131	5:C:404:CLR:H112	1.50	0.92

Continued on next page...

Continued from previous page...

Atom-1	Atom-2	Interatomic distance (Å)	Clash overlap (Å)
1:E:87:ALA:O	1:E:94:LEU:HD23	1.68	0.92
2:D:401:PTY:H131	5:D:404:CLR:H112	1.50	0.92
1:G:87:ALA:O	1:G:94:LEU:HD23	1.68	0.92
2:B:401:PTY:H131	5:B:404:CLR:H112	1.50	0.92
1:D:87:ALA:O	1:D:94:LEU:HD23	1.68	0.91
2:E:401:PTY:H131	5:E:404:CLR:H112	1.50	0.91
2:A:401:PTY:H131	5:A:405:CLR:H112	1.50	0.91
1:A:87:ALA:O	1:A:94:LEU:HD23	1.68	0.91
1:B:87:ALA:O	1:B:94:LEU:HD23	1.68	0.91
1:E:131:ALA:HB1	1:E:209:LEU:HD11	1.55	0.88
1:B:131:ALA:HB1	1:B:209:LEU:HD11	1.55	0.88
1:D:131:ALA:HB1	1:D:209:LEU:HD11	1.55	0.87
1:C:131:ALA:HB1	1:C:209:LEU:HD11	1.54	0.87
1:F:131:ALA:HB1	1:F:209:LEU:HD11	1.55	0.87
1:A:131:ALA:HB1	1:A:209:LEU:HD11	1.55	0.87
1:G:131:ALA:HB1	1:G:209:LEU:HD11	1.55	0.86
1:G:73:SER:H	1:G:76:GLN:HE21	1.28	0.81
1:B:73:SER:H	1:B:76:GLN:HE21	1.28	0.80
1:A:73:SER:H	1:A:76:GLN:HE21	1.28	0.80
1:E:73:SER:H	1:E:76:GLN:HE21	1.28	0.79
1:D:73:SER:H	1:D:76:GLN:HE21	1.28	0.78
1:C:73:SER:H	1:C:76:GLN:HE21	1.28	0.78
1:F:73:SER:H	1:F:76:GLN:HE21	1.28	0.78
1:G:335:LEU:O	1:G:339:ILE:HB	1.86	0.76
1:B:335:LEU:O	1:B:339:ILE:HB	1.86	0.76
1:F:335:LEU:O	1:F:339:ILE:HB	1.86	0.75
1:D:335:LEU:O	1:D:339:ILE:HB	1.86	0.74
1:E:335:LEU:O	1:E:339:ILE:HB	1.86	0.74
1:C:335:LEU:O	1:C:339:ILE:HB	1.86	0.74
1:A:335:LEU:O	1:A:339:ILE:HB	1.86	0.74
2:B:401:PTY:H131	5:B:404:CLR:C11	2.18	0.74
2:C:401:PTY:H131	5:C:404:CLR:C11	2.18	0.74
2:A:401:PTY:H131	5:A:405:CLR:C11	2.18	0.73
2:D:401:PTY:H131	5:D:404:CLR:C11	2.18	0.73
1:A:88:VAL:HA	1:A:94:LEU:CD2	2.19	0.73
1:C:88:VAL:HA	1:C:94:LEU:CD2	2.19	0.73
1:B:88:VAL:HA	1:B:94:LEU:CD2	2.19	0.72
1:G:88:VAL:HA	1:G:94:LEU:CD2	2.19	0.72
1:F:88:VAL:HA	1:F:94:LEU:CD2	2.19	0.72
2:G:401:PTY:H131	5:G:404:CLR:C11	2.18	0.72
1:D:88:VAL:HA	1:D:94:LEU:CD2	2.19	0.72

Continued on next page...

Continued from previous page...

Atom-1	Atom-2	Interatomic distance (Å)	Clash overlap (Å)
1:G:131:ALA:HB1	1:G:209:LEU:CD1	2.20	0.72
1:C:131:ALA:HB1	1:C:209:LEU:CD1	2.20	0.71
1:E:88:VAL:HA	1:E:94:LEU:CD2	2.19	0.71
2:F:401:PTY:H131	5:F:404:CLR:C11	2.18	0.71
1:A:131:ALA:HB1	1:A:209:LEU:CD1	2.20	0.71
1:B:131:ALA:HB1	1:B:209:LEU:CD1	2.20	0.71
1:D:131:ALA:HB1	1:D:209:LEU:CD1	2.20	0.71
2:E:401:PTY:H131	5:E:404:CLR:C11	2.18	0.71
1:F:131:ALA:HB1	1:F:209:LEU:CD1	2.20	0.71
1:F:321:LYS:HA	1:F:328:LEU:HD21	1.73	0.70
1:E:321:LYS:HA	1:E:328:LEU:HD21	1.72	0.70
1:E:131:ALA:HB1	1:E:209:LEU:CD1	2.20	0.70
1:A:321:LYS:HA	1:A:328:LEU:HD21	1.72	0.70
1:G:321:LYS:HA	1:G:328:LEU:HD21	1.72	0.70
1:A:75:ARG:NH1	1:B:81:ASP:OD2	2.25	0.69
1:B:321:LYS:HA	1:B:328:LEU:HD21	1.72	0.69
1:D:321:LYS:HA	1:D:328:LEU:HD21	1.72	0.69
1:C:321:LYS:HA	1:C:328:LEU:HD21	1.72	0.69
1:A:42:ALA:HB1	1:A:120:LEU:HD13	1.75	0.69
1:G:42:ALA:HB1	1:G:120:LEU:HD13	1.75	0.69
1:F:42:ALA:HB1	1:F:120:LEU:HD13	1.75	0.68
1:B:42:ALA:HB1	1:B:120:LEU:HD13	1.75	0.67
1:D:42:ALA:HB1	1:D:120:LEU:HD13	1.75	0.66
1:C:42:ALA:HB1	1:C:120:LEU:HD13	1.75	0.66
1:E:42:ALA:HB1	1:E:120:LEU:HD13	1.75	0.66
1:F:101:LEU:HD12	2:F:401:PTY:H111	1.79	0.65
1:E:101:LEU:HD12	2:E:401:PTY:H111	1.79	0.65
1:D:101:LEU:HD12	2:D:401:PTY:H111	1.79	0.64
1:G:101:LEU:HD12	2:G:401:PTY:H111	1.79	0.64
1:C:101:LEU:HD12	2:C:401:PTY:H111	1.79	0.64
1:B:101:LEU:HD12	2:B:401:PTY:H111	1.79	0.64
2:D:402:PTY:HC12	2:D:402:PTY:H132	1.80	0.64
2:E:402:PTY:H132	2:E:402:PTY:HC12	1.80	0.64
1:A:88:VAL:HG21	1:A:107:LYS:HD2	1.81	0.63
1:A:101:LEU:HD12	2:A:401:PTY:H111	1.79	0.63
2:F:402:PTY:HC12	2:F:402:PTY:H132	1.80	0.63
1:G:88:VAL:HG21	1:G:107:LYS:HD2	1.81	0.63
2:G:402:PTY:H132	2:G:402:PTY:HC12	1.80	0.63
1:B:88:VAL:HG21	1:B:107:LYS:HD2	1.81	0.63
1:C:88:VAL:HG21	1:C:107:LYS:HD2	1.81	0.63
2:C:402:PTY:HC12	2:C:402:PTY:H132	1.80	0.63

Continued on next page...

Continued from previous page...

Atom-1	Atom-2	Interatomic distance (Å)	Clash overlap (Å)
1:D:88:VAL:HG21	1:D:107:LYS:HD2	1.81	0.63
1:E:88:VAL:HG21	1:E:107:LYS:HD2	1.80	0.63
1:F:88:VAL:HG21	1:F:107:LYS:HD2	1.81	0.63
2:A:402:PTY:HC12	2:A:402:PTY:H132	1.80	0.62
2:B:402:PTY:H132	2:B:402:PTY:HC12	1.80	0.62
1:G:354:ILE:O	1:G:358:GLY:N	2.30	0.62
1:B:354:ILE:O	1:B:358:GLY:N	2.30	0.61
1:A:275:LEU:O	1:A:278:VAL:HG12	2.01	0.61
1:G:147:ASP:OD1	1:G:344:SER:HB3	2.01	0.61
1:B:275:LEU:O	1:B:278:VAL:HG12	2.01	0.61
1:E:142:ILE:HD13	1:E:200:LEU:HD21	1.83	0.61
1:F:147:ASP:OD1	1:F:344:SER:HB3	2.01	0.61
1:C:275:LEU:O	1:C:278:VAL:HG12	2.01	0.61
1:D:142:ILE:HD13	1:D:200:LEU:HD21	1.83	0.61
1:G:142:ILE:HD13	1:G:200:LEU:HD21	1.83	0.61
1:A:147:ASP:OD1	1:A:344:SER:HB3	2.01	0.60
1:F:142:ILE:HD13	1:F:200:LEU:HD21	1.83	0.60
1:G:275:LEU:O	1:G:278:VAL:HG12	2.01	0.60
1:D:275:LEU:O	1:D:278:VAL:HG12	2.01	0.60
1:F:354:ILE:O	1:F:358:GLY:N	2.30	0.60
1:A:142:ILE:HD13	1:A:200:LEU:HD21	1.83	0.60
1:A:354:ILE:O	1:A:358:GLY:N	2.30	0.60
1:B:147:ASP:OD1	1:B:344:SER:HB3	2.00	0.60
1:C:147:ASP:OD1	1:C:344:SER:HB3	2.00	0.60
1:B:278:VAL:O	1:B:282:VAL:HG23	2.01	0.60
1:D:147:ASP:OD1	1:D:344:SER:HB3	2.01	0.60
1:E:275:LEU:O	1:E:278:VAL:HG12	2.01	0.60
1:E:147:ASP:OD1	1:E:344:SER:HB3	2.00	0.60
1:C:142:ILE:HD13	1:C:200:LEU:HD21	1.83	0.59
1:F:278:VAL:O	1:F:282:VAL:HG23	2.01	0.59
1:F:275:LEU:O	1:F:278:VAL:HG12	2.01	0.59
1:G:278:VAL:O	1:G:282:VAL:HG23	2.01	0.59
1:B:115:LEU:HB2	2:B:401:PTY:H431	1.84	0.59
1:B:142:ILE:HD13	1:B:200:LEU:HD21	1.83	0.59
1:D:278:VAL:O	1:D:282:VAL:HG23	2.01	0.59
1:E:278:VAL:O	1:E:282:VAL:HG23	2.01	0.59
1:F:111:TYR:OH	1:G:52:LEU:O	2.20	0.59
1:A:278:VAL:O	1:A:282:VAL:HG23	2.01	0.59
1:C:111:TYR:OH	1:D:52:LEU:O	2.19	0.59
1:C:115:LEU:HB2	2:C:401:PTY:H431	1.84	0.59
1:C:278:VAL:O	1:C:282:VAL:HG23	2.01	0.59

Continued on next page...

Continued from previous page...

Atom-1	Atom-2	Interatomic distance (Å)	Clash overlap (Å)
1:B:111:TYR:OH	1:C:52:LEU:O	2.20	0.59
1:A:350:VAL:O	1:A:354:ILE:HG12	2.03	0.59
1:F:350:VAL:O	1:F:354:ILE:HG12	2.03	0.59
1:A:115:LEU:HB2	2:A:401:PTY:H431	1.84	0.58
1:C:354:ILE:O	1:C:358:GLY:N	2.31	0.58
2:D:401:PTY:O13	2:D:401:PTY:N1	2.37	0.58
1:D:115:LEU:HB2	2:D:401:PTY:H431	1.84	0.58
2:A:401:PTY:O13	2:A:401:PTY:N1	2.37	0.58
2:F:401:PTY:O13	2:F:401:PTY:N1	2.36	0.58
1:C:350:VAL:O	1:C:354:ILE:HG12	2.03	0.58
2:C:401:PTY:N1	2:C:401:PTY:O13	2.37	0.58
2:B:401:PTY:O13	2:B:401:PTY:N1	2.37	0.58
1:D:350:VAL:O	1:D:354:ILE:HG12	2.03	0.58
2:E:401:PTY:N1	2:E:401:PTY:O13	2.36	0.58
1:C:66:CYS:HA	1:C:265:CYS:HA	1.86	0.58
1:D:66:CYS:HA	1:D:265:CYS:HA	1.86	0.58
1:A:66:CYS:HA	1:A:265:CYS:HA	1.86	0.58
1:B:66:CYS:HA	1:B:265:CYS:HA	1.86	0.58
1:G:350:VAL:O	1:G:354:ILE:HG12	2.03	0.58
2:G:401:PTY:O13	2:G:401:PTY:N1	2.36	0.58
1:G:66:CYS:HA	1:G:265:CYS:HA	1.86	0.57
1:F:115:LEU:HB2	2:F:401:PTY:H431	1.84	0.57
1:B:350:VAL:O	1:B:354:ILE:HG12	2.03	0.57
1:E:66:CYS:HA	1:E:265:CYS:HA	1.86	0.57
1:E:115:LEU:HB2	2:E:401:PTY:H431	1.84	0.57
1:E:350:VAL:O	1:E:354:ILE:HG12	2.03	0.57
1:F:66:CYS:HA	1:F:265:CYS:HA	1.86	0.57
1:A:54:PHE:CD2	1:B:57:GLU:HG2	2.39	0.57
1:E:354:ILE:O	1:E:358:GLY:N	2.30	0.57
1:G:115:LEU:HB2	2:G:401:PTY:H431	1.84	0.57
1:E:111:TYR:OH	1:F:52:LEU:O	2.23	0.57
5:D:405:CLR:H211	5:D:405:CLR:H241	1.86	0.57
5:C:405:CLR:H211	5:C:405:CLR:H241	1.86	0.57
5:E:405:CLR:H211	5:E:405:CLR:H241	1.86	0.57
1:A:256:ASP:OD1	1:A:258:THR:HG22	2.06	0.56
1:E:54:PHE:CD2	1:F:57:GLU:HG2	2.41	0.56
1:B:256:ASP:OD1	1:B:258:THR:HG22	2.06	0.56
5:B:405:CLR:H211	5:B:405:CLR:H241	1.86	0.56
1:F:256:ASP:OD1	1:F:258:THR:HG22	2.06	0.56
1:G:256:ASP:OD1	1:G:258:THR:HG22	2.06	0.56
3:A:403:3PE:H3C1	1:G:219:LEU:HD22	1.87	0.56

Continued on next page...

Continued from previous page...

Atom-1	Atom-2	Interatomic distance (Å)	Clash overlap (Å)
1:D:111:TYR:OH	1:E:52:LEU:O	2.24	0.56
5:A:406:CLR:H211	5:A:406:CLR:H241	1.87	0.56
5:F:405:CLR:H211	5:F:405:CLR:H241	1.87	0.56
1:A:87:ALA:O	1:A:94:LEU:CD2	2.50	0.55
1:A:126:PHE:CZ	3:B:403:3PE:H3F2	2.42	0.55
1:E:256:ASP:OD1	1:E:258:THR:HG22	2.06	0.55
1:C:256:ASP:OD1	1:C:258:THR:HG22	2.06	0.55
5:G:405:CLR:H211	5:G:405:CLR:H241	1.86	0.55
1:A:54:PHE:CG	1:B:57:GLU:HG2	2.41	0.55
1:D:256:ASP:OD1	1:D:258:THR:HG22	2.06	0.55
1:G:73:SER:OG	1:G:76:GLN:HG3	2.07	0.55
1:F:73:SER:OG	1:F:76:GLN:HG3	2.07	0.54
1:A:73:SER:OG	1:A:76:GLN:HG3	2.07	0.54
1:F:229:ILE:HA	5:F:405:CLR:H213	1.90	0.54
1:A:229:ILE:HA	5:A:406:CLR:H213	1.90	0.54
1:C:73:SER:OG	1:C:76:GLN:HG3	2.07	0.54
1:E:229:ILE:HA	5:E:405:CLR:H213	1.90	0.54
1:G:229:ILE:HA	5:G:405:CLR:H213	1.90	0.54
1:A:119:LEU:HB3	1:A:223:ILE:HD13	1.90	0.54
1:B:87:ALA:O	1:B:94:LEU:CD2	2.50	0.54
1:B:119:LEU:HB3	1:B:223:ILE:HD13	1.89	0.54
1:C:119:LEU:HB3	1:C:223:ILE:HD13	1.90	0.54
1:D:229:ILE:HA	5:D:405:CLR:H213	1.90	0.54
1:B:73:SER:OG	1:B:76:GLN:HG3	2.07	0.54
1:F:219:LEU:HD22	3:G:403:3PE:H3C1	1.90	0.54
1:E:73:SER:OG	1:E:76:GLN:HG3	2.07	0.54
1:F:54:PHE:CD2	1:G:57:GLU:HG2	2.43	0.54
1:D:354:ILE:O	1:D:358:GLY:N	2.30	0.54
1:D:73:SER:OG	1:D:76:GLN:HG3	2.07	0.54
1:D:119:LEU:HB3	1:D:223:ILE:HD13	1.89	0.54
1:A:83:TYR:CD1	1:A:248:ILE:HG22	2.43	0.54
1:D:83:TYR:CD1	1:D:248:ILE:HG22	2.43	0.53
1:G:119:LEU:HB3	1:G:223:ILE:HD13	1.89	0.53
1:B:229:ILE:HA	5:B:405:CLR:H213	1.90	0.53
1:C:229:ILE:HA	5:C:405:CLR:H213	1.90	0.53
1:E:83:TYR:CD1	1:E:248:ILE:HG22	2.43	0.53
1:G:242:ASP:OD1	1:G:242:ASP:N	2.39	0.53
1:C:83:TYR:CD1	1:C:248:ILE:HG22	2.43	0.53
1:D:126:PHE:HB2	3:E:403:3PE:H391	1.90	0.53
1:E:119:LEU:HB3	1:E:223:ILE:HD13	1.89	0.53
1:C:87:ALA:O	1:C:94:LEU:CD2	2.50	0.53

Continued on next page...

Continued from previous page...

Atom-1	Atom-2	Interatomic distance (Å)	Clash overlap (Å)
1:D:219:LEU:HD22	3:E:403:3PE:H3C1	1.90	0.53
1:E:135:ILE:HB	1:E:209:LEU:HD21	1.90	0.53
1:F:119:LEU:HB3	1:F:223:ILE:HD13	1.90	0.53
1:G:83:TYR:CD1	1:G:248:ILE:HG22	2.43	0.53
1:E:101:LEU:CD1	2:E:401:PTY:H111	2.39	0.53
1:B:83:TYR:CD1	1:B:248:ILE:HG22	2.43	0.53
1:D:87:ALA:O	1:D:94:LEU:CD2	2.50	0.53
1:D:101:LEU:CD1	2:D:401:PTY:H111	2.39	0.53
1:D:135:ILE:HB	1:D:209:LEU:HD21	1.90	0.53
1:F:101:LEU:CD1	2:F:401:PTY:H111	2.39	0.53
1:F:135:ILE:HB	1:F:209:LEU:HD21	1.90	0.53
1:A:58:ILE:HG13	1:G:111:TYR:CZ	2.43	0.53
1:A:135:ILE:HB	1:A:209:LEU:HD21	1.90	0.53
1:B:219:LEU:HD22	3:C:403:3PE:H3C1	1.90	0.53
1:C:101:LEU:CD1	2:C:401:PTY:H111	2.39	0.53
1:B:101:LEU:CD1	2:B:401:PTY:H111	2.39	0.52
1:C:219:LEU:HD22	3:D:403:3PE:H3C1	1.89	0.52
1:B:135:ILE:HB	1:B:209:LEU:HD21	1.90	0.52
1:C:54:PHE:CD2	1:D:57:GLU:HG2	2.43	0.52
1:C:135:ILE:HB	1:C:209:LEU:HD21	1.90	0.52
1:F:83:TYR:CD1	1:F:248:ILE:HG22	2.43	0.52
1:F:242:ASP:OD1	1:F:242:ASP:N	2.39	0.52
1:G:101:LEU:CD1	2:G:401:PTY:H111	2.39	0.52
1:B:54:PHE:CD2	1:C:57:GLU:HG2	2.44	0.52
3:D:403:3PE:H111	3:D:403:3PE:H11	1.92	0.52
1:E:87:ALA:O	1:E:94:LEU:CD2	2.50	0.52
1:G:135:ILE:HB	1:G:209:LEU:HD21	1.90	0.52
3:E:403:3PE:H111	3:E:403:3PE:H11	1.92	0.52
3:F:403:3PE:H111	3:F:403:3PE:H11	1.92	0.52
1:A:289:PRO:HA	1:A:292:VAL:HG12	1.92	0.52
3:A:403:3PE:H111	3:A:403:3PE:H11	1.92	0.52
3:A:403:3PE:H391	1:G:126:PHE:HB2	1.92	0.52
2:D:401:PTY:O10	2:D:401:PTY:HC12	2.11	0.52
2:F:401:PTY:O10	2:F:401:PTY:HC12	2.10	0.52
1:E:126:PHE:HB2	3:F:403:3PE:H391	1.92	0.51
1:G:289:PRO:HA	1:G:292:VAL:HG12	1.92	0.51
1:A:101:LEU:CD1	2:A:401:PTY:H111	2.39	0.51
1:B:289:PRO:HA	1:B:292:VAL:HG12	1.92	0.51
3:B:403:3PE:H111	3:B:403:3PE:H11	1.92	0.51
3:C:403:3PE:H11	3:C:403:3PE:H111	1.92	0.51
1:F:289:PRO:HA	1:F:292:VAL:HG12	1.92	0.51

Continued on next page...

Continued from previous page...

Atom-1	Atom-2	Interatomic distance (Å)	Clash overlap (Å)
4:F:406:DGA:HA61	1:G:17:LEU:HD21	1.93	0.51
2:G:401:PTY:O10	2:G:401:PTY:HC12	2.10	0.51
1:F:87:ALA:O	1:F:94:LEU:CD2	2.50	0.51
2:C:401:PTY:O10	2:C:401:PTY:HC12	2.10	0.51
1:E:289:PRO:HA	1:E:292:VAL:HG12	1.92	0.51
4:E:406:DGA:HA61	1:F:17:LEU:HD21	1.93	0.51
1:A:17:LEU:HD21	4:A:404:DGA:HA61	1.93	0.51
4:D:406:DGA:HA61	1:E:17:LEU:HD21	1.93	0.51
3:A:403:3PE:H3C1	1:G:219:LEU:CD2	2.40	0.51
1:C:289:PRO:HA	1:C:292:VAL:HG12	1.92	0.51
4:A:407:DGA:HA61	1:B:17:LEU:HD21	1.93	0.50
1:B:94:LEU:O	1:B:94:LEU:HD12	2.12	0.50
1:B:126:PHE:HB2	3:C:403:3PE:H391	1.93	0.50
1:D:289:PRO:HA	1:D:292:VAL:HG12	1.92	0.50
3:G:403:3PE:H111	3:G:403:3PE:H11	1.92	0.50
1:C:126:PHE:HB2	3:D:403:3PE:H391	1.94	0.50
1:E:106:HIS:HE2	1:E:241:SER:HG	1.56	0.50
1:E:242:ASP:OD1	1:E:242:ASP:N	2.39	0.50
2:E:401:PTY:HC12	2:E:401:PTY:O10	2.10	0.50
1:F:126:PHE:HB2	3:G:403:3PE:H391	1.94	0.50
4:C:406:DGA:HA61	1:D:17:LEU:HD21	1.93	0.50
1:D:94:LEU:HD12	1:D:94:LEU:O	2.12	0.50
1:F:94:LEU:HD12	1:F:94:LEU:O	2.12	0.50
1:A:126:PHE:HB2	3:B:403:3PE:H391	1.94	0.50
1:E:94:LEU:HD12	1:E:94:LEU:O	2.12	0.50
4:B:406:DGA:HA61	1:C:17:LEU:HD21	1.93	0.50
1:C:111:TYR:CZ	1:D:58:ILE:HG13	2.47	0.50
1:C:8:THR:HA	1:C:12:PHE:HD2	1.77	0.50
1:D:106:HIS:HE2	1:D:241:SER:HG	1.56	0.50
1:E:219:LEU:HD22	3:F:403:3PE:H3C1	1.94	0.50
2:A:401:PTY:O10	2:A:401:PTY:HC12	2.11	0.49
2:B:401:PTY:O10	2:B:401:PTY:HC12	2.10	0.49
1:G:87:ALA:O	1:G:94:LEU:CD2	2.50	0.49
1:A:94:LEU:HD12	1:A:94:LEU:O	2.12	0.49
1:C:219:LEU:CD2	3:D:403:3PE:H3C1	2.42	0.49
1:B:8:THR:HA	1:B:12:PHE:HD2	1.77	0.49
1:C:94:LEU:HD12	1:C:94:LEU:O	2.12	0.49
2:C:402:PTY:HC12	2:C:402:PTY:C11	2.43	0.49
1:E:135:ILE:HG13	1:E:331:TYR:CE1	2.48	0.49
1:G:8:THR:HA	1:G:12:PHE:HD2	1.77	0.49
1:B:111:TYR:CZ	1:C:58:ILE:HG13	2.47	0.49

Continued on next page...

Continued from previous page...

Atom-1	Atom-2	Interatomic distance (Å)	Clash overlap (Å)
1:B:83:TYR:HH	1:B:250:SER:HG	1.53	0.49
1:A:52:LEU:O	1:G:111:TYR:OH	2.31	0.49
1:A:354:ILE:HD12	1:G:198:GLN:HB3	1.94	0.49
1:B:219:LEU:CD2	3:C:403:3PE:H3C1	2.43	0.49
1:C:135:ILE:HG13	1:C:331:TYR:CE1	2.48	0.49
1:E:148:LYS:NZ	1:F:369:ASN:O	2.46	0.49
1:G:135:ILE:HG13	1:G:331:TYR:CE1	2.48	0.49
2:B:402:PTY:HC12	2:B:402:PTY:C11	2.43	0.49
1:C:242:ASP:OD1	1:C:242:ASP:N	2.39	0.49
1:D:8:THR:HA	1:D:12:PHE:HD2	1.77	0.49
1:D:111:TYR:CZ	1:E:58:ILE:HG13	2.47	0.49
1:G:94:LEU:O	1:G:94:LEU:HD12	2.11	0.49
1:E:111:TYR:CZ	1:F:58:ILE:HG13	2.48	0.49
2:E:402:PTY:HC12	2:E:402:PTY:C11	2.43	0.49
1:F:111:TYR:CZ	1:G:58:ILE:HG13	2.47	0.49
1:B:274:GLN:NE2	2:B:402:PTY:O13	2.45	0.49
1:D:135:ILE:HG13	1:D:331:TYR:CE1	2.48	0.49
1:F:219:LEU:CD2	3:G:403:3PE:H3C1	2.43	0.49
1:A:135:ILE:HG13	1:A:331:TYR:CE1	2.48	0.48
1:B:135:ILE:HG13	1:B:331:TYR:CE1	2.48	0.48
1:D:242:ASP:OD1	1:D:242:ASP:N	2.39	0.48
1:G:106:HIS:HE2	1:G:241:SER:HG	1.56	0.48
1:D:219:LEU:CD2	3:E:403:3PE:H3C1	2.42	0.48
1:E:8:THR:HA	1:E:12:PHE:HD2	1.77	0.48
1:A:274:GLN:NE2	2:A:402:PTY:O13	2.45	0.48
1:F:135:ILE:HG13	1:F:331:TYR:CE1	2.48	0.48
1:F:198:GLN:HB3	1:G:354:ILE:HD12	1.95	0.48
2:A:402:PTY:HC12	2:A:402:PTY:C13	2.43	0.48
2:B:402:PTY:HC12	2:B:402:PTY:C13	2.43	0.48
2:C:402:PTY:HC12	2:C:402:PTY:C13	2.43	0.48
2:G:402:PTY:HC12	2:G:402:PTY:C11	2.43	0.48
1:D:54:PHE:CD2	1:E:57:GLU:HG2	2.49	0.48
1:F:8:THR:HA	1:F:12:PHE:HD2	1.77	0.48
1:A:8:THR:HA	1:A:12:PHE:HD2	1.77	0.48
2:D:402:PTY:HC12	2:D:402:PTY:C13	2.43	0.48
2:D:402:PTY:HC12	2:D:402:PTY:C11	2.43	0.48
3:E:403:3PE:H221	3:E:403:3PE:H2	1.50	0.48
3:G:403:3PE:H221	3:G:403:3PE:H2	1.50	0.48
1:C:198:GLN:HB3	1:D:354:ILE:HD12	1.95	0.48
1:D:274:GLN:NE2	2:D:402:PTY:O13	2.45	0.48
1:E:75:ARG:NH1	1:F:81:ASP:OD2	2.46	0.48

Continued on next page...

Continued from previous page...

Atom-1	Atom-2	Interatomic distance (Å)	Clash overlap (Å)
1:B:198:GLN:HB3	1:C:354:ILE:HD12	1.95	0.48
1:D:100:ASN:HA	1:D:103:LEU:HD12	1.96	0.47
1:E:54:PHE:CG	1:F:57:GLU:HG2	2.49	0.47
1:E:100:ASN:HA	1:E:103:LEU:HD12	1.96	0.47
1:A:47:LEU:HD11	1:B:12:PHE:CE2	2.49	0.47
5:B:404:CLR:H222	5:B:404:CLR:H162	1.58	0.47
1:C:100:ASN:HA	1:C:103:LEU:HD12	1.96	0.47
1:C:148:LYS:NZ	1:D:369:ASN:O	2.48	0.47
1:E:94:LEU:HD12	1:E:94:LEU:C	2.35	0.47
2:E:402:PTY:HC12	2:E:402:PTY:C13	2.43	0.47
1:F:94:LEU:HD12	1:F:94:LEU:C	2.35	0.47
2:F:402:PTY:HC12	2:F:402:PTY:C11	2.43	0.47
2:A:402:PTY:HC12	2:A:402:PTY:C11	2.43	0.47
1:B:148:LYS:NZ	1:C:369:ASN:O	2.48	0.47
1:C:94:LEU:HD12	1:C:94:LEU:C	2.35	0.47
1:F:100:ASN:HA	1:F:103:LEU:HD12	1.96	0.47
1:F:148:LYS:NZ	1:G:369:ASN:O	2.47	0.47
1:G:94:LEU:HD12	1:G:94:LEU:C	2.35	0.47
5:A:405:CLR:H162	5:A:405:CLR:H222	1.58	0.47
1:B:100:ASN:HA	1:B:103:LEU:HD12	1.96	0.47
1:D:94:LEU:HD12	1:D:94:LEU:C	2.35	0.47
1:A:94:LEU:HD12	1:A:94:LEU:C	2.35	0.47
1:B:88:VAL:HA	1:B:94:LEU:HD22	1.97	0.47
3:D:403:3PE:H2	3:D:403:3PE:H221	1.50	0.47
1:E:274:GLN:NE2	2:E:402:PTY:O13	2.45	0.47
5:F:404:CLR:H222	5:F:404:CLR:H162	1.58	0.47
1:G:274:GLN:NE2	2:G:402:PTY:O13	2.45	0.47
1:B:94:LEU:HD12	1:B:94:LEU:C	2.35	0.47
1:D:88:VAL:HA	1:D:94:LEU:HD22	1.97	0.47
5:G:404:CLR:H222	5:G:404:CLR:H162	1.58	0.47
1:G:100:ASN:HA	1:G:103:LEU:HD12	1.96	0.47
1:A:100:ASN:HA	1:A:103:LEU:HD12	1.96	0.47
2:F:402:PTY:HC12	2:F:402:PTY:C13	2.43	0.46
1:G:88:VAL:HA	1:G:94:LEU:HD22	1.97	0.46
4:E:406:DGA:HG12	4:E:406:DGA:HA22	1.45	0.46
4:A:404:DGA:HA22	4:A:404:DGA:HG12	1.45	0.46
1:C:269:ALA:HA	1:C:272:ILE:HD12	1.98	0.46
1:B:106:HIS:HE2	1:B:241:SER:HG	1.56	0.46
1:D:269:ALA:HA	1:D:272:ILE:HD12	1.98	0.46
1:C:274:GLN:NE2	2:C:402:PTY:O13	2.45	0.46
1:E:219:LEU:CD2	3:F:403:3PE:H3C1	2.46	0.46

Continued on next page...

Continued from previous page...

Atom-1	Atom-2	Interatomic distance (Å)	Clash overlap (Å)
1:B:269:ALA:HA	1:B:272:ILE:HD12	1.98	0.46
1:D:198:GLN:HB3	1:E:354:ILE:HD12	1.97	0.46
1:A:216:CYS:O	1:A:220:THR:HG23	2.17	0.45
4:F:406:DGA:HG12	4:F:406:DGA:HA22	1.45	0.45
2:G:402:PTY:HC12	2:G:402:PTY:C13	2.43	0.45
1:D:148:LYS:NZ	1:E:369:ASN:O	2.50	0.45
1:A:324:GLY:O	1:A:329:SER:OG	2.31	0.45
1:C:216:CYS:O	1:C:220:THR:HG23	2.17	0.45
1:E:269:ALA:HA	1:E:272:ILE:HD12	1.98	0.45
1:F:274:GLN:NE2	2:F:402:PTY:O13	2.45	0.45
1:D:6:LEU:HD13	1:D:51:SER:HB3	1.99	0.45
1:F:216:CYS:O	1:F:220:THR:HG23	2.17	0.45
1:F:297:VAL:HG23	1:F:298:PRO:HD3	1.99	0.45
4:D:406:DGA:HG12	4:D:406:DGA:HA22	1.45	0.45
1:E:6:LEU:HD13	1:E:51:SER:HB3	1.99	0.45
1:C:6:LEU:HD13	1:C:51:SER:HB3	1.99	0.45
1:D:83:TYR:HH	1:D:250:SER:HG	1.58	0.45
1:G:269:ALA:HA	1:G:272:ILE:HD12	1.98	0.45
1:G:297:VAL:HG23	1:G:298:PRO:HD3	1.99	0.45
1:A:269:ALA:HA	1:A:272:ILE:HD12	1.98	0.45
3:A:403:3PE:H2	3:A:403:3PE:H221	1.50	0.45
1:B:54:PHE:CG	1:C:57:GLU:HG2	2.52	0.45
1:B:216:CYS:O	1:B:220:THR:HG23	2.17	0.45
1:C:199:TYR:CD1	1:D:350:VAL:HG23	2.52	0.45
3:C:403:3PE:H2	3:C:403:3PE:H221	1.50	0.45
1:D:35:ASP:OD2	1:D:213:TYR:OH	2.26	0.45
1:E:297:VAL:HG23	1:E:298:PRO:HD3	1.99	0.45
1:F:269:ALA:HA	1:F:272:ILE:HD12	1.98	0.45
1:B:6:LEU:HD13	1:B:51:SER:HB3	1.99	0.44
1:A:88:VAL:HA	1:A:94:LEU:HD22	1.97	0.44
1:B:324:GLY:O	1:B:329:SER:OG	2.31	0.44
1:E:216:CYS:O	1:E:220:THR:HG23	2.17	0.44
1:F:6:LEU:HD13	1:F:51:SER:HB3	1.99	0.44
1:G:339:ILE:HD12	1:G:339:ILE:HA	1.85	0.44
1:C:54:PHE:CG	1:D:57:GLU:HG2	2.52	0.44
1:A:6:LEU:HD13	1:A:51:SER:HB3	1.99	0.44
1:B:297:VAL:HG23	1:B:298:PRO:HD3	1.99	0.44
1:C:297:VAL:HG23	1:C:298:PRO:HD3	1.99	0.44
1:G:235:PHE:HZ	2:G:402:PTY:H152	1.83	0.44
2:A:402:PTY:H141	2:A:402:PTY:H111	1.79	0.44
1:E:198:GLN:HB3	1:F:354:ILE:HD12	1.99	0.44

Continued on next page...

Continued from previous page...

Atom-1	Atom-2	Interatomic distance (Å)	Clash overlap (Å)
1:F:54:PHE:CG	1:G:57:GLU:HG2	2.52	0.44
1:A:34:VAL:O	1:A:37:MET:HG3	2.18	0.44
1:B:34:VAL:O	1:B:37:MET:HG3	2.18	0.44
1:B:199:TYR:CD1	1:C:350:VAL:HG23	2.52	0.44
1:B:209:LEU:HA	1:B:209:LEU:HD12	1.82	0.44
1:D:216:CYS:O	1:D:220:THR:HG23	2.17	0.44
1:D:297:VAL:HG23	1:D:298:PRO:HD3	1.99	0.44
1:E:324:GLY:O	1:E:329:SER:OG	2.31	0.44
1:G:6:LEU:HD13	1:G:51:SER:HB3	1.99	0.44
1:G:216:CYS:O	1:G:220:THR:HG23	2.17	0.44
1:E:88:VAL:HA	1:E:94:LEU:HD22	1.97	0.44
1:A:83:TYR:CG	1:A:248:ILE:HG22	2.53	0.44
1:A:297:VAL:HG23	1:A:298:PRO:HD3	1.99	0.44
1:F:83:TYR:CG	1:F:248:ILE:HG22	2.53	0.44
1:A:248:ILE:O	1:A:248:ILE:HG13	2.18	0.43
1:E:83:TYR:CG	1:E:248:ILE:HG22	2.53	0.43
1:F:34:VAL:O	1:F:37:MET:HG3	2.18	0.43
1:F:235:PHE:HZ	2:F:402:PTY:H152	1.83	0.43
2:B:402:PTY:H141	2:B:402:PTY:H111	1.79	0.43
1:C:335:LEU:HD23	1:C:335:LEU:HA	1.88	0.43
1:E:34:VAL:O	1:E:37:MET:HG3	2.18	0.43
1:F:199:TYR:CD1	1:G:350:VAL:HG23	2.53	0.43
1:G:34:VAL:O	1:G:37:MET:HG3	2.18	0.43
1:G:324:GLY:O	1:G:329:SER:OG	2.31	0.43
1:A:126:PHE:CD2	3:B:403:3PE:H3D2	2.54	0.43
1:A:235:PHE:HZ	2:A:402:PTY:H152	1.83	0.43
4:A:407:DGA:HA22	4:A:407:DGA:HG12	1.45	0.43
1:B:235:PHE:HZ	2:B:402:PTY:H152	1.83	0.43
1:C:34:VAL:O	1:C:37:MET:HG3	2.18	0.43
1:E:235:PHE:HZ	2:E:402:PTY:H152	1.83	0.43
1:F:88:VAL:HA	1:F:94:LEU:HD22	1.97	0.43
1:G:222:ILE:HD13	1:G:222:ILE:HA	1.88	0.43
1:G:335:LEU:HD23	1:G:335:LEU:HA	1.88	0.43
1:D:34:VAL:O	1:D:37:MET:HG3	2.18	0.43
1:D:235:PHE:HZ	2:D:402:PTY:H152	1.83	0.43
1:A:222:ILE:HD13	1:A:222:ILE:HA	1.88	0.43
1:B:83:TYR:CG	1:B:248:ILE:HG22	2.53	0.43
1:D:248:ILE:HG13	1:D:248:ILE:O	2.18	0.43
1:E:47:LEU:HD11	1:F:12:PHE:CE2	2.53	0.43
1:E:248:ILE:HG13	1:E:248:ILE:O	2.18	0.43
1:G:248:ILE:O	1:G:248:ILE:HG13	2.18	0.43

Continued on next page...

Continued from previous page...

Atom-1	Atom-2	Interatomic distance (Å)	Clash overlap (Å)
2:D:402:PTY:H141	2:D:402:PTY:H111	1.79	0.43
1:G:83:TYR:CG	1:G:248:ILE:HG22	2.53	0.43
1:C:88:VAL:HA	1:C:94:LEU:HD22	1.97	0.43
1:C:235:PHE:HZ	2:C:402:PTY:H152	1.83	0.43
5:C:404:CLR:H222	5:C:404:CLR:H162	1.58	0.43
2:F:402:PTY:H111	2:F:402:PTY:H141	1.79	0.43
1:C:83:TYR:CG	1:C:248:ILE:HG22	2.53	0.43
1:D:54:PHE:CG	1:E:57:GLU:HG2	2.54	0.43
1:A:350:VAL:HG23	1:G:199:TYR:CD1	2.54	0.43
1:B:248:ILE:O	1:B:248:ILE:HG13	2.18	0.43
1:C:28:LEU:HD23	1:C:28:LEU:HA	1.77	0.43
1:E:339:ILE:HD12	1:E:339:ILE:HA	1.85	0.43
1:A:209:LEU:HD12	1:A:209:LEU:HA	1.82	0.42
1:C:248:ILE:HG13	1:C:248:ILE:O	2.18	0.42
1:C:324:GLY:O	1:C:329:SER:OG	2.31	0.42
1:D:83:TYR:CG	1:D:248:ILE:HG22	2.53	0.42
1:F:248:ILE:HG13	1:F:248:ILE:O	2.18	0.42
1:F:222:ILE:HD13	1:F:222:ILE:HA	1.88	0.42
1:F:342:VAL:HG23	1:F:345:TYR:H	1.85	0.42
1:A:148:LYS:NZ	1:B:369:ASN:O	2.53	0.42
1:B:28:LEU:HD23	1:B:28:LEU:HA	1.77	0.42
2:C:402:PTY:H141	2:C:402:PTY:H111	1.79	0.42
1:A:204:LYS:HA	1:A:328:LEU:HB2	2.02	0.42
1:C:209:LEU:HD12	1:C:209:LEU:HA	1.82	0.42
4:C:406:DGA:HA22	4:C:406:DGA:HG12	1.45	0.42
1:D:339:ILE:HD12	1:D:339:ILE:HA	1.85	0.42
1:G:342:VAL:HG23	1:G:345:TYR:H	1.85	0.42
1:D:199:TYR:CD1	1:E:350:VAL:HG23	2.55	0.42
1:F:76:GLN:HE22	1:G:70:SER:HB2	1.85	0.42
1:F:146:LEU:HD12	1:F:146:LEU:HA	1.94	0.42
1:F:324:GLY:O	1:F:329:SER:OG	2.31	0.42
1:G:135:ILE:HG12	1:G:139:LEU:HD23	2.02	0.42
1:B:235:PHE:CD1	1:B:278:VAL:HB	2.55	0.41
1:C:113:LEU:HD23	1:C:113:LEU:HA	1.87	0.41
1:E:76:GLN:HE22	1:F:70:SER:HB2	1.85	0.41
5:F:404:CLR:H211	5:F:404:CLR:H241	2.02	0.41
1:G:204:LYS:HA	1:G:328:LEU:HB2	2.02	0.41
1:A:342:VAL:O	1:A:342:VAL:HG23	2.20	0.41
5:B:404:CLR:H241	5:B:404:CLR:H211	2.02	0.41
1:C:235:PHE:CD1	1:C:278:VAL:HB	2.55	0.41
5:C:404:CLR:H211	5:C:404:CLR:H241	2.02	0.41

Continued on next page...

Continued from previous page...

Atom-1	Atom-2	Interatomic distance (Å)	Clash overlap (Å)
1:D:204:LYS:HA	1:D:328:LEU:HB2	2.02	0.41
1:E:275:LEU:CD1	2:E:402:PTY:H321	2.51	0.41
1:E:342:VAL:HG23	1:E:345:TYR:H	1.85	0.41
5:G:404:CLR:H241	5:G:404:CLR:H211	2.02	0.41
1:B:342:VAL:HG23	1:B:342:VAL:O	2.20	0.41
1:E:235:PHE:CD1	1:E:278:VAL:HB	2.55	0.41
2:E:402:PTY:H141	2:E:402:PTY:H111	1.79	0.41
1:F:275:LEU:CD1	2:F:402:PTY:H321	2.51	0.41
1:A:135:ILE:HG12	1:A:139:LEU:HD23	2.02	0.41
1:A:235:PHE:CD1	1:A:278:VAL:HB	2.55	0.41
1:D:275:LEU:CD1	2:D:402:PTY:H321	2.51	0.41
1:F:209:LEU:HD12	1:F:209:LEU:HA	1.82	0.41
5:A:405:CLR:H241	5:A:405:CLR:H211	2.02	0.41
3:B:403:3PE:H221	3:B:403:3PE:H2	1.50	0.41
1:E:83:TYR:OH	1:E:250:SER:OG	2.33	0.41
1:E:204:LYS:HA	1:E:328:LEU:HB2	2.02	0.41
5:E:404:CLR:H211	5:E:404:CLR:H241	2.02	0.41
1:F:135:ILE:HG12	1:F:139:LEU:HD23	2.02	0.41
1:G:342:VAL:HG23	1:G:342:VAL:O	2.20	0.41
1:C:219:LEU:HD12	1:C:219:LEU:HA	1.91	0.41
1:C:342:VAL:O	1:C:342:VAL:HG23	2.20	0.41
1:D:342:VAL:O	1:D:342:VAL:HG23	2.20	0.41
5:D:404:CLR:H211	5:D:404:CLR:H241	2.02	0.41
1:E:342:VAL:HG23	1:E:342:VAL:O	2.20	0.41
1:F:15:PHE:CE1	1:F:16:LEU:HD13	2.56	0.41
1:G:235:PHE:CD1	1:G:278:VAL:HB	2.55	0.41
1:G:275:LEU:CD1	2:G:402:PTY:H321	2.51	0.41
1:B:47:LEU:HD11	1:C:12:PHE:CE2	2.55	0.41
1:B:204:LYS:HA	1:B:328:LEU:HB2	2.02	0.41
1:D:222:ILE:HD13	1:D:222:ILE:HA	1.88	0.41
1:F:235:PHE:CD1	1:F:278:VAL:HB	2.55	0.41
1:A:15:PHE:CE1	1:A:16:LEU:HD13	2.56	0.41
1:A:242:ASP:OD1	1:A:242:ASP:N	2.39	0.41
1:A:342:VAL:HG23	1:A:345:TYR:H	1.85	0.41
1:C:76:GLN:HE22	1:D:70:SER:HB2	1.86	0.41
1:D:15:PHE:CE1	1:D:16:LEU:HD13	2.56	0.41
1:D:235:PHE:CD1	1:D:278:VAL:HB	2.55	0.41
1:D:342:VAL:HG23	1:D:345:TYR:H	1.85	0.41
1:E:199:TYR:CD1	1:F:350:VAL:HG23	2.56	0.41
1:A:217:ARG:HB3	1:A:295:LEU:HD12	2.03	0.41
1:A:339:ILE:HD12	1:A:339:ILE:HA	1.85	0.41

Continued on next page...

Continued from previous page...

Atom-1	Atom-2	Interatomic distance (Å)	Clash overlap (Å)
1:B:75:ARG:NH1	1:C:81:ASP:OD2	2.54	0.41
1:B:217:ARG:HB3	1:B:295:LEU:HD12	2.03	0.41
1:C:15:PHE:CE1	1:C:16:LEU:HD13	2.56	0.41
1:C:217:ARG:HB3	1:C:295:LEU:HD12	2.03	0.41
1:D:135:ILE:HG12	1:D:139:LEU:HD23	2.02	0.41
1:E:28:LEU:HD23	1:E:28:LEU:HA	1.77	0.41
1:E:217:ARG:HB3	1:E:295:LEU:HD12	2.03	0.41
1:E:335:LEU:HA	1:E:335:LEU:HD23	1.88	0.41
1:F:75:ARG:NH1	1:G:81:ASP:OD2	2.54	0.41
1:F:342:VAL:HG23	1:F:342:VAL:O	2.20	0.41
3:F:403:3PE:H2	3:F:403:3PE:H221	1.50	0.41
1:G:217:ARG:HB3	1:G:295:LEU:HD12	2.03	0.41
1:A:275:LEU:CD1	2:A:402:PTY:H321	2.51	0.41
1:B:15:PHE:CE1	1:B:16:LEU:HD13	2.56	0.41
1:B:76:GLN:HE22	1:C:70:SER:HB2	1.85	0.41
1:B:275:LEU:CD1	2:B:402:PTY:H321	2.51	0.41
1:C:47:LEU:HD11	1:D:12:PHE:CE2	2.55	0.41
1:C:204:LYS:HA	1:C:328:LEU:HB2	2.02	0.41
1:C:342:VAL:HG23	1:C:345:TYR:H	1.85	0.41
1:D:217:ARG:HB3	1:D:295:LEU:HD12	2.03	0.41
1:E:15:PHE:CE1	1:E:16:LEU:HD13	2.56	0.41
1:F:47:LEU:HD11	1:G:12:PHE:CE2	2.55	0.41
1:F:217:ARG:HB3	1:F:295:LEU:HD12	2.03	0.41
1:G:15:PHE:CE1	1:G:16:LEU:HD13	2.56	0.41
1:G:242:ASP:OD2	1:G:266:LYS:NZ	2.49	0.41
1:G:209:LEU:HD12	1:G:209:LEU:HA	1.82	0.40
1:B:342:VAL:HG23	1:B:345:TYR:H	1.85	0.40
1:C:75:ARG:NH1	1:D:81:ASP:OD2	2.55	0.40
1:C:208:ASN:HD21	1:C:212:LYS:HE3	1.86	0.40
1:C:275:LEU:CD1	2:C:402:PTY:H321	2.51	0.40
1:D:324:GLY:O	1:D:329:SER:OG	2.31	0.40
1:E:135:ILE:HG12	1:E:139:LEU:HD23	2.02	0.40
1:F:85:TRP:CH2	1:F:107:LYS:HG3	2.56	0.40
1:F:204:LYS:HA	1:F:328:LEU:HB2	2.02	0.40
1:A:75:ARG:HG3	1:B:77:ALA:HB3	2.03	0.40
1:B:135:ILE:HG12	1:B:139:LEU:HD23	2.02	0.40
1:D:330:LEU:HD12	1:D:330:LEU:HA	1.87	0.40
1:E:85:TRP:CH2	1:E:107:LYS:HG3	2.57	0.40
1:A:208:ASN:HD21	1:A:212:LYS:HE3	1.86	0.40
5:D:404:CLR:H222	5:D:404:CLR:H162	1.58	0.40
1:F:208:ASN:HD21	1:F:212:LYS:HE3	1.86	0.40

Continued on next page...

Continued from previous page...

Atom-1	Atom-2	Interatomic distance (Å)	Clash overlap (Å)
1:C:85:TRP:CH2	1:C:107:LYS:HG3	2.56	0.40
1:C:135:ILE:HG12	1:C:139:LEU:HD23	2.02	0.40
1:D:85:TRP:CH2	1:D:107:LYS:HG3	2.57	0.40
1:D:208:ASN:HD21	1:D:212:LYS:HE3	1.86	0.40

There are no symmetry-related clashes.

5.3 Torsion angles [i](#)

5.3.1 Protein backbone [i](#)

In the following table, the Percentiles column shows the percent Ramachandran outliers of the chain as a percentile score with respect to all PDB entries followed by that with respect to all EM entries.

The Analysed column shows the number of residues for which the backbone conformation was analysed, and the total number of residues.

Mol	Chain	Analysed	Favoured	Allowed	Outliers	Percentiles	
1	A	337/373 (90%)	318 (94%)	19 (6%)	0	100	100
1	B	337/373 (90%)	319 (95%)	18 (5%)	0	100	100
1	C	337/373 (90%)	318 (94%)	19 (6%)	0	100	100
1	D	337/373 (90%)	318 (94%)	19 (6%)	0	100	100
1	E	337/373 (90%)	318 (94%)	19 (6%)	0	100	100
1	F	337/373 (90%)	318 (94%)	19 (6%)	0	100	100
1	G	337/373 (90%)	318 (94%)	19 (6%)	0	100	100
All	All	2359/2611 (90%)	2227 (94%)	132 (6%)	0	100	100

There are no Ramachandran outliers to report.

5.3.2 Protein sidechains [i](#)

In the following table, the Percentiles column shows the percent sidechain outliers of the chain as a percentile score with respect to all PDB entries followed by that with respect to all EM entries.

The Analysed column shows the number of residues for which the sidechain conformation was analysed, and the total number of residues.

Mol	Chain	Analysed	Rotameric	Outliers	Percentiles	
1	A	251/335 (75%)	250 (100%)	1 (0%)	91	96
1	B	251/335 (75%)	250 (100%)	1 (0%)	91	96
1	C	251/335 (75%)	250 (100%)	1 (0%)	91	96
1	D	251/335 (75%)	250 (100%)	1 (0%)	91	96
1	E	251/335 (75%)	250 (100%)	1 (0%)	91	96
1	F	251/335 (75%)	250 (100%)	1 (0%)	91	96
1	G	251/335 (75%)	250 (100%)	1 (0%)	91	96
All	All	1757/2345 (75%)	1750 (100%)	7 (0%)	91	96

All (7) residues with a non-rotameric sidechain are listed below:

Mol	Chain	Res	Type
1	A	246	CYS
1	B	246	CYS
1	C	246	CYS
1	D	246	CYS
1	E	246	CYS
1	F	246	CYS
1	G	246	CYS

Sometimes sidechains can be flipped to improve hydrogen bonding and reduce clashes. All (14) such sidechains are listed below:

Mol	Chain	Res	Type
1	A	76	GLN
1	A	134	HIS
1	B	76	GLN
1	B	134	HIS
1	C	76	GLN
1	C	134	HIS
1	D	76	GLN
1	D	134	HIS
1	E	76	GLN
1	E	134	HIS
1	F	76	GLN
1	F	134	HIS
1	G	76	GLN
1	G	134	HIS

5.3.3 RNA [i](#)

There are no RNA molecules in this entry.

5.4 Non-standard residues in protein, DNA, RNA chains [i](#)

There are no non-standard protein/DNA/RNA residues in this entry.

5.5 Carbohydrates [i](#)

There are no monosaccharides in this entry.

5.6 Ligand geometry [i](#)

42 ligands are modelled in this entry.

In the following table, the Counts columns list the number of bonds (or angles) for which Mogul statistics could be retrieved, the number of bonds (or angles) that are observed in the model and the number of bonds (or angles) that are defined in the Chemical Component Dictionary. The Link column lists molecule types, if any, to which the group is linked. The Z score for a bond length (or angle) is the number of standard deviations the observed value is removed from the expected value. A bond length (or angle) with $|Z| > 2$ is considered an outlier worth inspection. RMSZ is the root-mean-square of all Z scores of the bond lengths (or angles).

Mol	Type	Chain	Res	Link	Bond lengths			Bond angles		
					Counts	RMSZ	$\# Z > 2$	Counts	RMSZ	$\# Z > 2$
3	3PE	D	403	-	41,41,50	0.30	0	44,46,55	0.43	0
2	PTY	E	401	-	41,41,49	0.29	0	44,46,54	0.33	0
5	CLR	F	405	-	31,31,31	0.27	0	48,48,48	0.39	0
2	PTY	G	402	-	38,38,49	0.30	0	41,43,54	0.35	0
5	CLR	E	405	-	31,31,31	0.28	0	48,48,48	0.39	0
5	CLR	F	404	-	31,31,31	0.27	0	48,48,48	0.42	0
5	CLR	C	404	-	31,31,31	0.27	0	48,48,48	0.42	0
5	CLR	B	405	-	31,31,31	0.28	0	48,48,48	0.39	0
2	PTY	D	401	-	41,41,49	0.29	0	44,46,54	0.33	0
3	3PE	A	403	-	41,41,50	0.30	0	44,46,55	0.43	0
2	PTY	D	402	-	38,38,49	0.29	0	41,43,54	0.35	0
3	3PE	C	403	-	41,41,50	0.30	0	44,46,55	0.43	0
4	DGA	D	406	-	24,24,43	0.27	0	26,26,45	0.42	0
2	PTY	A	402	-	38,38,49	0.29	0	41,43,54	0.35	0
5	CLR	G	404	-	31,31,31	0.26	0	48,48,48	0.42	0
3	3PE	G	403	-	41,41,50	0.30	0	44,46,55	0.43	0
4	DGA	A	404	-	24,24,43	0.27	0	26,26,45	0.42	0
2	PTY	A	401	-	41,41,49	0.29	0	44,46,54	0.33	0

Mol	Type	Chain	Res	Link	Bond lengths			Bond angles		
					Counts	RMSZ	# Z > 2	Counts	RMSZ	# Z > 2
5	CLR	B	404	-	31,31,31	0.27	0	48,48,48	0.42	0
4	DGA	F	406	-	24,24,43	0.27	0	26,26,45	0.43	0
3	3PE	B	403	-	41,41,50	0.30	0	44,46,55	0.43	0
2	PTY	F	402	-	38,38,49	0.30	0	41,43,54	0.35	0
4	DGA	A	407	-	24,24,43	0.27	0	26,26,45	0.42	0
4	DGA	C	406	-	24,24,43	0.27	0	26,26,45	0.42	0
2	PTY	C	402	-	38,38,49	0.29	0	41,43,54	0.35	0
5	CLR	A	405	-	31,31,31	0.27	0	48,48,48	0.42	0
2	PTY	C	401	-	41,41,49	0.29	0	44,46,54	0.33	0
4	DGA	B	406	-	24,24,43	0.27	0	26,26,45	0.42	0
2	PTY	F	401	-	41,41,49	0.29	0	44,46,54	0.33	0
3	3PE	E	403	-	41,41,50	0.29	0	44,46,55	0.43	0
3	3PE	F	403	-	41,41,50	0.30	0	44,46,55	0.43	0
2	PTY	E	402	-	38,38,49	0.29	0	41,43,54	0.35	0
5	CLR	E	404	-	31,31,31	0.26	0	48,48,48	0.42	0
2	PTY	B	401	-	41,41,49	0.29	0	44,46,54	0.33	0
2	PTY	B	402	-	38,38,49	0.29	0	41,43,54	0.35	0
2	PTY	G	401	-	41,41,49	0.29	0	44,46,54	0.33	0
5	CLR	D	405	-	31,31,31	0.28	0	48,48,48	0.39	0
5	CLR	G	405	-	31,31,31	0.28	0	48,48,48	0.39	0
5	CLR	C	405	-	31,31,31	0.28	0	48,48,48	0.39	0
4	DGA	E	406	-	24,24,43	0.27	0	26,26,45	0.42	0
5	CLR	A	406	-	31,31,31	0.28	0	48,48,48	0.39	0
5	CLR	D	404	-	31,31,31	0.26	0	48,48,48	0.42	0

In the following table, the Chirals column lists the number of chiral outliers, the number of chiral centers analysed, the number of these observed in the model and the number defined in the Chemical Component Dictionary. Similar counts are reported in the Torsion and Rings columns. '-' means no outliers of that kind were identified.

Mol	Type	Chain	Res	Link	Chirals	Torsions	Rings
3	3PE	D	403	-	-	4/45/45/54	-
2	PTY	E	401	-	-	25/45/45/53	-
5	CLR	F	405	-	-	1/10/68/68	0/4/4/4
2	PTY	G	402	-	-	22/42/42/53	-
5	CLR	E	405	-	-	1/10/68/68	0/4/4/4
5	CLR	F	404	-	-	6/10/68/68	0/4/4/4
5	CLR	C	404	-	-	6/10/68/68	0/4/4/4
5	CLR	B	405	-	-	1/10/68/68	0/4/4/4
2	PTY	D	401	-	-	25/45/45/53	-
3	3PE	A	403	-	-	4/45/45/54	-

Continued on next page...

Continued from previous page...

Mol	Type	Chain	Res	Link	Chirals	Torsions	Rings
2	PTY	D	402	-	-	22/42/42/53	-
3	3PE	C	403	-	-	4/45/45/54	-
4	DGA	D	406	-	-	3/26/26/45	-
2	PTY	A	402	-	-	22/42/42/53	-
5	CLR	G	404	-	-	6/10/68/68	0/4/4/4
3	3PE	G	403	-	-	4/45/45/54	-
4	DGA	A	404	-	-	3/26/26/45	-
2	PTY	A	401	-	-	25/45/45/53	-
5	CLR	B	404	-	-	6/10/68/68	0/4/4/4
4	DGA	F	406	-	-	3/26/26/45	-
3	3PE	B	403	-	-	4/45/45/54	-
2	PTY	F	402	-	-	22/42/42/53	-
4	DGA	A	407	-	-	3/26/26/45	-
4	DGA	C	406	-	-	3/26/26/45	-
2	PTY	C	402	-	-	22/42/42/53	-
5	CLR	A	405	-	-	6/10/68/68	0/4/4/4
2	PTY	C	401	-	-	25/45/45/53	-
4	DGA	B	406	-	-	3/26/26/45	-
2	PTY	F	401	-	-	25/45/45/53	-
3	3PE	E	403	-	-	4/45/45/54	-
3	3PE	F	403	-	-	4/45/45/54	-
2	PTY	E	402	-	-	22/42/42/53	-
5	CLR	E	404	-	-	6/10/68/68	0/4/4/4
2	PTY	B	401	-	-	25/45/45/53	-
2	PTY	B	402	-	-	22/42/42/53	-
2	PTY	G	401	-	-	25/45/45/53	-
5	CLR	D	405	-	-	1/10/68/68	0/4/4/4
5	CLR	G	405	-	-	1/10/68/68	0/4/4/4
5	CLR	C	405	-	-	1/10/68/68	0/4/4/4
4	DGA	E	406	-	-	3/26/26/45	-
5	CLR	A	406	-	-	1/10/68/68	0/4/4/4
5	CLR	D	404	-	-	6/10/68/68	0/4/4/4

There are no bond length outliers.

There are no bond angle outliers.

There are no chirality outliers.

All (427) torsion outliers are listed below:

Mol	Chain	Res	Type	Atoms
2	A	401	PTY	C11-C8-O7-C6
2	A	401	PTY	C5-O14-P1-O12
2	A	401	PTY	C5-O14-P1-O13
2	A	402	PTY	N1-C2-C3-O11
2	A	402	PTY	C11-C8-O7-C6
2	A	402	PTY	C3-O11-P1-O12
2	A	402	PTY	C3-O11-P1-O13
2	A	402	PTY	C3-O11-P1-O14
2	B	401	PTY	C11-C8-O7-C6
2	B	401	PTY	C5-O14-P1-O12
2	B	401	PTY	C5-O14-P1-O13
2	B	402	PTY	N1-C2-C3-O11
2	B	402	PTY	C11-C8-O7-C6
2	B	402	PTY	C3-O11-P1-O12
2	B	402	PTY	C3-O11-P1-O13
2	B	402	PTY	C3-O11-P1-O14
2	C	401	PTY	C11-C8-O7-C6
2	C	401	PTY	C5-O14-P1-O12
2	C	401	PTY	C5-O14-P1-O13
2	C	402	PTY	N1-C2-C3-O11
2	C	402	PTY	C11-C8-O7-C6
2	C	402	PTY	C3-O11-P1-O12
2	C	402	PTY	C3-O11-P1-O13
2	C	402	PTY	C3-O11-P1-O14
2	D	401	PTY	C11-C8-O7-C6
2	D	401	PTY	C5-O14-P1-O12
2	D	401	PTY	C5-O14-P1-O13
2	D	402	PTY	N1-C2-C3-O11
2	D	402	PTY	C11-C8-O7-C6
2	D	402	PTY	C3-O11-P1-O12
2	D	402	PTY	C3-O11-P1-O13
2	D	402	PTY	C3-O11-P1-O14
2	E	401	PTY	C11-C8-O7-C6
2	E	401	PTY	C5-O14-P1-O12
2	E	401	PTY	C5-O14-P1-O13
2	E	402	PTY	N1-C2-C3-O11
2	E	402	PTY	C11-C8-O7-C6
2	E	402	PTY	C3-O11-P1-O12
2	E	402	PTY	C3-O11-P1-O13
2	E	402	PTY	C3-O11-P1-O14

Continued on next page...

Continued from previous page...

Mol	Chain	Res	Type	Atoms
2	F	401	PTY	C11-C8-O7-C6
2	F	401	PTY	C5-O14-P1-O12
2	F	401	PTY	C5-O14-P1-O13
2	F	402	PTY	N1-C2-C3-O11
2	F	402	PTY	C11-C8-O7-C6
2	F	402	PTY	C3-O11-P1-O12
2	F	402	PTY	C3-O11-P1-O13
2	F	402	PTY	C3-O11-P1-O14
2	G	401	PTY	C11-C8-O7-C6
2	G	401	PTY	C5-O14-P1-O12
2	G	401	PTY	C5-O14-P1-O13
2	G	402	PTY	N1-C2-C3-O11
2	G	402	PTY	C11-C8-O7-C6
2	G	402	PTY	C3-O11-P1-O12
2	G	402	PTY	C3-O11-P1-O13
2	G	402	PTY	C3-O11-P1-O14
3	A	403	3PE	O22-C21-O21-C2
3	A	403	3PE	C22-C21-O21-C2
3	B	403	3PE	O22-C21-O21-C2
3	B	403	3PE	C22-C21-O21-C2
3	C	403	3PE	O22-C21-O21-C2
3	C	403	3PE	C22-C21-O21-C2
3	D	403	3PE	O22-C21-O21-C2
3	D	403	3PE	C22-C21-O21-C2
3	E	403	3PE	O22-C21-O21-C2
3	E	403	3PE	C22-C21-O21-C2
3	F	403	3PE	O22-C21-O21-C2
3	F	403	3PE	C22-C21-O21-C2
3	G	403	3PE	O22-C21-O21-C2
3	G	403	3PE	C22-C21-O21-C2
4	A	404	DGA	CA2-CA1-OG1-CG1
4	A	404	DGA	OA1-CA1-OG1-CG1
4	A	407	DGA	CA2-CA1-OG1-CG1
4	A	407	DGA	OA1-CA1-OG1-CG1
4	B	406	DGA	CA2-CA1-OG1-CG1
4	B	406	DGA	OA1-CA1-OG1-CG1
4	C	406	DGA	CA2-CA1-OG1-CG1
4	C	406	DGA	OA1-CA1-OG1-CG1
4	D	406	DGA	CA2-CA1-OG1-CG1
4	D	406	DGA	OA1-CA1-OG1-CG1
4	E	406	DGA	CA2-CA1-OG1-CG1
4	E	406	DGA	OA1-CA1-OG1-CG1

Continued on next page...

Continued from previous page...

Mol	Chain	Res	Type	Atoms
4	F	406	DGA	CA2-CA1-OG1-CG1
4	F	406	DGA	OA1-CA1-OG1-CG1
2	A	401	PTY	O10-C8-O7-C6
2	A	402	PTY	O10-C8-O7-C6
2	B	401	PTY	O10-C8-O7-C6
2	B	402	PTY	O10-C8-O7-C6
2	C	401	PTY	O10-C8-O7-C6
2	C	402	PTY	O10-C8-O7-C6
2	D	401	PTY	O10-C8-O7-C6
2	D	402	PTY	O10-C8-O7-C6
2	E	401	PTY	O10-C8-O7-C6
2	E	402	PTY	O10-C8-O7-C6
2	F	401	PTY	O10-C8-O7-C6
2	F	402	PTY	O10-C8-O7-C6
2	G	401	PTY	O10-C8-O7-C6
2	G	402	PTY	O10-C8-O7-C6
5	B	404	CLR	C16-C17-C20-C21
5	C	404	CLR	C16-C17-C20-C21
5	F	404	CLR	C16-C17-C20-C21
2	A	402	PTY	C37-C38-C39-C40
2	B	402	PTY	C37-C38-C39-C40
2	C	402	PTY	C37-C38-C39-C40
2	D	402	PTY	C37-C38-C39-C40
2	E	402	PTY	C37-C38-C39-C40
2	F	402	PTY	C37-C38-C39-C40
2	G	402	PTY	C37-C38-C39-C40
5	A	405	CLR	C16-C17-C20-C21
5	D	404	CLR	C16-C17-C20-C21
5	E	404	CLR	C16-C17-C20-C21
5	G	404	CLR	C16-C17-C20-C21
5	A	405	CLR	C13-C17-C20-C21
5	B	404	CLR	C13-C17-C20-C21
5	C	404	CLR	C13-C17-C20-C21
5	D	404	CLR	C13-C17-C20-C21
5	E	404	CLR	C13-C17-C20-C21
5	F	404	CLR	C13-C17-C20-C21
5	G	404	CLR	C13-C17-C20-C21
5	A	405	CLR	C13-C17-C20-C22
5	B	404	CLR	C13-C17-C20-C22
5	C	404	CLR	C13-C17-C20-C22
5	D	404	CLR	C13-C17-C20-C22
5	E	404	CLR	C13-C17-C20-C22

Continued on next page...

Continued from previous page...

Mol	Chain	Res	Type	Atoms
5	F	404	CLR	C13-C17-C20-C22
5	G	404	CLR	C13-C17-C20-C22
2	A	402	PTY	C31-C30-O4-C1
2	B	402	PTY	C31-C30-O4-C1
2	C	402	PTY	C31-C30-O4-C1
2	D	402	PTY	C31-C30-O4-C1
2	E	402	PTY	C31-C30-O4-C1
2	F	402	PTY	C31-C30-O4-C1
2	G	402	PTY	C31-C30-O4-C1
5	A	405	CLR	C16-C17-C20-C22
5	B	404	CLR	C16-C17-C20-C22
5	C	404	CLR	C16-C17-C20-C22
5	D	404	CLR	C16-C17-C20-C22
5	E	404	CLR	C16-C17-C20-C22
5	F	404	CLR	C16-C17-C20-C22
5	G	404	CLR	C16-C17-C20-C22
2	A	402	PTY	O30-C30-O4-C1
2	B	402	PTY	O30-C30-O4-C1
2	C	402	PTY	O30-C30-O4-C1
2	D	402	PTY	O30-C30-O4-C1
2	E	402	PTY	O30-C30-O4-C1
2	F	402	PTY	O30-C30-O4-C1
2	G	402	PTY	O30-C30-O4-C1
2	A	401	PTY	C30-C31-C32-C33
2	B	401	PTY	C30-C31-C32-C33
2	C	401	PTY	C30-C31-C32-C33
2	D	401	PTY	C30-C31-C32-C33
2	E	401	PTY	C30-C31-C32-C33
2	F	401	PTY	C30-C31-C32-C33
2	G	401	PTY	C30-C31-C32-C33
2	A	402	PTY	C35-C36-C37-C38
2	B	402	PTY	C35-C36-C37-C38
2	C	402	PTY	C35-C36-C37-C38
2	D	402	PTY	C35-C36-C37-C38
2	E	402	PTY	C35-C36-C37-C38
2	F	402	PTY	C35-C36-C37-C38
2	G	402	PTY	C35-C36-C37-C38
2	A	402	PTY	C8-C11-C12-C13
2	B	402	PTY	C8-C11-C12-C13
2	C	402	PTY	C8-C11-C12-C13
2	D	402	PTY	C8-C11-C12-C13
2	E	402	PTY	C8-C11-C12-C13

Continued on next page...

Continued from previous page...

Mol	Chain	Res	Type	Atoms
2	F	402	PTY	C8-C11-C12-C13
2	G	402	PTY	C8-C11-C12-C13
2	A	401	PTY	C5-O14-P1-O11
2	B	401	PTY	C5-O14-P1-O11
2	C	401	PTY	C5-O14-P1-O11
2	D	401	PTY	C5-O14-P1-O11
2	E	401	PTY	C5-O14-P1-O11
2	F	401	PTY	C5-O14-P1-O11
2	G	401	PTY	C5-O14-P1-O11
2	A	401	PTY	C14-C15-C16-C17
2	B	401	PTY	C14-C15-C16-C17
2	C	401	PTY	C14-C15-C16-C17
2	D	401	PTY	C14-C15-C16-C17
2	D	401	PTY	C32-C33-C34-C35
2	E	401	PTY	C14-C15-C16-C17
2	E	401	PTY	C32-C33-C34-C35
2	F	401	PTY	C14-C15-C16-C17
2	F	401	PTY	C32-C33-C34-C35
2	G	401	PTY	C14-C15-C16-C17
2	G	401	PTY	C32-C33-C34-C35
2	A	401	PTY	C1-C6-O7-C8
2	A	402	PTY	C1-C6-O7-C8
2	B	401	PTY	C1-C6-O7-C8
2	B	402	PTY	C1-C6-O7-C8
2	C	401	PTY	C1-C6-O7-C8
2	C	402	PTY	C1-C6-O7-C8
2	D	401	PTY	C1-C6-O7-C8
2	D	402	PTY	C1-C6-O7-C8
2	E	401	PTY	C1-C6-O7-C8
2	E	402	PTY	C1-C6-O7-C8
2	F	401	PTY	C1-C6-O7-C8
2	F	402	PTY	C1-C6-O7-C8
2	G	401	PTY	C1-C6-O7-C8
2	G	402	PTY	C1-C6-O7-C8
2	A	401	PTY	C32-C33-C34-C35
2	B	401	PTY	C17-C18-C19-C20
2	B	401	PTY	C32-C33-C34-C35
2	C	401	PTY	C17-C18-C19-C20
2	C	401	PTY	C32-C33-C34-C35
2	D	401	PTY	C17-C18-C19-C20
2	E	401	PTY	C17-C18-C19-C20
2	F	401	PTY	C17-C18-C19-C20

Continued on next page...

Continued from previous page...

Mol	Chain	Res	Type	Atoms
2	G	401	PTY	C17-C18-C19-C20
2	A	401	PTY	C17-C18-C19-C20
2	A	402	PTY	C16-C17-C18-C19
2	C	402	PTY	C16-C17-C18-C19
2	E	402	PTY	C16-C17-C18-C19
2	B	402	PTY	C16-C17-C18-C19
2	D	402	PTY	C16-C17-C18-C19
2	F	402	PTY	C16-C17-C18-C19
2	G	402	PTY	C16-C17-C18-C19
2	A	402	PTY	C33-C34-C35-C36
2	B	402	PTY	C33-C34-C35-C36
2	C	402	PTY	C33-C34-C35-C36
2	D	402	PTY	C33-C34-C35-C36
2	E	402	PTY	C33-C34-C35-C36
2	F	402	PTY	C33-C34-C35-C36
2	G	402	PTY	C33-C34-C35-C36
2	A	401	PTY	C31-C30-O4-C1
2	B	401	PTY	C31-C30-O4-C1
2	C	401	PTY	C31-C30-O4-C1
2	D	401	PTY	C31-C30-O4-C1
2	E	401	PTY	C31-C30-O4-C1
2	F	401	PTY	C31-C30-O4-C1
2	G	401	PTY	C31-C30-O4-C1
2	A	401	PTY	C31-C32-C33-C34
2	A	401	PTY	C34-C35-C36-C37
2	B	401	PTY	C31-C32-C33-C34
2	B	401	PTY	C34-C35-C36-C37
2	C	401	PTY	C31-C32-C33-C34
2	C	401	PTY	C34-C35-C36-C37
2	D	401	PTY	C31-C32-C33-C34
2	D	401	PTY	C34-C35-C36-C37
2	E	401	PTY	C31-C32-C33-C34
2	E	401	PTY	C34-C35-C36-C37
2	F	401	PTY	C31-C32-C33-C34
2	F	401	PTY	C34-C35-C36-C37
2	G	401	PTY	C31-C32-C33-C34
2	G	401	PTY	C34-C35-C36-C37
2	A	402	PTY	C31-C32-C33-C34
2	B	402	PTY	C31-C32-C33-C34
2	C	402	PTY	C31-C32-C33-C34
2	D	402	PTY	C31-C32-C33-C34
2	F	402	PTY	C31-C32-C33-C34

Continued on next page...

Continued from previous page...

Mol	Chain	Res	Type	Atoms
2	G	402	PTY	C31-C32-C33-C34
2	E	402	PTY	C31-C32-C33-C34
2	A	401	PTY	O30-C30-O4-C1
2	B	401	PTY	O30-C30-O4-C1
2	C	401	PTY	O30-C30-O4-C1
2	D	401	PTY	O30-C30-O4-C1
2	E	401	PTY	O30-C30-O4-C1
2	F	401	PTY	O30-C30-O4-C1
2	G	401	PTY	O30-C30-O4-C1
2	A	401	PTY	C35-C36-C37-C38
2	B	401	PTY	C35-C36-C37-C38
2	C	401	PTY	C33-C34-C35-C36
2	C	401	PTY	C35-C36-C37-C38
2	D	401	PTY	C33-C34-C35-C36
2	D	401	PTY	C35-C36-C37-C38
2	E	401	PTY	C33-C34-C35-C36
2	E	401	PTY	C35-C36-C37-C38
2	F	401	PTY	C35-C36-C37-C38
2	G	401	PTY	C33-C34-C35-C36
2	G	401	PTY	C35-C36-C37-C38
2	A	401	PTY	C33-C34-C35-C36
2	B	401	PTY	C33-C34-C35-C36
2	F	401	PTY	C33-C34-C35-C36
2	A	401	PTY	O14-C5-C6-C1
2	B	401	PTY	O14-C5-C6-C1
2	C	401	PTY	O14-C5-C6-C1
2	D	401	PTY	O14-C5-C6-C1
2	E	401	PTY	O14-C5-C6-C1
2	F	401	PTY	O14-C5-C6-C1
2	G	401	PTY	O14-C5-C6-C1
2	A	402	PTY	C30-C31-C32-C33
2	B	402	PTY	C30-C31-C32-C33
2	C	402	PTY	C30-C31-C32-C33
2	D	402	PTY	C30-C31-C32-C33
2	E	402	PTY	C30-C31-C32-C33
2	F	402	PTY	C30-C31-C32-C33
2	G	402	PTY	C30-C31-C32-C33
2	B	402	PTY	C34-C35-C36-C37
2	A	402	PTY	C34-C35-C36-C37
2	C	402	PTY	C34-C35-C36-C37
2	D	402	PTY	C34-C35-C36-C37
2	E	402	PTY	C34-C35-C36-C37

Continued on next page...

Continued from previous page...

Mol	Chain	Res	Type	Atoms
2	F	402	PTY	C34-C35-C36-C37
2	G	402	PTY	C34-C35-C36-C37
2	F	402	PTY	C15-C16-C17-C18
2	G	402	PTY	C15-C16-C17-C18
2	A	402	PTY	C15-C16-C17-C18
2	B	402	PTY	C15-C16-C17-C18
2	C	402	PTY	C15-C16-C17-C18
2	D	402	PTY	C15-C16-C17-C18
2	E	402	PTY	C15-C16-C17-C18
2	G	401	PTY	C37-C38-C39-C40
2	A	401	PTY	C37-C38-C39-C40
2	B	401	PTY	C37-C38-C39-C40
2	C	401	PTY	C37-C38-C39-C40
2	D	401	PTY	C37-C38-C39-C40
2	E	401	PTY	C37-C38-C39-C40
2	F	401	PTY	C37-C38-C39-C40
2	A	401	PTY	O14-C5-C6-O7
2	B	401	PTY	O14-C5-C6-O7
2	C	401	PTY	O14-C5-C6-O7
2	D	401	PTY	O14-C5-C6-O7
2	E	401	PTY	O14-C5-C6-O7
2	F	401	PTY	O14-C5-C6-O7
2	G	401	PTY	O14-C5-C6-O7
2	E	402	PTY	C14-C15-C16-C17
2	A	402	PTY	C14-C15-C16-C17
2	G	402	PTY	C14-C15-C16-C17
2	C	402	PTY	C14-C15-C16-C17
2	D	402	PTY	C14-C15-C16-C17
2	B	402	PTY	C14-C15-C16-C17
2	F	402	PTY	C14-C15-C16-C17
5	G	404	CLR	C17-C20-C22-C23
5	A	405	CLR	C17-C20-C22-C23
5	B	404	CLR	C17-C20-C22-C23
5	C	404	CLR	C17-C20-C22-C23
5	D	404	CLR	C17-C20-C22-C23
5	E	404	CLR	C17-C20-C22-C23
5	F	404	CLR	C17-C20-C22-C23
2	A	401	PTY	C3-O11-P1-O14
2	B	401	PTY	C3-O11-P1-O14
2	C	401	PTY	C3-O11-P1-O14
2	D	401	PTY	C3-O11-P1-O14
2	E	401	PTY	C3-O11-P1-O14

Continued on next page...

Continued from previous page...

Mol	Chain	Res	Type	Atoms
2	F	401	PTY	C3-O11-P1-O14
2	G	401	PTY	C3-O11-P1-O14
5	A	406	CLR	C20-C22-C23-C24
5	B	405	CLR	C20-C22-C23-C24
5	C	405	CLR	C20-C22-C23-C24
5	D	405	CLR	C20-C22-C23-C24
5	E	405	CLR	C20-C22-C23-C24
5	F	405	CLR	C20-C22-C23-C24
5	G	405	CLR	C20-C22-C23-C24
2	A	401	PTY	C2-C3-O11-P1
2	B	401	PTY	C2-C3-O11-P1
2	C	401	PTY	C2-C3-O11-P1
2	D	401	PTY	C2-C3-O11-P1
2	E	401	PTY	C2-C3-O11-P1
2	F	401	PTY	C2-C3-O11-P1
2	G	401	PTY	C2-C3-O11-P1
3	A	403	3PE	C12-C11-O13-P
3	B	403	3PE	C12-C11-O13-P
3	C	403	3PE	C12-C11-O13-P
3	D	403	3PE	C12-C11-O13-P
3	E	403	3PE	C12-C11-O13-P
3	F	403	3PE	C12-C11-O13-P
3	G	403	3PE	C12-C11-O13-P
2	A	402	PTY	C12-C11-C8-O7
2	C	402	PTY	C12-C11-C8-O7
2	D	402	PTY	C12-C11-C8-O7
2	F	402	PTY	C12-C11-C8-O7
2	B	402	PTY	C12-C11-C8-O7
2	E	402	PTY	C12-C11-C8-O7
2	G	402	PTY	C12-C11-C8-O7
2	A	401	PTY	C6-C5-O14-P1
2	B	401	PTY	C6-C5-O14-P1
2	C	401	PTY	C6-C5-O14-P1
2	D	401	PTY	C6-C5-O14-P1
2	E	401	PTY	C6-C5-O14-P1
2	F	401	PTY	C6-C5-O14-P1
2	G	401	PTY	C6-C5-O14-P1
2	B	402	PTY	C11-C12-C13-C14
2	D	402	PTY	C11-C12-C13-C14
2	A	402	PTY	C11-C12-C13-C14
2	C	402	PTY	C11-C12-C13-C14
2	E	402	PTY	C11-C12-C13-C14

Continued on next page...

Continued from previous page...

Mol	Chain	Res	Type	Atoms
2	F	402	PTY	C11-C12-C13-C14
2	G	402	PTY	C11-C12-C13-C14
5	A	405	CLR	C21-C20-C22-C23
5	B	404	CLR	C21-C20-C22-C23
5	C	404	CLR	C21-C20-C22-C23
5	D	404	CLR	C21-C20-C22-C23
5	E	404	CLR	C21-C20-C22-C23
5	F	404	CLR	C21-C20-C22-C23
5	G	404	CLR	C21-C20-C22-C23
2	A	401	PTY	O4-C1-C6-C5
2	B	401	PTY	O4-C1-C6-C5
2	C	401	PTY	O4-C1-C6-C5
2	D	401	PTY	O4-C1-C6-C5
2	E	401	PTY	O4-C1-C6-C5
2	F	401	PTY	O4-C1-C6-C5
2	G	401	PTY	O4-C1-C6-C5
2	B	402	PTY	C12-C13-C14-C15
2	C	402	PTY	C12-C13-C14-C15
2	D	402	PTY	C12-C13-C14-C15
2	G	402	PTY	C12-C13-C14-C15
2	A	402	PTY	C12-C13-C14-C15
2	E	401	PTY	C12-C13-C14-C15
2	E	402	PTY	C12-C13-C14-C15
2	F	402	PTY	C12-C13-C14-C15
2	F	401	PTY	C12-C13-C14-C15
2	B	401	PTY	C12-C13-C14-C15
2	C	401	PTY	C12-C13-C14-C15
2	D	401	PTY	C12-C13-C14-C15
2	G	401	PTY	C12-C13-C14-C15
2	A	401	PTY	C12-C13-C14-C15
4	C	406	DGA	OG1-CA1-CA2-CA3
4	A	404	DGA	OG1-CA1-CA2-CA3
4	D	406	DGA	OG1-CA1-CA2-CA3
4	F	406	DGA	OG1-CA1-CA2-CA3
4	A	407	DGA	OG1-CA1-CA2-CA3
4	B	406	DGA	OG1-CA1-CA2-CA3
4	E	406	DGA	OG1-CA1-CA2-CA3
3	A	403	3PE	O21-C21-C22-C23
3	B	403	3PE	O21-C21-C22-C23
3	C	403	3PE	O21-C21-C22-C23
3	D	403	3PE	O21-C21-C22-C23
3	E	403	3PE	O21-C21-C22-C23

Continued on next page...

Continued from previous page...

Mol	Chain	Res	Type	Atoms
3	F	403	3PE	O21-C21-C22-C23
3	G	403	3PE	O21-C21-C22-C23
2	A	401	PTY	O4-C30-C31-C32
2	B	401	PTY	O4-C30-C31-C32
2	C	401	PTY	O4-C30-C31-C32
2	D	401	PTY	O4-C30-C31-C32
2	E	401	PTY	O4-C30-C31-C32
2	F	401	PTY	O4-C30-C31-C32
2	G	401	PTY	O4-C30-C31-C32

There are no ring outliers.

42 monomers are involved in 172 short contacts:

Mol	Chain	Res	Type	Clashes	Symm-Clashes
3	D	403	3PE	5	0
2	E	401	PTY	7	0
5	F	405	CLR	2	0
2	G	402	PTY	6	0
5	E	405	CLR	2	0
5	F	404	CLR	4	0
5	C	404	CLR	4	0
5	B	405	CLR	2	0
2	D	401	PTY	7	0
3	A	403	3PE	5	0
2	D	402	PTY	7	0
3	C	403	3PE	5	0
4	D	406	DGA	2	0
2	A	402	PTY	7	0
5	G	404	CLR	4	0
3	G	403	3PE	5	0
4	A	404	DGA	2	0
2	A	401	PTY	7	0
5	B	404	CLR	4	0
4	F	406	DGA	2	0
3	B	403	3PE	5	0
2	F	402	PTY	7	0
4	A	407	DGA	2	0
4	C	406	DGA	2	0
2	C	402	PTY	7	0
5	A	405	CLR	4	0
2	C	401	PTY	7	0
4	B	406	DGA	1	0

Continued on next page...

Continued from previous page...

Mol	Chain	Res	Type	Clashes	Symm-Clashes
2	F	401	PTY	7	0
3	E	403	3PE	5	0
3	F	403	3PE	5	0
2	E	402	PTY	7	0
5	E	404	CLR	3	0
2	B	401	PTY	7	0
2	B	402	PTY	7	0
2	G	401	PTY	7	0
5	D	405	CLR	2	0
5	G	405	CLR	2	0
5	C	405	CLR	2	0
4	E	406	DGA	2	0
5	A	406	CLR	2	0
5	D	404	CLR	4	0

The following is a two-dimensional graphical depiction of Mogul quality analysis of bond lengths, bond angles, torsion angles, and ring geometry for all instances of the Ligand of Interest. In addition, ligands with molecular weight > 250 and outliers as shown on the validation Tables will also be included. For torsion angles, if less than 5% of the Mogul distribution of torsion angles is within 10 degrees of the torsion angle in question, then that torsion angle is considered an outlier. Any bond that is central to one or more torsion angles identified as an outlier by Mogul will be highlighted in the graph. For rings, the root-mean-square deviation (RMSD) between the ring in question and similar rings identified by Mogul is calculated over all ring torsion angles. If the average RMSD is greater than 60 degrees and the minimal RMSD between the ring in question and any Mogul-identified rings is also greater than 60 degrees, then that ring is considered an outlier. The outliers are highlighted in purple. The color gray indicates Mogul did not find sufficient equivalents in the CSD to analyse the geometry.

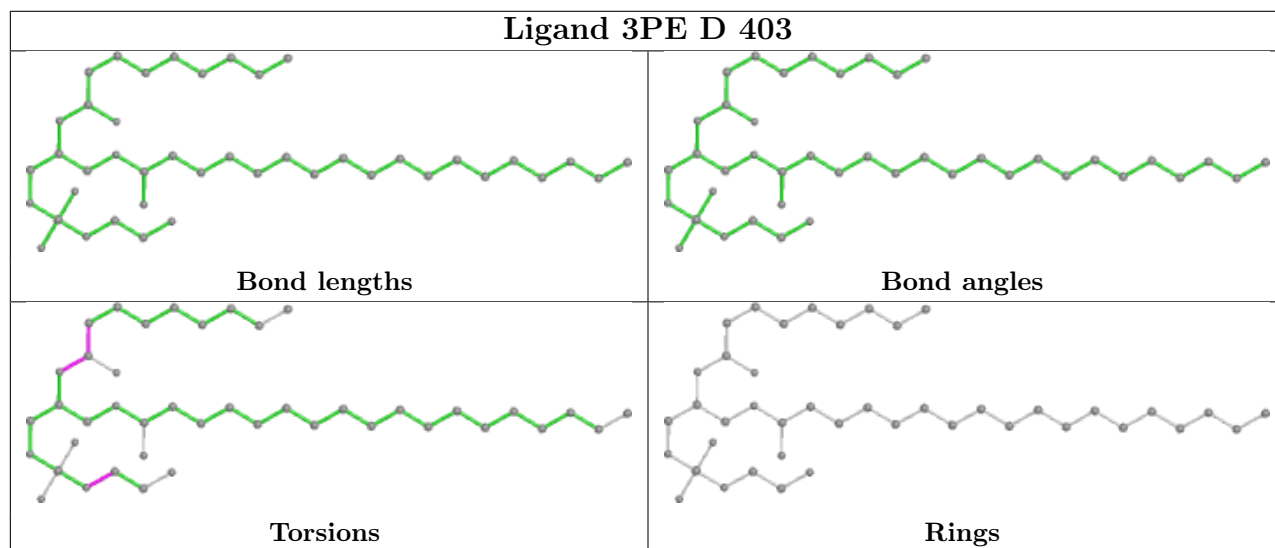

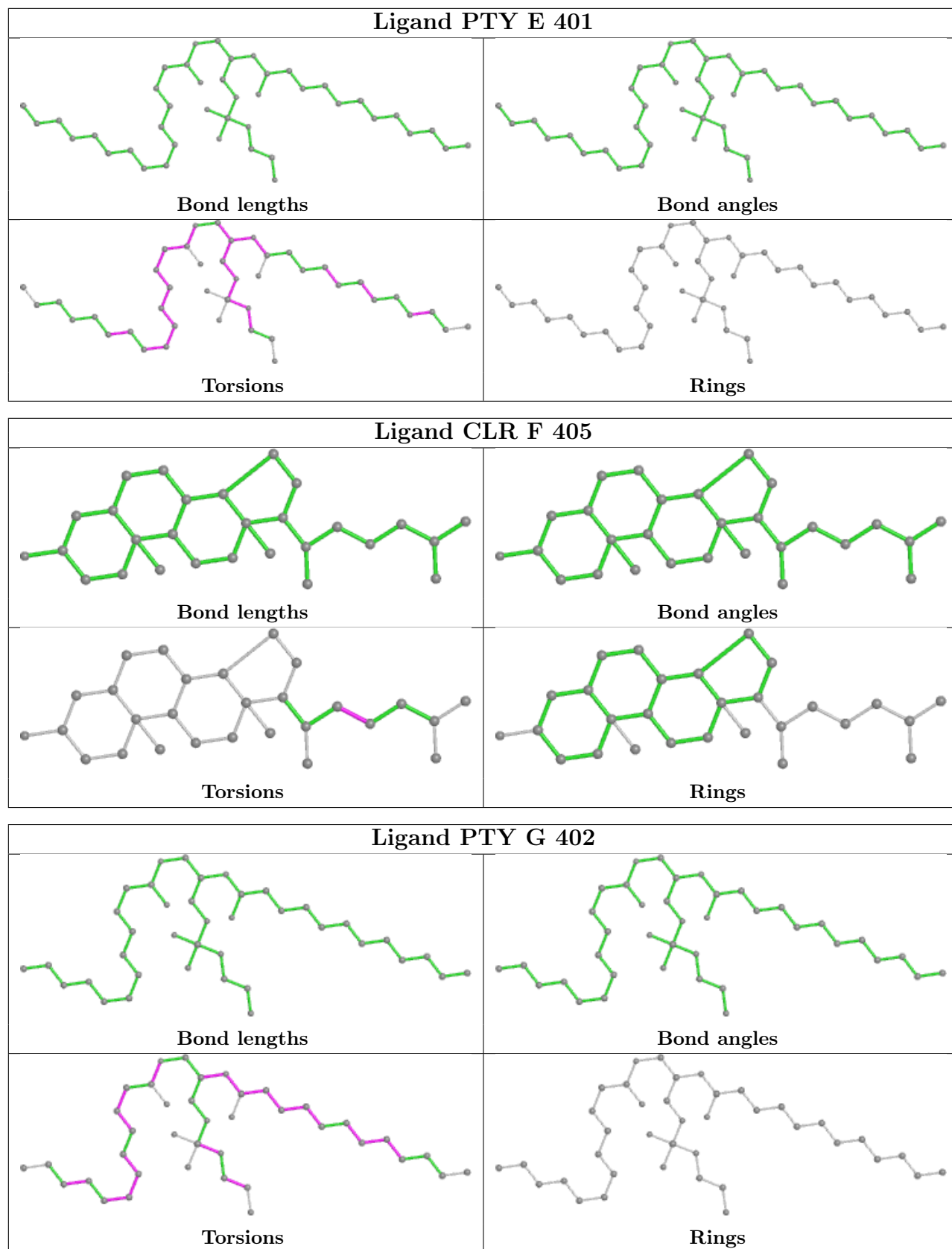

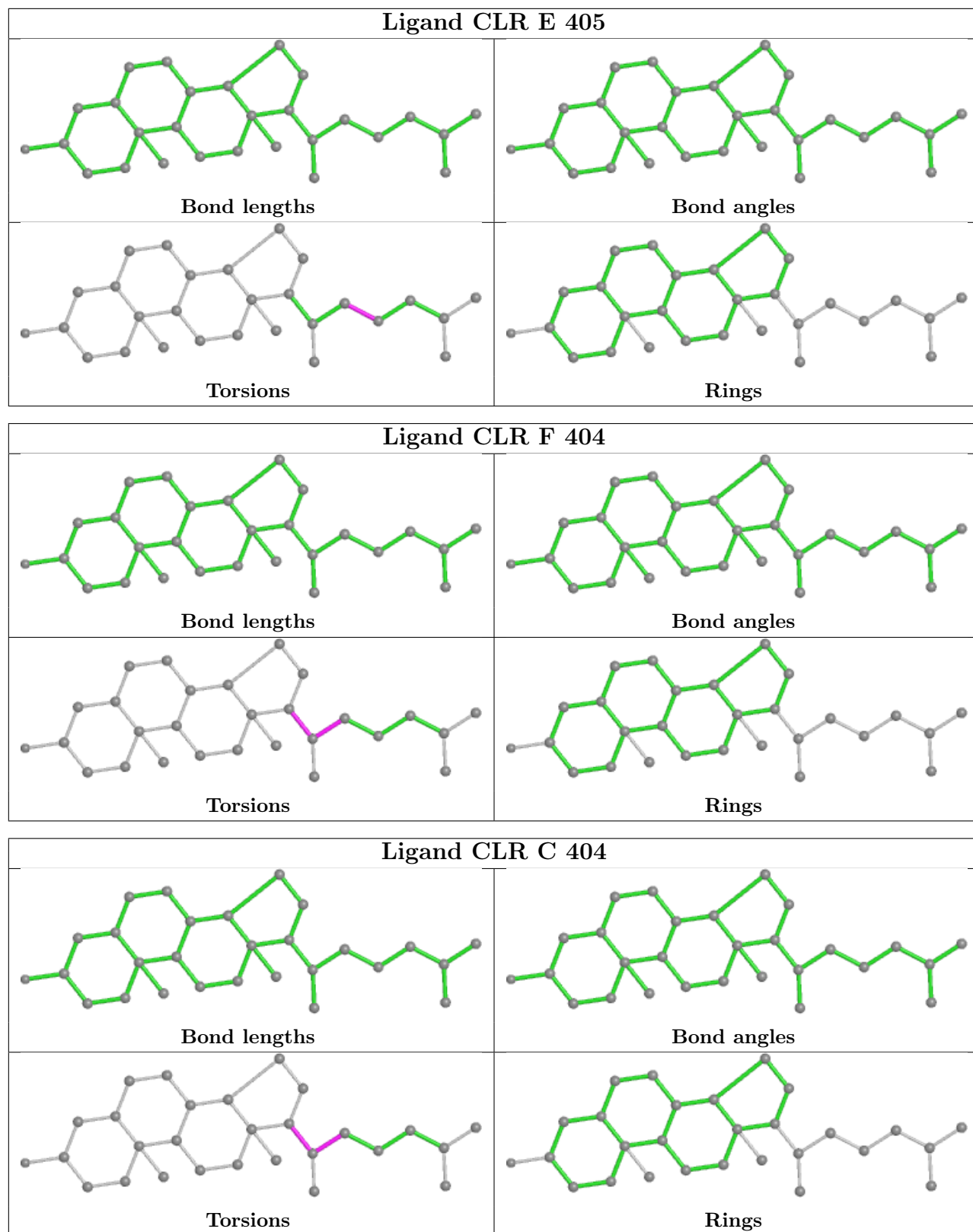

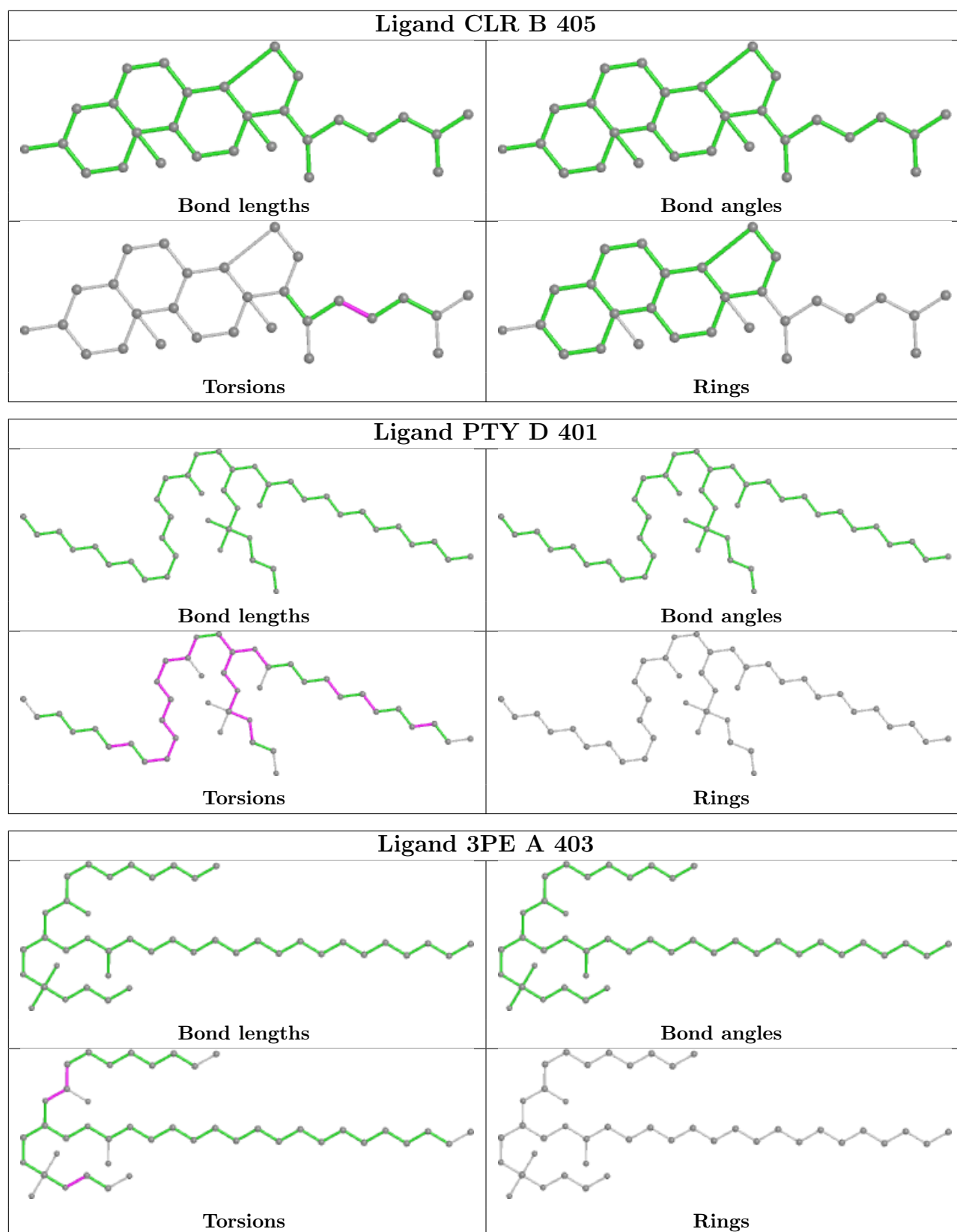

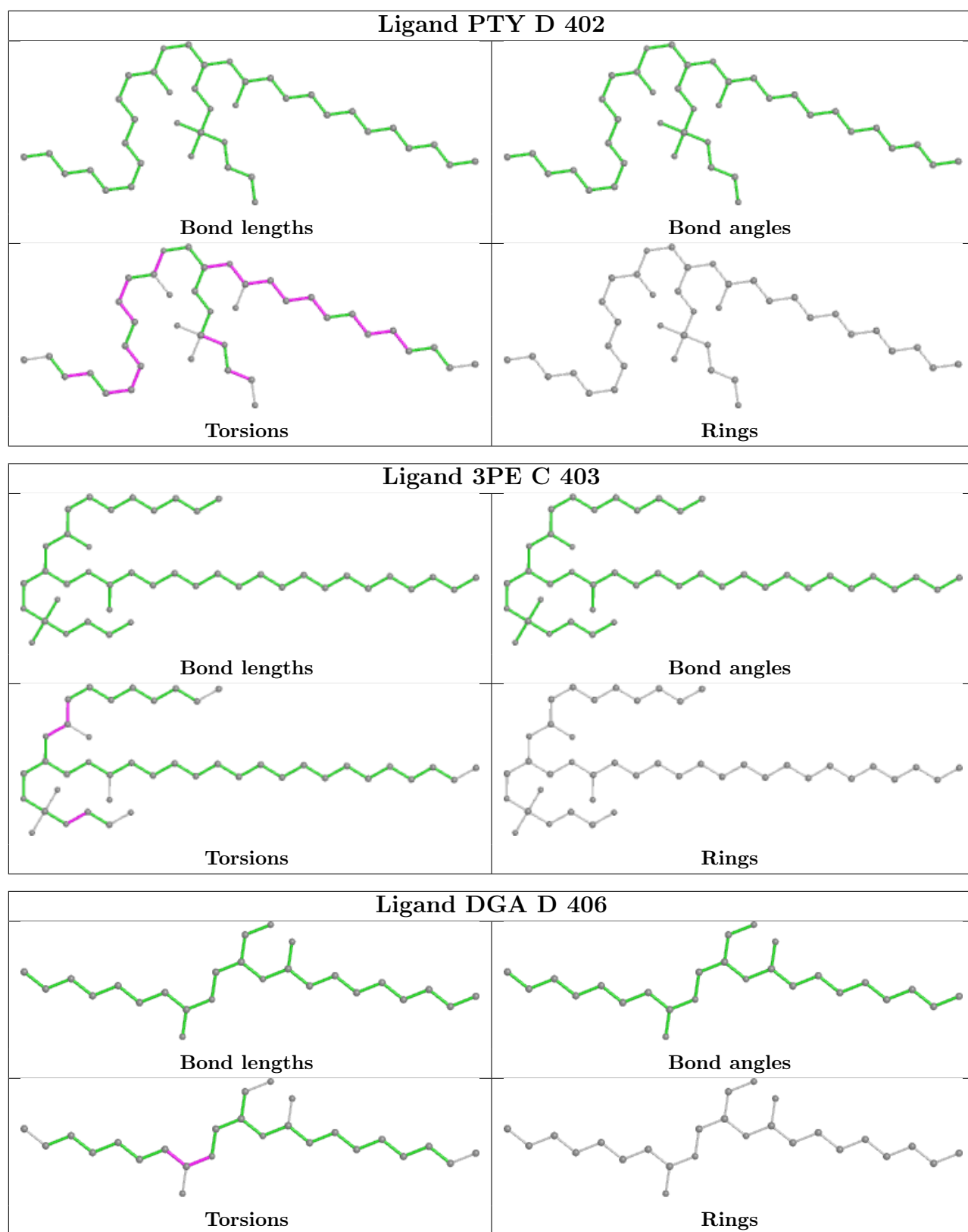

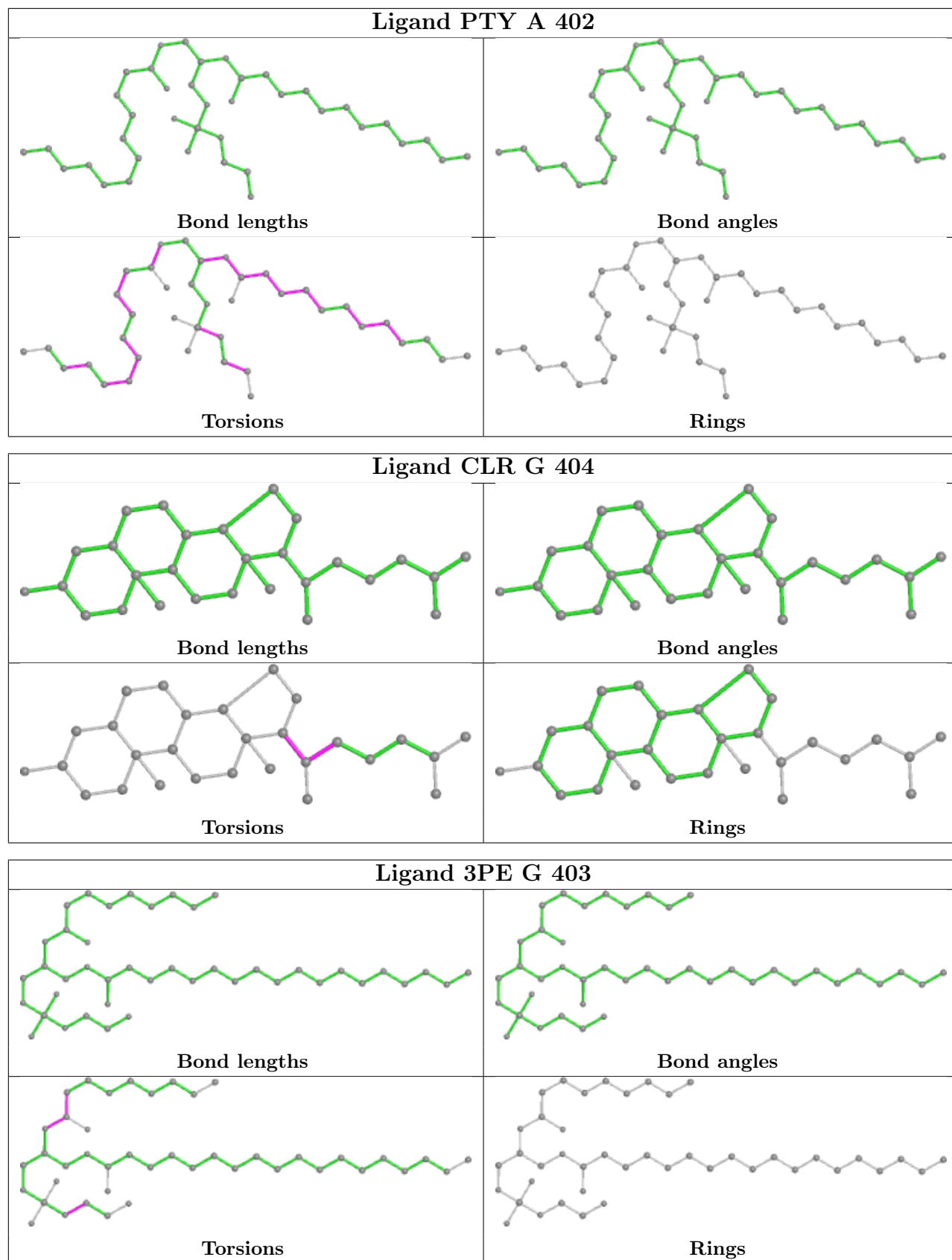

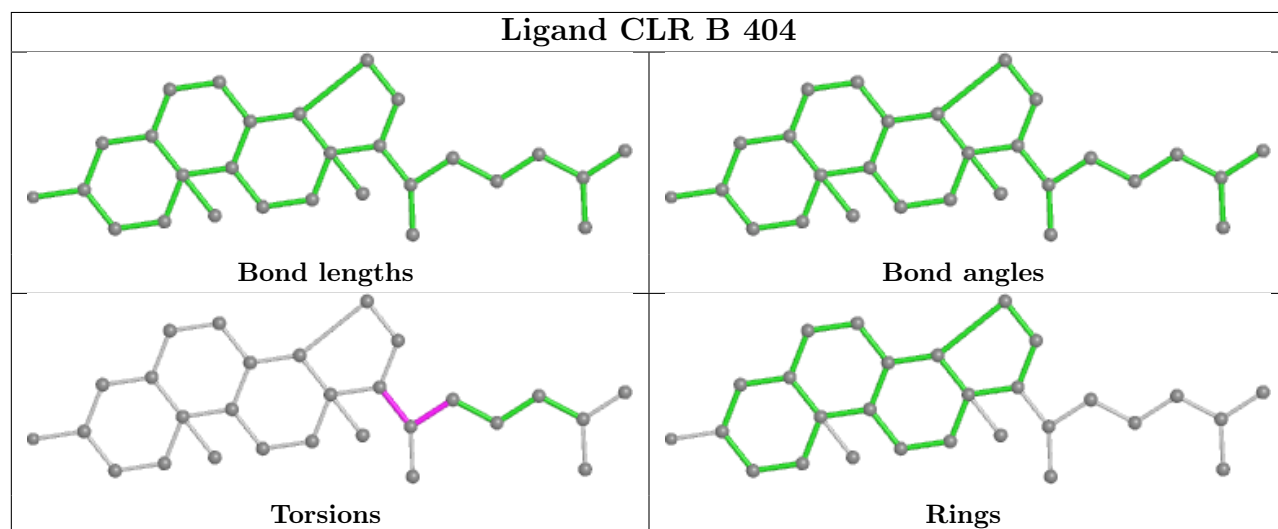
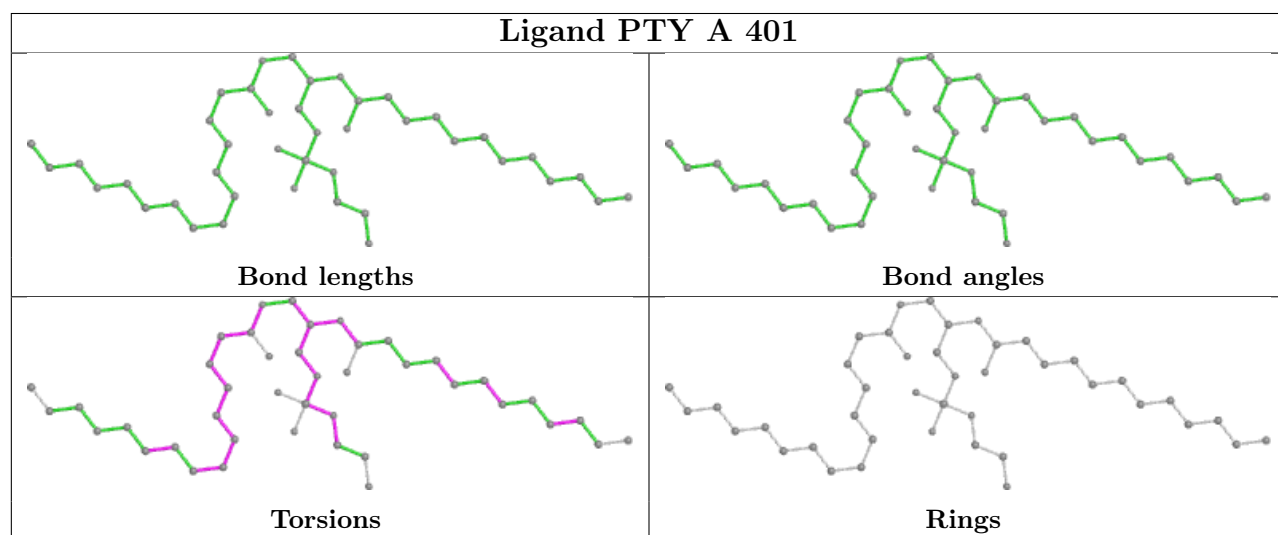
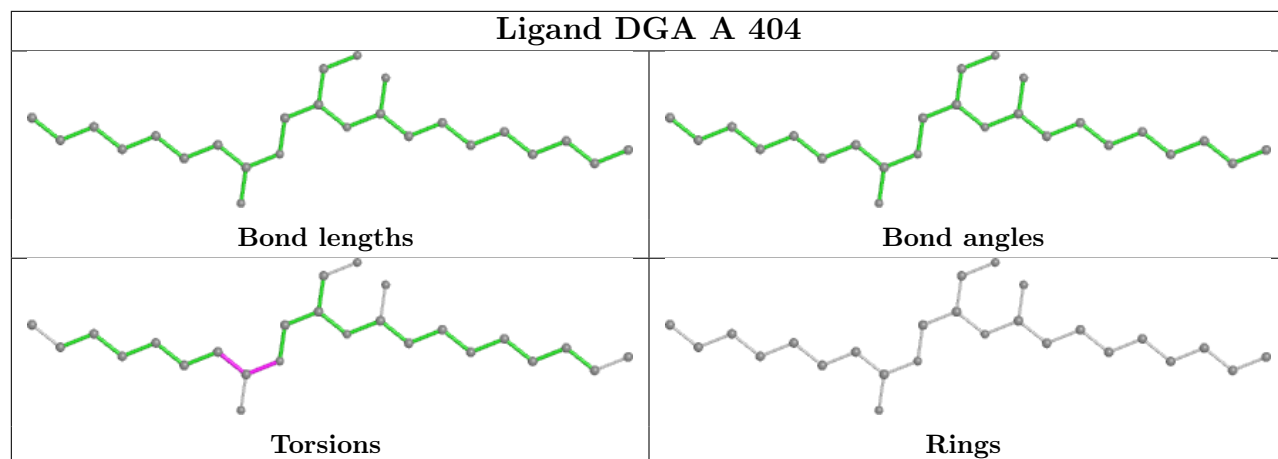

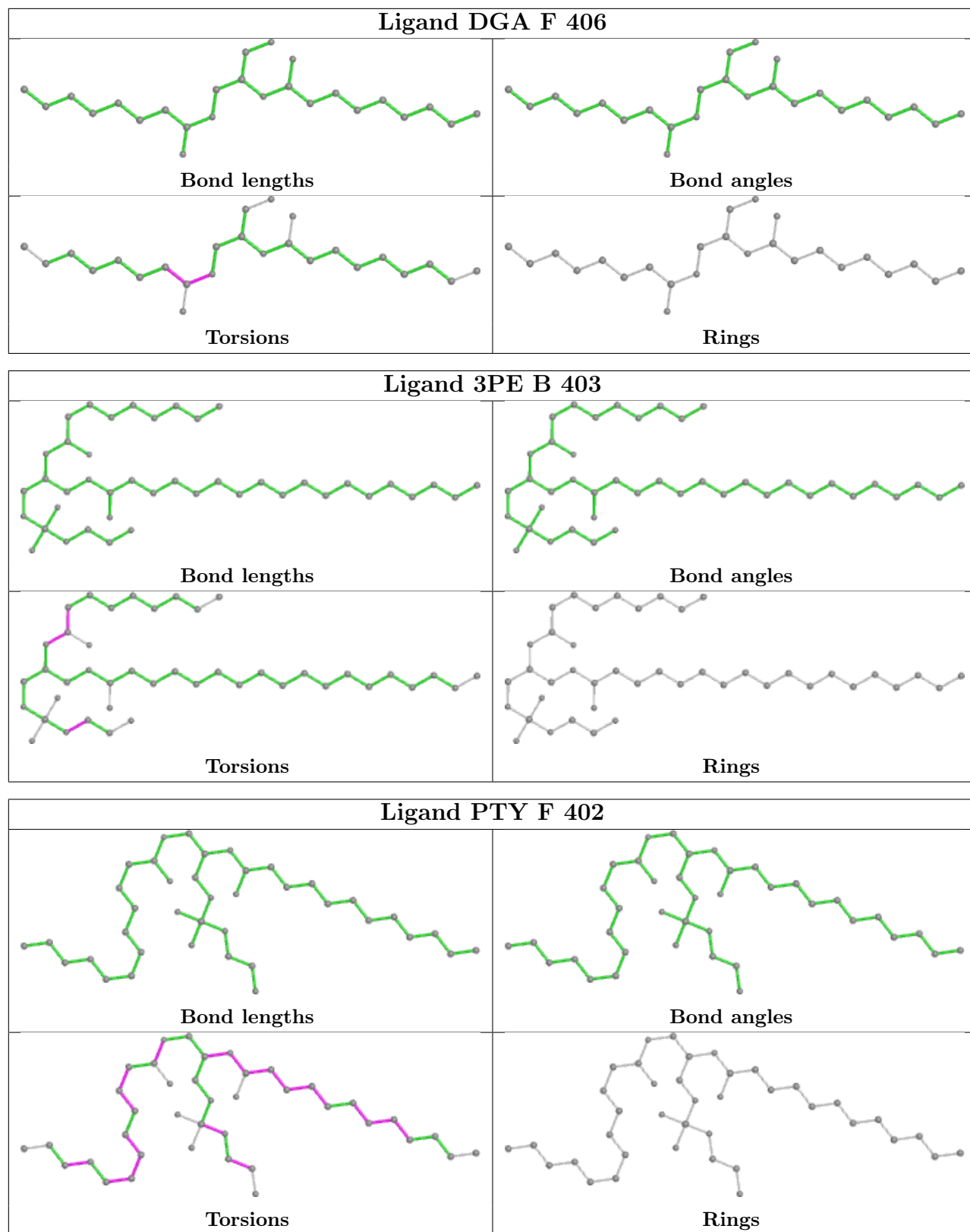

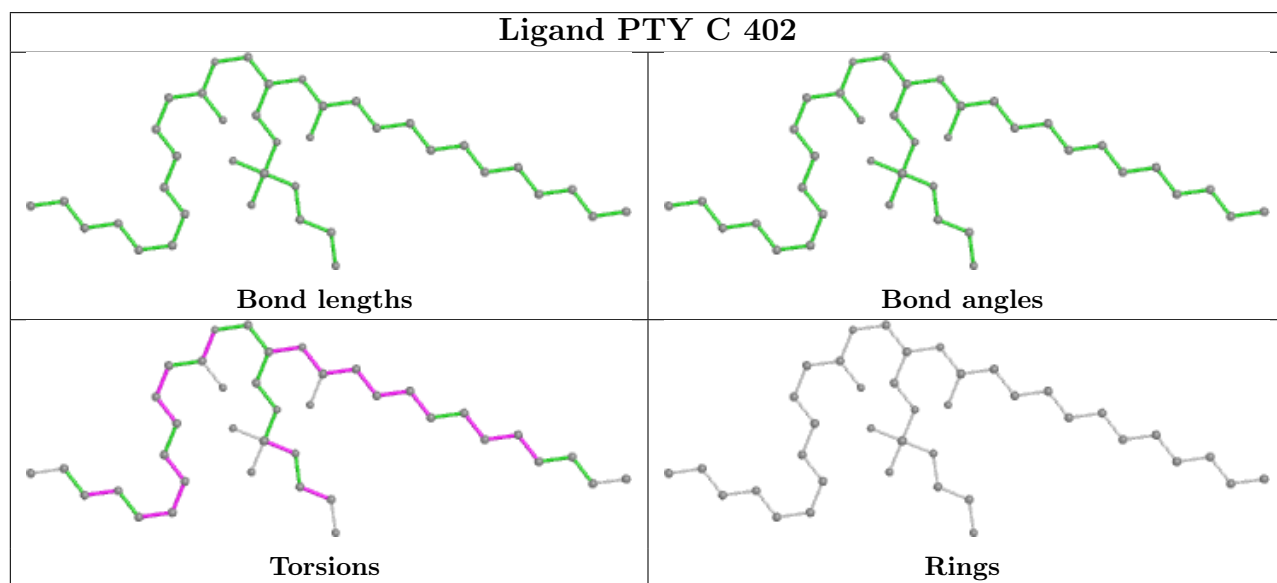
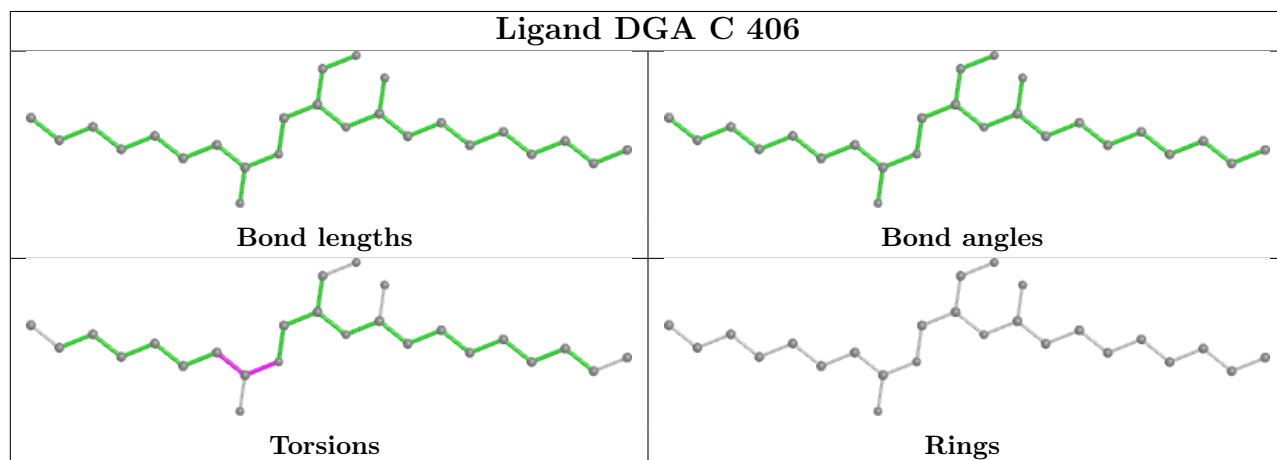
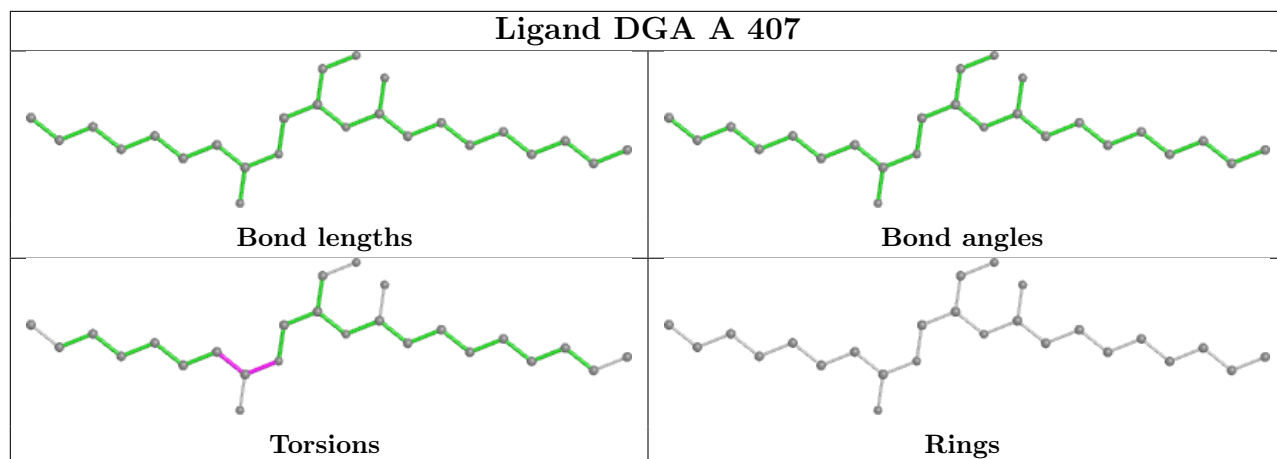

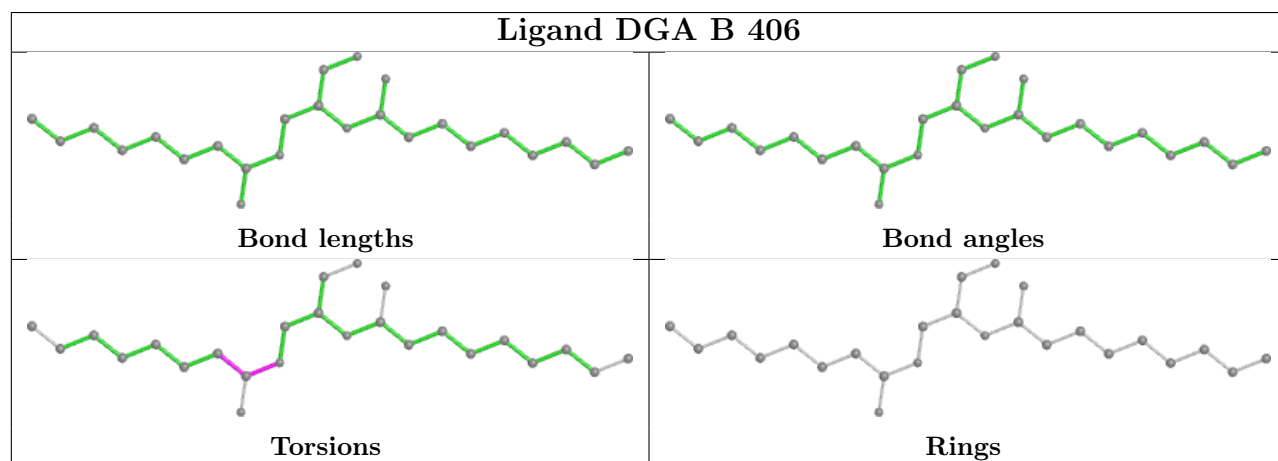
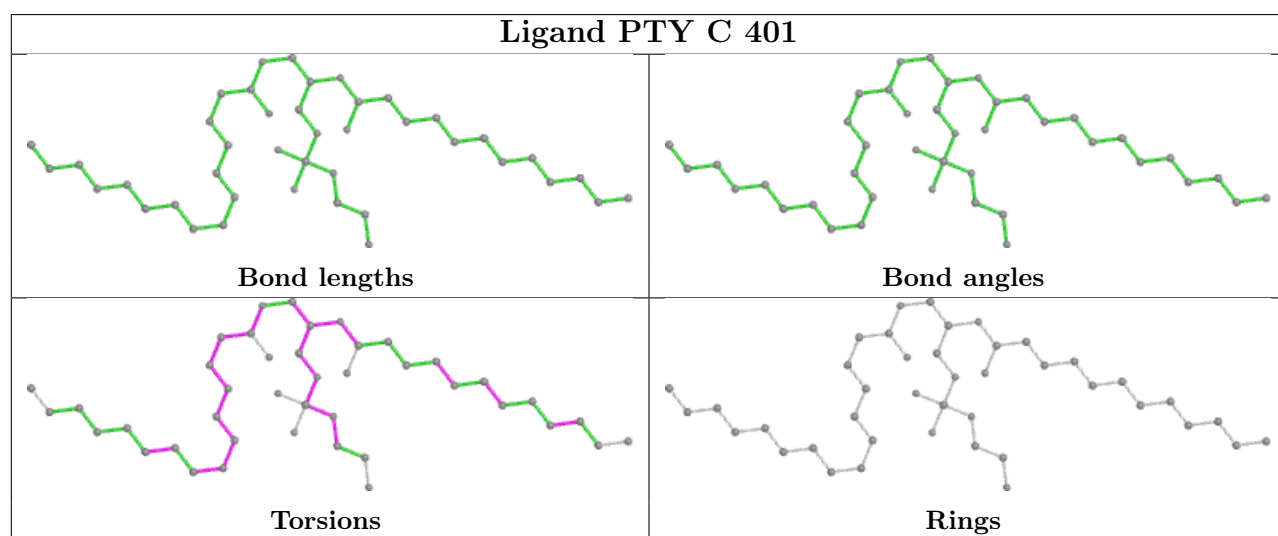
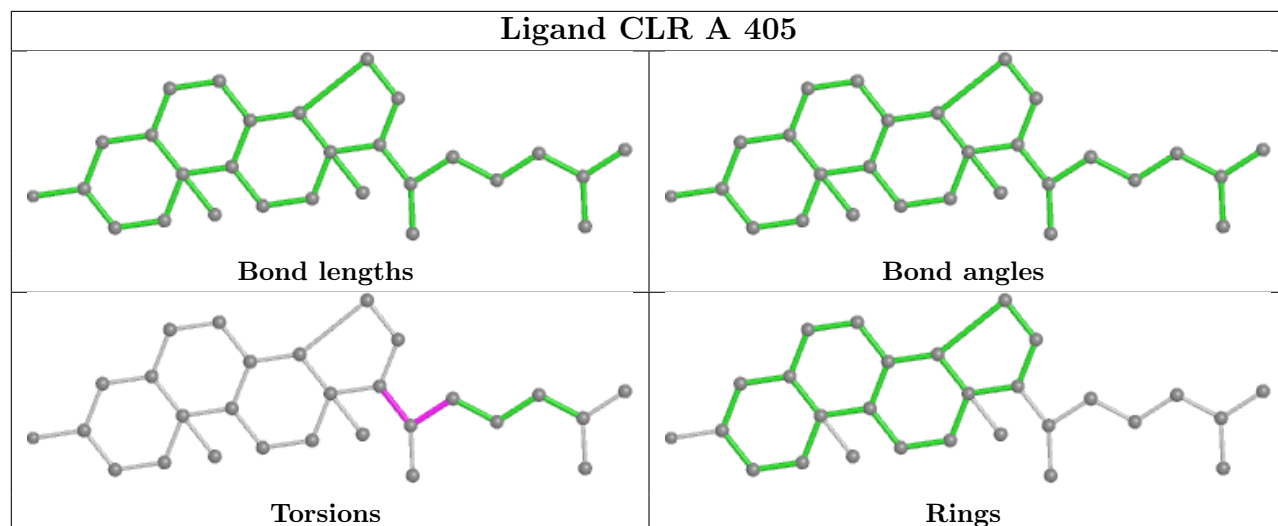

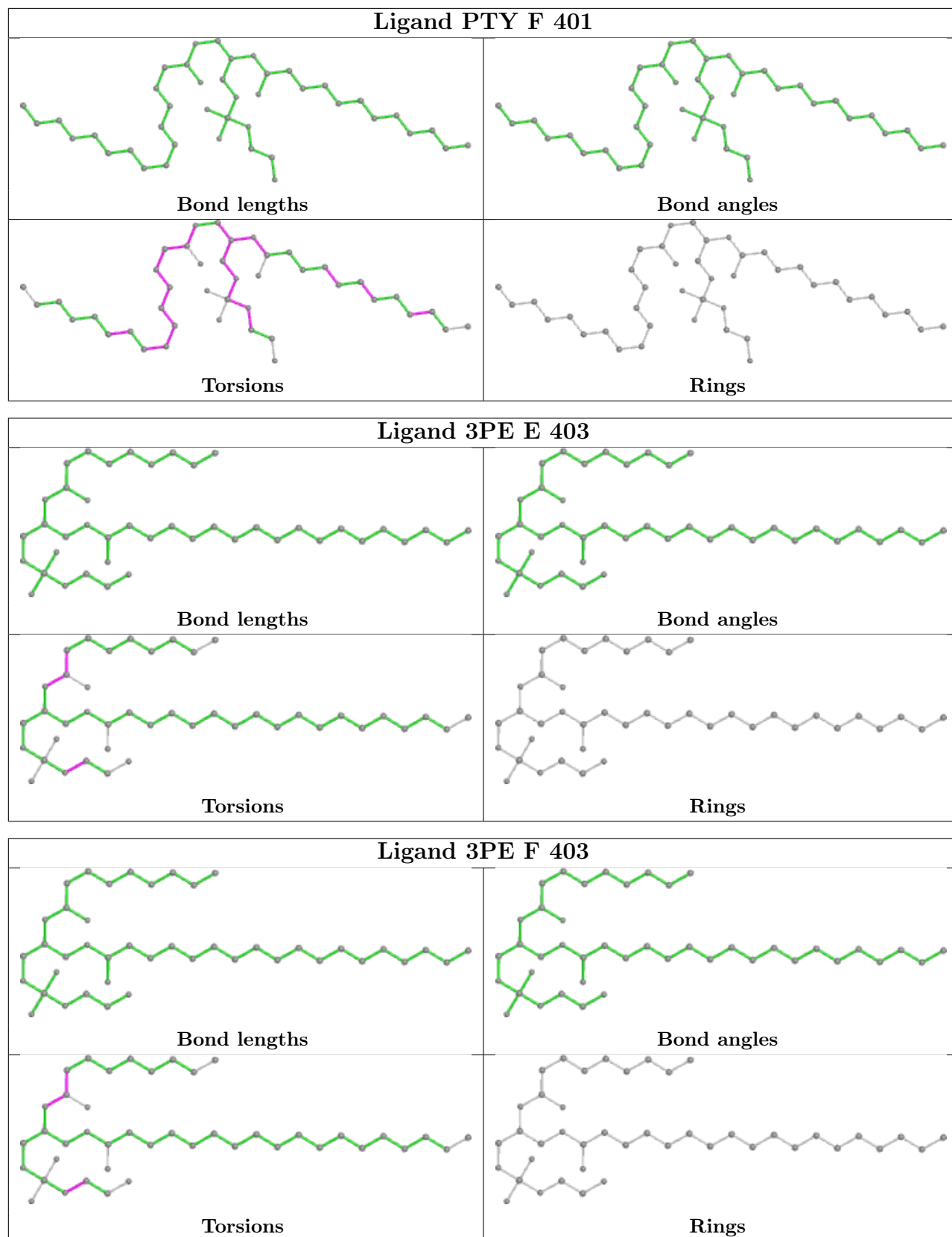

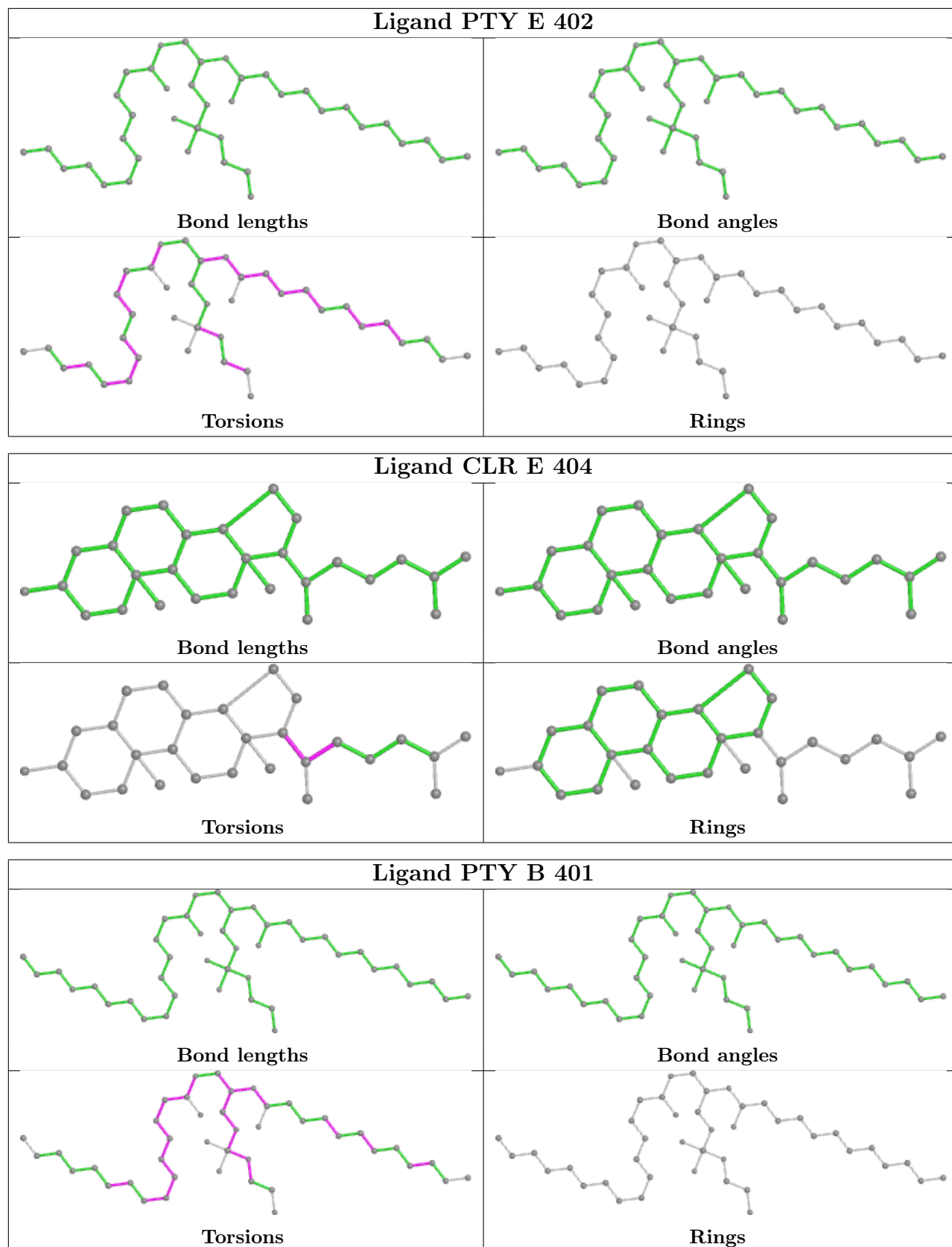

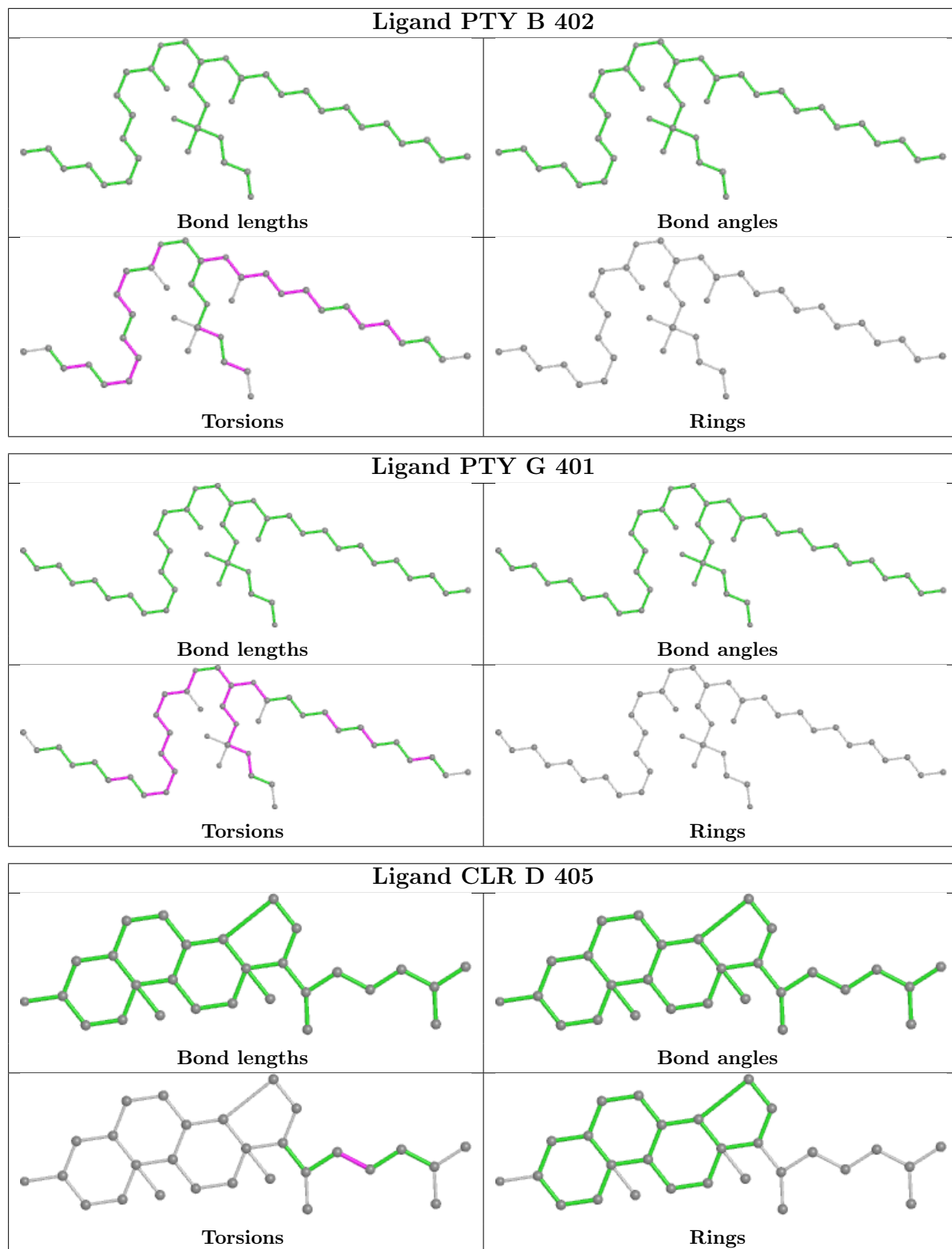

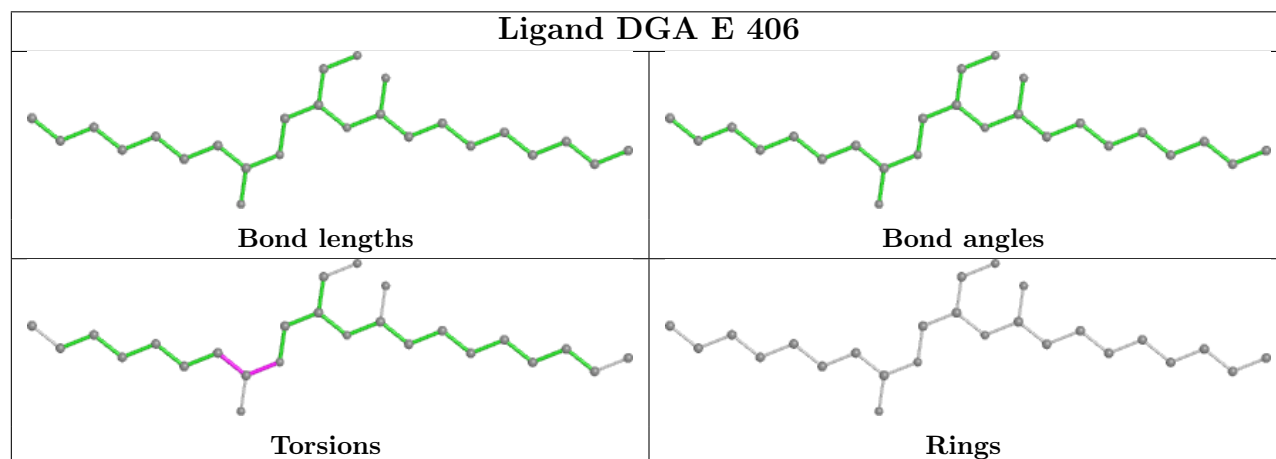
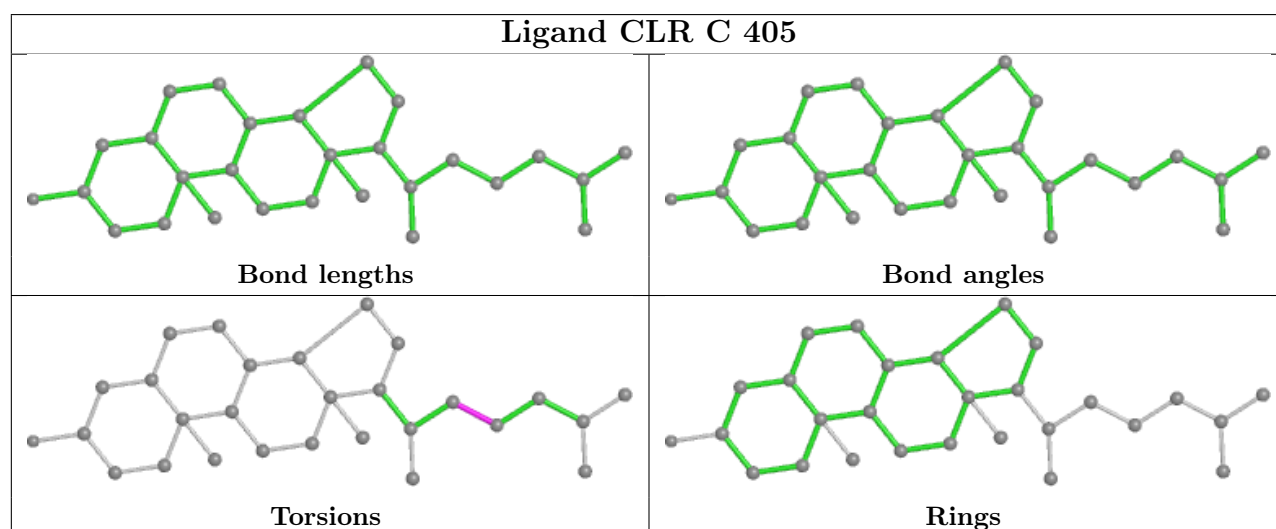
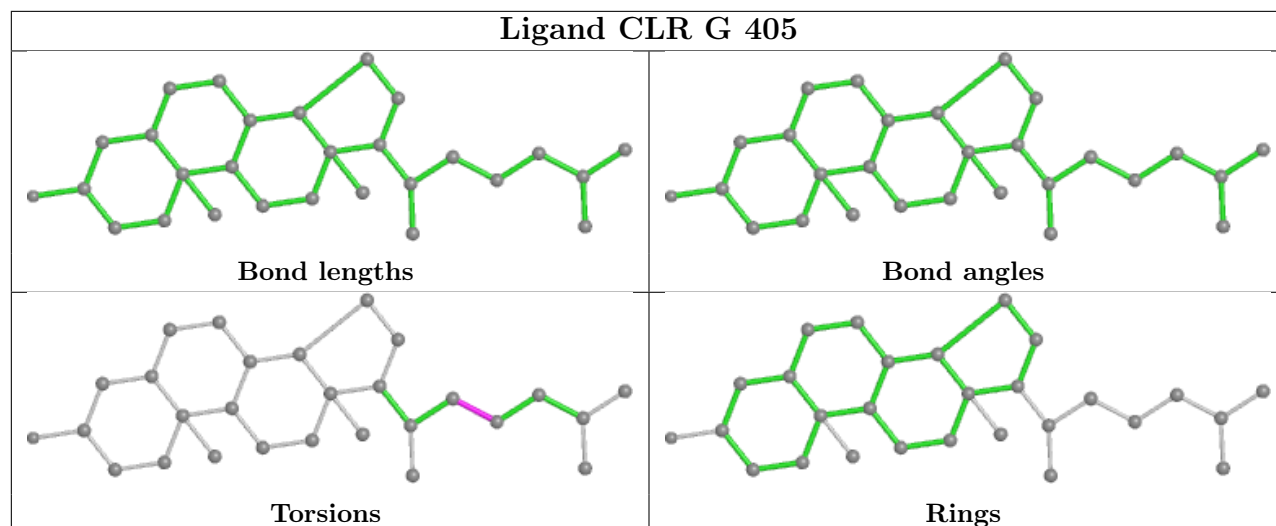

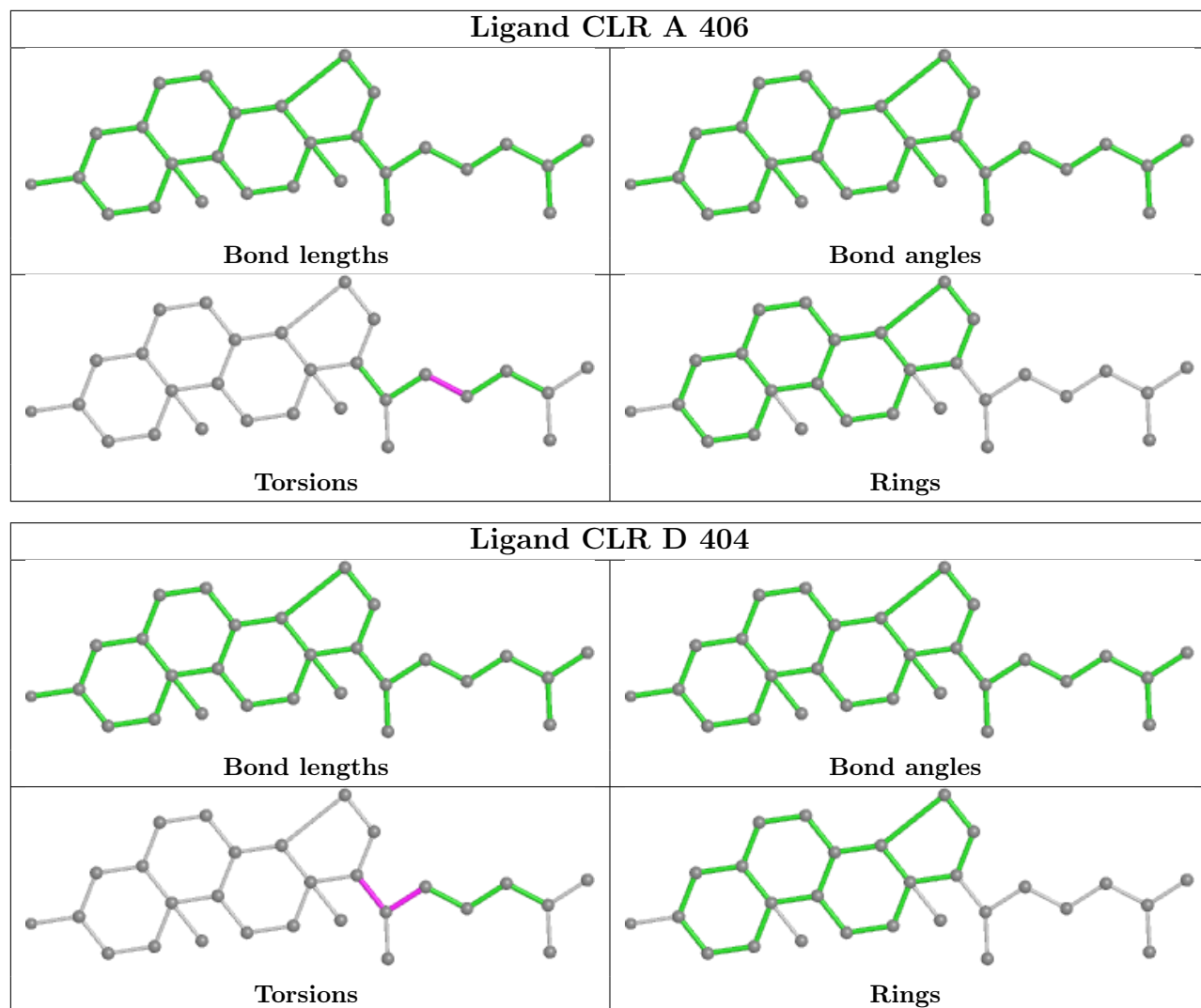

5.7 Other polymers [i](#)

There are no such residues in this entry.

5.8 Polymer linkage issues [i](#)

There are no chain breaks in this entry.

6 Map visualisation [i](#)

This section contains visualisations of the EMDB entry EMD-21593. These allow visual inspection of the internal detail of the map and identification of artifacts.

No raw map or half-maps were deposited for this entry and therefore no images, graphs, etc. pertaining to the raw map can be shown.

6.1 Orthogonal projections [i](#)

6.1.1 Primary map

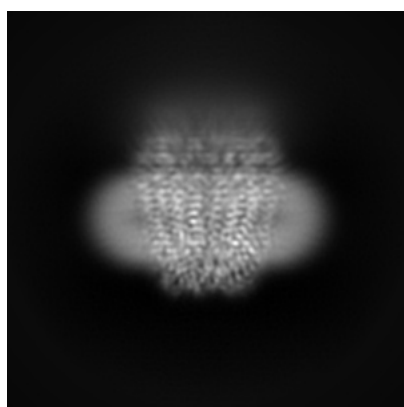

X

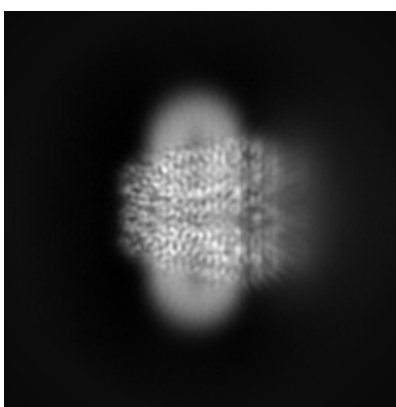

Y

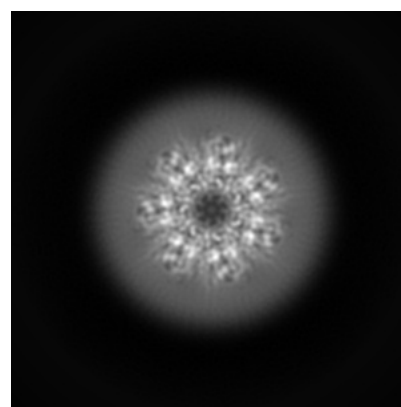

Z

The images above show the map projected in three orthogonal directions.

6.2 Central slices [i](#)

6.2.1 Primary map

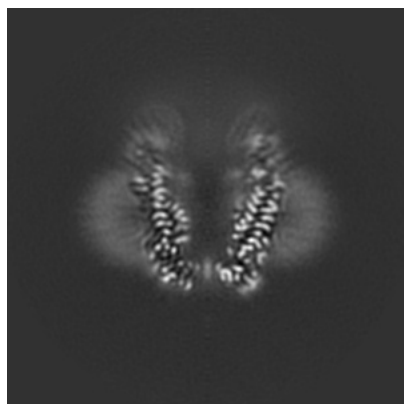

X Index: 150

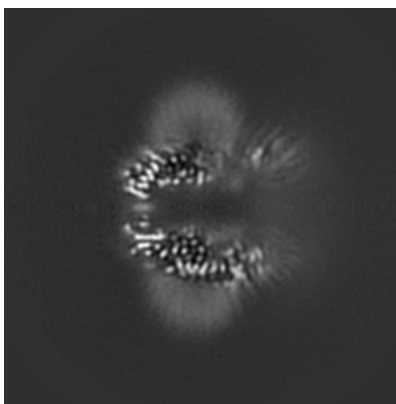

Y Index: 150

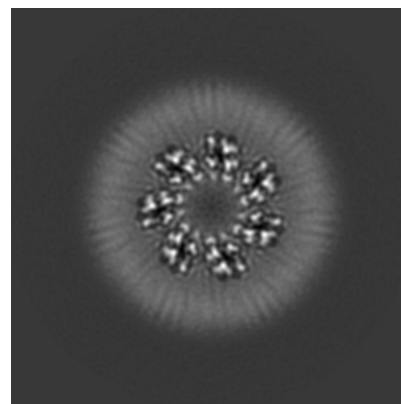

Z Index: 150

The images above show central slices of the map in three orthogonal directions.

6.3 Largest variance slices [i](#)

6.3.1 Primary map

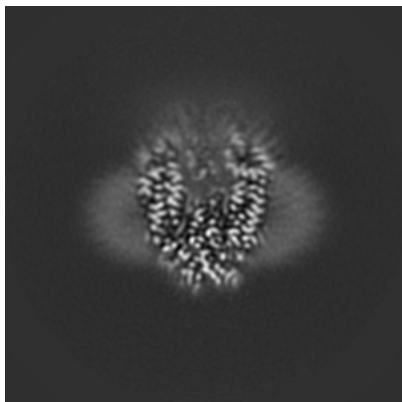

X Index: 121

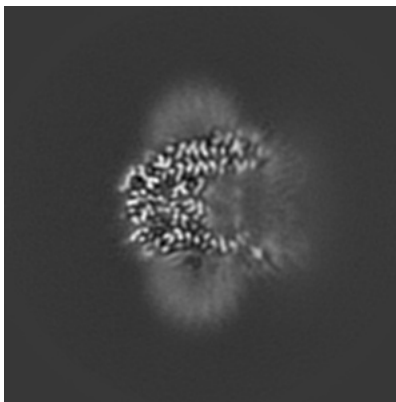

Y Index: 130

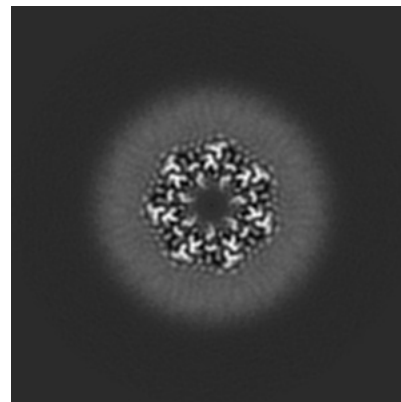

Z Index: 125

The images above show the largest variance slices of the map in three orthogonal directions.

6.4 Orthogonal surface views [i](#)

6.4.1 Primary map

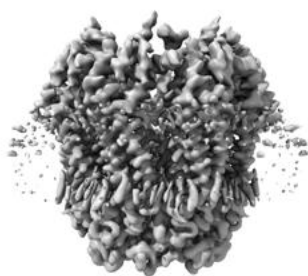

X

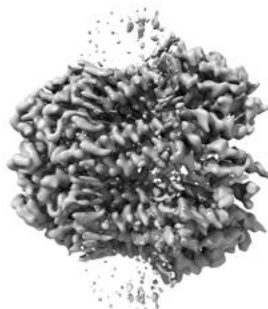

Y

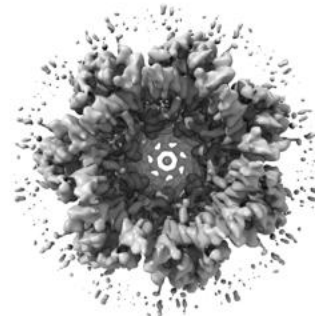

Z

The images above show the 3D surface view of the map at the recommended contour level 0.0075. These images, in conjunction with the slice images, may facilitate assessment of whether an appropriate contour level has been provided.

6.5 Mask visualisation

This section was not generated. No masks/segmentation were deposited.

7 Map analysis [i](#)

This section contains the results of statistical analysis of the map.

7.1 Map-value distribution [i](#)

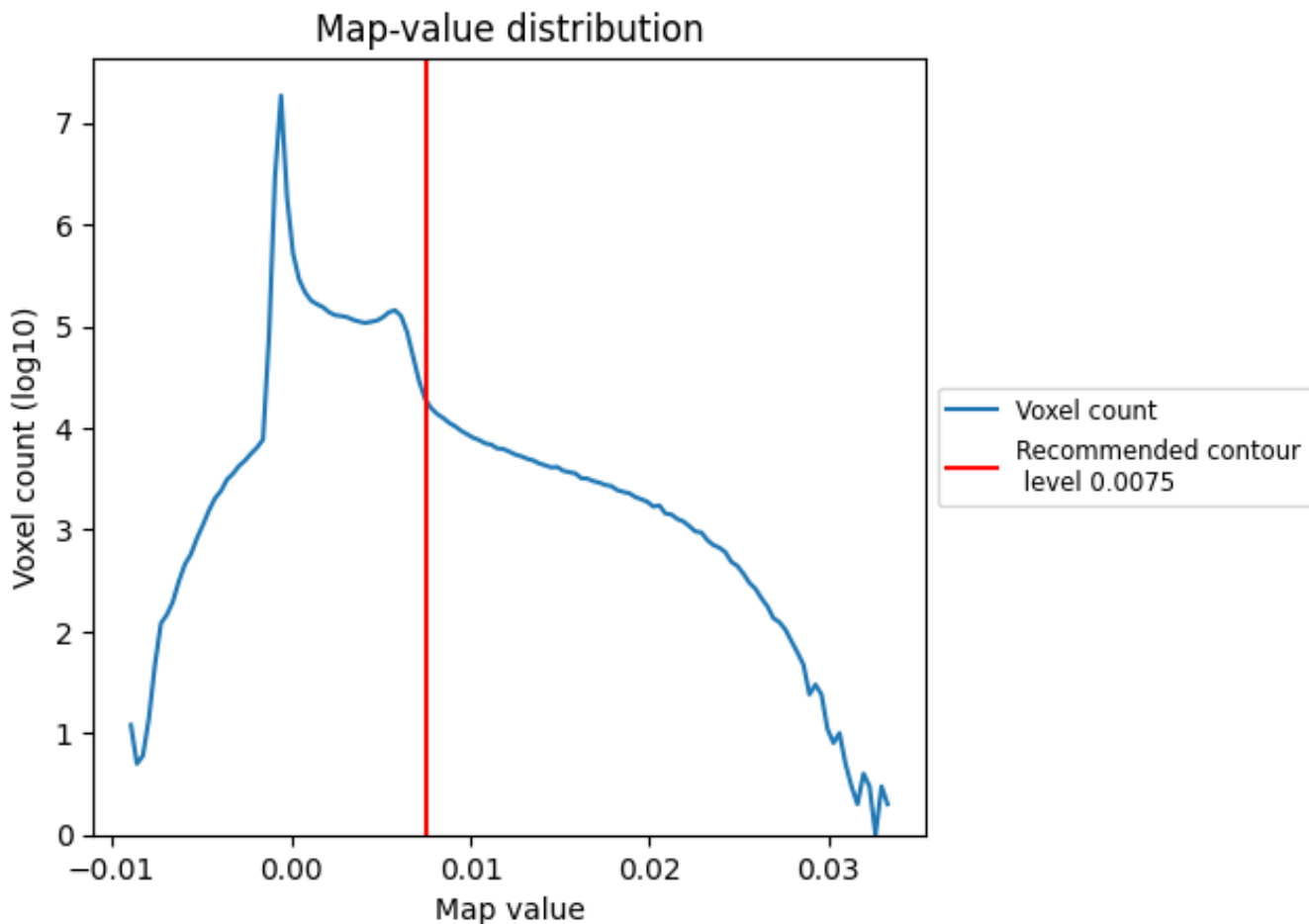

The map-value distribution is plotted in 128 intervals along the x-axis. The y-axis is logarithmic. A spike in this graph at zero usually indicates that the volume has been masked.

7.2 Volume estimate [i](#)

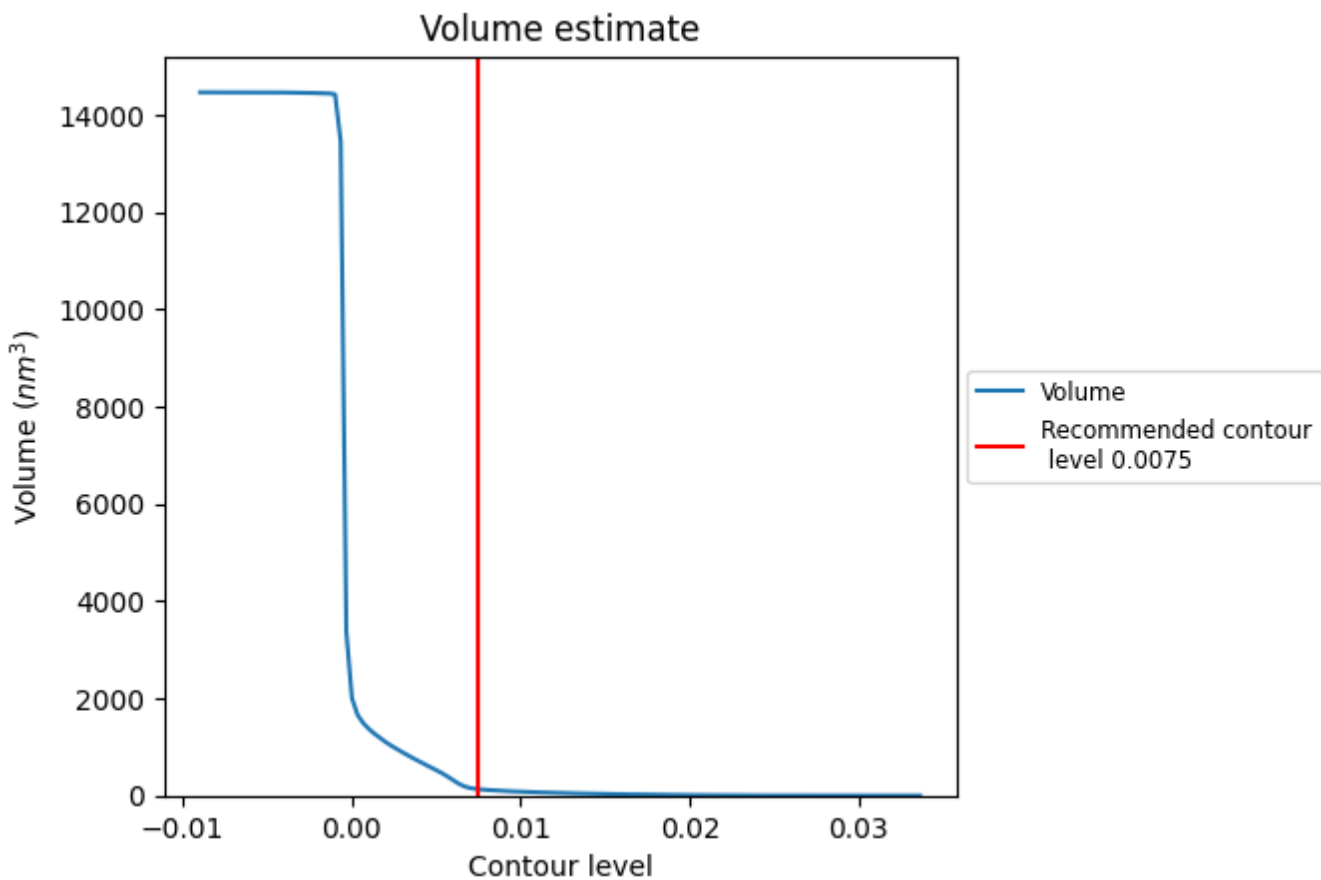

The volume at the recommended contour level is 131 nm³; this corresponds to an approximate mass of 118 kDa.

The volume estimate graph shows how the enclosed volume varies with the contour level. The recommended contour level is shown as a vertical line and the intersection between the line and the curve gives the volume of the enclosed surface at the given level.

7.3 Rotationally averaged power spectrum [i](#)

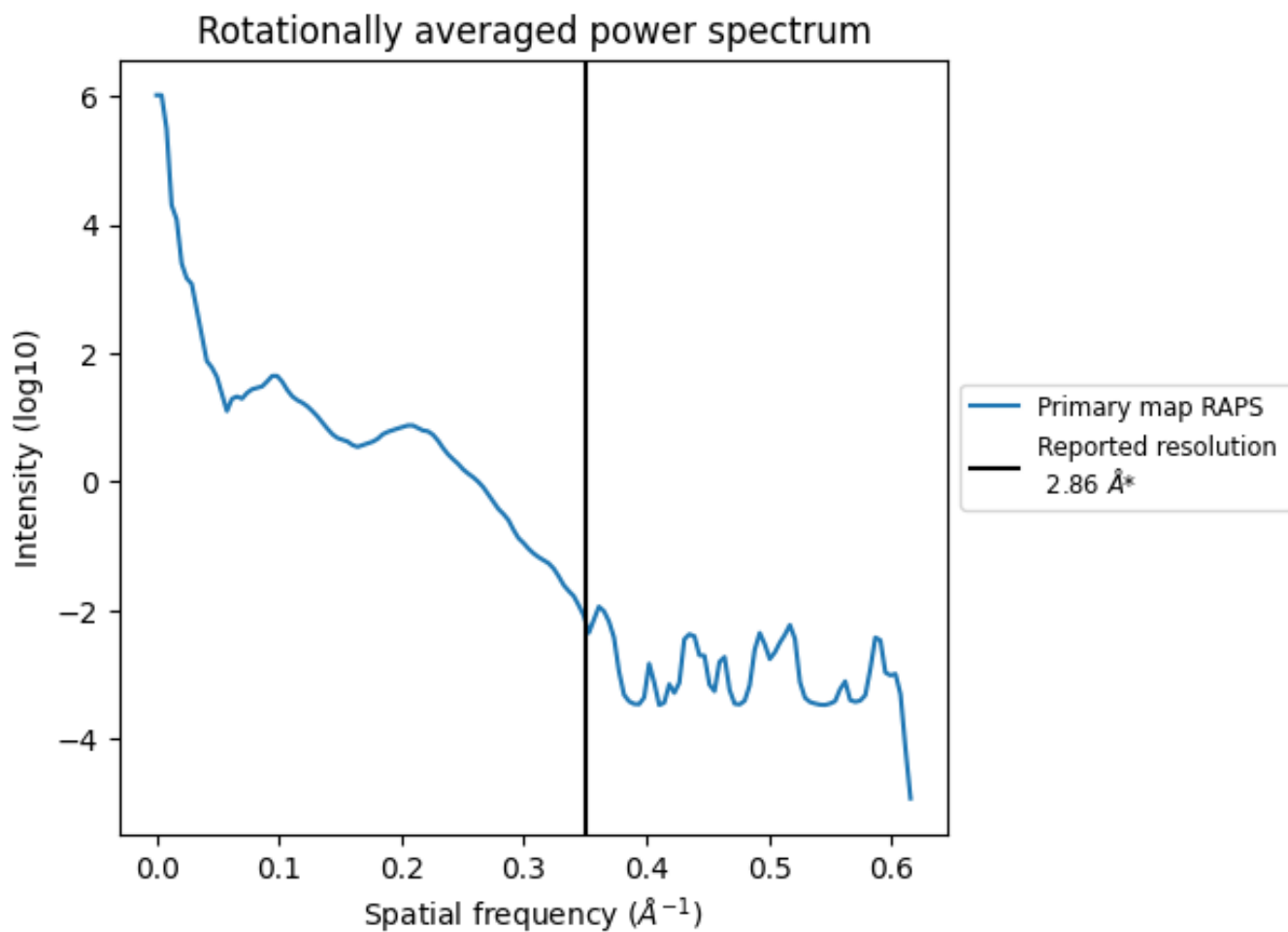

*Reported resolution corresponds to spatial frequency of 0.350\AA^{-1}

8 Fourier-Shell correlation

This section was not generated. No FSC curve or half-maps provided.

9 Map-model fit [i](#)

This section contains information regarding the fit between EMDB map EMD-21593 and PDB model 6WBM. Per-residue inclusion information can be found in section 3 on page 8.

9.1 Map-model overlay [i](#)

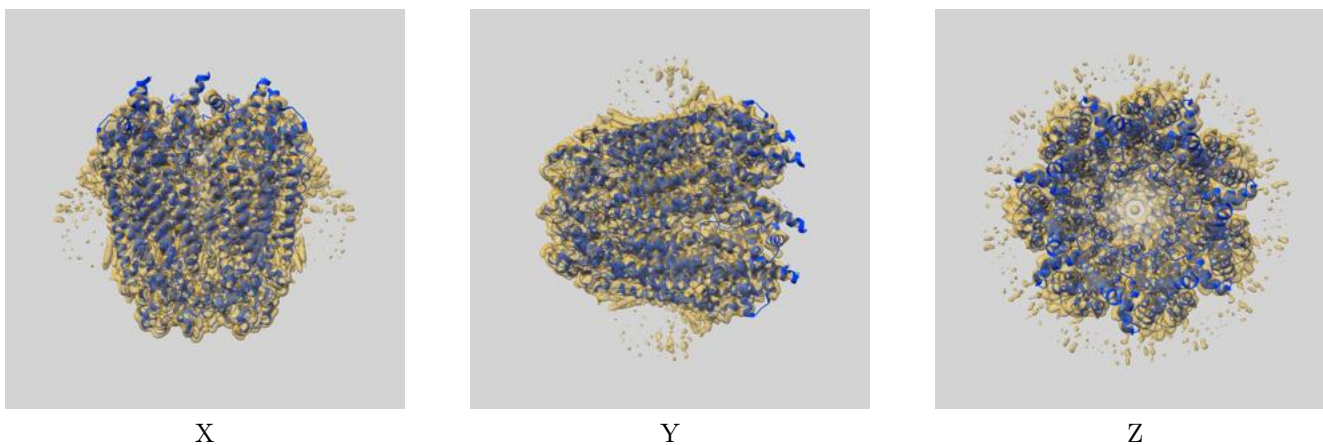

The images above show the 3D surface view of the map at the recommended contour level 0.0075 at 50% transparency in yellow overlaid with a ribbon representation of the model coloured in blue. These images allow for the visual assessment of the quality of fit between the atomic model and the map.

9.2 Q-score mapped to coordinate model [i](#)

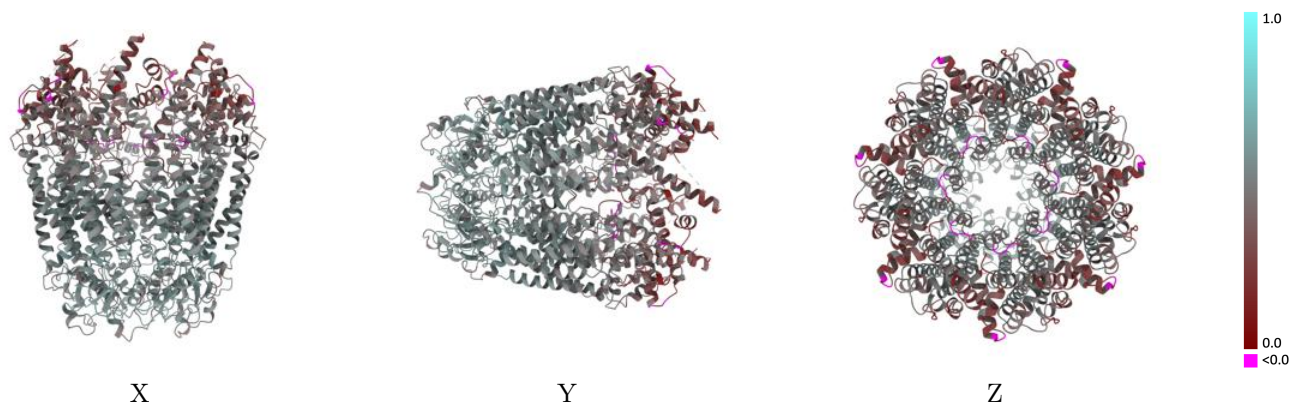

The images above show the model with each residue coloured according to its Q-score. This shows their resolvability in the map with higher Q-score values reflecting better resolvability. Please note: Q-score is calculating the resolvability of atoms, and thus high values are only expected at resolutions at which atoms can be resolved. Low Q-score values may therefore be expected for many entries.

9.3 Atom inclusion mapped to coordinate model [i](#)

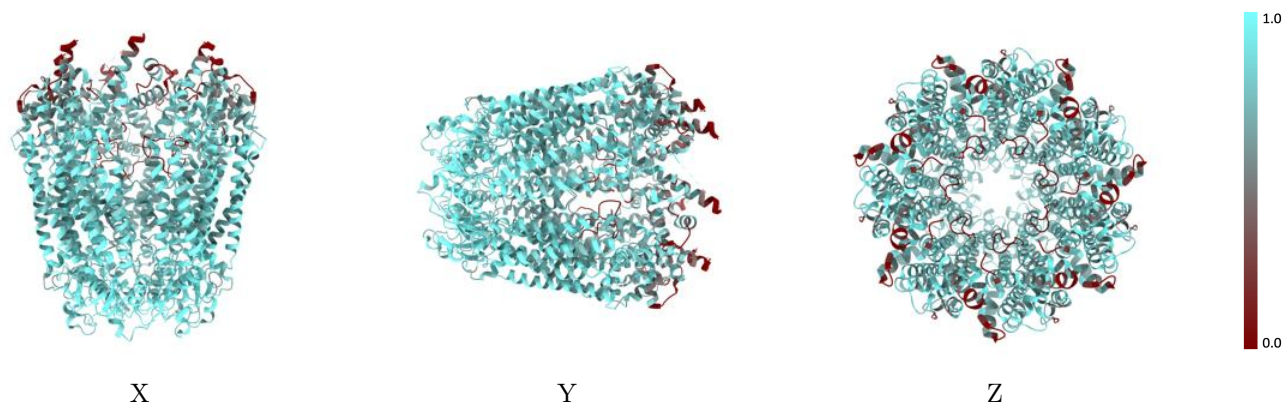

The images above show the model with each residue coloured according to its atom inclusion. This shows to what extent they are inside the map at the recommended contour level (0.0075).



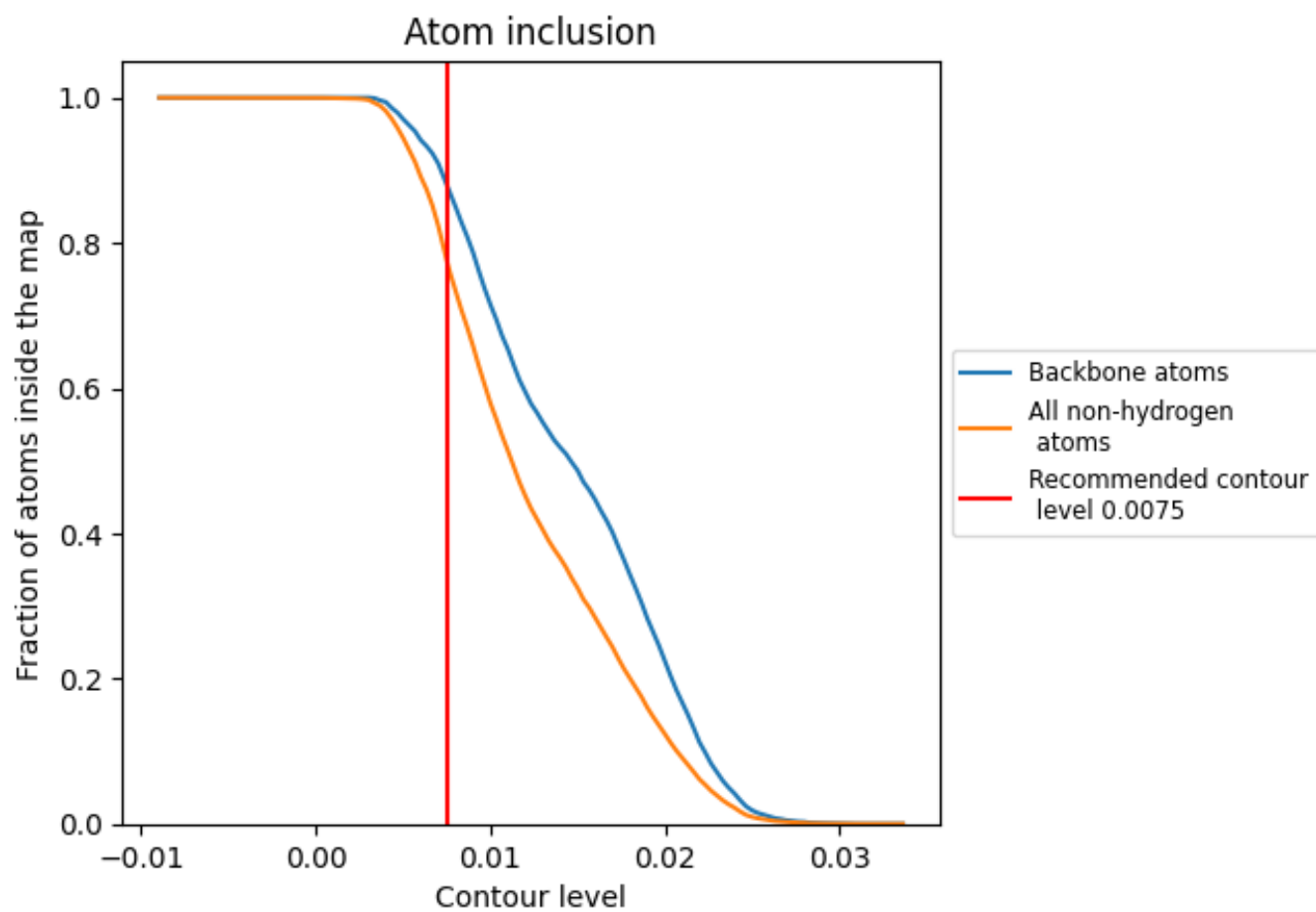













9.4 Atom inclusion [i](#)



At the recommended contour level, 88% of all backbone atoms, 78% of all non-hydrogen atoms, are inside the map.

9.5 Map-model fit summary

The table lists the average atom inclusion at the recommended contour level (0.0075) and Q-score for the entire model and for each chain.

Chain	Atom inclusion	Q-score
All	 0.7763	 0.4700
A	 0.7666	 0.4690
B	 0.7773	 0.4710
C	 0.7762	 0.4710
D	 0.7784	 0.4710
E	 0.7777	 0.4700
F	 0.7744	 0.4700
G	 0.7835	 0.4700

