



Full wwPDB X-ray Structure Validation Report ⓘ

Oct 4, 2023 – 09:57 AM EDT

PDB ID : 6UG0
Title : N2-bound Nitrogenase MoFe-protein from *Azotobacter vinelandii*
Authors : Kang, W.; Hu, Y.; Ribbe, M.W.
Deposited on : 2019-09-25
Resolution : 1.83 Å(reported)

This is a Full wwPDB X-ray Structure Validation Report for a publicly released PDB entry.

We welcome your comments at validation@mail.wwpdb.org

A user guide is available at

<https://www.wwpdb.org/validation/2017/XrayValidationReportHelp>

with specific help available everywhere you see the ⓘ symbol.

The types of validation reports are described at

<http://www.wwpdb.org/validation/2017/FAQs#types>.

The following versions of software and data (see [references ⓘ](#)) were used in the production of this report:

MolProbity : 4.02b-467
Mogul : 1.8.5 (274361), CSD as541be (2020)
Xtriage (Phenix) : 1.13
EDS : 2.35.1
buster-report : 1.1.7 (2018)
Percentile statistics : 20191225.v01 (using entries in the PDB archive December 25th 2019)
Refmac : 5.8.0158
CCP4 : 7.0.044 (Gargrove)
Ideal geometry (proteins) : Engh & Huber (2001)
Ideal geometry (DNA, RNA) : Parkinson et al. (1996)
Validation Pipeline (wwPDB-VP) : 2.35.1

1 Overall quality at a glance

The following experimental techniques were used to determine the structure:

X-RAY DIFFRACTION

The reported resolution of this entry is 1.83 Å.

Percentile scores (ranging between 0-100) for global validation metrics of the entry are shown in the following graphic. The table shows the number of entries on which the scores are based.

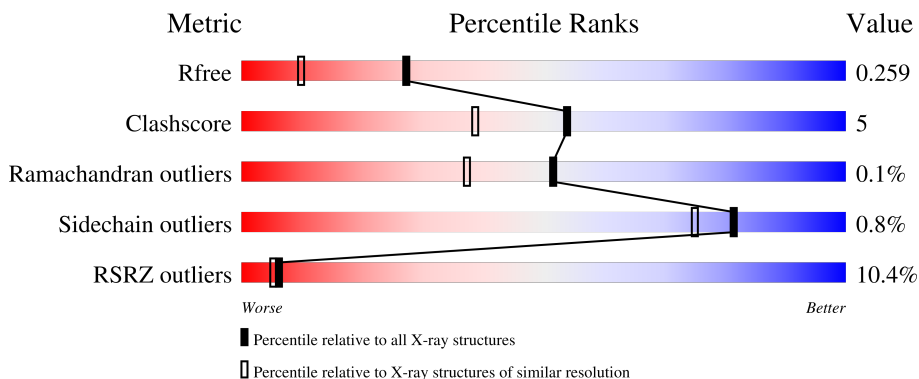

Metric	Whole archive (#Entries)	Similar resolution (#Entries, resolution range(Å))
R_{free}	130704	4003 (1.86-1.82)
Clashscore	141614	4233 (1.86-1.82)
Ramachandran outliers	138981	4185 (1.86-1.82)
Sidechain outliers	138945	4186 (1.86-1.82)
RSRZ outliers	127900	3957 (1.86-1.82)

The table below summarises the geometric issues observed across the polymeric chains and their fit to the electron density. The red, orange, yellow and green segments of the lower bar indicate the fraction of residues that contain outliers for ≥ 3 , 2, 1 and 0 types of geometric quality criteria respectively. A grey segment represents the fraction of residues that are not modelled. The numeric value for each fraction is indicated below the corresponding segment, with a dot representing fractions $\leq 5\%$. The upper red bar (where present) indicates the fraction of residues that have poor fit to the electron density. The numeric value is given above the bar.

Mol	Chain	Length	Quality of chain
1	A	492	
1	C	492	
2	B	523	
2	D	523	

2 Entry composition [i](#)

There are 13 unique types of molecules in this entry. The entry contains 16514 atoms, of which 0 are hydrogens and 0 are deuteriums.

In the tables below, the ZeroOcc column contains the number of atoms modelled with zero occupancy, the AltConf column contains the number of residues with at least one atom in alternate conformation and the Trace column contains the number of residues modelled with at most 2 atoms.

- Molecule 1 is a protein called Nitrogenase molybdenum-iron protein alpha chain.

Mol	Chain	Residues	Atoms					ZeroOcc	AltConf	Trace
			Total	C	N	O	S			
1	A	476	Total 3657	C 2337	N 624	O 673	S 23	2	0	0
1	C	476	Total 3728	C 2374	N 636	O 693	S 25	1	1	0

- Molecule 2 is a protein called Nitrogenase molybdenum-iron protein beta chain.

Mol	Chain	Residues	Atoms					ZeroOcc	AltConf	Trace
			Total	C	N	O	S			
2	B	522	Total 4081	C 2615	N 692	O 747	S 27	1	0	0
2	D	522	Total 4112	C 2629	N 695	O 760	S 28	0	0	0

- Molecule 3 is 3-HYDROXY-3-CARBOXY-ADIPIC ACID (three-letter code: HCA) (formula: C₇H₁₀O₇) (labeled as "Ligand of Interest" by depositor).

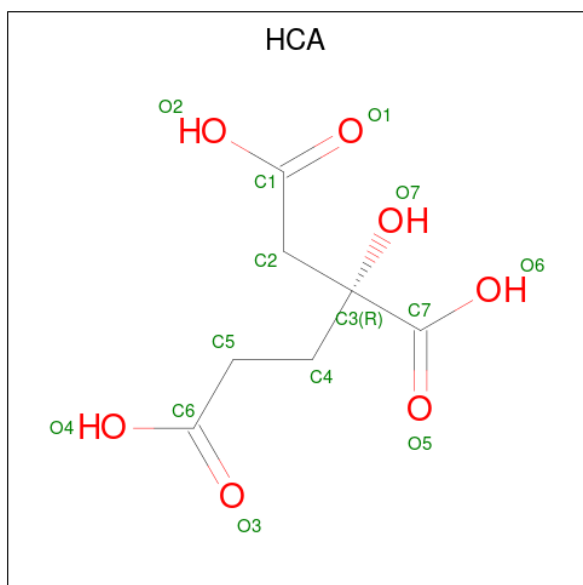

Mol	Chain	Residues	Atoms			ZeroOcc	AltConf
3	A	1	Total	C	O	0	0
			14	7	7		
3	C	1	Total	C	O	0	0
			14	7	7		

- Molecule 4 is iron-sulfur-molybdenum cluster with interstitial carbon (three-letter code: ICE) (formula: CFe_7MoS_8) (labeled as "Ligand of Interest" by depositor).

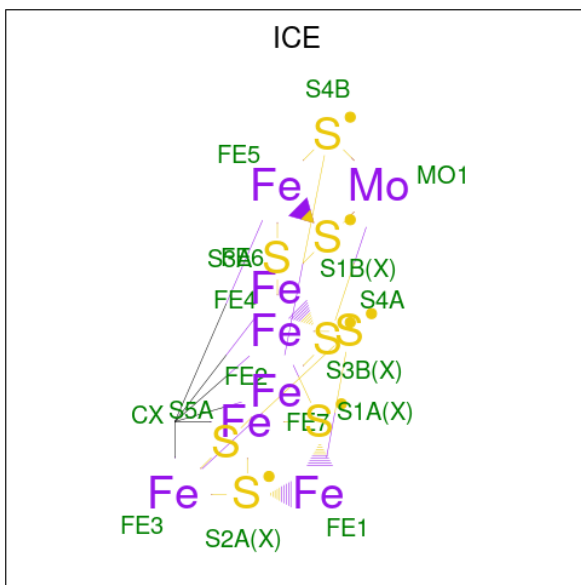

Mol	Chain	Residues	Atoms					ZeroOcc	AltConf
4	A	1	Total	C	Fe	Mo	S	0	0
			17	1	7	1	8		

- Molecule 5 is NITROGEN MOLECULE (three-letter code: HDZ) (formula: N_2) (labeled as "Ligand of Interest" by depositor).

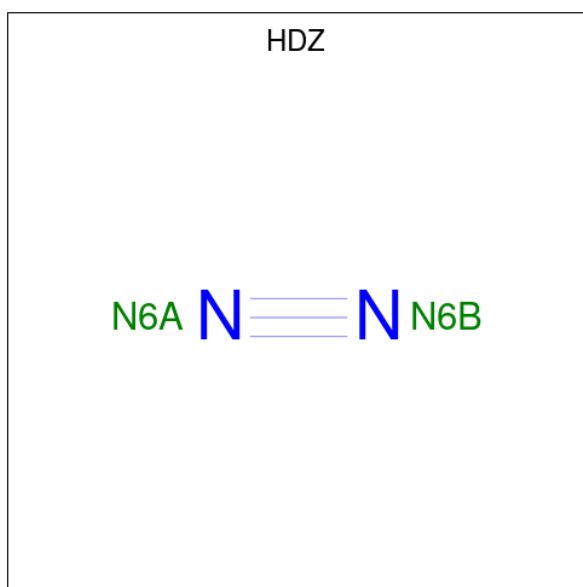

Mol	Chain	Residues	Atoms	ZeroOcc	AltConf
5	A	1	Total N 2 2	0	0
5	C	1	Total N 2 2	0	0
5	C	1	Total N 2 2	0	0

- Molecule 6 is HYDROSULFURIC ACID (three-letter code: H2S) (formula: H₂S).

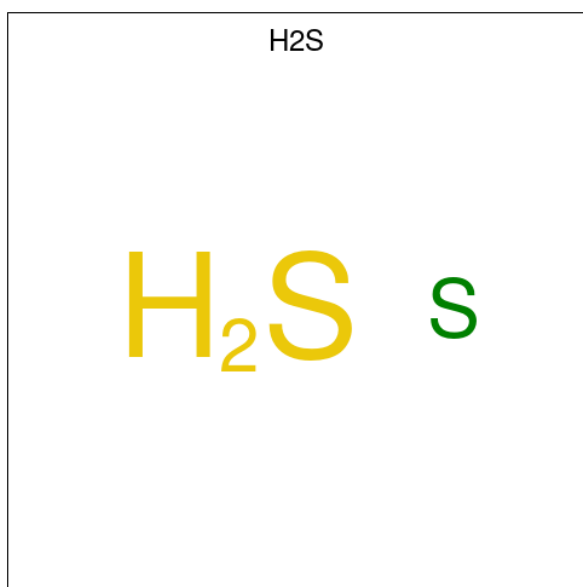

Mol	Chain	Residues	Atoms	ZeroOcc	AltConf
6	A	1	Total S 1 1	0	0

Continued on next page...

Continued from previous page...

Mol	Chain	Residues	Atoms	ZeroOcc	AltConf
6	B	1	Total S 1 1	0	0
6	B	1	Total S 1 1	0	0
6	C	1	Total S 1 1	0	0
6	C	1	Total S 1 1	0	0
6	D	1	Total S 1 1	0	0

- Molecule 7 is MOLYBDENUM ATOM (three-letter code: MO) (formula: Mo).

Mol	Chain	Residues	Atoms	ZeroOcc	AltConf
7	A	3	Total Mo 3 3	0	0
7	B	1	Total Mo 1 1	0	0
7	C	3	Total Mo 3 3	0	0
7	D	1	Total Mo 1 1	0	0

- Molecule 8 is FE(8)-S(7) CLUSTER, OXIDIZED (three-letter code: 1CL) (formula: Fe₈S₇) (labeled as "Ligand of Interest" by depositor).

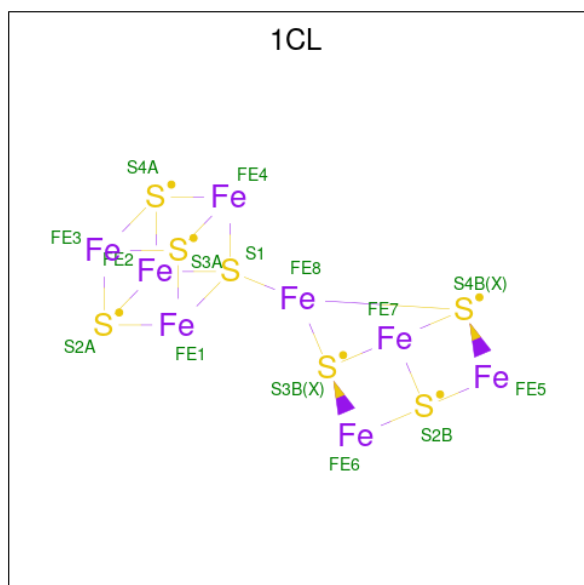

Mol	Chain	Residues	Atoms			ZeroOcc	AltConf
8	A	1	Total	Fe	S	0	0
			15	8	7		
8	C	1	Total	Fe	S	0	0
			15	8	7		

- Molecule 9 is FE (III) ION (three-letter code: FE) (formula: Fe).

Mol	Chain	Residues	Atoms		ZeroOcc	AltConf
9	B	2	Total	Fe	0	0
			2	2		

- Molecule 10 is GLYCEROL (three-letter code: GOL) (formula: C₃H₈O₃).

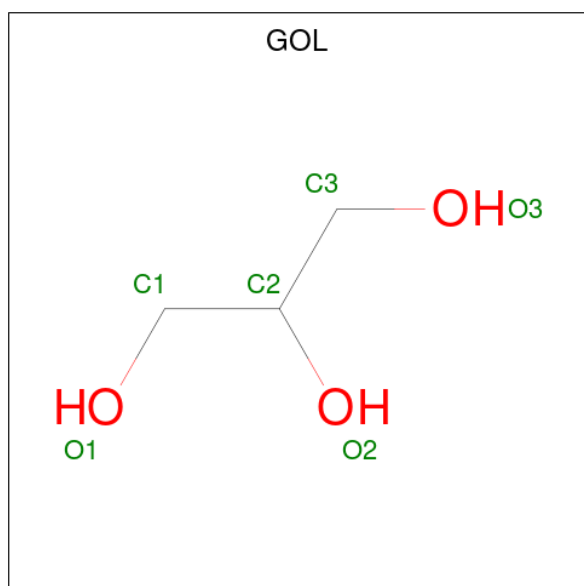

Mol	Chain	Residues	Atoms			ZeroOcc	AltConf
10	B	1	Total	C	O	0	0
			6	3	3		
10	C	1	Total	C	O	0	0
			6	3	3		
10	C	1	Total	C	O	0	0
			6	3	3		
10	D	1	Total	C	O	0	0
			6	3	3		
10	D	1	Total	C	O	0	0
			6	3	3		
10	D	1	Total	C	O	0	0
			6	3	3		

- Molecule 11 is TRIETHYLENE GLYCOL (three-letter code: PGE) (formula: $C_6H_{14}O_4$).

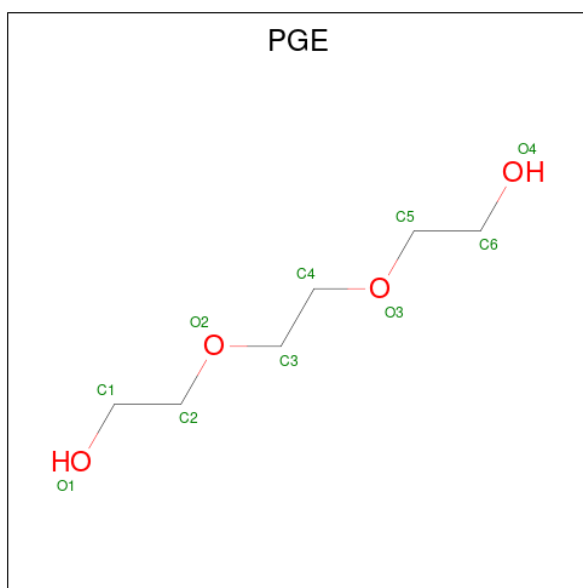

Mol	Chain	Residues	Atoms			ZeroOcc	AltConf
11	B	1	Total	C	O	0	0
			10	6	4		

- Molecule 12 is iron-sulfur-molybdenum cluster with interstitial carbon (three-letter code: ICZ) (formula: CFe_7MoS_7) (labeled as "Ligand of Interest" by depositor).

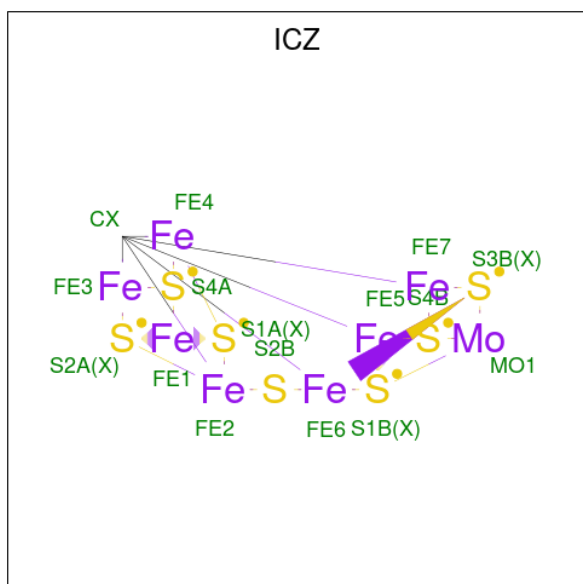

Mol	Chain	Residues	Atoms				ZeroOcc	AltConf	
12	C	1	Total	C	Fe	Mo	S	0	0
			16	1	7	1	7		

- Molecule 13 is water.

Mol	Chain	Residues	Atoms		ZeroOcc	AltConf
13	A	124	Total 124	O 124	0	0
13	B	207	Total 207	O 207	0	0
13	C	205	Total 205	O 205	0	0
13	D	241	Total 241	O 241	0	0

3 Residue-property plots [i](#)

These plots are drawn for all protein, RNA, DNA and oligosaccharide chains in the entry. The first graphic for a chain summarises the proportions of the various outlier classes displayed in the second graphic. The second graphic shows the sequence view annotated by issues in geometry and electron density. Residues are color-coded according to the number of geometric quality criteria for which they contain at least one outlier: green = 0, yellow = 1, orange = 2 and red = 3 or more. A red dot above a residue indicates a poor fit to the electron density ($RSRZ > 2$). Stretches of 2 or more consecutive residues without any outlier are shown as a green connector. Residues present in the sample, but not in the model, are shown in grey.

- Molecule 1: Nitrogenase molybdenum-iron protein alpha chain

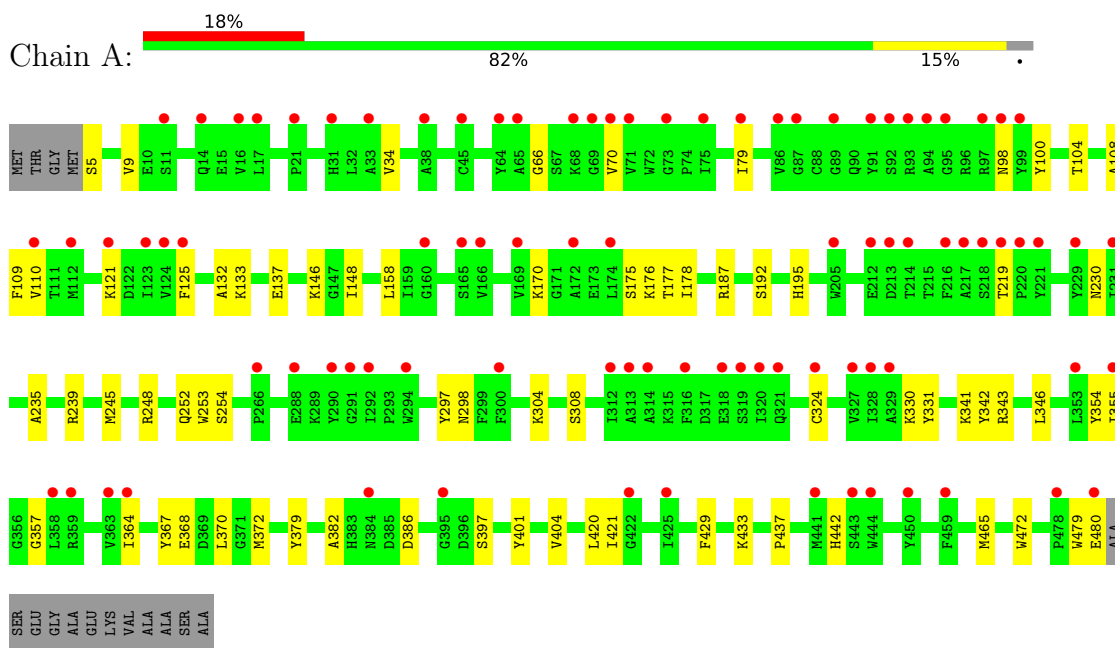

- Molecule 1: Nitrogenase molybdenum-iron protein alpha chain

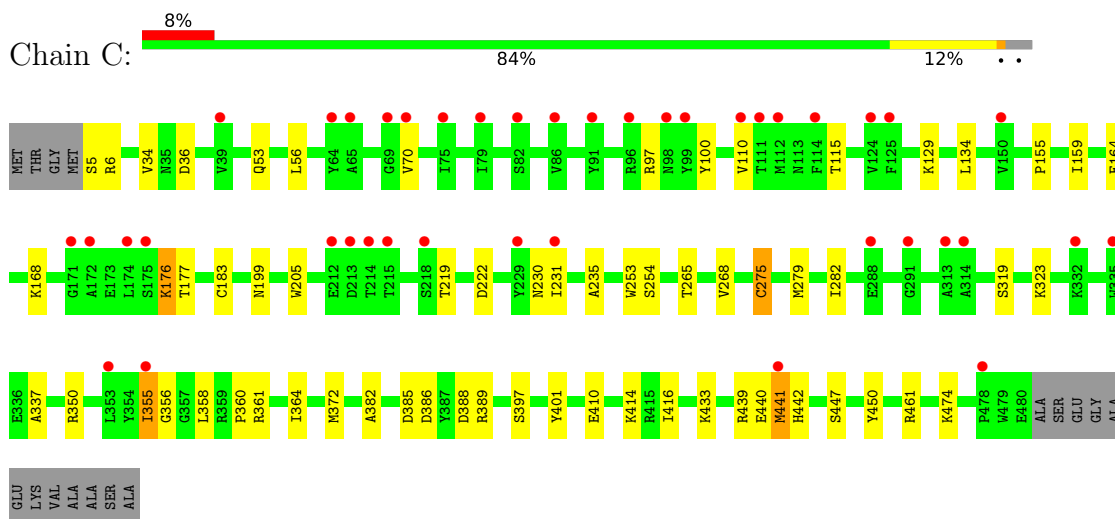

- Molecule 2: Nitrogenase molybdenum-iron protein beta chain

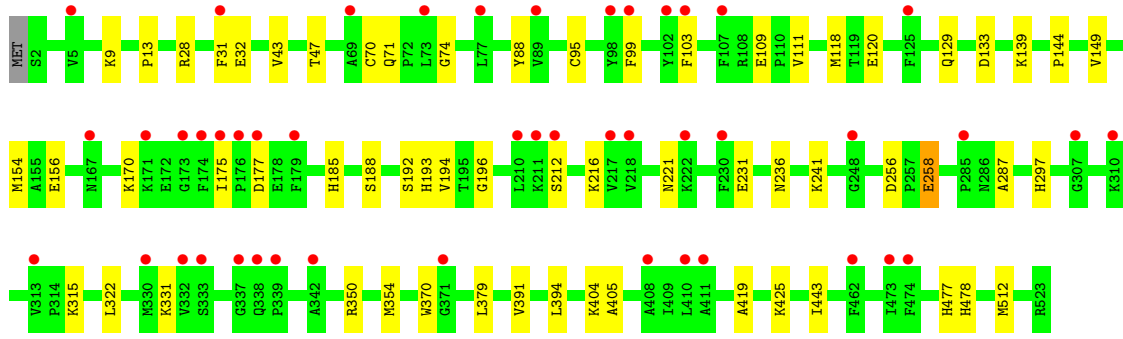
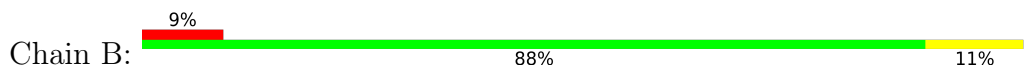

• Molecule 2: Nitrogenase molybdenum-iron protein beta chain

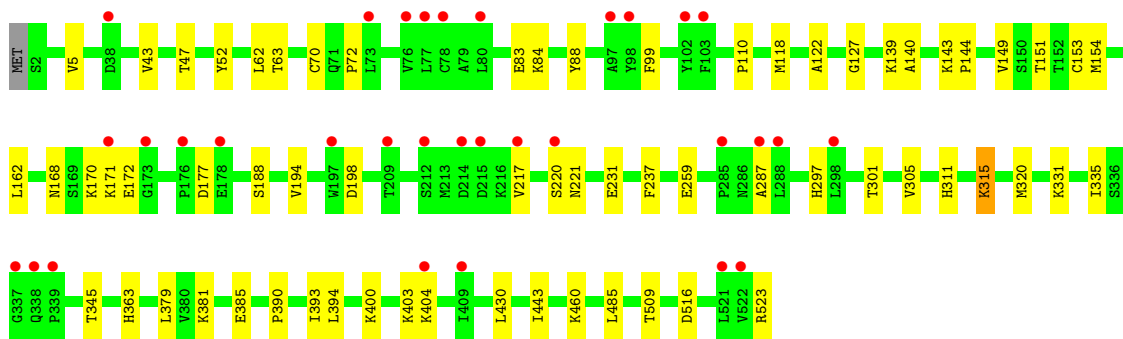
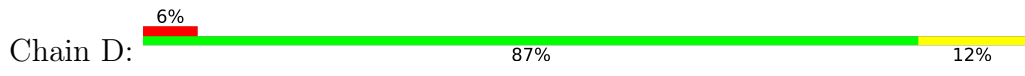

4 Data and refinement statistics

Property	Value	Source
Space group	P 21 21 2	Depositor
Cell constants a, b, c, α , β , γ	84.36Å 156.97Å 202.34Å 90.00° 90.00° 90.00°	Depositor
Resolution (Å)	39.19 – 1.83 39.19 – 1.83	Depositor EDS
% Data completeness (in resolution range)	93.8 (39.19-1.83) 93.8 (39.19-1.83)	Depositor EDS
R_{merge}	(Not available)	Depositor
R_{sym}	(Not available)	Depositor
$\langle I/\sigma(I) \rangle$ ¹	1.10 (at 1.83Å)	Xtrriage
Refinement program	PHENIX v1.16-3549	Depositor
R, R_{free}	0.218 , 0.259 0.218 , 0.259	Depositor DCC
R_{free} test set	1969 reflections (0.88%)	wwPDB-VP
Wilson B-factor (Å ²)	31.6	Xtrriage
Anisotropy	0.476	Xtrriage
Bulk solvent k_{sol} (e/Å ³), B_{sol} (Å ²)	0.35 , 52.0	EDS
L-test for twinning ²	$\langle L \rangle = 0.48$, $\langle L^2 \rangle = 0.31$	Xtrriage
Estimated twinning fraction	No twinning to report.	Xtrriage
F_o, F_c correlation	0.96	EDS
Total number of atoms	16514	wwPDB-VP
Average B, all atoms (Å ²)	49.0	wwPDB-VP

Xtrriage's analysis on translational NCS is as follows: *The analyses of the Patterson function reveals a significant off-origin peak that is 41.97 % of the origin peak, indicating pseudo-translational symmetry. The chance of finding a peak of this or larger height randomly in a structure without pseudo-translational symmetry is equal to 2.1842e-04. The detected translational NCS is most likely also responsible for the elevated intensity ratio.*

¹Intensities estimated from amplitudes.

²Theoretical values of $\langle |L| \rangle$, $\langle L^2 \rangle$ for acentric reflections are 0.5, 0.333 respectively for untwinned datasets, and 0.375, 0.2 for perfectly twinned datasets.

5 Model quality [i](#)

5.1 Standard geometry [i](#)

Bond lengths and bond angles in the following residue types are not validated in this section: GOL, HDZ, 1CL, HCA, MO, FE, H2S, ICE, PGE, ICZ

The Z score for a bond length (or angle) is the number of standard deviations the observed value is removed from the expected value. A bond length (or angle) with $|Z| > 5$ is considered an outlier worth inspection. RMSZ is the root-mean-square of all Z scores of the bond lengths (or angles).

Mol	Chain	Bond lengths		Bond angles	
		RMSZ	# Z >5	RMSZ	# Z >5
1	A	0.44	0/3745	0.59	0/5072
1	C	0.49	1/3820 (0.0%)	0.65	5/5162 (0.1%)
2	B	0.44	0/4187	0.57	0/5677
2	D	0.45	0/4218	0.59	0/5716
All	All	0.45	1/15970 (0.0%)	0.60	5/21627 (0.0%)

All (1) bond length outliers are listed below:

Mol	Chain	Res	Type	Atoms	Z	Observed(Å)	Ideal(Å)
1	C	183	CYS	CB-SG	5.42	1.91	1.82

All (5) bond angle outliers are listed below:

Mol	Chain	Res	Type	Atoms	Z	Observed(°)	Ideal(°)
1	C	441	MET	CG-SD-CE	7.72	112.55	100.20
1	C	441	MET	CA-CB-CG	-6.20	102.77	113.30
1	C	275	CYS	CA-CB-SG	-5.22	104.61	114.00
1	C	388	ASP	CB-CG-OD2	-5.22	113.60	118.30
1	C	388	ASP	CB-CG-OD1	5.07	122.86	118.30

There are no chirality outliers.

There are no planarity outliers.

5.2 Too-close contacts [i](#)

In the following table, the Non-H and H(model) columns list the number of non-hydrogen atoms and hydrogen atoms in the chain respectively. The H(added) column lists the number of hydrogen atoms added and optimized by MolProbity. The Clashes column lists the number of clashes within the asymmetric unit, whereas Symm-Clashes lists symmetry-related clashes.

Mol	Chain	Non-H	H(model)	H(added)	Clashes	Symm-Clashes
1	A	3657	0	3494	41	0
1	C	3728	0	3619	40	0
2	B	4081	0	3923	39	0
2	D	4112	0	3966	49	0
3	A	14	0	6	3	0
3	C	14	0	7	3	0
4	A	17	0	0	0	0
5	A	2	0	0	0	0
5	C	4	0	0	0	0
6	A	1	0	0	0	0
6	B	2	0	0	0	0
6	C	2	0	0	0	0
6	D	1	0	0	0	0
7	A	3	0	0	0	0
7	B	1	0	0	0	0
7	C	3	0	0	0	0
7	D	1	0	0	0	0
8	A	15	0	0	0	0
8	C	15	0	0	0	0
9	B	2	0	0	0	0
10	B	6	0	8	0	0
10	C	12	0	16	2	0
10	D	18	0	24	3	0
11	B	10	0	14	0	0
12	C	16	0	0	2	0
13	A	124	0	0	0	0
13	B	207	0	0	1	0
13	C	205	0	0	2	0
13	D	241	0	0	1	0
All	All	16514	0	15077	162	0

The all-atom clashscore is defined as the number of clashes found per 1000 atoms (including hydrogen atoms). The all-atom clashscore for this structure is 5.

All (162) close contacts within the same asymmetric unit are listed below, sorted by their clash magnitude.

Atom-1	Atom-2	Interatomic distance (Å)	Clash overlap (Å)
2:B:118:MET:HB2	2:B:154:MET:HE1	1.58	0.85
2:D:168:ASN:HA	2:D:171:LYS:HG2	1.62	0.80
2:B:170:LYS:HG2	2:B:175:ILE:HD11	1.72	0.70
2:D:217:VAL:HB	2:D:220:SER:OG	1.93	0.69
3:C:502:HCA:H21	10:D:602:GOL:H2	1.77	0.66

Continued on next page...

Continued from previous page...

Atom-1	Atom-2	Interatomic distance (Å)	Clash overlap (Å)
1:C:199:ASN:HD22	1:C:282:ILE:H	1.43	0.65
2:B:175:ILE:HD12	2:B:175:ILE:O	1.98	0.63
2:B:109:GLU:OE2	13:B:701:HOH:O	2.14	0.63
1:C:441:MET:HE1	1:C:450:TYR:HE2	1.64	0.63
1:A:132:ALA:HB1	1:A:170:LYS:HE2	1.80	0.62
2:D:320:MET:HG3	2:D:485:LEU:HD23	1.81	0.62
1:A:429:PHE:O	1:A:433:LYS:HG2	2.01	0.60
2:B:9:LYS:HB3	2:B:13:PRO:HD2	1.84	0.59
1:C:134:LEU:HD12	2:D:62:LEU:HA	1.84	0.59
1:A:367:TYR:HD1	1:A:372:MET:HE3	1.67	0.59
2:B:241:LYS:NZ	2:B:258:GLU:OE1	2.23	0.59
2:D:171:LYS:HE2	2:D:172:GLU:HG3	1.86	0.58
1:A:146:LYS:C	1:A:176:LYS:HE3	2.25	0.57
2:B:212:SER:HB2	2:B:216:LYS:NZ	2.20	0.56
1:C:53:GLN:HB2	1:C:56:LEU:HD12	1.88	0.56
1:C:168:LYS:HE2	1:C:205:TRP:HH2	1.70	0.56
1:A:121:LYS:HG2	1:A:125:PHE:HD2	1.70	0.56
2:D:400:LYS:O	2:D:404:LYS:HG2	2.08	0.54
2:B:170:LYS:HG2	2:B:175:ILE:CD1	2.38	0.54
3:C:502:HCA:O1	3:C:502:HCA:O7	2.22	0.54
1:A:5:SER:O	1:A:9:VAL:HG23	2.08	0.53
1:A:343:ARG:HG3	1:A:370:LEU:C	2.28	0.53
2:D:390:PRO:HB2	2:D:393:ILE:HD11	1.90	0.53
1:A:442:HIS:ND1	3:A:601:HCA:H52	2.24	0.52
2:B:170:LYS:HD3	2:B:177:ASP:HA	1.91	0.52
1:A:239:ARG:HD2	1:A:252:GLN:OE1	2.10	0.51
1:A:479:TRP:HE1	2:D:345:THR:HG22	1.75	0.51
2:D:221:ASN:OD1	2:D:287:ALA:HA	2.11	0.51
1:A:354:TYR:CZ	1:A:404:VAL:HG12	2.45	0.51
1:C:100:TYR:CE1	1:C:110:VAL:HB	2.44	0.51
1:C:6:ARG:HH22	1:C:36:ASP:HB2	1.75	0.51
1:A:104:THR:HA	1:A:108:ALA:O	2.10	0.51
2:D:43:VAL:O	2:D:47:THR:HG23	2.10	0.51
2:B:322:LEU:HD21	1:C:474:LYS:HB3	1.93	0.51
2:B:221:ASN:OD1	2:B:287:ALA:HA	2.11	0.50
2:D:217:VAL:O	2:D:220:SER:OG	2.23	0.50
2:D:118:MET:HE2	2:D:122:ALA:HB1	1.93	0.50
2:B:404:LYS:HE2	2:B:405:ALA:N	2.27	0.50
1:A:479:TRP:HE1	2:D:345:THR:CG2	2.25	0.49
1:A:465:MET:HG3	2:D:363:HIS:CG	2.48	0.49
1:A:382:ALA:HB1	1:A:386:ASP:HB2	1.94	0.49

Continued on next page...

Continued from previous page...

Atom-1	Atom-2	Interatomic distance (Å)	Clash overlap (Å)
2:D:170:LYS:HD3	2:D:177:ASP:HA	1.95	0.49
1:A:297:TYR:HB2	1:A:308:SER:HB3	1.95	0.49
2:B:370:TRP:HA	2:B:394:LEU:O	2.13	0.49
1:A:158:LEU:HD11	2:B:154:MET:HG3	1.95	0.48
1:C:275:CYS:HA	1:C:358:LEU:HD22	1.94	0.48
2:D:139:LYS:HA	2:D:144:PRO:HD2	1.95	0.48
1:A:100:TYR:CE1	1:A:110:VAL:HB	2.49	0.48
1:A:330:LYS:HE2	1:A:331:TYR:CZ	2.48	0.48
2:B:139:LYS:HA	2:B:144:PRO:HD2	1.96	0.48
1:C:164:GLU:O	1:C:168:LYS:HG3	2.14	0.47
1:A:187:ARG:HA	2:B:120:GLU:HG2	1.96	0.47
1:A:367:TYR:HD1	1:A:372:MET:CE	2.27	0.47
1:C:441:MET:HE3	13:C:700:HOH:O	2.14	0.47
2:B:391:VAL:HA	2:B:419:ALA:HA	1.96	0.47
1:C:53:GLN:NE2	13:C:617:HOH:O	2.47	0.47
1:C:319:SER:O	1:C:323:LYS:HG3	2.15	0.47
2:D:72:PRO:HB2	2:D:99:PHE:CZ	2.50	0.47
2:D:171:LYS:HG3	2:D:172:GLU:N	2.30	0.47
2:D:394:LEU:HD13	2:D:430:LEU:HB2	1.96	0.47
2:B:512:MET:HE2	2:B:512:MET:HB3	1.90	0.47
2:D:153:CYS:HB3	2:D:188:SER:OG	2.14	0.47
2:D:403:LYS:HB3	2:D:404:LYS:HE2	1.97	0.47
1:C:433:LYS:HE3	2:D:110:PRO:HD3	1.97	0.46
2:D:305:VAL:HG22	2:D:311:HIS:HB2	1.97	0.46
1:A:176:LYS:NZ	1:A:177:THR:H	2.13	0.46
2:D:171:LYS:HG3	2:D:172:GLU:HG3	1.96	0.46
1:A:420:LEU:HD12	1:A:421:ILE:H	1.80	0.46
3:A:601:HCA:O2	3:A:601:HCA:O7	2.32	0.46
1:C:115:THR:HG23	2:D:63:THR:HB	1.98	0.46
1:C:219:THR:OG1	1:C:222:ASP:OD1	2.29	0.46
2:D:118:MET:HB2	2:D:154:MET:HE1	1.97	0.46
2:B:95:CYS:HB3	2:B:99:PHE:CZ	2.50	0.46
1:C:199:ASN:HD21	1:C:279:MET:HA	1.80	0.46
2:B:43:VAL:O	2:B:47:THR:HG23	2.17	0.45
1:C:385:ASP:HB2	1:C:389:ARG:NH1	2.30	0.45
1:C:155:PRO:O	1:C:159:ILE:HG12	2.16	0.45
2:D:70:CYS:HB2	2:D:188:SER:HB2	1.98	0.45
2:D:151:THR:CG2	2:D:162:LEU:HD11	2.45	0.45
2:D:47:THR:HA	2:D:52:TYR:CG	2.51	0.45
2:D:118:MET:HE3	2:D:127:GLY:HA3	1.99	0.45
1:A:230:ASN:HA	1:A:235:ALA:H	1.81	0.45

Continued on next page...

Continued from previous page...

Atom-1	Atom-2	Interatomic distance (Å)	Clash overlap (Å)
2:B:394:LEU:HD21	2:B:425:LYS:O	2.16	0.45
1:C:442:HIS:HB3	3:C:502:HCA:O5	2.17	0.45
1:C:356:GLY:HA3	12:C:503:ICZ:S1B	2.57	0.45
2:D:83:GLU:HG2	2:D:84:LYS:HG3	1.98	0.45
2:D:381:LYS:O	2:D:385:GLU:HG3	2.17	0.45
1:C:129:LYS:HB2	1:C:129:LYS:HE2	1.77	0.45
2:D:194:VAL:HB	2:D:297:HIS:CG	2.52	0.45
2:D:301:THR:O	2:D:305:VAL:HG12	2.17	0.45
2:B:175:ILE:HD12	2:B:175:ILE:C	2.38	0.44
2:D:259:GLU:HG3	13:D:840:HOH:O	2.17	0.44
1:C:410:GLU:O	1:C:414:LYS:HG3	2.16	0.44
1:A:148:ILE:O	1:A:178:ILE:HA	2.17	0.44
2:B:88:TYR:O	2:B:149:VAL:HA	2.17	0.44
1:C:265:THR:O	1:C:268:VAL:HG22	2.18	0.44
2:B:212:SER:HB2	2:B:216:LYS:HZ1	1.82	0.44
2:D:379:LEU:HD21	2:D:443:ILE:HG21	2.00	0.44
2:D:404:LYS:HA	2:D:404:LYS:HD3	1.89	0.44
2:B:28:ARG:HA	2:B:32:GLU:HB2	2.00	0.44
1:C:70:VAL:HG21	12:C:503:ICZ:S2B	2.58	0.44
1:C:461:ARG:NH2	10:C:501:GOL:H31	2.33	0.44
1:A:219:THR:HG23	1:A:248:ARG:NH2	2.33	0.43
2:D:88:TYR:O	2:D:149:VAL:HA	2.18	0.43
2:D:315:LYS:HD2	2:D:315:LYS:HA	1.75	0.43
1:C:97:ARG:O	1:C:231:ILE:HA	2.18	0.43
2:B:156:GLU:OE2	2:B:185:HIS:ND1	2.46	0.43
2:D:118:MET:CB	2:D:154:MET:HE1	2.48	0.43
2:B:74:GLY:HA3	2:B:193:HIS:O	2.19	0.43
2:D:509:THR:O	2:D:516:ASP:HA	2.19	0.43
1:A:298:ASN:ND2	1:A:304:LYS:HE3	2.34	0.43
1:C:382:ALA:HB1	1:C:386:ASP:HB2	2.00	0.43
2:B:256:ASP:OD1	2:B:258:GLU:HG2	2.18	0.43
1:A:253:TRP:HA	1:A:254:SER:HA	1.65	0.42
2:D:231:GLU:OE2	10:D:605:GOL:O1	2.31	0.42
1:A:437:PRO:HA	1:A:472:TRP:CZ2	2.54	0.42
2:D:231:GLU:HA	10:D:605:GOL:H12	2.01	0.42
2:D:331:LYS:O	2:D:335:ILE:HG13	2.20	0.42
1:C:253:TRP:HA	1:C:254:SER:HA	1.81	0.42
1:C:355:ILE:HB	1:C:360:PRO:HD3	2.01	0.42
1:C:350:ARG:NH2	1:C:416:ILE:O	2.35	0.42
2:D:140:ALA:O	2:D:143:LYS:NZ	2.44	0.42
1:A:133:LYS:O	1:A:137:GLU:HG3	2.19	0.42

Continued on next page...

Continued from previous page...

Atom-1	Atom-2	Interatomic distance (Å)	Clash overlap (Å)
1:A:357:GLY:HA2	1:A:379:TYR:HD2	1.83	0.42
2:B:212:SER:O	2:B:216:LYS:HE3	2.20	0.42
1:C:230:ASN:HA	1:C:235:ALA:H	1.83	0.42
1:C:34:VAL:HG12	1:C:397:SER:HA	2.01	0.42
2:D:198:ASP:HB2	2:D:297:HIS:O	2.20	0.42
1:A:79:ILE:HG13	1:A:109:PHE:CD2	2.55	0.41
1:A:364:ILE:O	1:A:368:GLU:HG3	2.19	0.41
2:B:231:GLU:CD	2:B:236:ASN:HD22	2.23	0.41
2:B:477:HIS:HB3	2:B:478:HIS:CD2	2.55	0.41
1:C:439:ARG:O	1:C:441:MET:HG2	2.20	0.41
1:A:442:HIS:CG	3:A:601:HCA:H52	2.55	0.41
2:B:103:PHE:HB3	2:B:111:VAL:HG21	2.01	0.41
1:C:440:GLU:C	1:C:441:MET:HG2	2.39	0.41
1:A:346:LEU:HB3	1:A:372:MET:SD	2.59	0.41
2:B:194:VAL:HB	2:B:297:HIS:CG	2.54	0.41
2:B:350:ARG:O	2:B:354:MET:HG3	2.20	0.41
2:B:379:LEU:HD21	2:B:443:ILE:HG21	2.01	0.41
1:C:337:ALA:HB1	2:D:5:VAL:HG11	2.01	0.41
1:C:447:SER:HB2	10:C:501:GOL:H12	2.00	0.41
2:B:192:SER:OG	2:B:194:VAL:HG22	2.20	0.41
1:C:372:MET:HB3	1:C:372:MET:HE2	1.93	0.41
2:B:71:GLN:O	2:B:196:GLY:HA3	2.20	0.41
1:C:361:ARG:HA	1:C:364:ILE:HD12	2.03	0.41
1:A:341:LYS:HE2	1:A:342:TYR:OH	2.21	0.41
2:B:129:GLN:NE2	2:B:133:ASP:OD2	2.53	0.41
1:C:176:LYS:HG3	1:C:177:THR:N	2.36	0.41
2:D:231:GLU:HB3	2:D:237:PHE:CZ	2.56	0.41
1:A:192:SER:O	1:A:195:HIS:HB2	2.21	0.40
1:A:34:VAL:HG12	1:A:397:SER:HA	2.04	0.40
1:A:66:GLY:O	1:A:70:VAL:HB	2.22	0.40
1:A:379:TYR:CD2	1:A:382:ALA:HB2	2.56	0.40
2:D:460:LYS:HA	2:D:460:LYS:HD3	1.87	0.40
2:B:70:CYS:HB2	2:B:188:SER:CB	2.51	0.40
1:A:245:MET:HG3	1:A:324:CYS:HA	2.04	0.40

There are no symmetry-related clashes.

5.3 Torsion angles [i](#)

5.3.1 Protein backbone [i](#)

In the following table, the Percentiles column shows the percent Ramachandran outliers of the chain as a percentile score with respect to all X-ray entries followed by that with respect to entries of similar resolution.

The Analysed column shows the number of residues for which the backbone conformation was analysed, and the total number of residues.

Mol	Chain	Analysed	Favoured	Allowed	Outliers	Percentiles	
1	A	474/492 (96%)	451 (95%)	22 (5%)	1 (0%)	47	33
1	C	475/492 (96%)	452 (95%)	22 (5%)	1 (0%)	47	33
2	B	520/523 (99%)	504 (97%)	16 (3%)	0	100	100
2	D	520/523 (99%)	509 (98%)	11 (2%)	0	100	100
All	All	1989/2030 (98%)	1916 (96%)	71 (4%)	2 (0%)	51	37

All (2) Ramachandran outliers are listed below:

Mol	Chain	Res	Type
1	C	355	ILE
1	A	355	ILE

5.3.2 Protein sidechains [i](#)

In the following table, the Percentiles column shows the percent sidechain outliers of the chain as a percentile score with respect to all X-ray entries followed by that with respect to entries of similar resolution.

The Analysed column shows the number of residues for which the sidechain conformation was analysed, and the total number of residues.

Mol	Chain	Analysed	Rotameric	Outliers	Percentiles	
1	A	370/415 (89%)	366 (99%)	4 (1%)	73	64
1	C	392/415 (94%)	389 (99%)	3 (1%)	81	75
2	B	427/455 (94%)	423 (99%)	4 (1%)	78	71
2	D	437/455 (96%)	435 (100%)	2 (0%)	88	85
All	All	1626/1740 (93%)	1613 (99%)	13 (1%)	81	75

All (13) residues with a non-rotameric sidechain are listed below:

Mol	Chain	Res	Type
1	A	98	ASN
1	A	175	SER
1	A	401	TYR
1	A	480	GLU
2	B	31	PHE
2	B	258	GLU
2	B	315	LYS
2	B	331	LYS
1	C	5	SER
1	C	176	LYS
1	C	401	TYR
2	D	315	LYS
2	D	523	ARG

Sometimes sidechains can be flipped to improve hydrogen bonding and reduce clashes. All (2) such sidechains are listed below:

Mol	Chain	Res	Type
1	C	98	ASN
1	C	199	ASN

5.3.3 RNA [i](#)

There are no RNA molecules in this entry.

5.4 Non-standard residues in protein, DNA, RNA chains [i](#)

There are no non-standard protein/DNA/RNA residues in this entry.

5.5 Carbohydrates [i](#)

There are no monosaccharides in this entry.

5.6 Ligand geometry [i](#)

Of 32 ligands modelled in this entry, 6 are modelled with single atom and 10 are monoatomic - leaving 16 for Mogul analysis.

In the following table, the Counts columns list the number of bonds (or angles) for which Mogul statistics could be retrieved, the number of bonds (or angles) that are observed in the model and the number of bonds (or angles) that are defined in the Chemical Component Dictionary. The

Link column lists molecule types, if any, to which the group is linked. The Z score for a bond length (or angle) is the number of standard deviations the observed value is removed from the expected value. A bond length (or angle) with $|Z| > 2$ is considered an outlier worth inspection. RMSZ is the root-mean-square of all Z scores of the bond lengths (or angles).

Mol	Type	Chain	Res	Link	Bond lengths			Bond angles		
					Counts	RMSZ	# Z > 2	Counts	RMSZ	# Z > 2
5	HDZ	C	504	12	1,1,1	0.32	0	-		
3	HCA	A	601	-	13,13,13	1.05	1 (7%)	14,18,18	2.80	4 (28%)
5	HDZ	C	511	12	1,1,1	0.29	0	-		
10	GOL	D	605	-	5,5,5	0.75	0	5,5,5	1.45	1 (20%)
10	GOL	C	510	-	5,5,5	1.04	0	5,5,5	0.96	0
3	HCA	C	502	-	13,13,13	1.06	0	14,18,18	2.33	4 (28%)
10	GOL	C	501	-	5,5,5	0.98	0	5,5,5	0.81	0
8	1CL	C	512	1,2	0,22,22	-	-	-		
4	ICE	A	602	1,5	12,28,28	2.23	5 (41%)	-		
10	GOL	B	605	-	5,5,5	0.77	0	5,5,5	1.11	1 (20%)
10	GOL	D	601	-	5,5,5	0.79	0	5,5,5	1.00	0
5	HDZ	A	603	4	1,1,1	0.37	0	-		
10	GOL	D	602	-	5,5,5	0.84	0	5,5,5	1.42	1 (20%)
11	PGE	B	606	-	9,9,9	0.40	0	8,8,8	0.40	0
12	ICZ	C	503	1,5	6,26,26	3.73	6 (100%)	-		
8	1CL	A	608	1,2	0,22,22	-	-	-		

In the following table, the Chirals column lists the number of chiral outliers, the number of chiral centers analysed, the number of these observed in the model and the number defined in the Chemical Component Dictionary. Similar counts are reported in the Torsion and Rings columns. '-' means no outliers of that kind were identified.

Mol	Type	Chain	Res	Link	Chirals	Torsions	Rings
3	HCA	A	601	-	-	9/17/17/17	-
10	GOL	D	605	-	-	4/4/4/4	-
10	GOL	C	510	-	-	2/4/4/4	-
3	HCA	C	502	-	-	4/17/17/17	-
10	GOL	C	501	-	-	2/4/4/4	-
10	GOL	D	601	-	-	0/4/4/4	-
10	GOL	D	602	-	-	2/4/4/4	-
10	GOL	B	605	-	-	4/4/4/4	-
8	1CL	C	512	1,2	-	-	0/10/8/8
11	PGE	B	606	-	-	4/7/7/7	-
8	1CL	A	608	1,2	-	-	0/10/8/8

All (12) bond length outliers are listed below:

Mol	Chain	Res	Type	Atoms	Z	Observed(Å)	Ideal(Å)
12	C	503	ICZ	S1B-FE6	-6.07	2.17	2.32
4	A	602	ICE	S3B-FE7	-4.43	2.21	2.32
12	C	503	ICZ	S2B-FE2	-3.66	2.16	2.24
4	A	602	ICE	S4B-FE7	-3.43	2.23	2.32
12	C	503	ICZ	S2A-FE2	-3.42	2.24	2.32
12	C	503	ICZ	S2B-FE6	-2.82	2.18	2.24
12	C	503	ICZ	S3B-FE6	-2.73	2.25	2.32
4	A	602	ICE	S4B-FE5	-2.63	2.25	2.32
4	A	602	ICE	S1B-FE5	-2.53	2.26	2.32
12	C	503	ICZ	S1A-FE2	-2.44	2.26	2.32
3	A	601	HCA	O6-C7	-2.11	1.22	1.30
4	A	602	ICE	S5A-FE3	-2.09	2.20	2.24

All (11) bond angle outliers are listed below:

Mol	Chain	Res	Type	Atoms	Z	Observed(°)	Ideal(°)
3	A	601	HCA	O6-C7-C3	7.57	126.20	113.05
3	C	502	HCA	O7-C3-C7	6.43	117.89	108.86
3	A	601	HCA	O7-C3-C7	4.34	114.96	108.86
3	A	601	HCA	O6-C7-O5	-3.24	113.53	123.82
3	C	502	HCA	O6-C7-C3	2.89	118.07	113.05
10	D	605	GOL	C3-C2-C1	-2.57	101.71	111.70
10	D	602	GOL	C3-C2-C1	-2.49	102.01	111.70
3	A	601	HCA	C2-C3-C7	-2.42	104.91	110.11
3	C	502	HCA	C3-C2-C1	-2.29	108.26	113.81
10	B	605	GOL	C3-C2-C1	-2.25	102.95	111.70
3	C	502	HCA	O6-C7-O5	-2.09	117.18	123.82

There are no chirality outliers.

All (31) torsion outliers are listed below:

Mol	Chain	Res	Type	Atoms
10	B	605	GOL	O1-C1-C2-C3
10	B	605	GOL	C1-C2-C3-O3
10	C	501	GOL	C1-C2-C3-O3
10	D	605	GOL	O1-C1-C2-C3
10	D	605	GOL	C1-C2-C3-O3
11	B	606	PGE	O1-C1-C2-O2
11	B	606	PGE	O2-C3-C4-O3
10	B	605	GOL	O1-C1-C2-O2
10	B	605	GOL	O2-C2-C3-O3

Continued on next page...

Continued from previous page...

Mol	Chain	Res	Type	Atoms
10	D	605	GOL	O1-C1-C2-O2
10	D	602	GOL	C1-C2-C3-O3
10	C	501	GOL	O2-C2-C3-O3
10	D	602	GOL	O2-C2-C3-O3
10	D	605	GOL	O2-C2-C3-O3
3	A	601	HCA	C2-C3-C7-O5
3	A	601	HCA	C2-C3-C7-O6
3	A	601	HCA	C4-C3-C7-O5
3	A	601	HCA	C4-C3-C7-O6
10	C	510	GOL	O1-C1-C2-O2
3	C	502	HCA	C1-C2-C3-O7
11	B	606	PGE	C1-C2-O2-C3
11	B	606	PGE	C6-C5-O3-C4
3	A	601	HCA	C1-C2-C3-C4
3	C	502	HCA	C1-C2-C3-C4
3	C	502	HCA	C1-C2-C3-C7
3	A	601	HCA	C4-C5-C6-O3
3	A	601	HCA	C4-C5-C6-O4
3	A	601	HCA	O1-C1-C2-C3
3	A	601	HCA	O2-C1-C2-C3
10	C	510	GOL	O1-C1-C2-C3
3	C	502	HCA	C3-C4-C5-C6

There are no ring outliers.

6 monomers are involved in 12 short contacts:

Mol	Chain	Res	Type	Clashes	Symm-Clashes
3	A	601	HCA	3	0
10	D	605	GOL	2	0
3	C	502	HCA	3	0
10	C	501	GOL	2	0
10	D	602	GOL	1	0
12	C	503	ICZ	2	0

The following is a two-dimensional graphical depiction of Mogul quality analysis of bond lengths, bond angles, torsion angles, and ring geometry for all instances of the Ligand of Interest. In addition, ligands with molecular weight > 250 and outliers as shown on the validation Tables will also be included. For torsion angles, if less than 5% of the Mogul distribution of torsion angles is within 10 degrees of the torsion angle in question, then that torsion angle is considered an outlier. Any bond that is central to one or more torsion angles identified as an outlier by Mogul will be highlighted in the graph. For rings, the root-mean-square deviation (RMSD) between the ring in question and similar rings identified by Mogul is calculated over all ring torsion angles. If the

average RMSD is greater than 60 degrees and the minimal RMSD between the ring in question and any Mogul-identified rings is also greater than 60 degrees, then that ring is considered an outlier. The outliers are highlighted in purple. The color gray indicates Mogul did not find sufficient equivalents in the CSD to analyse the geometry.

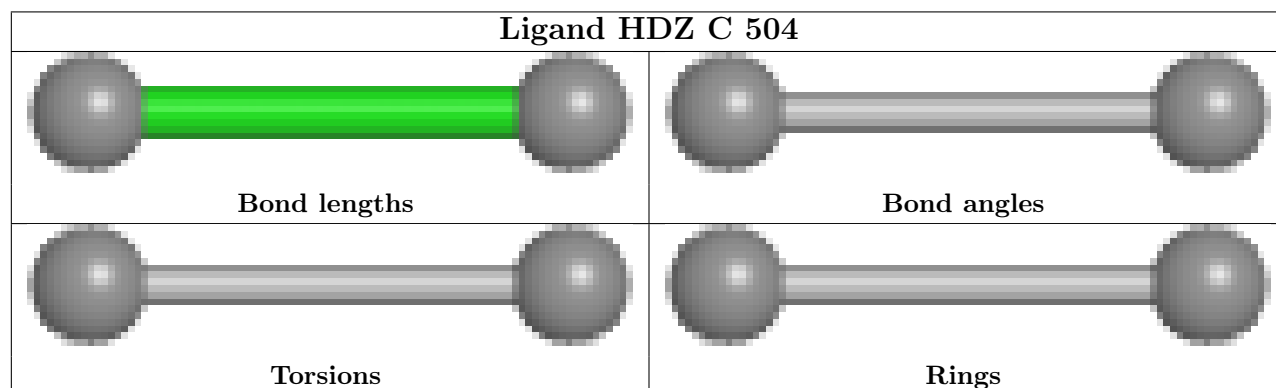

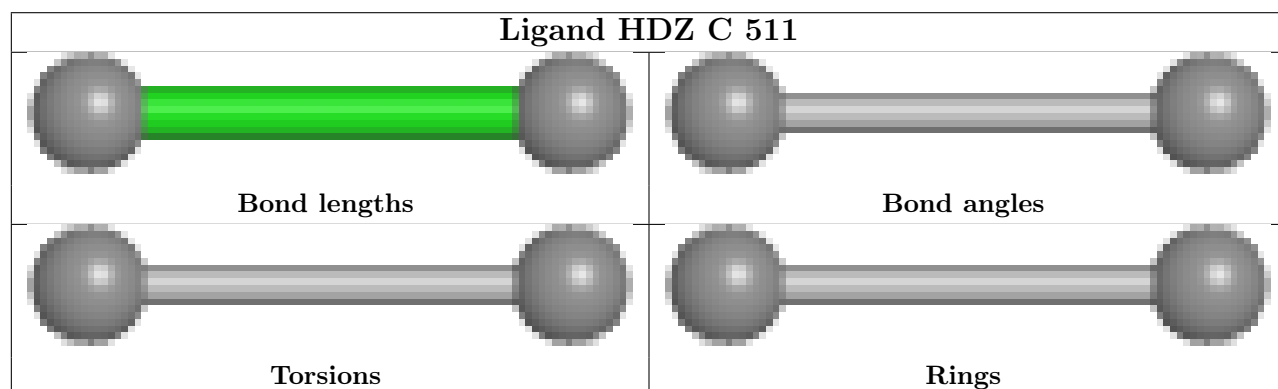
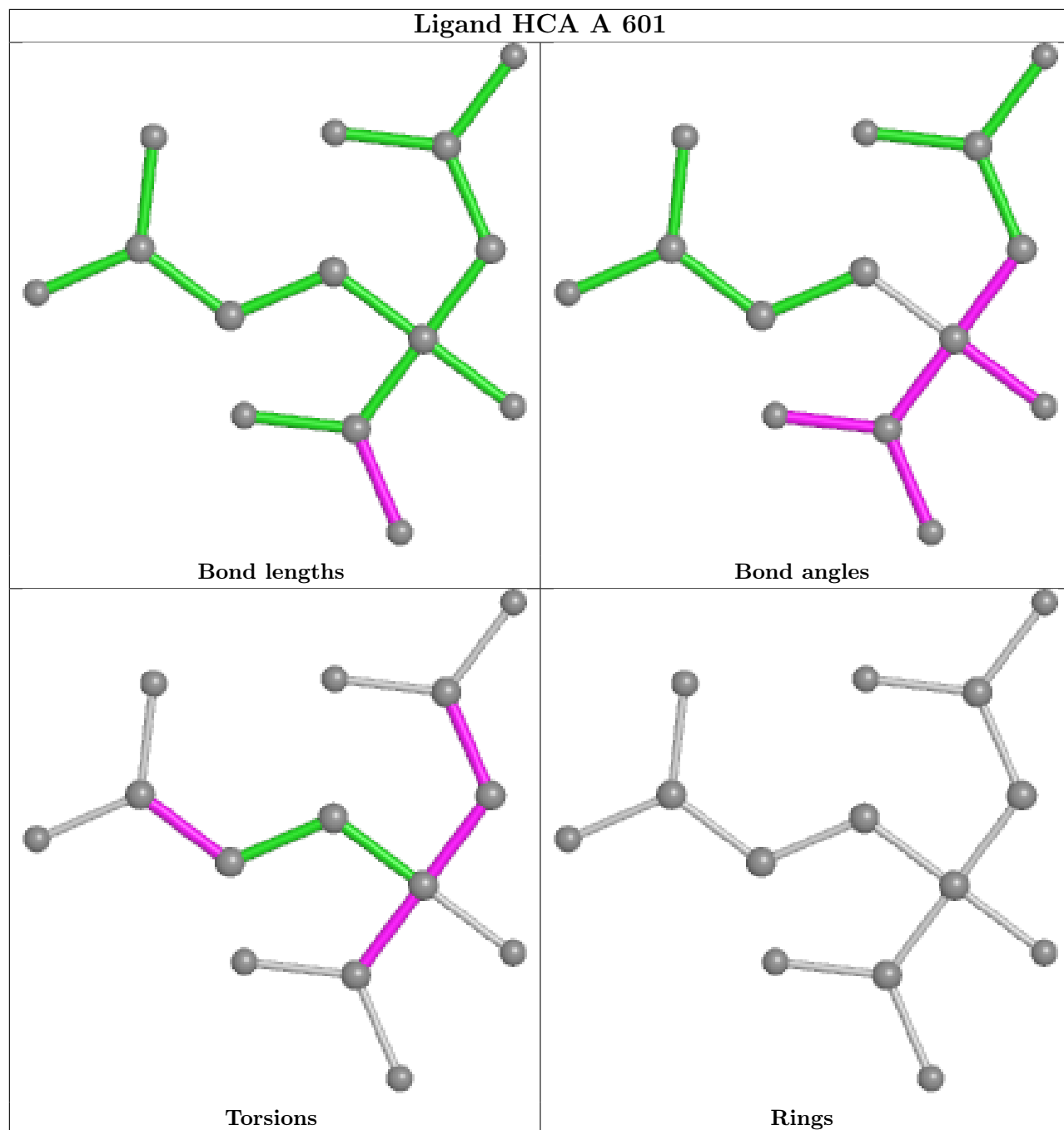

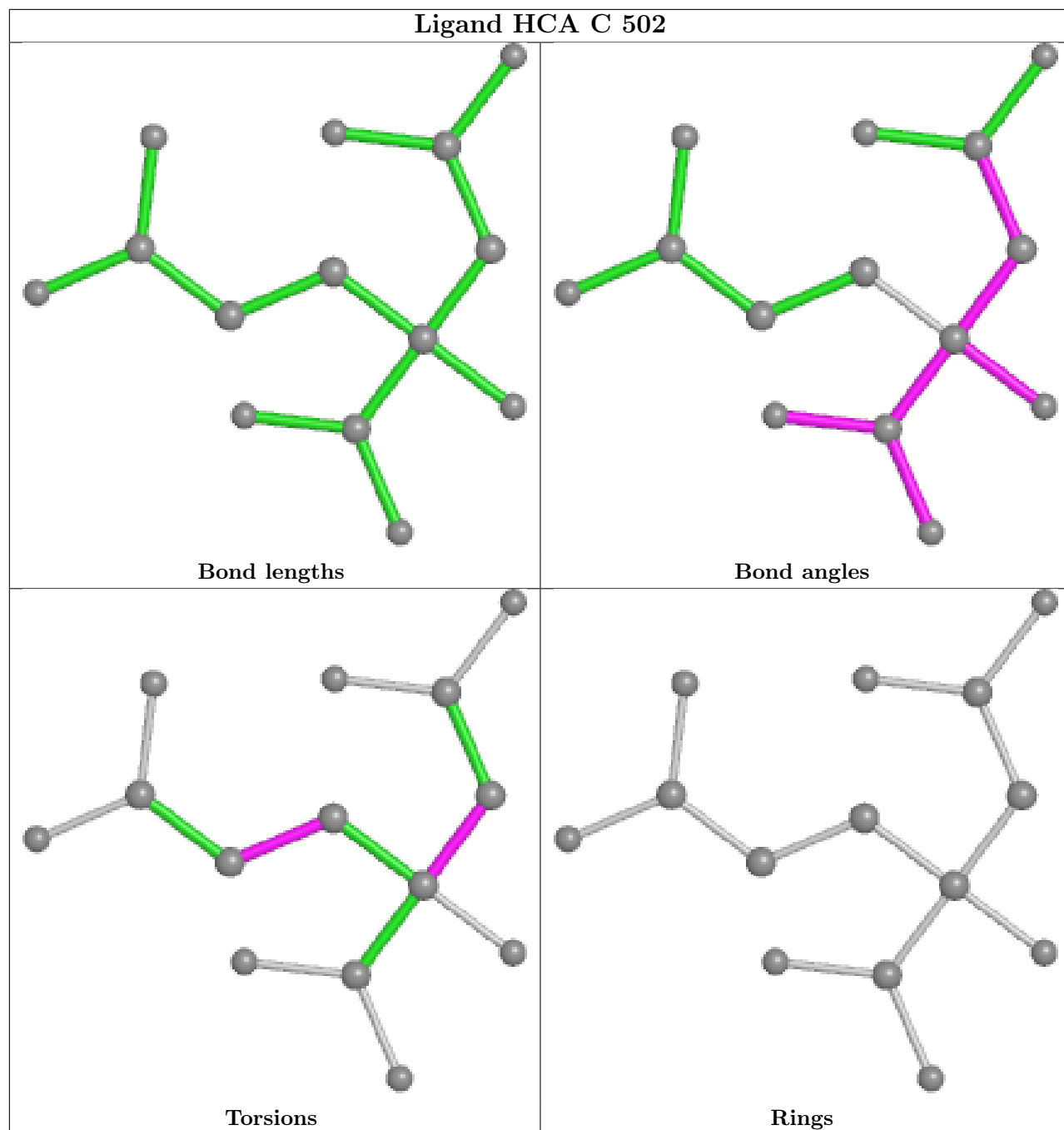

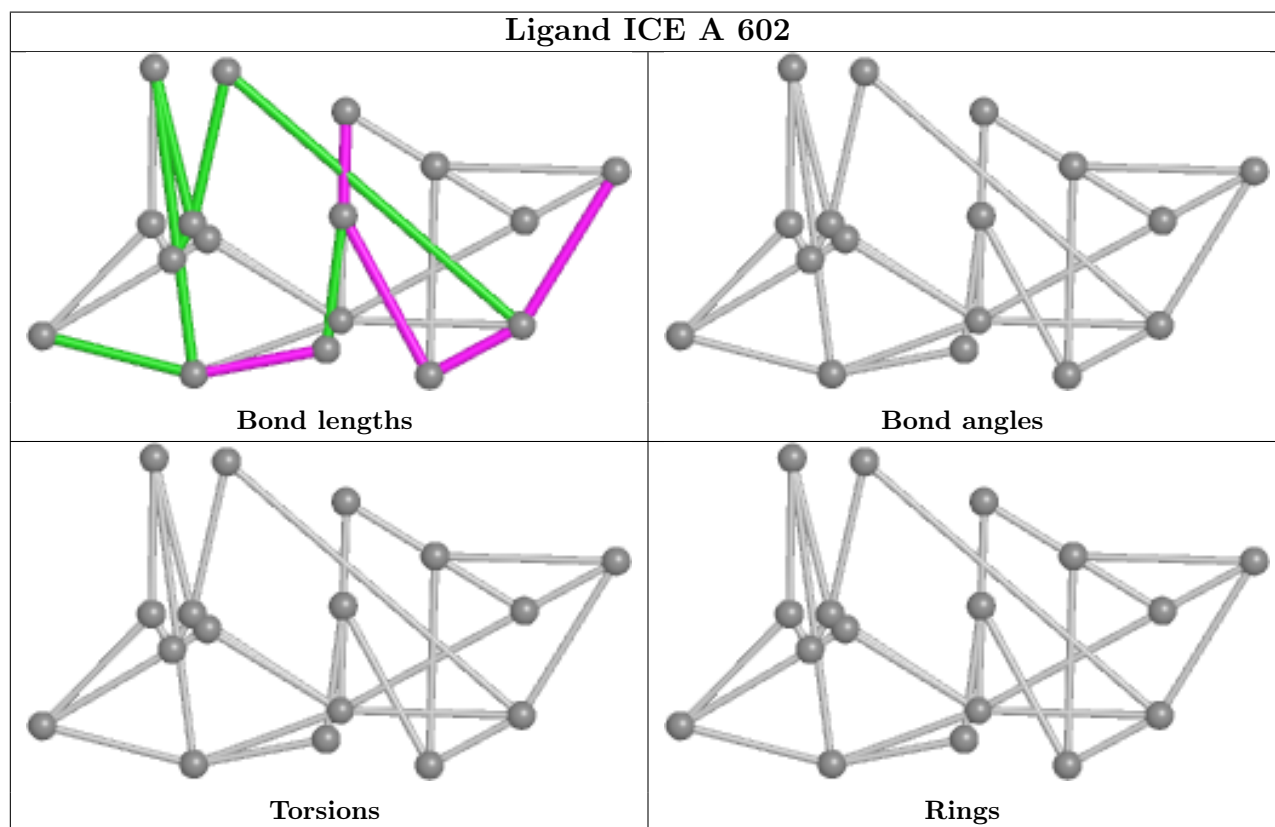
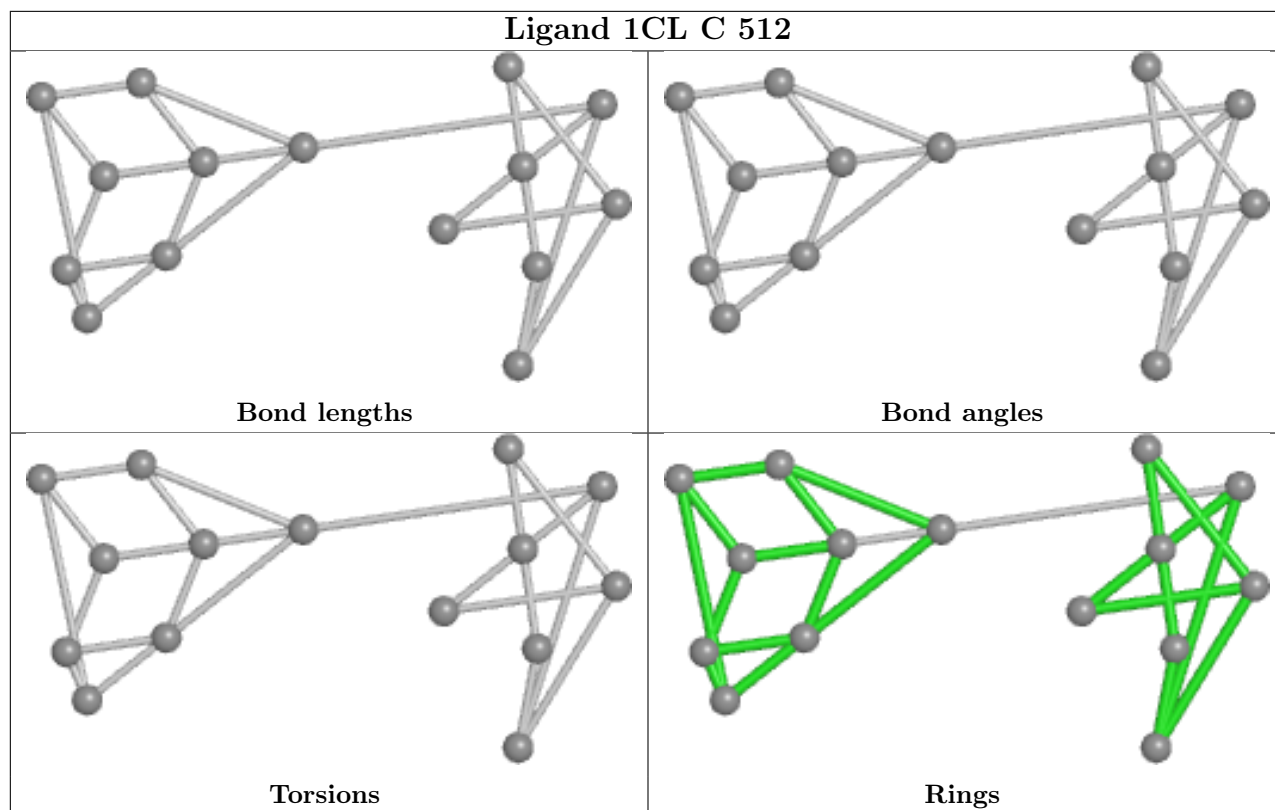

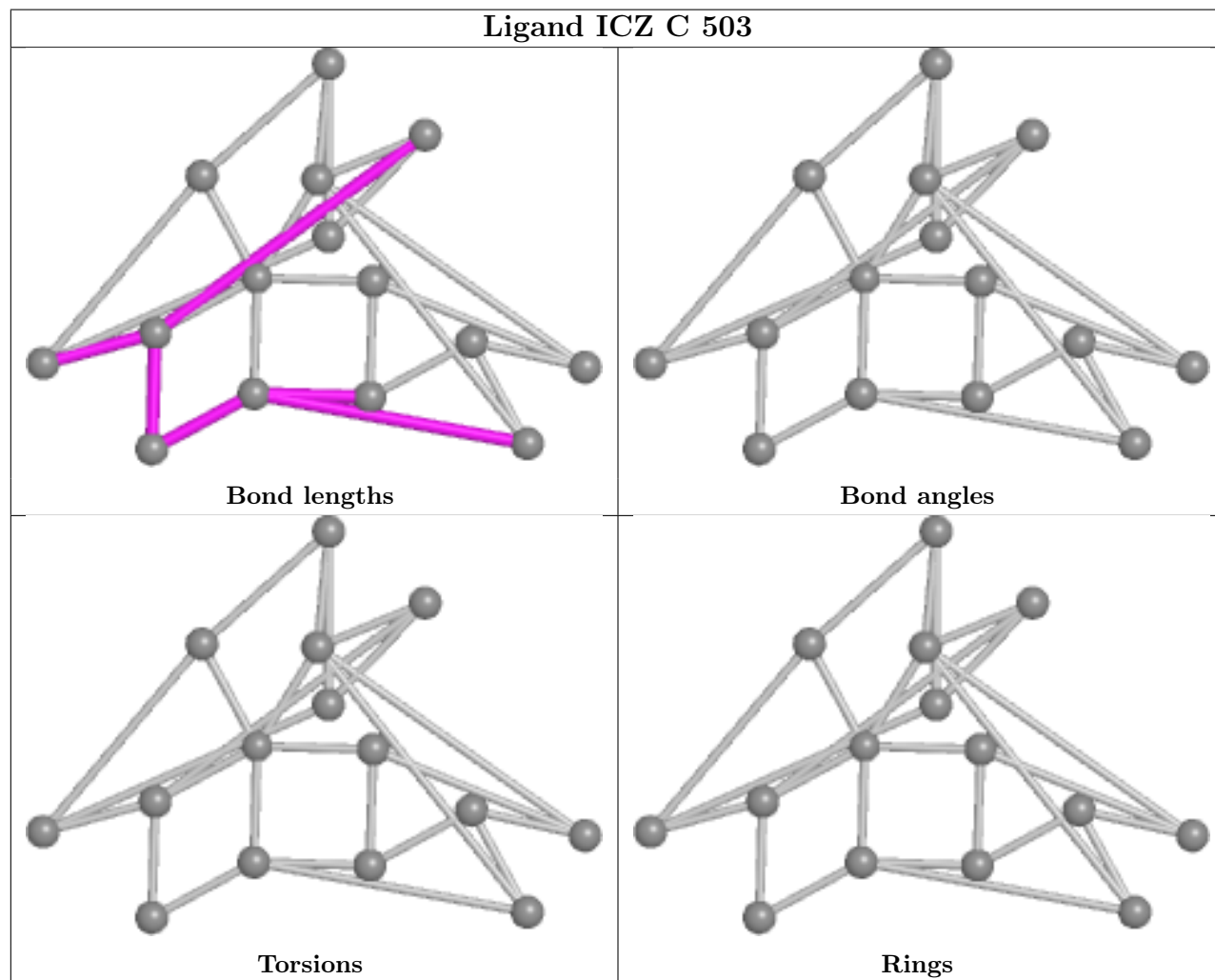
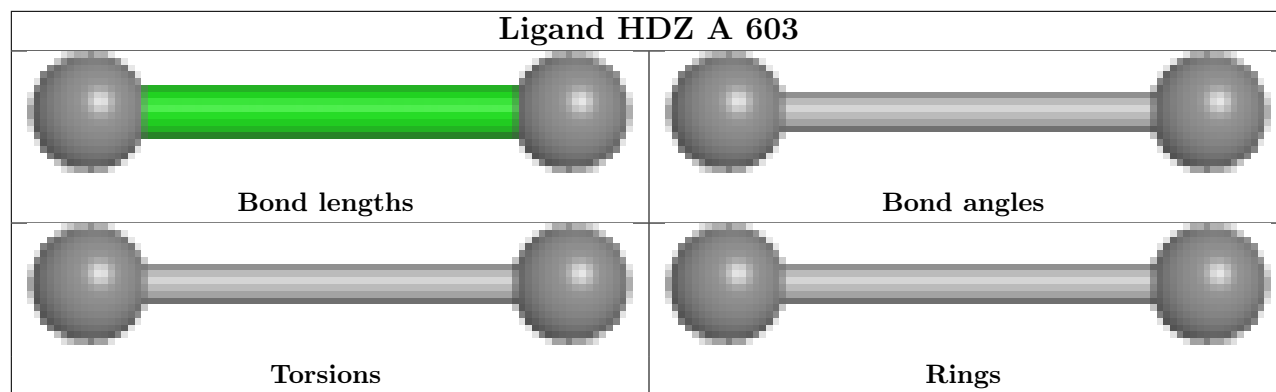

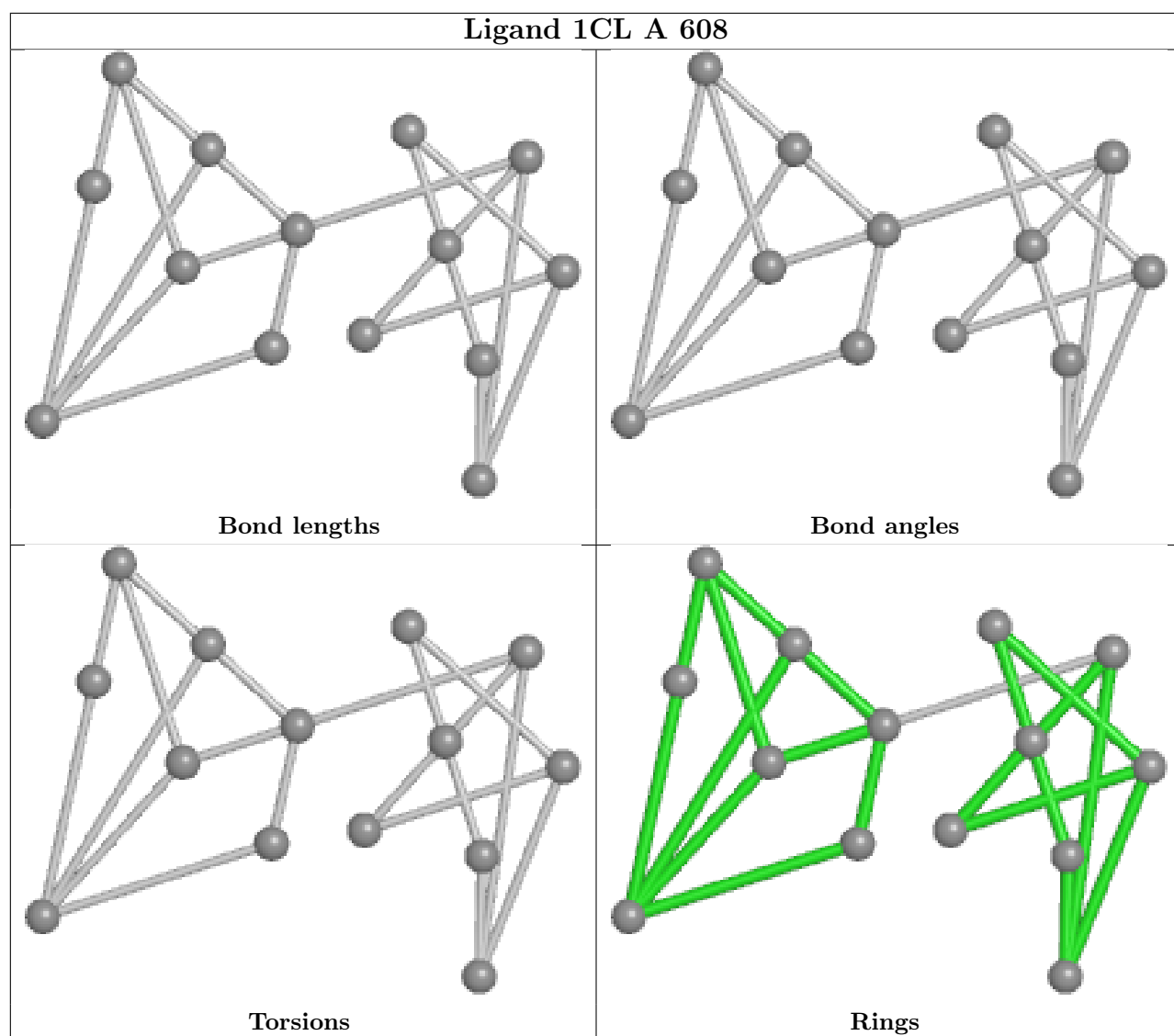

5.7 Other polymers [i](#)

There are no such residues in this entry.

5.8 Polymer linkage issues [i](#)

There are no chain breaks in this entry.

6 Fit of model and data

6.1 Protein, DNA and RNA chains

In the following table, the column labelled ‘#RSRZ > 2’ contains the number (and percentage) of RSRZ outliers, followed by percent RSRZ outliers for the chain as percentile scores relative to all X-ray entries and entries of similar resolution. The OWAB column contains the minimum, median, 95th percentile and maximum values of the occupancy-weighted average B-factor per residue. The column labelled ‘Q < 0.9’ lists the number of (and percentage) of residues with an average occupancy less than 0.9.

Mol	Chain	Analysed	<RSRZ>	#RSRZ>2	OWAB(Å ²)	Q<0.9
1	A	476/492 (96%)	1.06	89 (18%) 1 1	43, 56, 76, 90	2 (0%)
1	C	476/492 (96%)	0.63	41 (8%) 10 9	32, 44, 59, 74	2 (0%)
2	B	522/523 (99%)	0.61	46 (8%) 10 8	33, 50, 66, 82	2 (0%)
2	D	522/523 (99%)	0.50	32 (6%) 21 19	32, 46, 62, 81	0
All	All	1996/2030 (98%)	0.70	208 (10%) 6 5	32, 49, 68, 90	6 (0%)

All (208) RSRZ outliers are listed below:

Mol	Chain	Res	Type	RSRZ
1	A	395	GLY	6.1
1	A	329	ALA	6.0
1	A	125	PHE	5.7
1	A	217	ALA	5.4
1	A	291	GLY	5.2
1	C	124	VAL	4.9
1	C	125	PHE	4.7
2	B	103	PHE	4.7
1	A	292	ILE	4.7
2	B	307	GLY	4.7
1	A	316	PHE	4.5
1	A	319	SER	4.2
2	D	77	LEU	4.1
2	B	73	LEU	4.1
1	A	216	PHE	4.0
2	B	175	ILE	3.9
1	A	124	VAL	3.9
2	B	176	PRO	3.9
1	A	313	ALA	3.8
2	B	174	PHE	3.8
1	A	480	GLU	3.7

Continued on next page...

Continued from previous page...

Mol	Chain	Res	Type	RSRZ
1	A	355	ILE	3.7
1	C	214	THR	3.6
2	B	98	TYR	3.6
1	A	75	ILE	3.6
1	A	327	VAL	3.6
1	A	70	VAL	3.6
2	B	217	VAL	3.6
1	A	300	PHE	3.5
2	D	97	ALA	3.5
1	A	86	VAL	3.5
2	B	69	ALA	3.5
2	B	99	PHE	3.5
1	A	98	ASN	3.5
1	A	17	LEU	3.5
1	A	123	ILE	3.4
2	D	522	VAL	3.4
1	A	231	ILE	3.3
1	C	172	ALA	3.3
2	D	178	GLU	3.3
1	A	16	VAL	3.3
2	B	179	PHE	3.3
1	A	160	GLY	3.3
2	D	98	TYR	3.3
1	A	218	SER	3.2
2	B	77	LEU	3.2
1	C	313	ALA	3.2
1	A	91	TYR	3.2
1	C	175	SER	3.2
1	A	320	ILE	3.2
1	C	314	ALA	3.2
2	B	102	TYR	3.1
1	C	110	VAL	3.1
2	D	103	PHE	3.1
1	C	79	ILE	3.1
2	D	337	GLY	3.1
1	A	229	TYR	3.1
1	A	121	LYS	3.1
1	C	332	LYS	3.1
1	C	70	VAL	3.1
1	A	220	PRO	3.0
1	A	266	PRO	3.0
1	C	75	ILE	3.0

Continued on next page...

Continued from previous page...

Mol	Chain	Res	Type	RSRZ
2	B	474	PHE	3.0
2	D	209	THR	3.0
1	A	358	LEU	3.0
1	A	478	PRO	3.0
1	A	444	TRP	2.9
1	C	231	ILE	2.9
2	D	285	PRO	2.9
2	B	230	PHE	2.9
1	A	290	TYR	2.9
1	C	99	TYR	2.9
1	A	324	CYS	2.9
2	B	177	ASP	2.9
1	A	87	GLY	2.9
2	B	31	PHE	2.9
1	A	219	THR	2.8
1	C	171	GLY	2.8
1	A	64	TYR	2.8
1	A	288	GLU	2.8
2	B	408	ALA	2.8
2	B	171	LYS	2.8
2	D	217	VAL	2.8
2	B	210	LEU	2.8
1	A	95	GLY	2.8
2	D	73	LEU	2.7
1	A	364	ILE	2.7
2	B	173	GLY	2.7
1	A	14	GLN	2.7
1	A	384	ASN	2.7
1	A	71	VAL	2.7
1	A	221	TYR	2.7
1	C	91	TYR	2.7
2	B	5	VAL	2.7
1	A	172	ALA	2.6
2	B	342	ALA	2.6
2	B	337	GLY	2.6
1	C	39	VAL	2.6
1	C	64	TYR	2.6
2	D	339	PRO	2.6
1	A	425	ILE	2.6
2	B	248	GLY	2.6
1	A	363	VAL	2.6
2	D	215	ASP	2.6

Continued on next page...

Continued from previous page...

Mol	Chain	Res	Type	RSRZ
2	D	521	LEU	2.6
1	A	359	ARG	2.6
1	A	73	GLY	2.6
1	A	94	ALA	2.6
1	A	21	PRO	2.6
1	A	174	LEU	2.6
1	A	441	MET	2.6
1	A	212	GLU	2.6
2	D	76	VAL	2.6
2	B	410	LEU	2.5
1	C	355	ILE	2.5
1	C	82	SER	2.5
1	C	441	MET	2.5
2	B	330	MET	2.5
1	A	353	LEU	2.5
1	C	65	ALA	2.5
1	A	89	GLY	2.5
2	B	218	VAL	2.5
2	D	102	TYR	2.5
1	C	98	ASN	2.5
1	A	69	GLY	2.4
2	D	404	LYS	2.4
1	A	112	MET	2.4
1	A	312	ILE	2.4
2	B	473	ILE	2.4
1	A	205	TRP	2.4
1	A	294	TRP	2.4
1	A	318	GLU	2.4
1	C	229	TYR	2.4
2	B	371	GLY	2.4
1	A	79	ILE	2.4
1	A	169	VAL	2.4
2	B	332	VAL	2.4
2	D	38	ASP	2.4
2	D	287	ALA	2.4
2	D	338	GLN	2.4
2	B	212	SER	2.4
1	A	443	SER	2.4
1	A	213	ASP	2.4
2	B	313	VAL	2.4
1	C	353	LEU	2.3
1	A	65	ALA	2.3

Continued on next page...

Continued from previous page...

Mol	Chain	Res	Type	RSRZ
1	A	68	LYS	2.3
1	A	99	TYR	2.3
2	B	107	PHE	2.3
1	A	31	HIS	2.3
2	B	285	PRO	2.3
2	D	197	TRP	2.3
1	A	38	ALA	2.3
1	C	213	ASP	2.3
1	A	11	SER	2.3
2	D	220	SER	2.3
1	A	110	VAL	2.3
1	A	314	ALA	2.3
1	A	165	SER	2.3
1	A	45	CYS	2.3
2	D	171	LYS	2.3
1	C	288	GLU	2.2
1	C	478	PRO	2.2
1	A	92	SER	2.2
1	C	218	SER	2.2
1	A	328	ILE	2.2
1	A	450	TYR	2.2
1	A	214	THR	2.2
2	D	212	SER	2.2
1	A	93	ARG	2.2
2	D	298	LEU	2.2
2	B	462	PHE	2.2
2	D	78	CYS	2.2
1	A	166	VAL	2.2
1	C	86	VAL	2.2
2	D	214	ASP	2.2
2	B	222	LYS	2.2
2	D	288	LEU	2.2
1	C	112	MET	2.2
1	C	215	THR	2.2
1	A	33	ALA	2.2
2	B	89	VAL	2.2
2	D	409	ILE	2.1
1	A	459	PHE	2.1
2	B	333	SER	2.1
2	B	339	PRO	2.1
2	D	173	GLY	2.1
2	D	176	PRO	2.1

Continued on next page...

Continued from previous page...

Mol	Chain	Res	Type	RSRZ
2	B	211	LYS	2.1
1	C	69	GLY	2.1
1	C	174	LEU	2.1
2	B	310	LYS	2.1
1	C	291	GLY	2.1
1	C	111	THR	2.1
2	D	80	LEU	2.1
2	B	167	ASN	2.1
1	A	321	GLN	2.1
1	C	114	PHE	2.1
1	C	150	VAL	2.1
2	B	338	GLN	2.0
2	B	125	PHE	2.0
1	A	97	ARG	2.0
1	C	96	ARG	2.0
1	A	422	GLY	2.0
2	B	411	ALA	2.0
1	C	335	TRP	2.0
1	C	212	GLU	2.0

6.2 Non-standard residues in protein, DNA, RNA chains [i](#)

There are no non-standard protein/DNA/RNA residues in this entry.

6.3 Carbohydrates [i](#)

There are no monosaccharides in this entry.

6.4 Ligands [i](#)

In the following table, the Atoms column lists the number of modelled atoms in the group and the number defined in the chemical component dictionary. The B-factors column lists the minimum, median, 95th percentile and maximum values of B factors of atoms in the group. The column labelled 'Q< 0.9' lists the number of atoms with occupancy less than 0.9.

Mol	Type	Chain	Res	Atoms	RSCC	RSR	B-factors(Å ²)	Q<0.9
7	MO	C	509	1/1	0.50	0.17	86,86,86,86	1
7	MO	B	603	1/1	0.73	0.12	85,85,85,85	1
6	H2S	A	604	1/1	0.80	0.16	88,88,88,88	0
6	H2S	D	603	1/1	0.80	0.08	84,84,84,84	0

Continued on next page...

Continued from previous page...

Mol	Type	Chain	Res	Atoms	RSCC	RSR	B-factors(\AA^2)	Q<0.9
11	PGE	B	606	10/10	0.81	0.18	49,65,72,72	0
10	GOL	C	510	6/6	0.83	0.28	52,63,71,73	0
10	GOL	D	602	6/6	0.86	0.24	35,45,47,50	0
7	MO	D	604	1/1	0.86	0.06	72,72,72,72	1
10	GOL	C	501	6/6	0.87	0.17	34,39,43,46	0
3	HCA	A	601	14/14	0.87	0.21	42,45,49,53	0
10	GOL	D	601	6/6	0.88	0.16	63,65,68,70	0
7	MO	A	605	1/1	0.88	0.07	81,81,81,81	1
3	HCA	C	502	14/14	0.88	0.19	30,38,44,49	0
10	GOL	D	605	6/6	0.89	0.23	51,56,60,60	0
9	FE	B	604	1/1	0.89	0.10	39,39,39,39	1
7	MO	C	507	1/1	0.90	0.07	60,60,60,60	1
6	H2S	C	505	1/1	0.90	0.12	65,65,65,65	0
9	FE	B	607	1/1	0.90	0.14	51,51,51,51	1
5	HDZ	A	603	2/2	0.91	0.26	46,46,46,46	0
5	HDZ	C	511	2/2	0.92	0.23	29,29,29,29	0
10	GOL	B	605	6/6	0.92	0.21	43,50,54,54	0
7	MO	A	606	1/1	0.93	0.09	59,59,59,59	1
6	H2S	B	602	1/1	0.94	0.05	79,79,79,79	0
4	ICE	A	602	17/17	0.94	0.10	44,46,49,50	0
12	ICZ	C	503	16/16	0.94	0.08	29,34,37,40	0
7	MO	A	607	1/1	0.95	0.07	65,65,65,65	1
8	1CL	C	512	15/15	0.95	0.08	31,37,43,51	0
7	MO	C	508	1/1	0.95	0.12	46,46,46,46	1
5	HDZ	C	504	2/2	0.95	0.23	28,28,28,28	0
8	1CL	A	608	15/15	0.96	0.07	45,46,49,57	0
6	H2S	C	506	1/1	0.98	0.15	39,39,39,39	0
6	H2S	B	601	1/1	0.99	0.23	44,44,44,44	0

The following is a graphical depiction of the model fit to experimental electron density of all instances of the Ligand of Interest. In addition, ligands with molecular weight > 250 and outliers as shown on the geometry validation Tables will also be included. Each fit is shown from different orientation to approximate a three-dimensional view.

Electron density around HCA A 601:

$2mF_o-DF_c$ (at 0.7 rmsd) in gray
 mF_o-DF_c (at 3 rmsd) in purple (negative)
and green (positive)

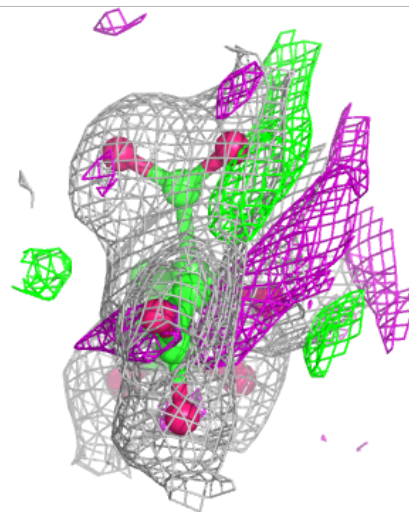
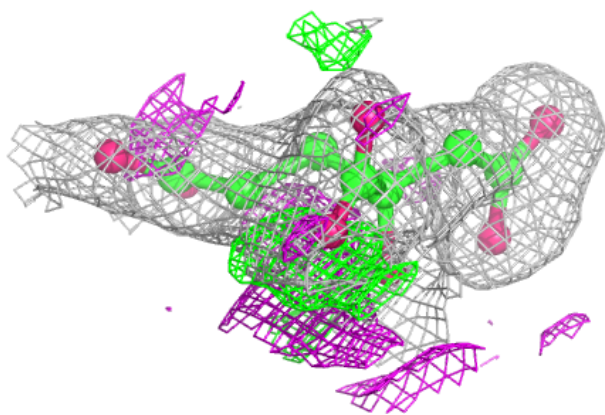
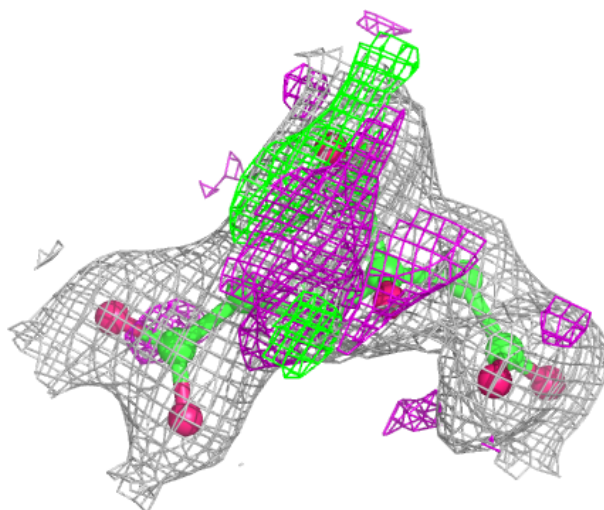

Electron density around HCA C 502:

$2mF_o-DF_c$ (at 0.7 rmsd) in gray
 mF_o-DF_c (at 3 rmsd) in purple (negative)
and green (positive)

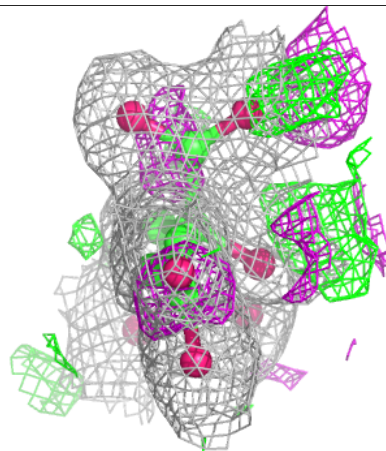
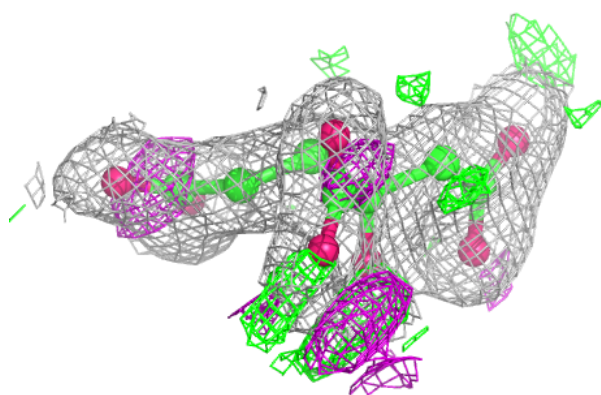
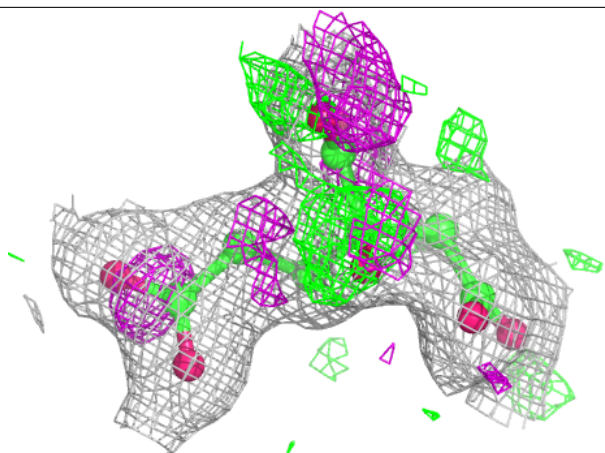

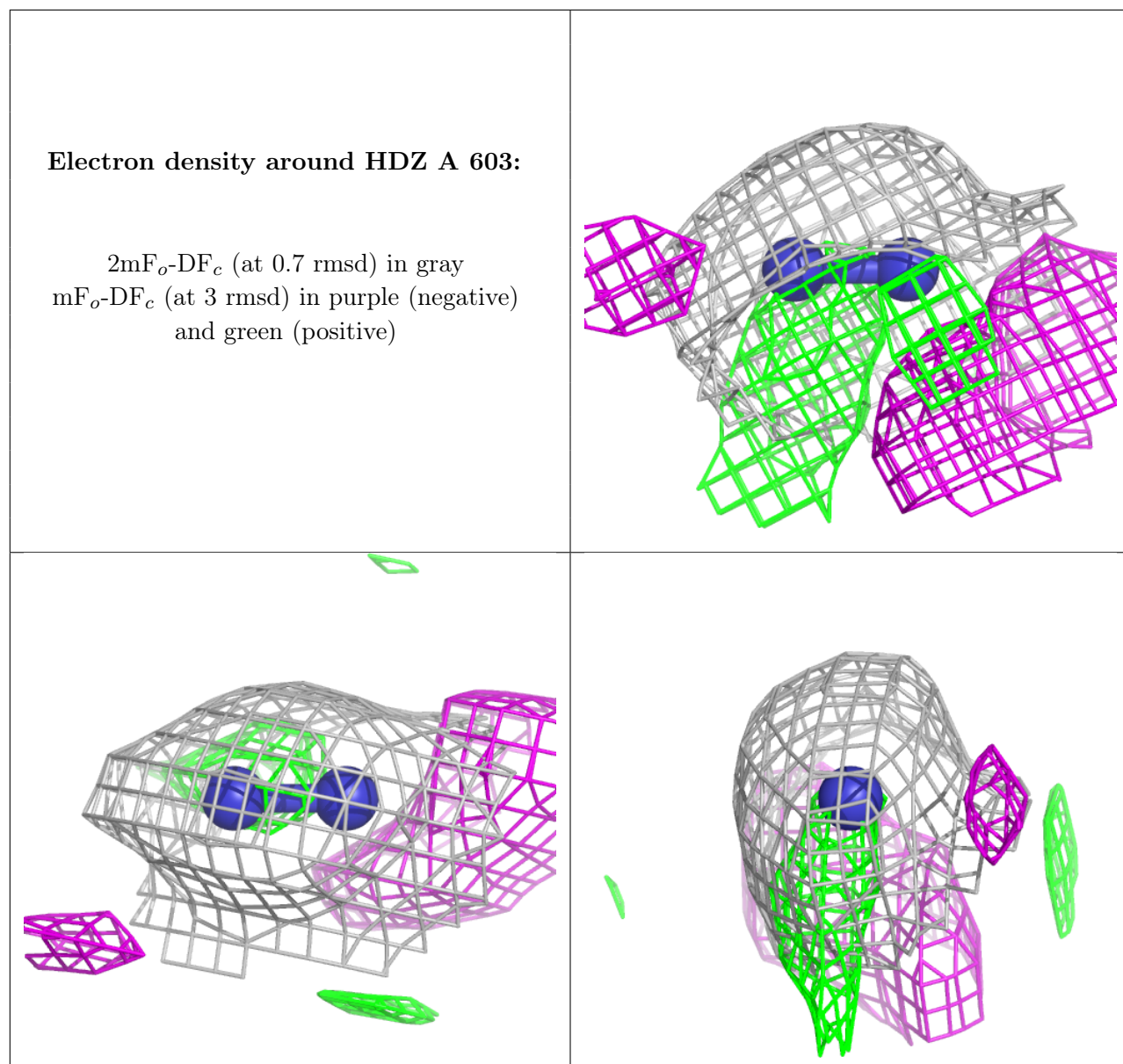

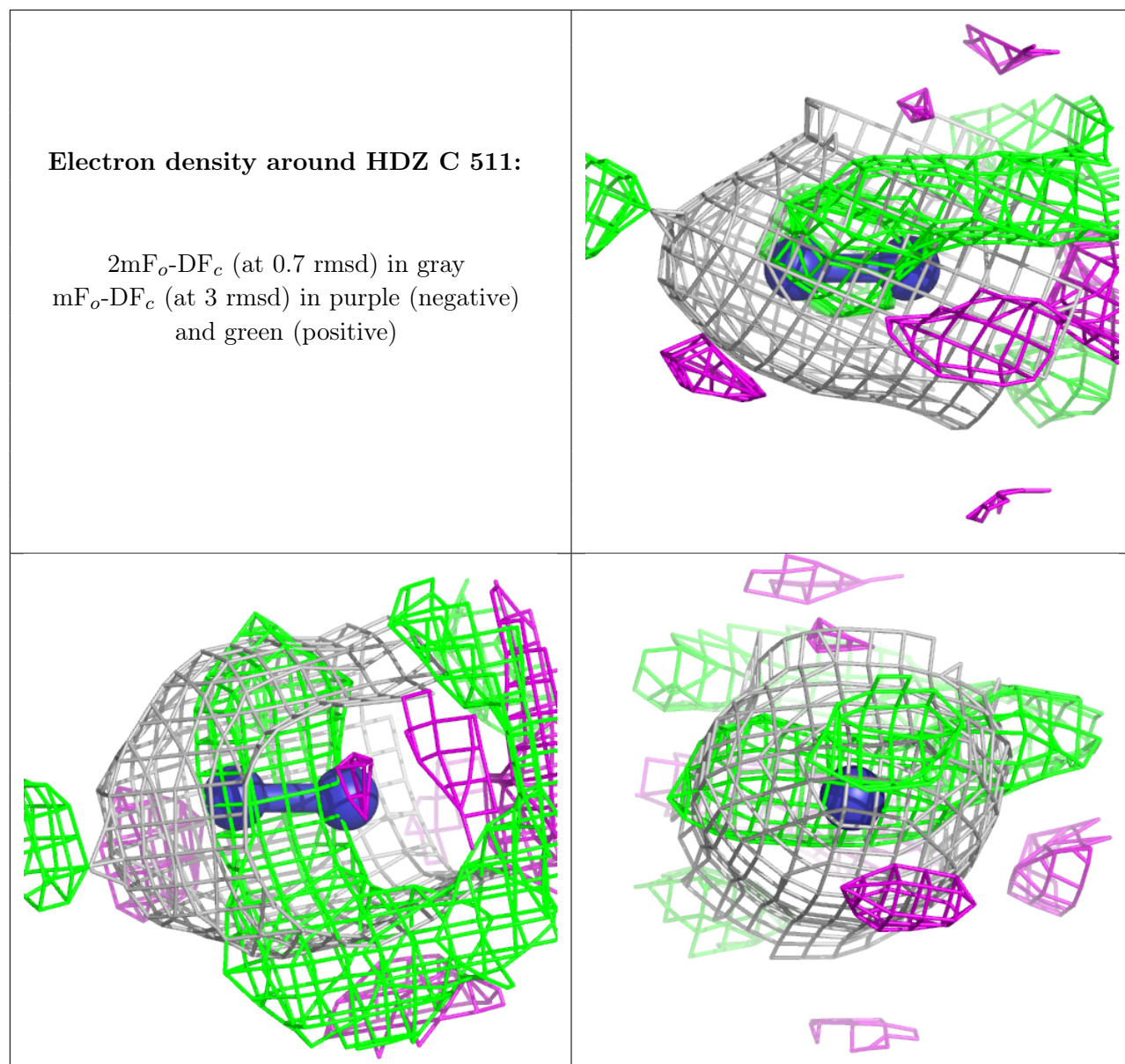

Electron density around ICE A 602:

$2mF_o-DF_c$ (at 0.7 rmsd) in gray
 mF_o-DF_c (at 3 rmsd) in purple (negative)
and green (positive)

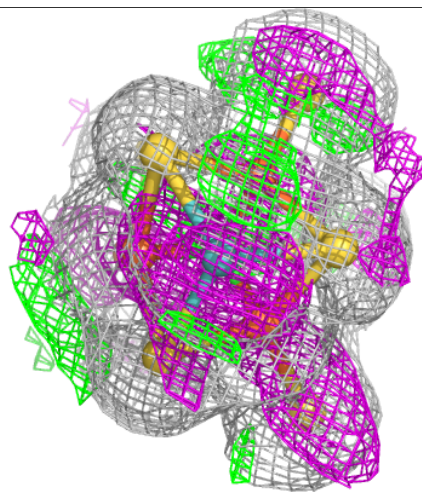
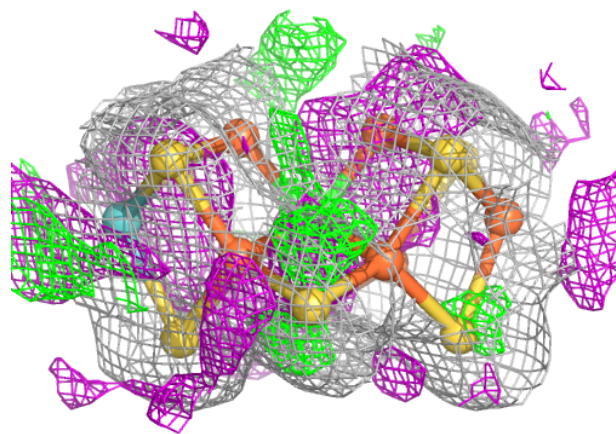
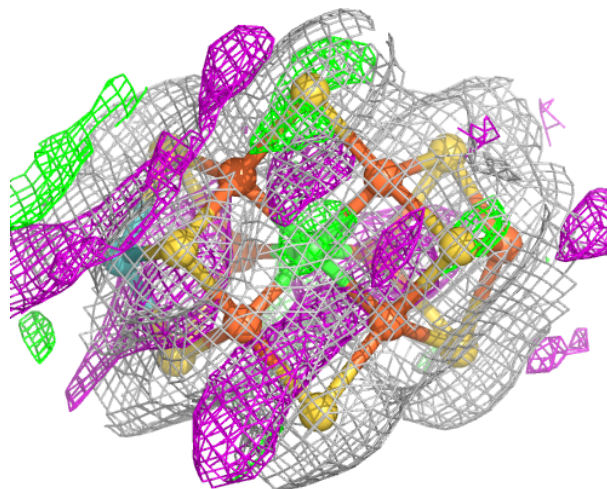

Electron density around ICZ C 503:

$2mF_o-DF_c$ (at 0.7 rmsd) in gray
 mF_o-DF_c (at 3 rmsd) in purple (negative)
and green (positive)

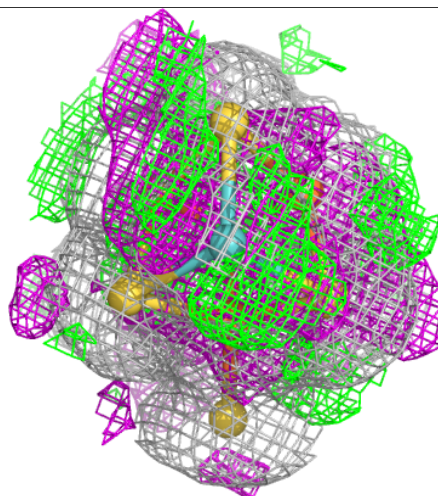
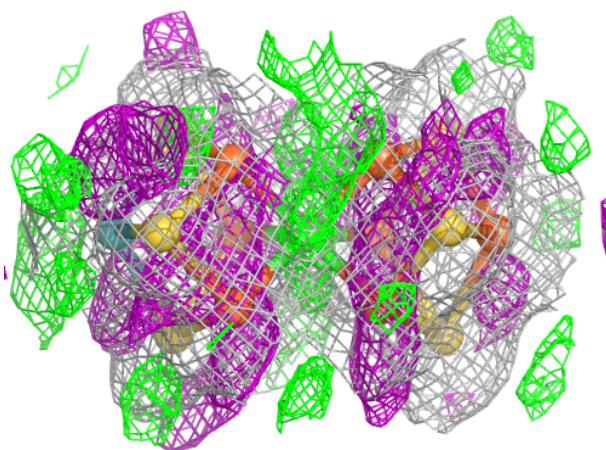
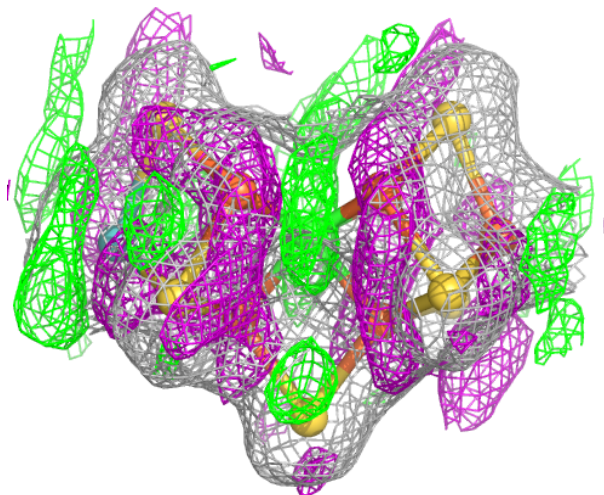

Electron density around 1CL C 512:

$2mF_o-DF_c$ (at 0.7 rmsd) in gray
 mF_o-DF_c (at 3 rmsd) in purple (negative)
and green (positive)

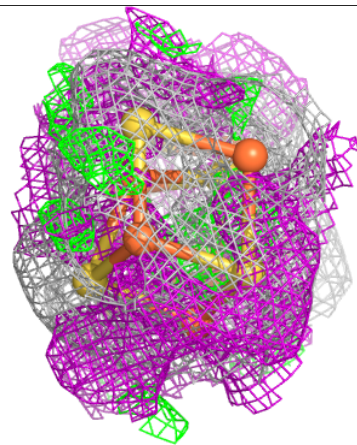
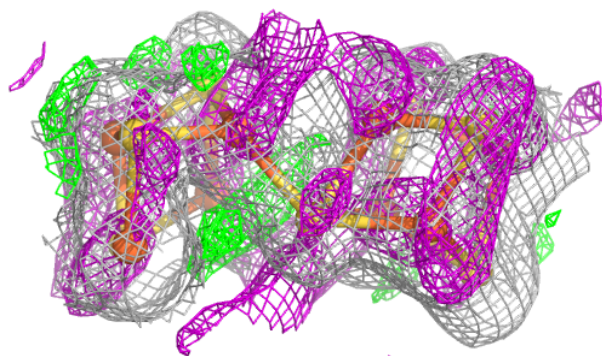
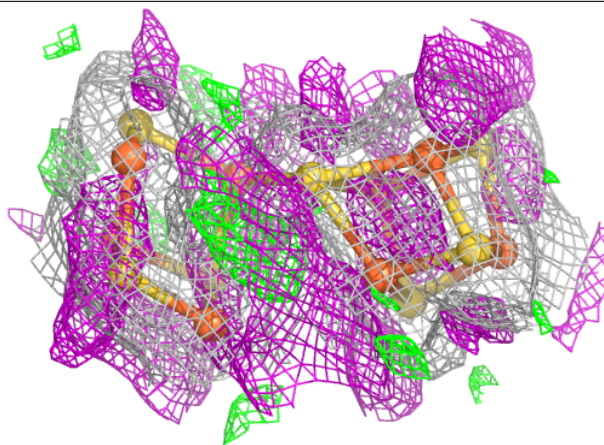

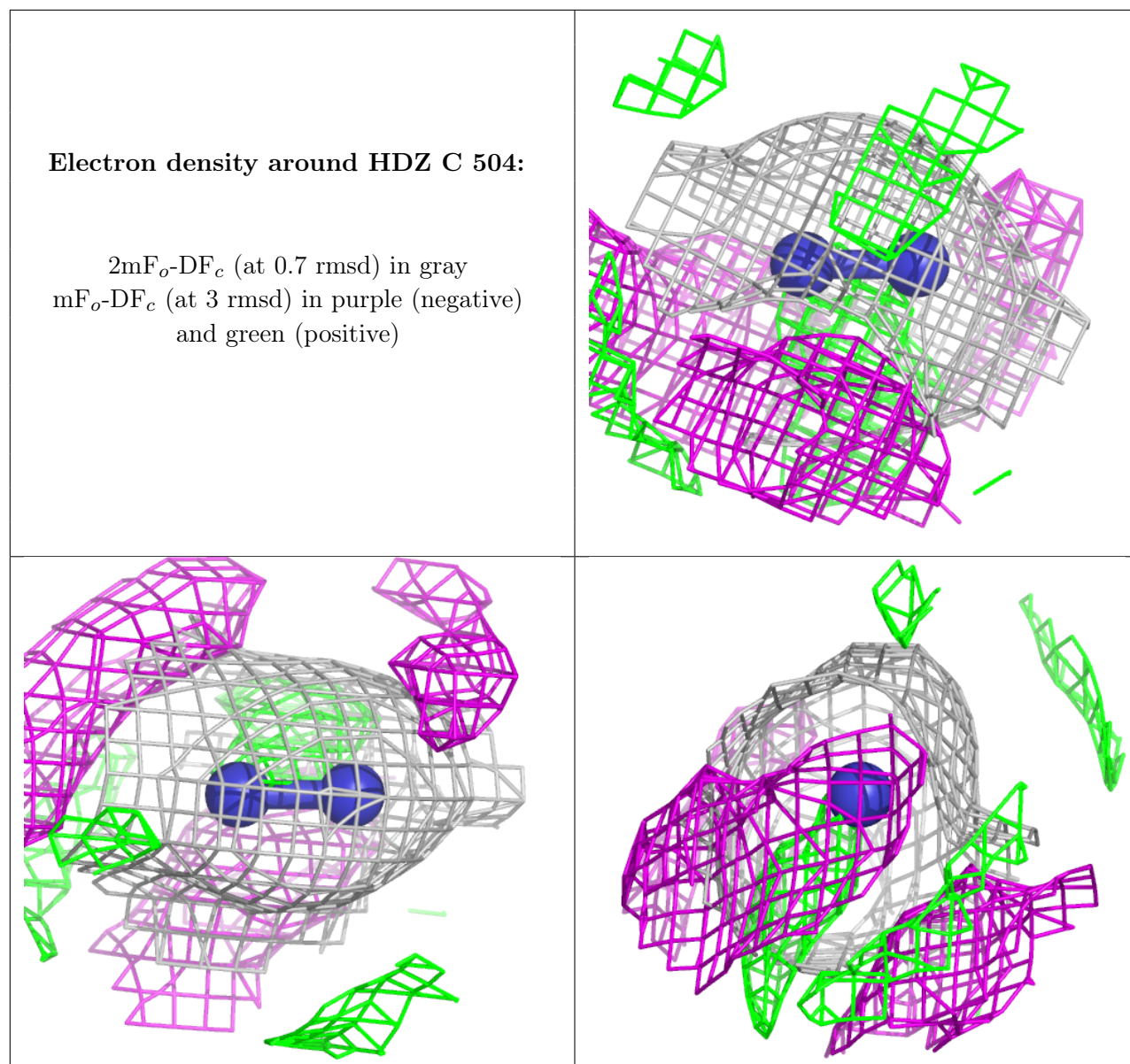

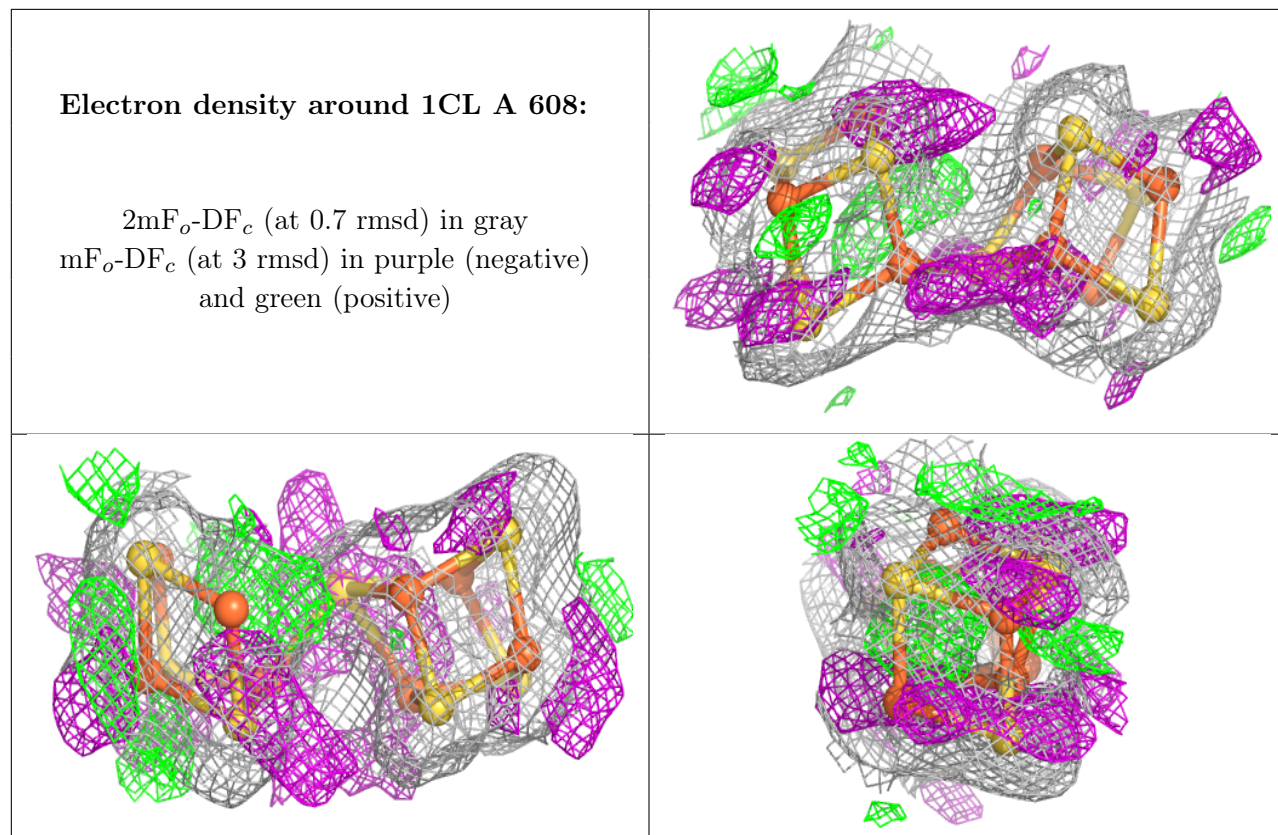

6.5 Other polymers [i](#)

There are no such residues in this entry.