



wwPDB X-ray Structure Validation Summary Report ⓘ

Dec 17, 2023 – 02:48 PM EST

PDB ID : 4TLL
Title : Crystal structure of GluN1/GluN2B NMDA receptor, structure 1
Authors : Gouaux, E.; Lee, C.-H.; Lu, W.
Deposited on : 2014-05-30
Resolution : 3.59 Å(reported)

This is a wwPDB X-ray Structure Validation Summary Report for a publicly released PDB entry.

We welcome your comments at validation@mail.wwpdb.org

A user guide is available at

<https://www.wwpdb.org/validation/2017/XrayValidationReportHelp>

with specific help available everywhere you see the ⓘ symbol.

The types of validation reports are described at

<http://www.wwpdb.org/validation/2017/FAQs#types>.

The following versions of software and data (see [references ⓘ](#)) were used in the production of this report:

MolProbity : 4.02b-467
Mogul : 1.8.5 (274361), CSD as541be (2020)
Xtriage (Phenix) : 1.13
EDS : 2.36
buster-report : 1.1.7 (2018)
Percentile statistics : 20191225.v01 (using entries in the PDB archive December 25th 2019)
Refmac : 5.8.0158
CCP4 : 7.0.044 (Gargrove)
Ideal geometry (proteins) : Engh & Huber (2001)
Ideal geometry (DNA, RNA) : Parkinson et al. (1996)
Validation Pipeline (wwPDB-VP) : 2.36

1 Overall quality at a glance

The following experimental techniques were used to determine the structure:

X-RAY DIFFRACTION

The reported resolution of this entry is 3.59 Å.

Percentile scores (ranging between 0-100) for global validation metrics of the entry are shown in the following graphic. The table shows the number of entries on which the scores are based.

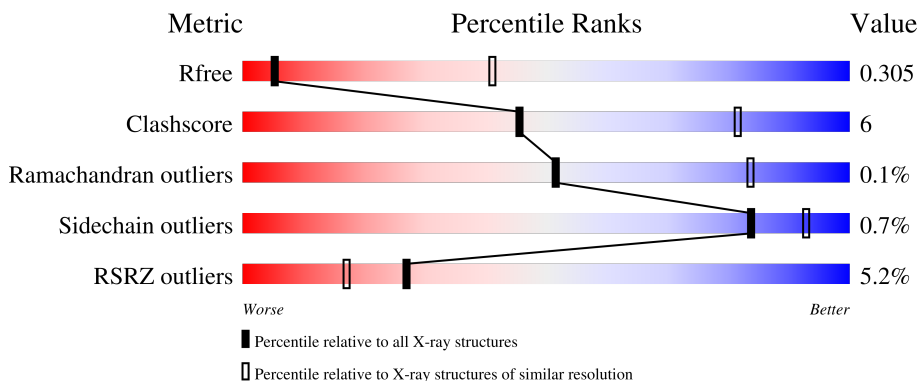

Metric	Whole archive (#Entries)	Similar resolution (#Entries, resolution range(Å))
R_{free}	130704	1257 (3.70-3.50)
Clashscore	141614	1353 (3.70-3.50)
Ramachandran outliers	138981	1307 (3.70-3.50)
Sidechain outliers	138945	1307 (3.70-3.50)
RSRZ outliers	127900	1161 (3.70-3.50)

The table below summarises the geometric issues observed across the polymeric chains and their fit to the electron density. The red, orange, yellow and green segments of the lower bar indicate the fraction of residues that contain outliers for ≥ 3 , 2, 1 and 0 types of geometric quality criteria respectively. A grey segment represents the fraction of residues that are not modelled. The numeric value for each fraction is indicated below the corresponding segment, with a dot representing fractions $\leq 5\%$. The upper red bar (where present) indicates the fraction of residues that have poor fit to the electron density. The numeric value is given above the bar.

Mol	Chain	Length	Quality of chain
1	A	823	 8% 78% 15% 7%
1	C	823	 8% 81% 6% 13%
2	B	824	 5% 77% 12% 10%
2	D	824	 4% 85% 7% 8%

2 Entry composition [i](#)

There are 6 unique types of molecules in this entry. The entry contains 18759 atoms, of which 0 are hydrogens and 0 are deuteriums.

In the tables below, the ZeroOcc column contains the number of atoms modelled with zero occupancy, the AltConf column contains the number of residues with at least one atom in alternate conformation and the Trace column contains the number of residues modelled with at most 2 atoms.

- Molecule 1 is a protein called receptor subunit GluN1.

Mol	Chain	Residues	Atoms					ZeroOcc	AltConf	Trace
			Total	C	N	O	S			
1	A	767	5208	3300	915	969	24	0	0	0
1	C	719	4193	2583	787	808	15	0	0	0

There are 62 discrepancies between the modelled and reference sequences:

Chain	Residue	Modelled	Actual	Comment	Reference
A	22	ALA	CYS	engineered mutation	UNP C0KD18
A	51	PHE	LYS	engineered mutation	UNP C0KD18
A	52	PHE	ARG	engineered mutation	UNP C0KD18
A	300	GLN	ASN	engineered mutation	UNP C0KD18
A	350	GLN	ASN	engineered mutation	UNP C0KD18
A	368	ASP	ASN	engineered mutation	UNP C0KD18
A	440	ASP	ASN	engineered mutation	UNP C0KD18
A	469	ASP	ASN	engineered mutation	UNP C0KD18
A	493	ALA	LYS	engineered mutation	UNP C0KD18
A	494	ALA	LYS	engineered mutation	UNP C0KD18
A	495	ALA	GLU	engineered mutation	UNP C0KD18
A	602	ARG	GLY	engineered mutation	UNP C0KD18
A	609	LEU	ILE	engineered mutation	UNP C0KD18
A	648	ARG	ASP	engineered mutation	UNP C0KD18
A	761	GLU	ASN	engineered mutation	UNP C0KD18
A	829	SER	-	insertion	UNP C0KD18
A	830	ARG	-	insertion	UNP C0KD18
A	831	ALA	-	insertion	UNP C0KD18
A	832	GLU	-	insertion	UNP C0KD18
A	833	ALA	-	insertion	UNP C0KD18
A	834	LYS	-	insertion	UNP C0KD18
A	835	ARG	-	insertion	UNP C0KD18
A	836	MET	-	insertion	UNP C0KD18
A	837	LYS	-	insertion	UNP C0KD18
A	838	GLY	-	expression tag	UNP C0KD18

Continued on next page...

Continued from previous page...

Chain	Residue	Modelled	Actual	Comment	Reference
A	839	LEU	-	expression tag	UNP C0KD18
A	840	GLU	-	expression tag	UNP C0KD18
A	841	VAL	-	expression tag	UNP C0KD18
A	842	LEU	-	expression tag	UNP C0KD18
A	843	PHE	-	expression tag	UNP C0KD18
A	844	GLN	-	expression tag	UNP C0KD18
C	22	ALA	CYS	engineered mutation	UNP C0KD18
C	51	PHE	LYS	engineered mutation	UNP C0KD18
C	52	PHE	ARG	engineered mutation	UNP C0KD18
C	300	GLN	ASN	engineered mutation	UNP C0KD18
C	350	GLN	ASN	engineered mutation	UNP C0KD18
C	368	ASP	ASN	engineered mutation	UNP C0KD18
C	440	ASP	ASN	engineered mutation	UNP C0KD18
C	469	ASP	ASN	engineered mutation	UNP C0KD18
C	493	ALA	LYS	engineered mutation	UNP C0KD18
C	494	ALA	LYS	engineered mutation	UNP C0KD18
C	495	ALA	GLU	engineered mutation	UNP C0KD18
C	602	ARG	GLY	engineered mutation	UNP C0KD18
C	609	LEU	ILE	engineered mutation	UNP C0KD18
C	648	ARG	ASP	engineered mutation	UNP C0KD18
C	761	GLU	ASN	engineered mutation	UNP C0KD18
C	829	SER	-	insertion	UNP C0KD18
C	830	ARG	-	insertion	UNP C0KD18
C	831	ALA	-	insertion	UNP C0KD18
C	832	GLU	-	insertion	UNP C0KD18
C	833	ALA	-	insertion	UNP C0KD18
C	834	LYS	-	insertion	UNP C0KD18
C	835	ARG	-	insertion	UNP C0KD18
C	836	MET	-	insertion	UNP C0KD18
C	837	LYS	-	insertion	UNP C0KD18
C	838	GLY	-	expression tag	UNP C0KD18
C	839	LEU	-	expression tag	UNP C0KD18
C	840	GLU	-	expression tag	UNP C0KD18
C	841	VAL	-	expression tag	UNP C0KD18
C	842	LEU	-	expression tag	UNP C0KD18
C	843	PHE	-	expression tag	UNP C0KD18
C	844	GLN	-	expression tag	UNP C0KD18

- Molecule 2 is a protein called receptor subunit GluN2B.

Mol	Chain	Residues	Atoms					ZeroOcc	AltConf	Trace
			Total	C	N	O	S			
2	B	738	4669	2924	812	910	23	0	0	0

Continued on next page...

Continued from previous page...

Mol	Chain	Residues	Atoms					ZeroOcc	AltConf	Trace
			Total	C	N	O	S			
2	D	757	4565	2856	808	882	19	0	0	0

There are 58 discrepancies between the modelled and reference sequences:

Chain	Residue	Modelled	Actual	Comment	Reference
B	20	SER	MET	engineered mutation	UNP A7XY94
B	21	ARG	GLY	engineered mutation	UNP A7XY94
B	22	ALA	CYS	engineered mutation	UNP A7XY94
B	64	GLU	ALA	engineered mutation	UNP A7XY94
B	69	GLN	ASN	engineered mutation	UNP A7XY94
B	216	CYS	LYS	engineered mutation	UNP A7XY94
B	343	ASP	ASN	engineered mutation	UNP A7XY94
B	486	VAL	THR	engineered mutation	UNP A7XY94
B	601	LEU	VAL	engineered mutation	UNP A7XY94
B	640	ARG	GLU	engineered mutation	UNP A7XY94
B	641	ARG	GLU	engineered mutation	UNP A7XY94
B	826	TYR	-	insertion	UNP A7XY94
B	827	LYS	-	insertion	UNP A7XY94
B	828	SER	-	insertion	UNP A7XY94
B	829	ARG	-	insertion	UNP A7XY94
B	830	ALA	-	insertion	UNP A7XY94
B	831	GLU	-	insertion	UNP A7XY94
B	832	ALA	-	insertion	UNP A7XY94
B	833	LYS	-	insertion	UNP A7XY94
B	834	ARG	-	insertion	UNP A7XY94
B	835	MET	-	insertion	UNP A7XY94
B	836	LYS	-	insertion	UNP A7XY94
B	837	GLY	-	expression tag	UNP A7XY94
B	838	LEU	-	expression tag	UNP A7XY94
B	839	GLU	-	expression tag	UNP A7XY94
B	840	VAL	-	expression tag	UNP A7XY94
B	841	LEU	-	expression tag	UNP A7XY94
B	842	PHE	-	expression tag	UNP A7XY94
B	843	GLN	-	expression tag	UNP A7XY94
D	20	SER	MET	engineered mutation	UNP A7XY94
D	21	ARG	GLY	engineered mutation	UNP A7XY94
D	22	ALA	CYS	engineered mutation	UNP A7XY94
D	64	GLU	ALA	engineered mutation	UNP A7XY94
D	69	GLN	ASN	engineered mutation	UNP A7XY94
D	216	CYS	LYS	engineered mutation	UNP A7XY94
D	343	ASP	ASN	engineered mutation	UNP A7XY94

Continued on next page...

Continued from previous page...

Chain	Residue	Modelled	Actual	Comment	Reference
D	486	VAL	THR	engineered mutation	UNP A7XY94
D	601	LEU	VAL	engineered mutation	UNP A7XY94
D	640	ARG	GLU	engineered mutation	UNP A7XY94
D	641	ARG	GLU	engineered mutation	UNP A7XY94
D	826	TYR	-	insertion	UNP A7XY94
D	827	LYS	-	insertion	UNP A7XY94
D	828	SER	-	insertion	UNP A7XY94
D	829	ARG	-	insertion	UNP A7XY94
D	830	ALA	-	insertion	UNP A7XY94
D	831	GLU	-	insertion	UNP A7XY94
D	832	ALA	-	insertion	UNP A7XY94
D	833	LYS	-	insertion	UNP A7XY94
D	834	ARG	-	insertion	UNP A7XY94
D	835	MET	-	insertion	UNP A7XY94
D	836	LYS	-	insertion	UNP A7XY94
D	837	GLY	-	expression tag	UNP A7XY94
D	838	LEU	-	expression tag	UNP A7XY94
D	839	GLU	-	expression tag	UNP A7XY94
D	840	VAL	-	expression tag	UNP A7XY94
D	841	LEU	-	expression tag	UNP A7XY94
D	842	PHE	-	expression tag	UNP A7XY94
D	843	GLN	-	expression tag	UNP A7XY94

- Molecule 3 is 2-acetamido-2-deoxy-beta-D-glucopyranose (three-letter code: NAG) (formula: $C_8H_{15}NO_6$).

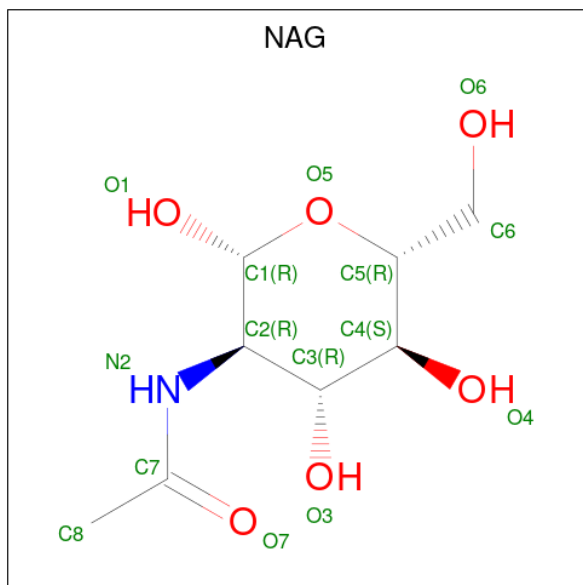

Mol	Chain	Residues	Atoms				ZeroOcc	AltConf
3	A	1	Total	C	N	O	0	0
			14	8	1	5		
3	A	1	Total	C	N	O	0	0
			14	8	1	5		
3	A	1	Total	C	N	O	0	0
			14	8	1	5		
3	B	1	Total	C	N	O	0	0
			14	8	1	5		

- Molecule 4 is 1-AMINOCYCLOPROPANECARBOXYLIC ACID (three-letter code: 1AC) (formula: C₄H₇NO₂).

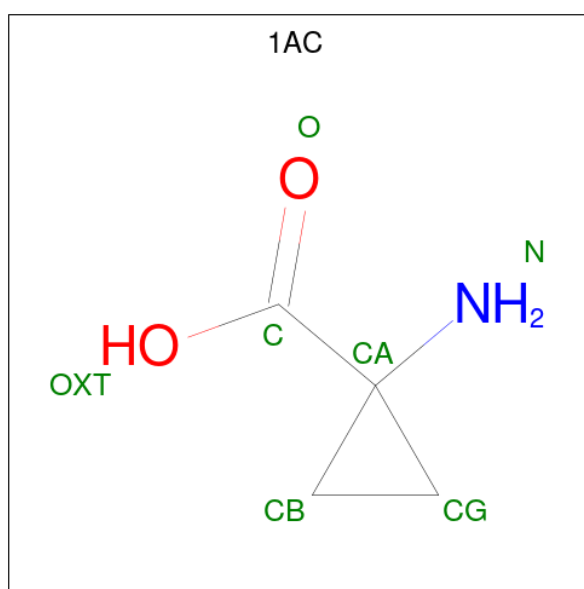

Mol	Chain	Residues	Atoms				ZeroOcc	AltConf
4	A	1	Total	C	N	O	0	0
			7	4	1	2		

- Molecule 5 is 4-[(1R,2S)-3-(4-benzylpiperidin-1-yl)-1-hydroxy-2-methylpropyl]phenol (three-letter code: QEM) (formula: C₂₂H₂₉NO₂).

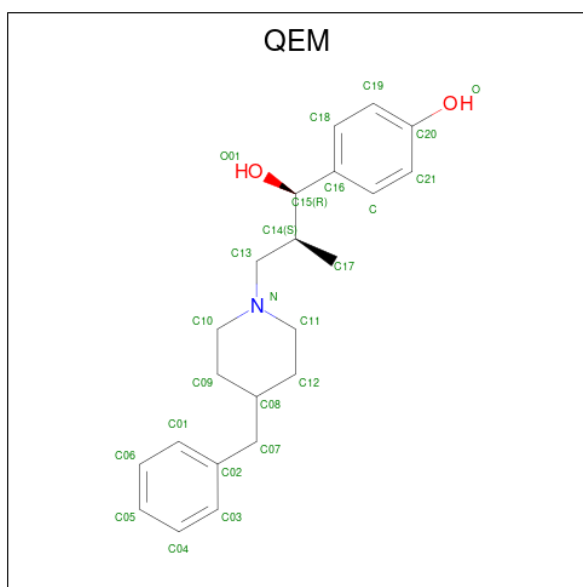

Mol	Chain	Residues	Atoms				ZeroOcc	AltConf
			Total	C	N	O		
5	B	1	25	22	1	2	0	0
5	D	1	25	22	1	2	0	0

- Molecule 6 is trans-1-aminocyclobutane-1,3-dicarboxylic acid (three-letter code: JEG) (formula: $C_6H_9NO_4$).

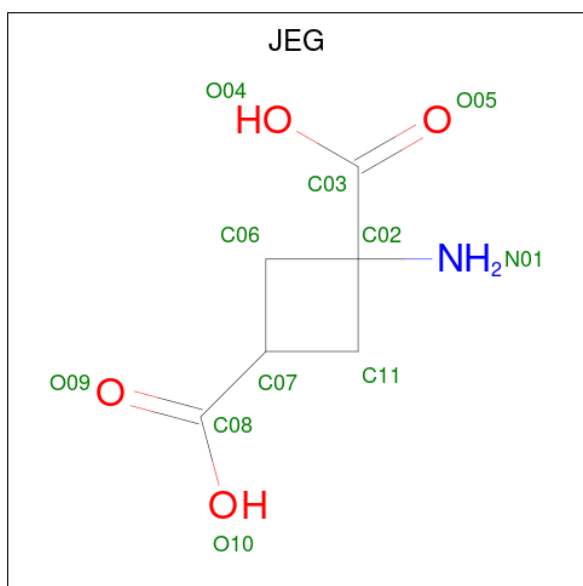

Mol	Chain	Residues	Atoms				ZeroOcc	AltConf
			Total	C	N	O		
6	D	1	11	6	1	4	0	0

3 Residue-property plots [i](#)

These plots are drawn for all protein, RNA, DNA and oligosaccharide chains in the entry. The first graphic for a chain summarises the proportions of the various outlier classes displayed in the second graphic. The second graphic shows the sequence view annotated by issues in geometry and electron density. Residues are color-coded according to the number of geometric quality criteria for which they contain at least one outlier: green = 0, yellow = 1, orange = 2 and red = 3 or more. A red dot above a residue indicates a poor fit to the electron density ($RSRZ > 2$). Stretches of 2 or more consecutive residues without any outlier are shown as a green connector. Residues present in the sample, but not in the model, are shown in grey.

- Molecule 1: receptor subunit GluN1

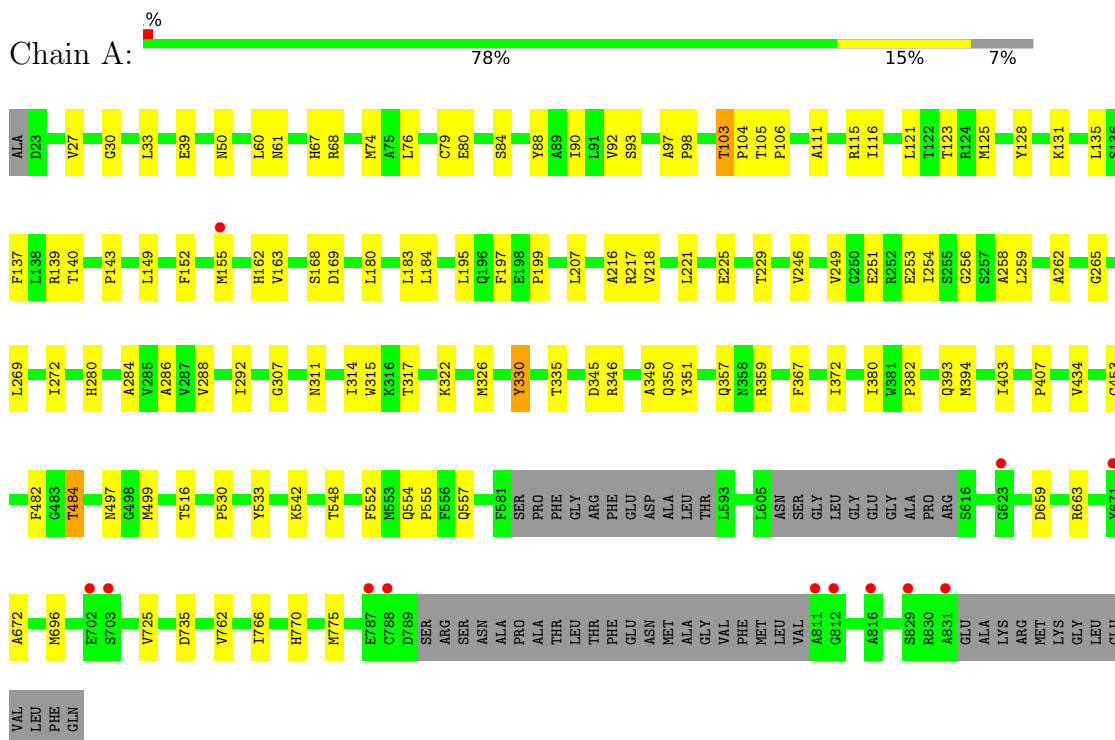

- Molecule 1: receptor subunit GluN1

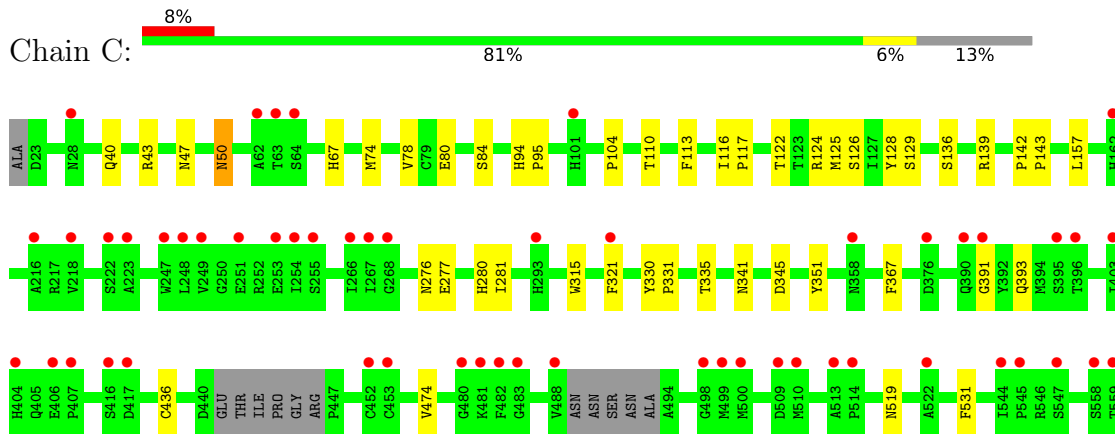

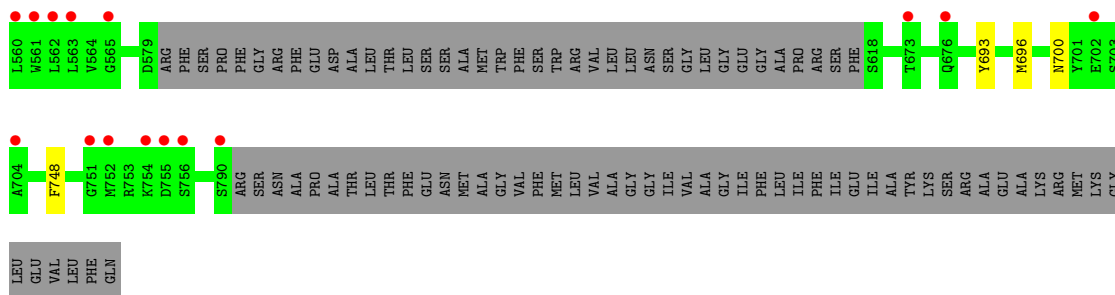

● Molecule 2: receptor subunit GluN2B

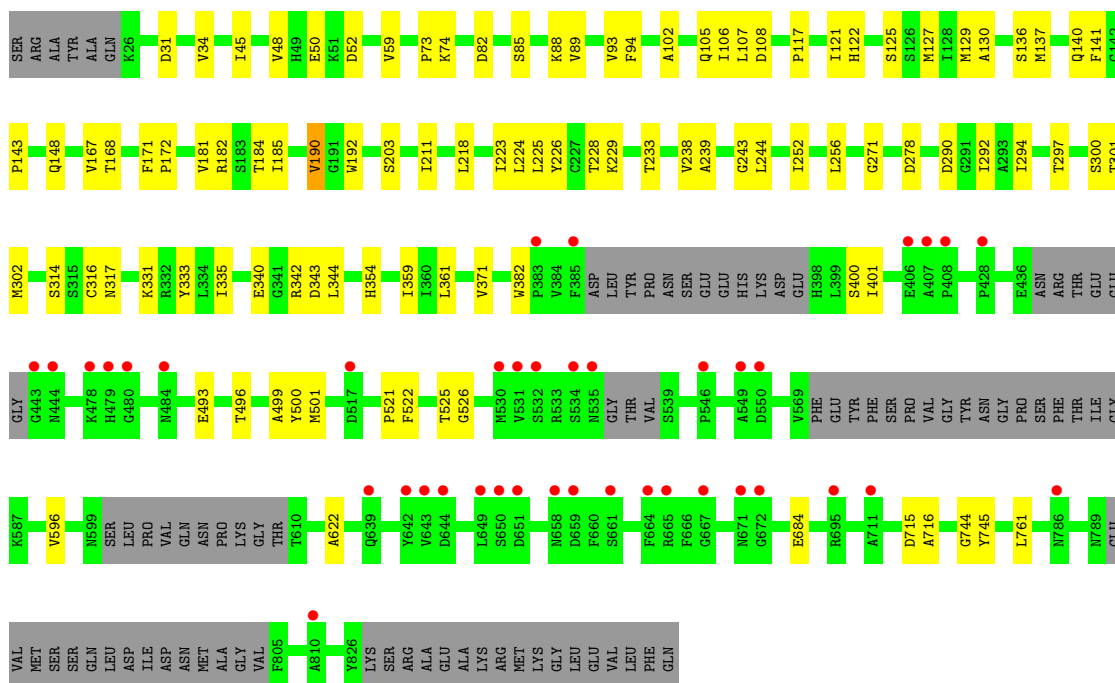
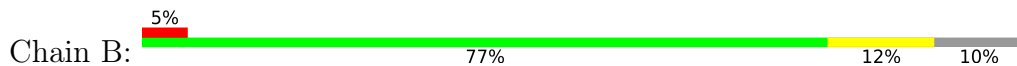

● Molecule 2: receptor subunit GluN2B

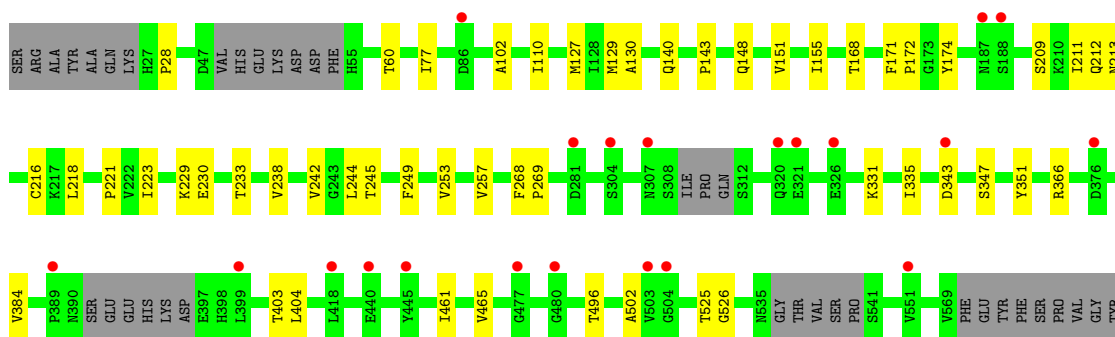
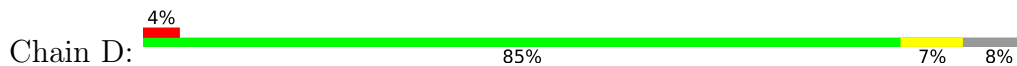

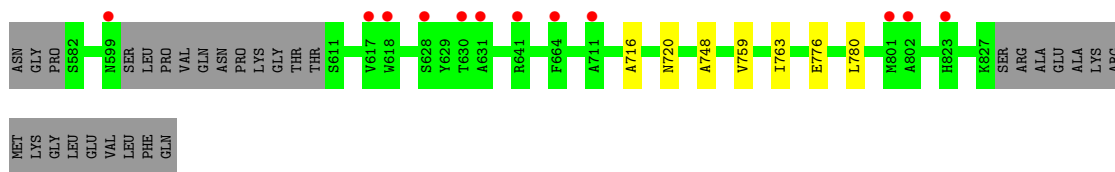

4 Data and refinement statistics i

Property	Value	Source
Space group	C 1 2 1	Depositor
Cell constants a, b, c, α , β , γ	201.46Å 117.26Å 218.76Å 90.00° 106.70° 90.00°	Depositor
Resolution (Å)	48.08 – 3.59 48.08 – 3.50	Depositor EDS
% Data completeness (in resolution range)	93.2 (48.08-3.59) 88.6 (48.08-3.50)	Depositor EDS
R_{merge}	(Not available)	Depositor
R_{sym}	(Not available)	Depositor
$\langle I/\sigma(I) \rangle$ ¹	2.04 (at 3.48Å)	Xtrriage
Refinement program	PHENIX (phenix.refine: 1.9_1692)	Depositor
R, R_{free}	0.266 , 0.305 0.268 , 0.305	Depositor DCC
R_{free} test set	2720 reflections (4.97%)	wwPDB-VP
Wilson B-factor (Å ²)	88.3	Xtrriage
Anisotropy	0.074	Xtrriage
Bulk solvent k_{sol} (e/Å ³), B_{sol} (Å ²)	0.15 , 143.0	EDS
L-test for twinning ²	$\langle L \rangle = 0.37$, $\langle L^2 \rangle = 0.19$	Xtrriage
Estimated twinning fraction	0.099 for $1/2^*h+3/2^*k, 1/2^*h-1/2^*k, -1/2^*h-1/2^*k-l$ 0.110 for $1/2^*h-3/2^*k, -1/2^*h-1/2^*k, -1/2^*h+1/2^*k-l$	Xtrriage
F_o, F_c correlation	0.81	EDS
Total number of atoms	18759	wwPDB-VP
Average B, all atoms (Å ²)	196.0	wwPDB-VP

Xtrriage's analysis on translational NCS is as follows: *The largest off-origin peak in the Patterson function is 3.38% of the height of the origin peak. No significant pseudotranslation is detected.*

¹Intensities estimated from amplitudes.

²Theoretical values of $\langle |L| \rangle$, $\langle L^2 \rangle$ for acentric reflections are 0.5, 0.333 respectively for untwinned datasets, and 0.375, 0.2 for perfectly twinned datasets.

5 Model quality [i](#)

5.1 Standard geometry [i](#)

Bond lengths and bond angles in the following residue types are not validated in this section: 1AC, JEG, NAG, QEM

The Z score for a bond length (or angle) is the number of standard deviations the observed value is removed from the expected value. A bond length (or angle) with $|Z| > 5$ is considered an outlier worth inspection. RMSZ is the root-mean-square of all Z scores of the bond lengths (or angles).

Mol	Chain	Bond lengths		Bond angles	
		RMSZ	# Z >5	RMSZ	# Z >5
1	A	0.24	0/5317	0.47	0/7290
1	C	0.22	0/4265	0.44	0/5906
2	B	0.24	0/4743	0.47	0/6531
2	D	0.23	0/4638	0.44	0/6405
All	All	0.23	0/18963	0.46	0/26132

There are no bond length outliers.

There are no bond angle outliers.

There are no chirality outliers.

There are no planarity outliers.

5.2 Too-close contacts [i](#)

In the following table, the Non-H and H(model) columns list the number of non-hydrogen atoms and hydrogen atoms in the chain respectively. The H(added) column lists the number of hydrogen atoms added and optimized by MolProbity. The Clashes column lists the number of clashes within the asymmetric unit, whereas Symm-Clashes lists symmetry-related clashes.

Mol	Chain	Non-H	H(model)	H(added)	Clashes	Symm-Clashes
1	A	5208	0	4360	84	0
1	C	4193	0	2746	31	0
2	B	4669	0	3509	64	0
2	D	4565	0	3142	34	0
3	A	42	0	39	0	0
3	B	14	0	13	1	0
4	A	7	0	6	1	0
5	B	25	0	29	1	0
5	D	25	0	29	3	0

Continued on next page...

Continued from previous page...

Mol	Chain	Non-H	H(model)	H(added)	Clashes	Symm-Clashes
6	D	11	0	6	0	0
All	All	18759	0	13879	209	0

The all-atom clashscore is defined as the number of clashes found per 1000 atoms (including hydrogen atoms). The all-atom clashscore for this structure is 6.

The worst 5 of 209 close contacts within the same asymmetric unit are listed below, sorted by their clash magnitude.

Atom-1	Atom-2	Interatomic distance (Å)	Clash overlap (Å)
1:A:125:MET:O	1:A:139:ARG:NH2	2.09	0.85
1:A:79:CYS:SG	2:B:74:LYS:HB2	2.20	0.81
2:D:502:ALA:HB3	2:D:748:ALA:HB3	1.65	0.77
2:D:143:PRO:HG2	2:D:148:GLN:HE21	1.54	0.71
2:B:290:ASP:OD1	2:B:342:ARG:NH2	2.16	0.70

There are no symmetry-related clashes.

5.3 Torsion angles [i](#)

5.3.1 Protein backbone [i](#)

In the following table, the Percentiles column shows the percent Ramachandran outliers of the chain as a percentile score with respect to all X-ray entries followed by that with respect to entries of similar resolution.

The Analysed column shows the number of residues for which the backbone conformation was analysed, and the total number of residues.

Mol	Chain	Analysed	Favoured	Allowed	Outliers	Percentiles	
1	A	759/823 (92%)	732 (96%)	27 (4%)	0	100	100
1	C	711/823 (86%)	686 (96%)	25 (4%)	0	100	100
2	B	724/824 (88%)	690 (95%)	33 (5%)	1 (0%)	51	83
2	D	743/824 (90%)	703 (95%)	39 (5%)	1 (0%)	51	83
All	All	2937/3294 (89%)	2811 (96%)	124 (4%)	2 (0%)	51	83

All (2) Ramachandran outliers are listed below:

Mol	Chain	Res	Type
2	B	48	VAL

Continued on next page...

Continued from previous page...

Mol	Chain	Res	Type
2	D	384	VAL

5.3.2 Protein sidechains [i](#)

In the following table, the Percentiles column shows the percent sidechain outliers of the chain as a percentile score with respect to all X-ray entries followed by that with respect to entries of similar resolution.

The Analysed column shows the number of residues for which the sidechain conformation was analysed, and the total number of residues.

Mol	Chain	Analysed	Rotameric	Outliers	Percentiles	
1	A	410/705 (58%)	407 (99%)	3 (1%)	84	93
1	C	191/705 (27%)	190 (100%)	1 (0%)	88	95
2	B	308/724 (42%)	305 (99%)	3 (1%)	76	88
2	D	241/724 (33%)	240 (100%)	1 (0%)	91	97
All	All	1150/2858 (40%)	1142 (99%)	8 (1%)	84	93

5 of 8 residues with a non-rotameric sidechain are listed below:

Mol	Chain	Res	Type
2	D	496	THR
1	C	50	ASN
2	B	190	VAL
2	B	184	THR
2	B	382	TRP

Sometimes sidechains can be flipped to improve hydrogen bonding and reduce clashes. All (2) such sidechains are listed below:

Mol	Chain	Res	Type
1	C	280	HIS
2	D	148	GLN

5.3.3 RNA [i](#)

There are no RNA molecules in this entry.

5.4 Non-standard residues in protein, DNA, RNA chains [i](#)

There are no non-standard protein/DNA/RNA residues in this entry.

5.5 Carbohydrates [i](#)

There are no monosaccharides in this entry.

5.6 Ligand geometry [i](#)

8 ligands are modelled in this entry.

In the following table, the Counts columns list the number of bonds (or angles) for which Mogul statistics could be retrieved, the number of bonds (or angles) that are observed in the model and the number of bonds (or angles) that are defined in the Chemical Component Dictionary. The Link column lists molecule types, if any, to which the group is linked. The Z score for a bond length (or angle) is the number of standard deviations the observed value is removed from the expected value. A bond length (or angle) with $|Z| > 2$ is considered an outlier worth inspection. RMSZ is the root-mean-square of all Z scores of the bond lengths (or angles).

Mol	Type	Chain	Res	Link	Bond lengths			Bond angles		
					Counts	RMSZ	# Z > 2	Counts	RMSZ	# Z > 2
3	NAG	A	903	1	14,14,15	0.32	0	17,19,21	0.40	0
5	QEM	B	901	-	27,27,27	0.81	1 (3%)	35,36,36	1.22	4 (11%)
5	QEM	D	901	-	27,27,27	0.83	2 (7%)	35,36,36	1.16	4 (11%)
6	JEG	D	902	-	7,11,11	2.60	3 (42%)	10,17,17	2.26	3 (30%)
4	1AC	A	904	-	3,7,7	1.06	0	6,11,11	2.86	3 (50%)
3	NAG	B	902	2	14,14,15	0.30	0	17,19,21	0.38	0
3	NAG	A	901	1	14,14,15	0.23	0	17,19,21	0.34	0
3	NAG	A	902	1	14,14,15	0.73	1 (7%)	17,19,21	1.04	1 (5%)

In the following table, the Chirals column lists the number of chiral outliers, the number of chiral centers analysed, the number of these observed in the model and the number defined in the Chemical Component Dictionary. Similar counts are reported in the Torsion and Rings columns. '-' means no outliers of that kind were identified.

Mol	Type	Chain	Res	Link	Chirals	Torsions	Rings
3	NAG	A	903	1	-	2/6/23/26	0/1/1/1
5	QEM	B	901	-	-	6/16/26/26	0/3/3/3
5	QEM	D	901	-	-	4/16/26/26	0/3/3/3
6	JEG	D	902	-	-	4/9/20/20	0/1/1/1
4	1AC	A	904	-	-	2/4/10/10	0/1/1/1

Continued on next page...

Continued from previous page...

Mol	Type	Chain	Res	Link	Chirals	Torsions	Rings
3	NAG	B	902	2	-	2/6/23/26	0/1/1/1
3	NAG	A	901	1	-	2/6/23/26	0/1/1/1
3	NAG	A	902	1	-	2/6/23/26	0/1/1/1

The worst 5 of 7 bond length outliers are listed below:

Mol	Chain	Res	Type	Atoms	Z	Observed(Å)	Ideal(Å)
6	D	902	JEG	C07-C08	-4.02	1.44	1.51
6	D	902	JEG	C11-C07	-3.60	1.50	1.54
6	D	902	JEG	C06-C07	-3.40	1.50	1.54
3	A	902	NAG	O5-C1	2.60	1.47	1.43
5	D	901	QEM	O-C20	2.08	1.41	1.37

The worst 5 of 15 bond angle outliers are listed below:

Mol	Chain	Res	Type	Atoms	Z	Observed(°)	Ideal(°)
6	D	902	JEG	C06-C07-C08	5.64	129.10	116.64
4	A	904	1AC	CG-CA-CB	5.20	61.81	59.26
3	A	902	NAG	C1-O5-C5	4.02	117.63	112.19
5	D	901	QEM	C11-N-C10	3.45	116.59	108.83
5	B	901	QEM	C11-N-C10	3.44	116.58	108.83

There are no chirality outliers.

5 of 24 torsion outliers are listed below:

Mol	Chain	Res	Type	Atoms
4	A	904	1AC	OXT-C-CA-CB
4	A	904	1AC	O-C-CA-CB
5	D	901	QEM	C13-C14-C15-O01
3	B	902	NAG	C4-C5-C6-O6
3	B	902	NAG	O5-C5-C6-O6

There are no ring outliers.

4 monomers are involved in 6 short contacts:

Mol	Chain	Res	Type	Clashes	Symm-Clashes
5	B	901	QEM	1	0
5	D	901	QEM	3	0
4	A	904	1AC	1	0
3	B	902	NAG	1	0

The following is a two-dimensional graphical depiction of Mogul quality analysis of bond lengths, bond angles, torsion angles, and ring geometry for all instances of the Ligand of Interest. In addition, ligands with molecular weight > 250 and outliers as shown on the validation Tables will also be included. For torsion angles, if less than 5% of the Mogul distribution of torsion angles is within 10 degrees of the torsion angle in question, then that torsion angle is considered an outlier. Any bond that is central to one or more torsion angles identified as an outlier by Mogul will be highlighted in the graph. For rings, the root-mean-square deviation (RMSD) between the ring in question and similar rings identified by Mogul is calculated over all ring torsion angles. If the average RMSD is greater than 60 degrees and the minimal RMSD between the ring in question and any Mogul-identified rings is also greater than 60 degrees, then that ring is considered an outlier. The outliers are highlighted in purple. The color gray indicates Mogul did not find sufficient equivalents in the CSD to analyse the geometry.

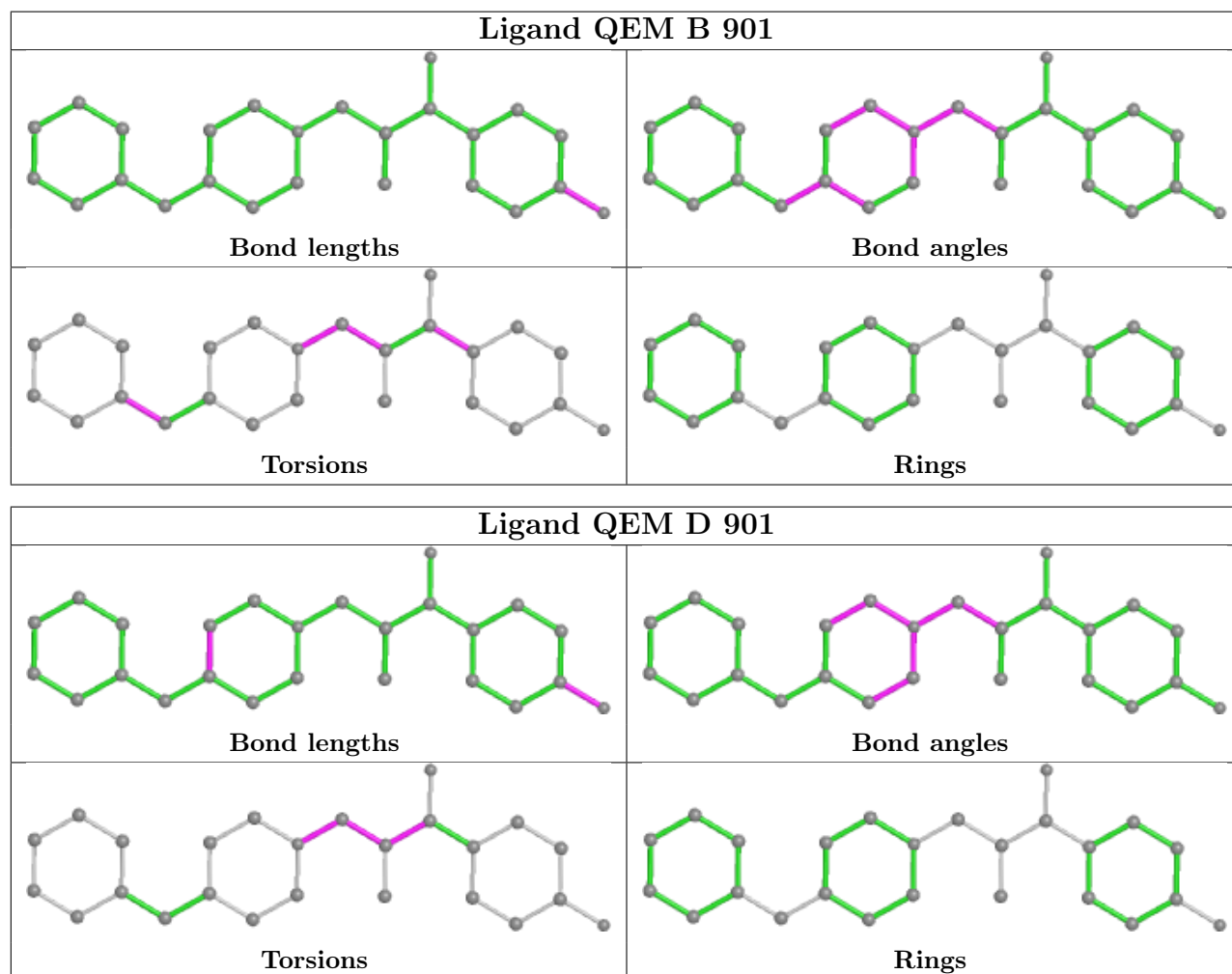

5.7 Other polymers [\(i\)](#)

There are no such residues in this entry.

5.8 Polymer linkage issues

There are no chain breaks in this entry.

6 Fit of model and data [i](#)

6.1 Protein, DNA and RNA chains [i](#)

In the following table, the column labelled ‘#RSRZ> 2’ contains the number (and percentage) of RSRZ outliers, followed by percent RSRZ outliers for the chain as percentile scores relative to all X-ray entries and entries of similar resolution. The OWAB column contains the minimum, median, 95th percentile and maximum values of the occupancy-weighted average B-factor per residue. The column labelled ‘Q< 0.9’ lists the number of (and percentage) of residues with an average occupancy less than 0.9.

Mol	Chain	Analysed	<RSRZ>	#RSRZ>2	OWAB(Å ²)	Q<0.9
1	A	767/823 (93%)	-0.41	12 (1%) 72 57	39, 141, 337, 448	0
1	C	719/823 (87%)	0.14	69 (9%) 8 4	120, 244, 345, 411	0
2	B	738/824 (89%)	-0.16	40 (5%) 25 16	55, 210, 392, 457	0
2	D	757/824 (91%)	-0.11	33 (4%) 34 21	95, 212, 312, 376	0
All	All	2981/3294 (90%)	-0.14	154 (5%) 27 17	39, 206, 356, 457	0

The worst 5 of 154 RSRZ outliers are listed below:

Mol	Chain	Res	Type	RSRZ
2	B	480	GLY	11.5
1	C	482	PHE	8.8
2	D	504	GLY	8.4
1	C	755	ASP	8.2
1	C	752	MET	8.1

6.2 Non-standard residues in protein, DNA, RNA chains [i](#)

There are no non-standard protein/DNA/RNA residues in this entry.

6.3 Carbohydrates [i](#)

There are no monosaccharides in this entry.

6.4 Ligands [i](#)

In the following table, the Atoms column lists the number of modelled atoms in the group and the number defined in the chemical component dictionary. The B-factors column lists the minimum, median, 95th percentile and maximum values of B factors of atoms in the group. The column labelled ‘Q< 0.9’ lists the number of atoms with occupancy less than 0.9.

Mol	Type	Chain	Res	Atoms	RSCC	RSR	B-factors(\AA^2)	Q<0.9
6	JEG	D	902	11/11	0.82	0.46	106,204,205,205	0
3	NAG	B	902	14/15	0.85	0.32	115,129,138,149	0
3	NAG	A	902	14/15	0.90	0.15	114,141,154,164	0
4	1AC	A	904	7/7	0.90	0.18	128,137,163,166	0
3	NAG	A	903	14/15	0.90	0.14	103,119,125,127	0
5	QEM	D	901	25/25	0.92	0.31	88,112,139,147	0
3	NAG	A	901	14/15	0.93	0.23	103,112,122,128	0
5	QEM	B	901	25/25	0.97	0.18	0,38,59,61	0

The following is a graphical depiction of the model fit to experimental electron density of all instances of the Ligand of Interest. In addition, ligands with molecular weight > 250 and outliers as shown on the geometry validation Tables will also be included. Each fit is shown from different orientation to approximate a three-dimensional view.

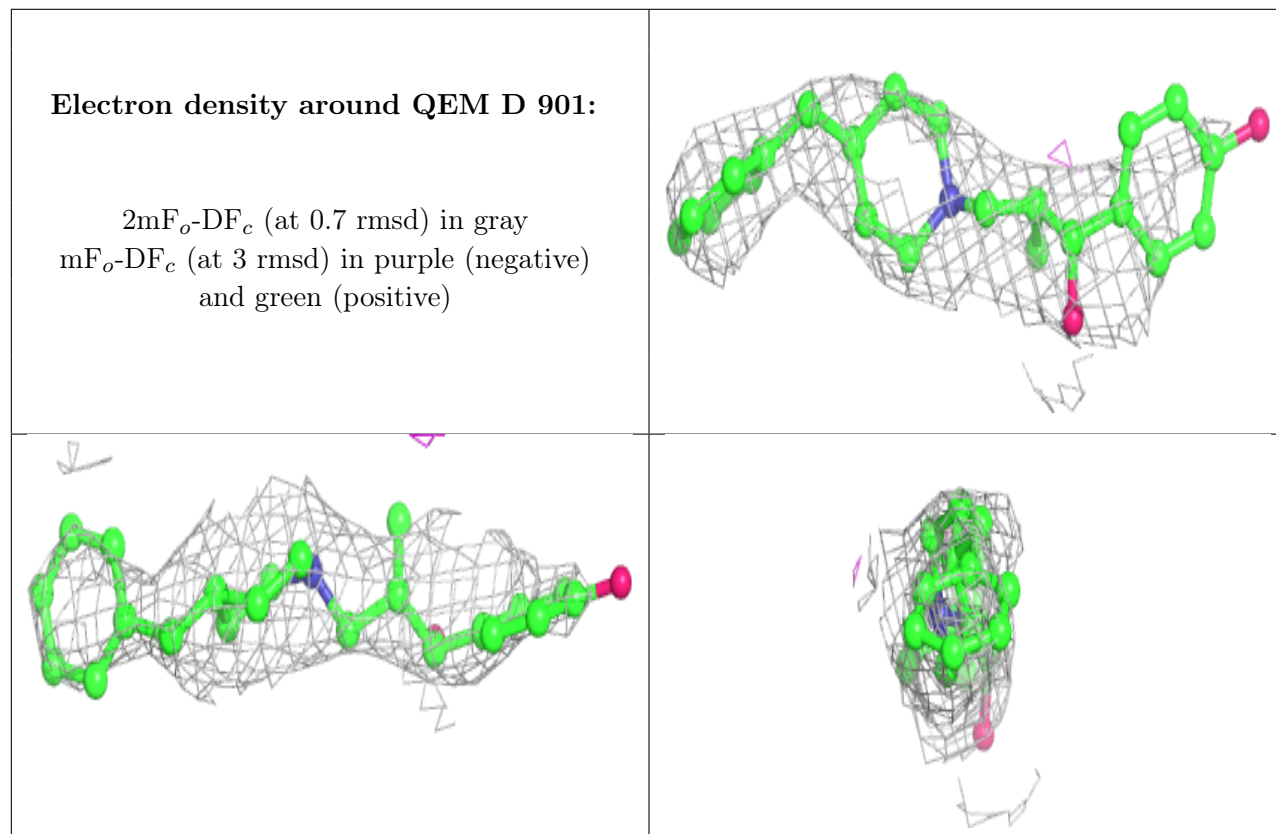

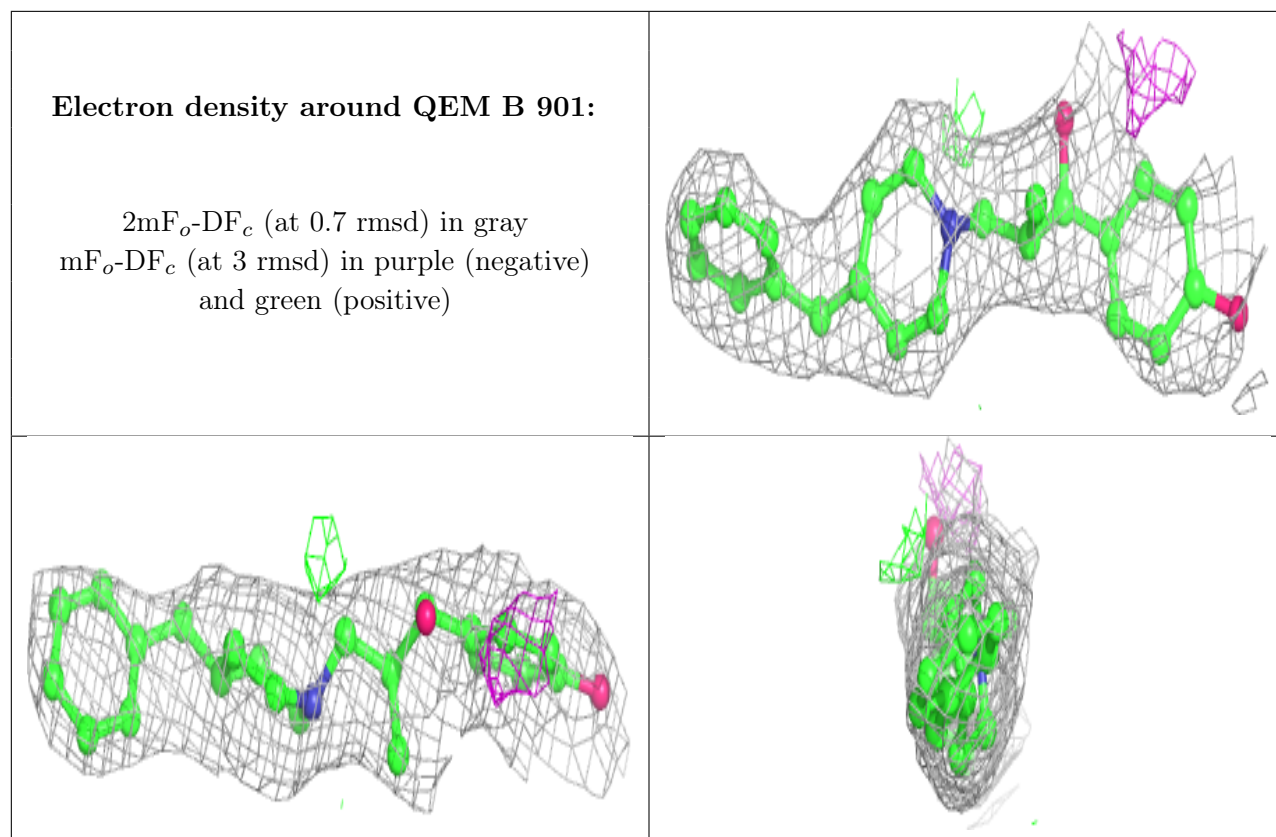

6.5 Other polymers [i](#)

There are no such residues in this entry.