



# Full wwPDB X-ray Structure Validation Report ⓘ

Feb 28, 2024 – 09:22 PM EST

PDB ID : 5S4O  
Title : Tubulin-Z48847594-complex  
Authors : Muehlethaler, T.; Gioia, D.; Prota, A.E.; Sharpe, M.E.; Cavalli, A.; Steinmetz, M.O.  
Deposited on : 2020-11-08  
Resolution : 2.30 Å(reported)

This is a Full wwPDB X-ray Structure Validation Report for a publicly released PDB entry.

We welcome your comments at [validation@mail.wwpdb.org](mailto:validation@mail.wwpdb.org)

A user guide is available at

<https://www.wwpdb.org/validation/2017/XrayValidationReportHelp>

with specific help available everywhere you see the ⓘ symbol.

The types of validation reports are described at

<http://www.wwpdb.org/validation/2017/FAQs#types>.

---

The following versions of software and data (see [references ⓘ](#)) were used in the production of this report:

MolProbity : 4.02b-467  
Mogul : 1.8.5 (274361), CSD as541be (2020)  
Xtriage (Phenix) : 1.13  
EDS : 2.36  
buster-report : 1.1.7 (2018)  
Percentile statistics : 20191225.v01 (using entries in the PDB archive December 25th 2019)  
Refmac : 5.8.0158  
CCP4 : 7.0.044 (Gargrove)  
Ideal geometry (proteins) : Engh & Huber (2001)  
Ideal geometry (DNA, RNA) : Parkinson et al. (1996)  
Validation Pipeline (wwPDB-VP) : 2.36

# 1 Overall quality at a glance i

The following experimental techniques were used to determine the structure:

*X-RAY DIFFRACTION*

The reported resolution of this entry is 2.30 Å.

Percentile scores (ranging between 0-100) for global validation metrics of the entry are shown in the following graphic. The table shows the number of entries on which the scores are based.

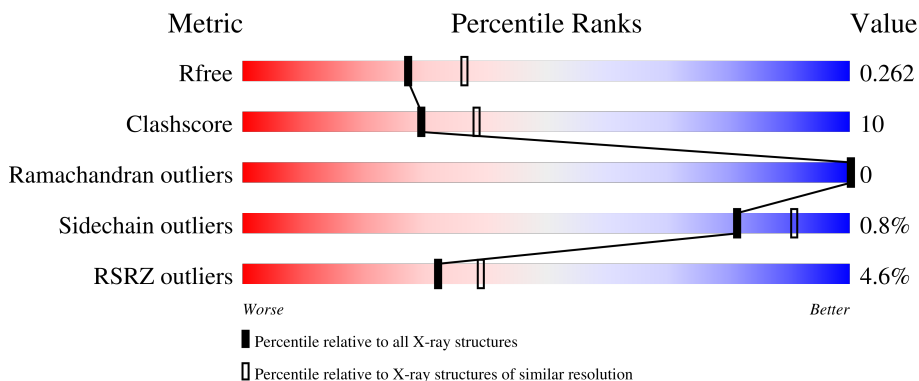

Metric	Whole archive (#Entries)	Similar resolution (#Entries, resolution range(Å))
$R_{free}$	130704	5042 (2.30-2.30)
Clashscore	141614	5643 (2.30-2.30)
Ramachandran outliers	138981	5575 (2.30-2.30)
Sidechain outliers	138945	5575 (2.30-2.30)
RSRZ outliers	127900	4938 (2.30-2.30)

The table below summarises the geometric issues observed across the polymeric chains and their fit to the electron density. The red, orange, yellow and green segments of the lower bar indicate the fraction of residues that contain outliers for  $\geq 3$ , 2, 1 and 0 types of geometric quality criteria respectively. A grey segment represents the fraction of residues that are not modelled. The numeric value for each fraction is indicated below the corresponding segment, with a dot representing fractions  $\leq 5\%$ . The upper red bar (where present) indicates the fraction of residues that have poor fit to the electron density. The numeric value is given above the bar.

Mol	Chain	Length	Quality of chain
1	A	451	<div style="display: flex; align-items: center;"> <div style="width: 2%; height: 10px; background-color: red; margin-right: 2px;"></div> <div style="width: 77%; height: 10px; background-color: green; margin-right: 2px;"></div> <div style="width: 19%; height: 10px; background-color: yellow; margin-right: 2px;"></div> <div style="width: 2%; height: 10px; background-color: grey; margin-right: 2px;"></div> </div> <p style="margin-left: 20px;">2%      77%      19%      .</p>
1	C	451	<div style="display: flex; align-items: center;"> <div style="width: 0%; height: 10px; background-color: red; margin-right: 2px;"></div> <div style="width: 78%; height: 10px; background-color: green; margin-right: 2px;"></div> <div style="width: 19%; height: 10px; background-color: yellow; margin-right: 2px;"></div> <div style="width: 2%; height: 10px; background-color: grey; margin-right: 2px;"></div> </div> <p style="margin-left: 20px;">%      78%      19%      .</p>
2	B	445	<div style="display: flex; align-items: center;"> <div style="width: 3%; height: 10px; background-color: red; margin-right: 2px;"></div> <div style="width: 73%; height: 10px; background-color: green; margin-right: 2px;"></div> <div style="width: 21%; height: 10px; background-color: yellow; margin-right: 2px;"></div> <div style="width: 5%; height: 10px; background-color: grey; margin-right: 2px;"></div> </div> <p style="margin-left: 20px;">3%      73%      21%      5%</p>
2	D	445	<div style="display: flex; align-items: center;"> <div style="width: 2%; height: 10px; background-color: red; margin-right: 2px;"></div> <div style="width: 76%; height: 10px; background-color: green; margin-right: 2px;"></div> <div style="width: 19%; height: 10px; background-color: yellow; margin-right: 2px;"></div> <div style="width: 2%; height: 10px; background-color: grey; margin-right: 2px;"></div> </div> <p style="margin-left: 20px;">2%      76%      19%      .</p>
3	E	143	<div style="display: flex; align-items: center;"> <div style="width: 5%; height: 10px; background-color: red; margin-right: 2px;"></div> <div style="width: 71%; height: 10px; background-color: green; margin-right: 2px;"></div> <div style="width: 15%; height: 10px; background-color: yellow; margin-right: 2px;"></div> <div style="width: 14%; height: 10px; background-color: grey; margin-right: 2px;"></div> </div> <p style="margin-left: 20px;">5%      71%      15%      14%</p>

*Continued on next page...*

*Continued from previous page...*

Mol	Chain	Length	Quality of chain
4	F	384	 <p>A horizontal bar chart representing the quality of chain. The bar is divided into four segments: a red segment on the left labeled '15%', a large green segment labeled '70%', a yellow segment labeled '21%', and a small grey segment on the far right labeled '8%'.</p>

## 2 Entry composition i

There are 12 unique types of molecules in this entry. The entry contains 18132 atoms, of which 22 are hydrogens and 0 are deuteriums.

In the tables below, the ZeroOcc column contains the number of atoms modelled with zero occupancy, the AltConf column contains the number of residues with at least one atom in alternate conformation and the Trace column contains the number of residues modelled with at most 2 atoms.

- Molecule 1 is a protein called Tubulin alpha-1B chain.

Mol	Chain	Residues	Atoms					ZeroOcc	AltConf	Trace
			Total	C	N	O	S			
1	A	437	Total	C	N	O	S	0	0	0
			3416	2163	581	650	22			
1	C	440	Total	C	N	O	S	0	2	0
			3451	2182	586	660	23			

- Molecule 2 is a protein called Tubulin beta-2B chain.

Mol	Chain	Residues	Atoms					ZeroOcc	AltConf	Trace
			Total	C	N	O	S			
2	B	424	Total	C	N	O	S	1	1	0
			3348	2103	573	645	27			
2	D	426	Total	C	N	O	S	5	0	0
			3343	2098	570	648	27			

- Molecule 3 is a protein called Stathmin-4.

Mol	Chain	Residues	Atoms					ZeroOcc	AltConf	Trace
			Total	C	N	O	S			
3	E	123	Total	C	N	O	S	0	0	0
			1014	625	183	201	5			

There are 2 discrepancies between the modelled and reference sequences:

Chain	Residue	Modelled	Actual	Comment	Reference
E	3	MET	-	initiating methionine	UNP P63043
E	4	ALA	-	expression tag	UNP P63043

- Molecule 4 is a protein called Tubulin-Tyrosine Ligase.

Mol	Chain	Residues	Atoms					ZeroOcc	AltConf	Trace
			Total	C	N	O	S			
4	F	352	Total	C	N	O	S	0	0	0
			2877	1843	495	525	14			

There are 6 discrepancies between the modelled and reference sequences:

Chain	Residue	Modelled	Actual	Comment	Reference
F	379	HIS	-	expression tag	UNP E1BQ43
F	380	HIS	-	expression tag	UNP E1BQ43
F	381	HIS	-	expression tag	UNP E1BQ43
F	382	HIS	-	expression tag	UNP E1BQ43
F	383	HIS	-	expression tag	UNP E1BQ43
F	384	HIS	-	expression tag	UNP E1BQ43

- Molecule 5 is GUANOSINE-5'-TRIPHOSPHATE (three-letter code: GTP) (formula:  $C_{10}H_{16}N_5O_{14}P_3$ ).

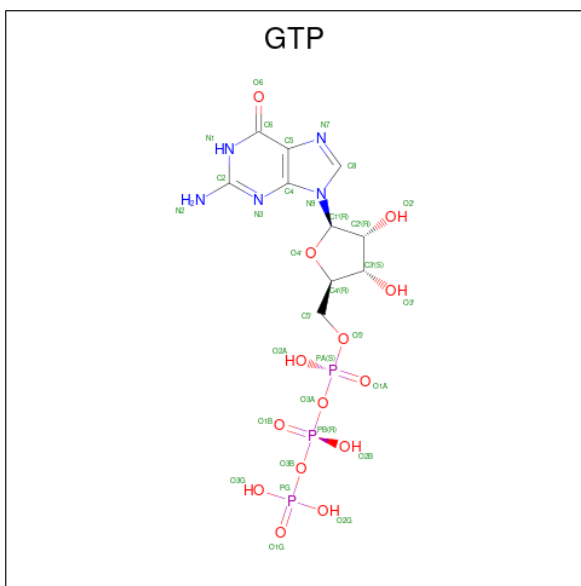

Mol	Chain	Residues	Atoms					ZeroOcc	AltConf
			Total	C	N	O	P		
5	A	1	Total	C	N	O	P	0	0
			32	10	5	14	3		
5	C	1	Total	C	N	O	P	0	0
			32	10	5	14	3		

- Molecule 6 is MAGNESIUM ION (three-letter code: MG) (formula: Mg).

Mol	Chain	Residues	Atoms		ZeroOcc	AltConf
			Total	Mg		
6	A	1	Total	Mg	0	0
			1	1		
6	B	1	Total	Mg	0	0
			1	1		
6	C	1	Total	Mg	0	0
			1	1		
6	D	1	Total	Mg	0	0
			1	1		

*Continued on next page...*

Continued from previous page...

Mol	Chain	Residues	Atoms		ZeroOcc	AltConf
6	F	1	Total	Mg	0	0
			1	1		

- Molecule 7 is CALCIUM ION (three-letter code: CA) (formula: Ca).

Mol	Chain	Residues	Atoms		ZeroOcc	AltConf
7	A	1	Total	Ca	0	0
			1	1		
7	B	1	Total	Ca	0	0
			1	1		
7	C	1	Total	Ca	0	0
			1	1		
7	E	1	Total	Ca	0	0
			1	1		

- Molecule 8 is GUANOSINE-5'-DIPHOSPHATE (three-letter code: GDP) (formula: C<sub>10</sub>H<sub>15</sub>N<sub>5</sub>O<sub>11</sub>P<sub>2</sub>).

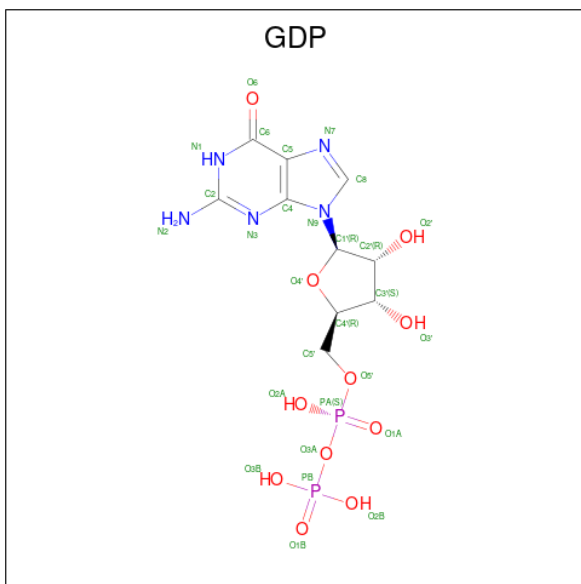

Mol	Chain	Residues	Atoms				ZeroOcc	AltConf	
8	B	1	Total	C	N	O	P	0	0
			28	10	5	11	2		
8	D	1	Total	C	N	O	P	0	0
			28	10	5	11	2		

- Molecule 9 is 2-(N-MORPHOLINO)-ETHANESULFONIC ACID (three-letter code: MES) (formula: C<sub>6</sub>H<sub>13</sub>NO<sub>4</sub>S).

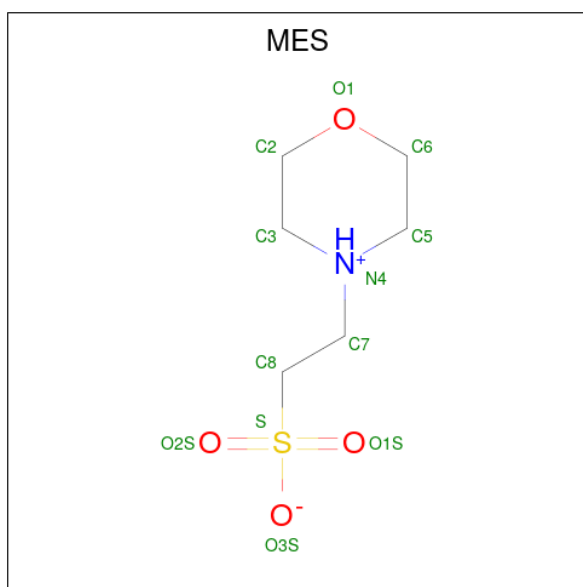

Mol	Chain	Residues	Atoms					ZeroOcc	AltConf
			Total	C	N	O	S		
9	B	1	12	6	1	4	1	0	0

- Molecule 10 is N-[4-(2-amino-1,3-thiazol-4-yl)phenyl]acetamide (three-letter code: O0J) (formula: C<sub>11</sub>H<sub>11</sub>N<sub>3</sub>OS) (labeled as "Ligand of Interest" by depositor).

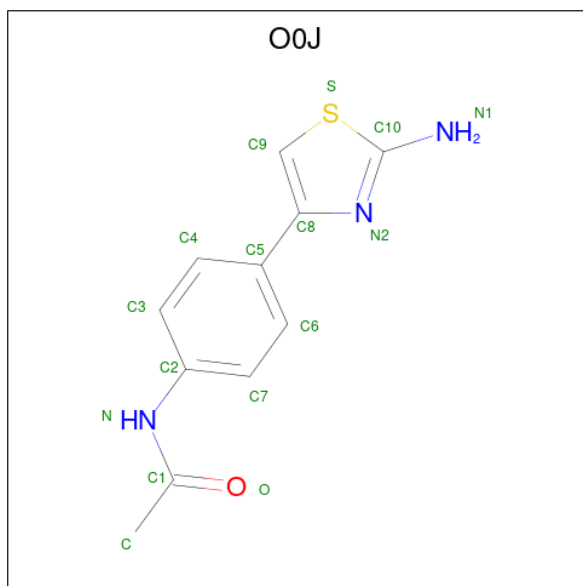

Mol	Chain	Residues	Atoms					ZeroOcc	AltConf	
			Total	C	H	N	O			S
10	C	1	27	11	11	3	1	1	0	0
10	D	1	27	11	11	3	1	1	0	0

- Molecule 11 is PHOSPHOMETHYLPHOSPHONIC ACID ADENYLATE ESTER (three-letter code: ACP) (formula:  $C_{11}H_{18}N_5O_{12}P_3$ ).

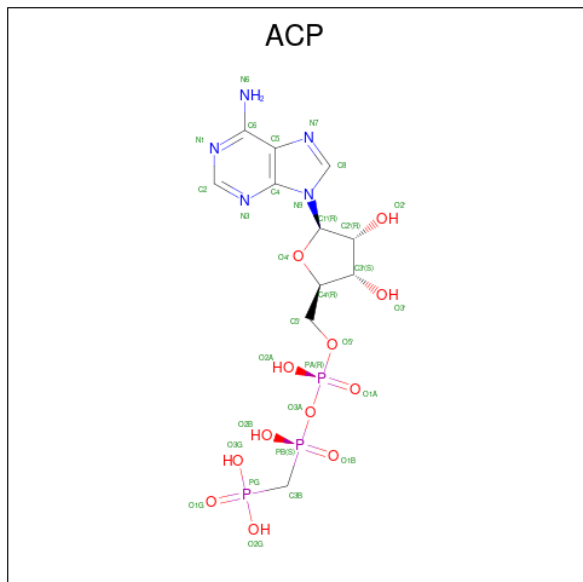

Mol	Chain	Residues	Atoms					ZeroOcc	AltConf
			Total	C	N	O	P		
11	F	1	31	11	5	12	3	0	0

- Molecule 12 is water.

Mol	Chain	Residues	Atoms		ZeroOcc	AltConf
12	A	83	Total	O	0	0
			83	83		
12	B	92	Total	O	0	0
			92	92		
12	C	204	Total	O	0	0
			204	204		
12	D	50	Total	O	0	0
			50	50		
12	E	13	Total	O	0	0
			13	13		
12	F	15	Total	O	0	0
			15	15		



### 3 Residue-property plots [i](#)

These plots are drawn for all protein, RNA, DNA and oligosaccharide chains in the entry. The first graphic for a chain summarises the proportions of the various outlier classes displayed in the second graphic. The second graphic shows the sequence view annotated by issues in geometry and electron density. Residues are color-coded according to the number of geometric quality criteria for which they contain at least one outlier: green = 0, yellow = 1, orange = 2 and red = 3 or more. A red dot above a residue indicates a poor fit to the electron density ( $RSRZ > 2$ ). Stretches of 2 or more consecutive residues without any outlier are shown as a green connector. Residues present in the sample, but not in the model, are shown in grey.

- Molecule 1: Tubulin alpha-1B chain

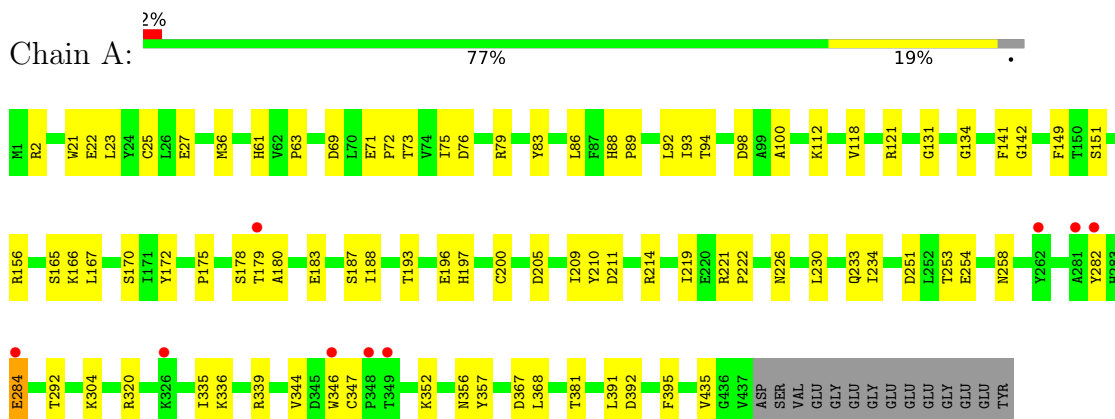

- Molecule 1: Tubulin alpha-1B chain

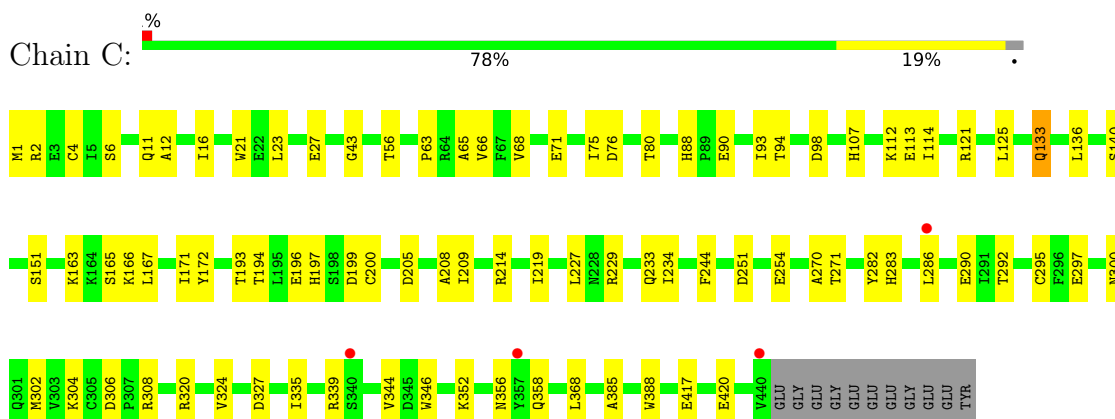

- Molecule 2: Tubulin beta-2B chain

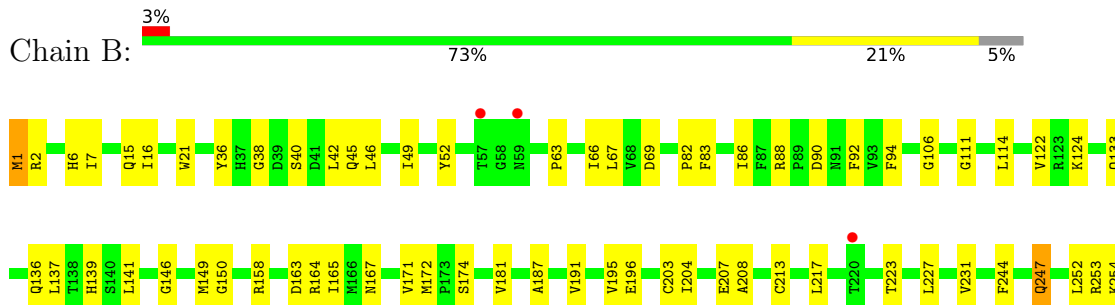

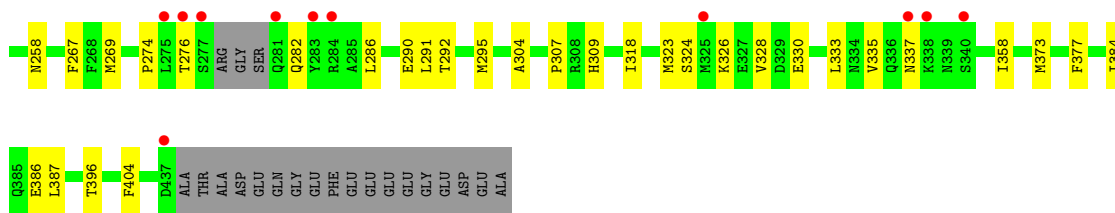

• Molecule 2: Tubulin beta-2B chain

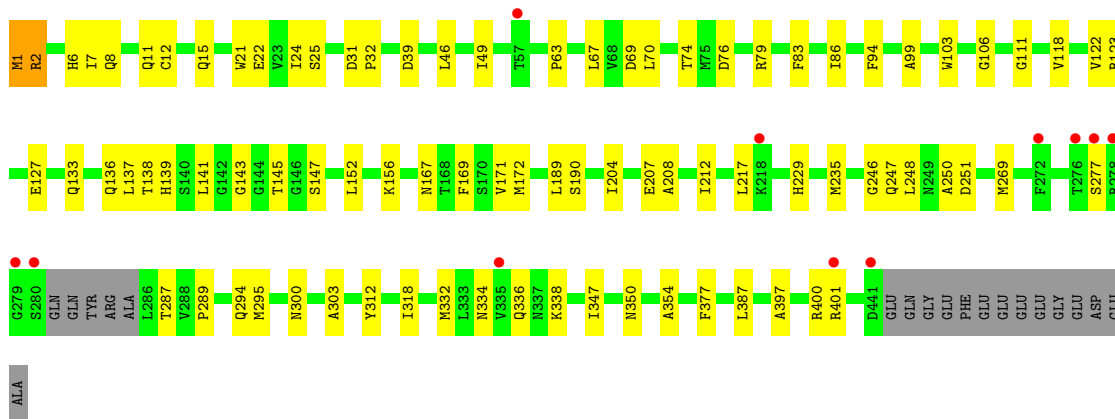
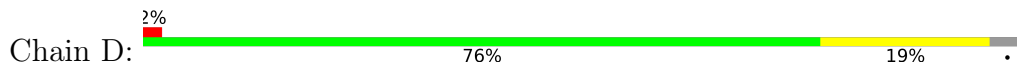

• Molecule 3: Stathmin-4

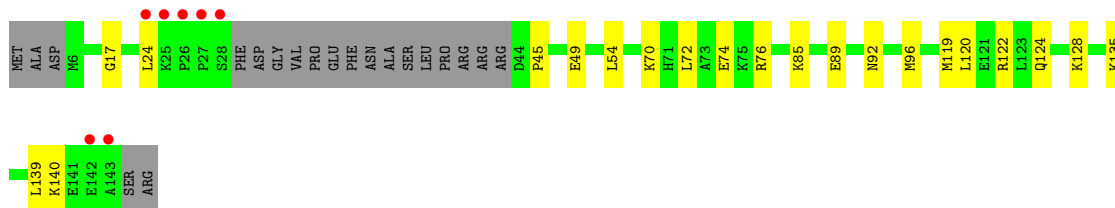

• Molecule 4: Tubulin-Tyrosine Ligase

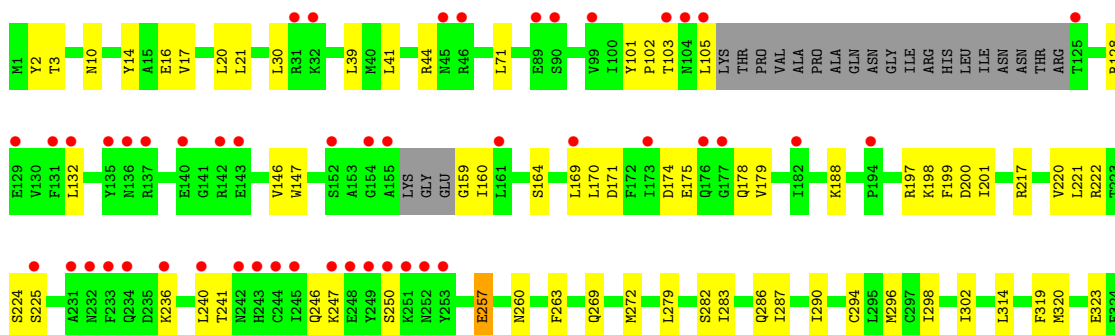

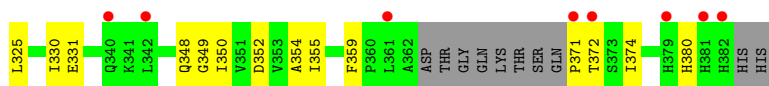

## 4 Data and refinement statistics

Property	Value	Source
Space group	P 21 21 21	Depositor
Cell constants a, b, c, $\alpha$ , $\beta$ , $\gamma$	104.74Å 158.00Å 178.59Å 90.00° 90.00° 90.00°	Depositor
Resolution (Å)	79.00 – 2.30 79.00 – 2.30	Depositor EDS
% Data completeness (in resolution range)	98.3 (79.00-2.30) 98.3 (79.00-2.30)	Depositor EDS
$R_{merge}$	0.13	Depositor
$R_{sym}$	(Not available)	Depositor
$\langle I/\sigma(I) \rangle$ <sup>1</sup>	2.16 (at 2.29Å)	Xtrriage
Refinement program	PHENIX 1.18.2_3874	Depositor
R, $R_{free}$	0.216 , 0.262 0.216 , 0.262	Depositor DCC
$R_{free}$ test set	1963 reflections (1.52%)	wwPDB-VP
Wilson B-factor (Å <sup>2</sup> )	39.0	Xtrriage
Anisotropy	0.222	Xtrriage
Bulk solvent $k_{sol}$ (e/Å <sup>3</sup> ), $B_{sol}$ (Å <sup>2</sup> )	0.32 , 39.8	EDS
L-test for twinning <sup>2</sup>	$\langle  L  \rangle = 0.50$ , $\langle L^2 \rangle = 0.33$	Xtrriage
Estimated twinning fraction	No twinning to report.	Xtrriage
$F_o, F_c$ correlation	0.94	EDS
Total number of atoms	18132	wwPDB-VP
Average B, all atoms (Å <sup>2</sup> )	45.0	wwPDB-VP

Xtrriage's analysis on translational NCS is as follows: *The largest off-origin peak in the Patterson function is 2.41% of the height of the origin peak. No significant pseudotranslation is detected.*

<sup>1</sup>Intensities estimated from amplitudes.

<sup>2</sup>Theoretical values of  $\langle |L| \rangle$ ,  $\langle L^2 \rangle$  for acentric reflections are 0.5, 0.333 respectively for untwinned datasets, and 0.375, 0.2 for perfectly twinned datasets.

## 5 Model quality [i](#)

### 5.1 Standard geometry [i](#)

Bond lengths and bond angles in the following residue types are not validated in this section: O0J, MES, GTP, ACP, CA, MG, GDP

The Z score for a bond length (or angle) is the number of standard deviations the observed value is removed from the expected value. A bond length (or angle) with  $|Z| > 5$  is considered an outlier worth inspection. RMSZ is the root-mean-square of all Z scores of the bond lengths (or angles).

Mol	Chain	Bond lengths		Bond angles	
		RMSZ	# Z  >5	RMSZ	# Z  >5
1	A	0.25	0/3494	0.42	0/4743
1	C	0.26	0/3529	0.42	0/4791
2	B	0.25	0/3422	0.41	0/4633
2	D	0.25	0/3416	0.41	0/4626
3	E	0.24	0/1022	0.34	0/1356
4	F	0.24	0/2944	0.39	0/3978
All	All	0.25	0/17827	0.41	0/24127

There are no bond length outliers.

There are no bond angle outliers.

There are no chirality outliers.

There are no planarity outliers.

### 5.2 Too-close contacts [i](#)

In the following table, the Non-H and H(model) columns list the number of non-hydrogen atoms and hydrogen atoms in the chain respectively. The H(added) column lists the number of hydrogen atoms added and optimized by MolProbity. The Clashes column lists the number of clashes within the asymmetric unit, whereas Symm-Clashes lists symmetry-related clashes.

Mol	Chain	Non-H	H(model)	H(added)	Clashes	Symm-Clashes
1	A	3416	0	3330	72	0
1	C	3451	0	3355	65	0
2	B	3348	0	3222	75	0
2	D	3343	0	3222	58	0
3	E	1014	0	1029	14	0
4	F	2877	0	2839	59	0
5	A	32	0	12	1	0

*Continued on next page...*

Continued from previous page...

Mol	Chain	Non-H	H(model)	H(added)	Clashes	Symm-Clashes
5	C	32	0	12	1	0
6	A	1	0	0	0	0
6	B	1	0	0	0	0
6	C	1	0	0	0	0
6	D	1	0	0	0	0
6	F	1	0	0	0	0
7	A	1	0	0	0	0
7	B	1	0	0	0	0
7	C	1	0	0	0	0
7	E	1	0	0	0	0
8	B	28	0	12	1	0
8	D	28	0	12	3	0
9	B	12	0	12	1	0
10	C	16	11	0	0	0
10	D	16	11	0	2	0
11	F	31	0	14	2	0
12	A	83	0	0	5	0
12	B	92	0	0	5	0
12	C	204	0	0	9	0
12	D	50	0	0	1	0
12	E	13	0	0	1	0
12	F	15	0	0	0	0
All	All	18110	22	17071	331	0

The all-atom clashscore is defined as the number of clashes found per 1000 atoms (including hydrogen atoms). The all-atom clashscore for this structure is 10.

All (331) close contacts within the same asymmetric unit are listed below, sorted by their clash magnitude.

Atom-1	Atom-2	Interatomic distance (Å)	Clash overlap (Å)
2:D:334:ASN:HD21	2:D:338:LYS:HE3	1.40	0.86
1:C:209:ILE:HD11	1:C:302:MET:HE3	1.59	0.84
1:A:211:ASP:OD2	1:A:304:LYS:NZ	2.13	0.80
4:F:10:ASN:HB2	4:F:44:ARG:HH22	1.45	0.79
2:B:163:ASP:OD1	12:B:601:HOH:O	1.98	0.79
2:D:1:MET:SD	2:D:1:MET:N	2.53	0.78
4:F:236:LYS:HB3	4:F:240:LEU:HD13	1.66	0.78
2:B:274:PRO:HB3	2:B:286:LEU:HD22	1.68	0.76
4:F:197:ARG:NH1	4:F:257:GLU:OE2	2.18	0.76
2:B:1:MET:SD	2:B:1:MET:N	2.55	0.75
1:A:71:GLU:OE2	1:A:73:THR:OG1	2.04	0.74

Continued on next page...

*Continued from previous page...*

Atom-1	Atom-2	Interatomic distance (Å)	Clash overlap (Å)
4:F:241:THR:OG1	11:F:401:ACP:O3'	1.98	0.73
4:F:331:GLU:OE2	11:F:401:ACP:O3G	2.08	0.72
2:D:172:MET:HG3	2:D:387:LEU:HD11	1.71	0.71
4:F:102:PRO:HG2	4:F:105:LEU:HD13	1.71	0.71
1:C:93:ILE:HD11	1:C:121:ARG:HG3	1.72	0.71
2:B:82:PRO:O	12:B:602:HOH:O	2.09	0.71
2:B:83:PHE:O	2:B:86:ILE:HG22	1.91	0.71
4:F:128:ARG:NH2	4:F:174:ASP:OD1	2.23	0.71
2:D:217:LEU:HA	2:D:277:SER:HB3	1.72	0.69
2:D:11:GLN:O	2:D:15:GLN:HG2	1.92	0.69
2:D:136:GLN:HA	2:D:167:ASN:O	1.91	0.69
1:C:420:GLU:OE1	12:C:601:HOH:O	2.09	0.68
2:D:152:LEU:O	2:D:156:LYS:HG2	1.93	0.68
1:C:2:ARG:NH1	1:C:251[A]:ASP:OD2	2.27	0.68
1:C:327:ASP:OD2	12:C:602:HOH:O	2.10	0.68
2:D:2:ARG:HB2	2:D:133:GLN:HE21	1.57	0.68
1:C:1:MET:O	12:C:603:HOH:O	2.12	0.67
1:C:76:ASP:O	1:C:80:THR:HG22	1.94	0.67
1:A:335:ILE:HG23	1:A:339:ARG:HG3	1.77	0.66
1:A:71:GLU:HG2	1:A:72:PRO:HD2	1.76	0.66
1:C:270:ALA:O	1:C:302:MET:HG2	1.94	0.66
1:C:320:ARG:HA	1:C:356:ASN:O	1.94	0.66
2:D:332:MET:O	2:D:336:GLN:HG3	1.96	0.66
1:A:98:ASP:H	2:B:2:ARG:NH2	1.95	0.65
2:B:69:ASP:O	2:B:94:PHE:HA	1.95	0.65
4:F:102:PRO:HG2	4:F:105:LEU:CD1	2.26	0.65
2:D:397:ALA:HA	2:D:400:ARG:NH1	2.12	0.65
1:C:21:TRP:CZ3	1:C:63:PRO:HB3	2.33	0.64
3:E:85:LYS:O	3:E:89:GLU:HG3	1.98	0.64
4:F:371:PRO:HA	4:F:372:THR:O	1.98	0.64
2:B:21:TRP:CZ3	2:B:63:PRO:HB3	2.33	0.64
1:C:209:ILE:HD11	1:C:302:MET:CE	2.27	0.64
1:A:88:HIS:HB2	1:A:89:PRO:HD2	1.81	0.63
2:D:334:ASN:ND2	2:D:338:LYS:HE3	2.11	0.63
2:D:83:PHE:O	2:D:86:ILE:HG22	1.99	0.63
4:F:132:LEU:HD21	4:F:170:LEU:HD11	1.81	0.63
2:B:295:MET:CG	2:B:377:PHE:HB2	2.29	0.62
1:A:336:LYS:HG3	3:E:24:LEU:HD13	1.81	0.62
1:A:93:ILE:HD11	1:A:121:ARG:HG3	1.81	0.62
2:B:269:MET:HG2	2:B:384:ILE:HD13	1.82	0.62
2:D:69:ASP:O	2:D:94:PHE:HA	2.00	0.62

*Continued on next page...*

*Continued from previous page...*

Atom-1	Atom-2	Interatomic distance (Å)	Clash overlap (Å)
2:B:208:ALA:HB2	2:B:304:ALA:HB2	1.82	0.61
1:A:98:ASP:HB2	5:A:501:GTP:O2G	1.99	0.61
4:F:178:GLN:N	4:F:178:GLN:OE1	2.33	0.61
1:A:187:SER:HB3	1:A:391:LEU:HD21	1.82	0.61
2:B:286:LEU:HD12	2:B:290:GLU:OE1	2.00	0.61
1:A:23:LEU:O	1:A:27:GLU:HG3	2.00	0.61
1:A:36:MET:HB3	1:A:61:HIS:CE1	2.36	0.61
2:D:21:TRP:CZ3	2:D:63:PRO:HB3	2.35	0.61
1:C:244:PHE:CD1	1:C:358:GLN:HG3	2.36	0.60
1:A:166:LYS:HE2	1:A:197:HIS:O	2.02	0.60
1:A:254:GLU:HG2	1:A:258:ASN:ND2	2.17	0.60
1:A:210:TYR:CE1	1:A:222:PRO:HD2	2.37	0.60
1:C:11:GLN:HE22	2:D:247:GLN:HE22	1.48	0.59
4:F:371:PRO:HA	4:F:372:THR:C	2.22	0.59
1:C:4[A]:CYS:SG	1:C:136:LEU:HG	2.42	0.59
1:C:306:ASP:OD1	1:C:308:ARG:HG2	2.03	0.59
1:C:251[B]:ASP:OD1	12:C:604:HOH:O	2.17	0.59
1:C:335:ILE:HG23	1:C:339:ARG:HG3	1.83	0.59
2:B:326:LYS:O	2:B:330:GLU:HG3	2.02	0.59
1:A:187:SER:CB	1:A:391:LEU:HD21	2.33	0.58
2:B:141:LEU:HD12	2:B:172:MET:SD	2.42	0.58
2:B:88:ARG:HH11	2:B:90:ASP:HB2	1.69	0.58
4:F:147:TRP:HB2	4:F:169:LEU:HD11	1.86	0.58
2:B:136:GLN:HA	2:B:167:ASN:O	2.02	0.58
2:B:36:TYR:CD1	2:B:46:LEU:HD21	2.39	0.58
2:D:171:VAL:HA	2:D:204:ILE:O	2.04	0.57
2:B:106:GLY:O	2:B:111:GLY:HA3	2.04	0.57
1:C:165:SER:HA	1:C:199:ASP:OD2	2.04	0.57
2:B:16:ILE:HD13	2:B:231:VAL:HG11	1.87	0.57
4:F:246:GLN:O	4:F:250:SER:HB3	2.03	0.57
1:C:196:GLU:HG2	12:C:630:HOH:O	2.04	0.57
2:B:164:ARG:HD2	12:B:642:HOH:O	2.05	0.57
2:B:274:PRO:HB3	2:B:286:LEU:CD2	2.34	0.57
1:A:75:ILE:HD12	1:A:94:THR:HG22	1.87	0.57
2:B:295:MET:HG3	2:B:377:PHE:HB2	1.87	0.56
2:D:147:SER:HB2	2:D:190:SER:OG	2.05	0.56
1:A:21:TRP:CZ3	1:A:63:PRO:HB3	2.41	0.56
1:C:11:GLN:HE22	2:D:247:GLN:NE2	2.04	0.56
4:F:348:GLN:NE2	4:F:352:ASP:OD1	2.38	0.56
2:D:103:TRP:CE3	2:D:189:LEU:HD13	2.41	0.55
3:E:92:ASN:O	3:E:96:MET:HG2	2.07	0.55

*Continued on next page...*



*Continued from previous page...*

Atom-1	Atom-2	Interatomic distance (Å)	Clash overlap (Å)
4:F:349:GLY:HA3	4:F:374:ILE:HD11	1.87	0.55
4:F:371:PRO:CA	4:F:372:THR:HB	2.36	0.55
1:A:156:ARG:NE	12:A:601:HOH:O	2.20	0.55
2:D:12:CYS:HB2	8:D:501:GDP:C8	2.41	0.55
2:B:253[A]:ARG:NH1	9:B:504:MES:O3S	2.39	0.55
4:F:246:GLN:HB3	4:F:260:ASN:ND2	2.21	0.55
2:B:333:LEU:O	2:B:337:ASN:ND2	2.39	0.55
2:D:143:GLY:HA3	8:D:501:GDP:O3A	2.07	0.54
1:C:214:ARG:HG2	1:C:219:ILE:O	2.07	0.54
2:B:88:ARG:NH1	2:B:90:ASP:HB2	2.22	0.54
2:B:223:THR:O	2:B:227:LEU:HD13	2.08	0.54
2:B:323:MET:HB3	2:B:373:MET:CE	2.38	0.54
2:D:106:GLY:O	2:D:111:GLY:HA3	2.07	0.54
1:A:180:ALA:HB3	1:A:183:GLU:HG3	1.90	0.54
1:C:172:TYR:HB3	1:C:205:ASP:HA	1.90	0.53
1:C:271:THR:HG21	1:C:295:CYS:O	2.07	0.53
4:F:171:ASP:O	4:F:175:GLU:HG3	2.08	0.53
1:C:16:ILE:CD1	1:C:171:ILE:HD11	2.38	0.53
2:D:70:LEU:HD12	2:D:99:ALA:HB2	1.91	0.53
2:D:246:GLY:HA3	12:D:619:HOH:O	2.09	0.53
3:E:85:LYS:NZ	12:E:303:HOH:O	2.42	0.53
3:E:45:PRO:HA	3:E:49:GLU:OE1	2.07	0.53
3:E:120:LEU:O	3:E:124:GLN:HG3	2.09	0.53
2:D:6:HIS:CD2	2:D:21:TRP:HE1	2.26	0.53
2:D:76:ASP:HA	2:D:79:ARG:NH1	2.24	0.53
1:A:251:ASP:OD1	1:A:253:THR:HB	2.08	0.52
2:B:276:THR:HG21	2:B:282:GLN:HA	1.92	0.52
1:A:112:LYS:HD2	3:E:54:LEU:HB3	1.90	0.52
1:A:292:THR:HG22	1:A:335:ILE:HD12	1.90	0.52
1:C:112:LYS:NZ	1:C:113:GLU:OE2	2.43	0.52
2:D:21:TRP:CE3	2:D:63:PRO:HB3	2.45	0.52
1:A:75:ILE:HB	1:A:94:THR:CG2	2.40	0.51
1:C:209:ILE:HG22	1:C:227:LEU:HD22	1.92	0.51
2:B:6:HIS:CD2	2:B:21:TRP:HE1	2.28	0.51
2:D:287:THR:HB	2:D:289:PRO:HD2	1.92	0.51
1:A:71:GLU:HG2	1:A:72:PRO:CD	2.41	0.51
1:C:151:SER:HB2	1:C:193:THR:CG2	2.40	0.51
1:C:292:THR:HG22	1:C:335:ILE:CD1	2.40	0.51
1:A:98:ASP:CG	2:B:2:ARG:HH22	2.14	0.51
2:B:67:LEU:HD22	2:B:92:PHE:CE2	2.46	0.51
2:B:292:THR:HG22	2:B:335:VAL:HG21	1.92	0.51

*Continued on next page...*

*Continued from previous page...*

Atom-1	Atom-2	Interatomic distance (Å)	Clash overlap (Å)
1:C:21:TRP:CE3	1:C:63:PRO:HB3	2.45	0.51
2:B:66:ILE:HD12	2:B:122:VAL:HG22	1.93	0.51
2:B:324:SER:O	2:B:328:VAL:HG23	2.11	0.51
1:C:167:LEU:HG	1:C:200:CYS:HB3	1.92	0.51
1:C:251[B]:ASP:OD1	1:C:251[B]:ASP:N	2.39	0.51
2:D:31:ASP:HB2	2:D:32:PRO:CD	2.40	0.51
2:B:21:TRP:CE3	2:B:63:PRO:HB3	2.46	0.51
1:C:344:VAL:HG21	1:C:346:TRP:CE2	2.45	0.51
2:D:76:ASP:HA	2:D:79:ARG:HH12	1.75	0.51
1:A:356:ASN:HB2	12:A:603:HOH:O	2.11	0.51
1:C:324:VAL:HG22	12:C:602:HOH:O	2.11	0.50
4:F:17:VAL:O	4:F:21:LEU:HG	2.11	0.50
1:C:229:ARG:HG3	12:C:620:HOH:O	2.10	0.50
2:B:42:LEU:H	2:B:42:LEU:HD12	1.76	0.50
2:D:208:ALA:O	2:D:212:ILE:HG13	2.11	0.50
4:F:320:MET:HG3	4:F:330:ILE:HD11	1.92	0.50
4:F:197:ARG:HB2	4:F:224:SER:O	2.11	0.50
1:A:292:THR:HG22	1:A:335:ILE:CD1	2.42	0.50
2:B:2:ARG:HB3	2:B:133:GLN:CG	2.41	0.50
1:C:66:VAL:HG12	1:C:68:VAL:HG23	1.94	0.50
2:D:248:LEU:HD23	2:D:354:ALA:HB2	1.93	0.50
4:F:269:GLN:HA	4:F:272:MET:HE2	1.92	0.50
1:A:233:GLN:HG3	1:A:368:LEU:CD1	2.41	0.50
2:B:15:GLN:NE2	8:B:501:GDP:O6	2.44	0.50
2:B:38:GLY:HA3	2:B:45:GLN:OE1	2.12	0.50
2:D:269:MET:HG3	2:D:303:ALA:HB3	1.94	0.50
4:F:279:LEU:HD12	4:F:283:ILE:HB	1.94	0.50
2:B:165:ILE:HG21	2:B:252:LEU:HB3	1.94	0.49
2:B:323:MET:HE2	2:B:373:MET:HB2	1.94	0.49
1:C:286:LEU:HA	1:C:290:GLU:OE1	2.12	0.49
3:E:128:LYS:O	3:E:128:LYS:HD3	2.11	0.49
1:A:142:GLY:HA3	1:A:183:GLU:OE2	2.11	0.49
1:A:167:LEU:HG	1:A:200:CYS:HB3	1.94	0.49
4:F:200:ASP:OD1	4:F:222:ARG:HB2	2.13	0.49
4:F:217:ARG:NH2	4:F:374:ILE:HA	2.27	0.49
4:F:222:ARG:O	4:F:241:THR:HB	2.12	0.49
2:B:172:MET:HG3	2:B:387:LEU:HD11	1.95	0.49
2:D:251:ASP:HB3	10:D:503:OOJ:N1	2.27	0.49
1:A:69:ASP:O	1:A:94:THR:HA	2.13	0.48
2:D:31:ASP:HB2	2:D:32:PRO:HD2	1.96	0.48
4:F:220:VAL:HG12	4:F:263:PHE:CE1	2.49	0.48

*Continued on next page...*

*Continued from previous page...*

Atom-1	Atom-2	Interatomic distance (Å)	Clash overlap (Å)
1:A:196:GLU:OE1	1:A:196:GLU:HA	2.13	0.48
1:A:320:ARG:HD2	12:A:666:HOH:O	2.13	0.48
2:B:124:LYS:HD3	2:B:124:LYS:C	2.34	0.48
1:C:23:LEU:O	1:C:27:GLU:HG3	2.13	0.48
1:C:233:GLN:HG3	1:C:368:LEU:CD1	2.44	0.48
2:D:67:LEU:N	2:D:67:LEU:HD12	2.28	0.48
2:D:347:ILE:HG22	2:D:350:ASN:HB3	1.95	0.48
4:F:3:THR:HB	4:F:30:LEU:HD11	1.95	0.48
4:F:246:GLN:HB3	4:F:260:ASN:HD22	1.79	0.48
4:F:371:PRO:N	4:F:372:THR:HB	2.29	0.48
2:B:46:LEU:HA	2:B:49:ILE:HB	1.96	0.48
4:F:198:LYS:HG2	4:F:199:PHE:H	1.79	0.48
1:A:209:ILE:HG23	1:A:230:LEU:HD23	1.95	0.47
4:F:2:TYR:CE1	4:F:359:PHE:HB3	2.49	0.47
1:A:335:ILE:HG23	1:A:339:ARG:CG	2.42	0.47
2:B:323:MET:HB3	2:B:373:MET:HE2	1.96	0.47
4:F:160:ILE:HD12	4:F:160:ILE:N	2.29	0.47
1:A:83:TYR:HB3	1:A:86:LEU:HD12	1.97	0.47
2:B:318:ILE:N	2:B:318:ILE:HD12	2.29	0.47
4:F:296:MET:SD	4:F:380:HIS:HB2	2.53	0.47
4:F:371:PRO:HA	4:F:372:THR:HB	1.97	0.47
1:A:233:GLN:HG3	1:A:368:LEU:HD12	1.96	0.47
2:D:46:LEU:HA	2:D:49:ILE:HB	1.97	0.47
1:A:188:ILE:HD11	1:A:392:ASP:HA	1.96	0.47
1:A:230:LEU:O	1:A:234:ILE:HD13	2.14	0.47
1:C:93:ILE:HG22	1:C:114:ILE:HD11	1.96	0.47
2:D:295:MET:HB2	2:D:295:MET:HE3	1.82	0.47
2:B:208:ALA:HB2	2:B:304:ALA:N	2.30	0.47
2:B:286:LEU:HD23	2:B:291:LEU:HD23	1.97	0.47
4:F:14:TYR:HB3	4:F:41:LEU:HD13	1.96	0.47
1:C:88:HIS:HE1	1:C:90:GLU:HG3	1.79	0.47
2:D:169:PHE:CE2	2:D:235:MET:HG2	2.50	0.47
2:D:387:LEU:HD23	2:D:387:LEU:C	2.35	0.47
2:D:294:GLN:HG2	2:D:300:ASN:ND2	2.30	0.46
2:D:318:ILE:N	2:D:318:ILE:HD12	2.29	0.46
1:A:234:ILE:HD12	1:A:234:ILE:N	2.31	0.46
1:C:254:GLU:HG2	1:C:352:LYS:HE2	1.96	0.46
1:A:79:ARG:HG2	1:A:92:LEU:HD12	1.97	0.46
2:B:187:ALA:O	2:B:191:VAL:HG23	2.15	0.46
2:D:118:VAL:O	2:D:122:VAL:HG23	2.16	0.46
1:A:258:ASN:OD1	1:A:352:LYS:HE2	2.16	0.46

*Continued on next page...*

*Continued from previous page...*

Atom-1	Atom-2	Interatomic distance (Å)	Clash overlap (Å)
1:A:356:ASN:ND2	12:A:603:HOH:O	2.39	0.46
2:B:286:LEU:HD23	2:B:291:LEU:CD2	2.46	0.46
4:F:287:ILE:HG23	4:F:319:PHE:CE2	2.51	0.45
4:F:298:ILE:HD12	4:F:302:ILE:HD13	1.98	0.45
2:D:123:ARG:O	2:D:127:GLU:HG3	2.16	0.45
4:F:236:LYS:HB3	4:F:240:LEU:CD1	2.43	0.45
2:B:269:MET:HE1	2:B:307:PRO:HG3	1.98	0.45
2:D:145:THR:HB	8:D:501:GDP:O2B	2.16	0.45
3:E:70:LYS:O	3:E:74:GLU:HG3	2.16	0.45
1:A:2:ARG:HB3	1:A:131:GLY:O	2.16	0.45
1:A:21:TRP:CE3	1:A:63:PRO:HB3	2.52	0.45
1:C:93:ILE:CD1	1:C:121:ARG:HG3	2.45	0.45
1:C:229:ARG:NH1	12:C:620:HOH:O	2.50	0.45
2:D:22:GLU:HG2	2:D:83:PHE:CD1	2.52	0.45
1:C:75:ILE:HB	1:C:94:THR:CG2	2.46	0.45
2:D:250:ALA:O	10:D:503:O0J:N1	2.49	0.45
2:B:40:SER:OG	2:B:42:LEU:HD13	2.17	0.45
1:A:226:ASN:ND2	1:A:367:ASP:OD2	2.49	0.44
2:D:169:PHE:CD2	2:D:235:MET:HG2	2.52	0.44
4:F:147:TRP:HB2	4:F:169:LEU:CD1	2.46	0.44
1:A:100:ALA:CB	2:B:253[B]:ARG:HG2	2.47	0.44
1:A:210:TYR:CZ	1:A:222:PRO:HD2	2.53	0.44
1:C:2:ARG:HA	1:C:133:GLN:HG3	1.99	0.44
3:E:72:LEU:O	3:E:76:ARG:HG2	2.17	0.44
4:F:16:GLU:O	4:F:20:LEU:HG	2.17	0.44
1:C:208:ALA:HB2	1:C:304:LYS:HG3	1.99	0.44
4:F:269:GLN:HA	4:F:272:MET:CE	2.47	0.44
1:A:141:PHE:CE1	1:A:170:SER:HB3	2.53	0.44
1:A:180:ALA:HA	2:B:258:ASN:OD1	2.18	0.44
1:C:21:TRP:CH2	1:C:63:PRO:HB3	2.52	0.44
4:F:240:LEU:HD12	4:F:240:LEU:N	2.33	0.44
2:B:309:HIS:ND1	2:B:386:GLU:OE2	2.33	0.44
1:A:118:VAL:HG21	1:A:149:PHE:CZ	2.53	0.44
1:A:214:ARG:HG2	1:A:219:ILE:O	2.18	0.44
1:C:297:GLU:HB3	1:C:300:ASN:HD22	1.82	0.44
1:A:100:ALA:HA	2:B:254:LYS:HG3	2.00	0.44
1:C:66:VAL:HG23	1:C:125:LEU:CD1	2.48	0.44
4:F:314:LEU:HD22	4:F:350:ILE:HD11	2.00	0.44
1:A:100:ALA:HB1	2:B:253[B]:ARG:HG2	1.99	0.43
4:F:103:THR:HG23	4:F:128:ARG:NH2	2.33	0.43
4:F:146:VAL:HG22	4:F:164:SER:HB3	2.00	0.43

*Continued on next page...*

*Continued from previous page...*

Atom-1	Atom-2	Interatomic distance (Å)	Clash overlap (Å)
4:F:159:GLY:C	4:F:160:ILE:HD12	2.38	0.43
12:B:629:HOH:O	1:C:163:LYS:HD2	2.18	0.43
2:D:312:TYR:CE1	2:D:377:PHE:HZ	2.36	0.43
2:B:171:VAL:HA	2:B:204:ILE:O	2.18	0.43
2:B:213:CYS:HA	2:B:217:LEU:HB2	2.00	0.43
1:A:193:THR:HG23	12:A:657:HOH:O	2.19	0.43
2:B:42:LEU:HD12	2:B:42:LEU:N	2.32	0.43
2:B:158:ARG:NH1	2:B:196:GLU:O	2.52	0.43
1:C:151:SER:HB2	1:C:193:THR:HG21	2.00	0.43
1:A:344:VAL:HG23	1:A:347:CYS:HB2	2.01	0.43
2:B:67:LEU:N	2:B:67:LEU:HD12	2.34	0.43
4:F:188:LYS:HD3	4:F:323:GLU:OE2	2.17	0.43
1:A:284:GLU:CD	1:A:284:GLU:H	2.22	0.43
1:A:179:THR:HG21	2:B:247:GLN:HB3	2.00	0.43
1:C:107:HIS:HD2	1:C:151:SER:OG	2.01	0.43
1:C:385:ALA:HA	1:C:388:TRP:CD1	2.54	0.43
1:C:6:SER:O	1:C:65:ALA:HA	2.19	0.42
1:C:98:ASP:HB2	5:C:501:GTP:O2G	2.19	0.42
4:F:350:ILE:O	4:F:354:ALA:HB3	2.18	0.42
2:B:7:ILE:O	2:B:137:LEU:HA	2.19	0.42
4:F:225:SER:HG	4:F:250:SER:HG	1.67	0.42
2:B:174:SER:HB2	2:B:207:GLU:HB2	2.01	0.42
1:C:88:HIS:CE1	1:C:90:GLU:HG3	2.55	0.42
1:A:134:GLY:HA3	1:A:165:SER:O	2.19	0.42
1:A:188:ILE:HD12	1:A:395:PHE:HB2	2.00	0.42
4:F:101:TYR:CD2	4:F:179:VAL:HG22	2.54	0.42
1:A:76:ASP:OD1	1:A:79:ARG:NH1	2.50	0.42
1:A:151:SER:HB2	1:A:193:THR:OG1	2.20	0.42
1:A:172:TYR:HB3	1:A:205:ASP:HA	2.02	0.42
1:A:175:PRO:HA	1:A:178:SER:HB3	2.02	0.42
1:A:346:TRP:HZ2	1:A:435:VAL:HG13	1.84	0.42
2:B:146:GLY:O	2:B:150:GLY:HA3	2.19	0.42
2:B:295:MET:HG2	2:B:377:PHE:HB2	2.01	0.42
3:E:140:LYS:HE2	3:E:140:LYS:HB3	1.83	0.42
2:D:2:ARG:HB2	2:D:133:GLN:NE2	2.31	0.41
2:B:114:LEU:HD23	2:B:149:MET:HE1	2.02	0.41
1:C:75:ILE:HB	1:C:94:THR:HG21	2.03	0.41
2:D:15:GLN:NE2	2:D:74:THR:HG23	2.35	0.41
1:C:12:ALA:HB3	1:C:140:SER:HB3	2.02	0.41
1:C:234:ILE:HG12	1:C:302:MET:HE2	2.01	0.41
4:F:201:ILE:HG12	4:F:221:LEU:HG	2.01	0.41

*Continued on next page...*

*Continued from previous page...*

Atom-1	Atom-2	Interatomic distance (Å)	Clash overlap (Å)
1:A:357:TYR:CE2	3:E:17:GLY:HA2	2.54	0.41
3:E:119:MET:HA	3:E:122:ARG:NH2	2.35	0.41
3:E:135:LYS:NZ	3:E:139:LEU:HD11	2.35	0.41
4:F:71:LEU:HD11	4:F:294:CYS:HB3	2.02	0.41
2:B:396:THR:HG23	12:B:668:HOH:O	2.20	0.41
1:C:166:LYS:HE2	1:C:197:HIS:O	2.20	0.41
2:D:7:ILE:O	2:D:137:LEU:HA	2.20	0.41
2:D:141:LEU:HA	2:D:147:SER:HB3	2.03	0.41
4:F:39:LEU:CD2	4:F:355:ILE:HD13	2.50	0.41
4:F:247:LYS:HG2	4:F:247:LYS:O	2.20	0.41
1:A:320:ARG:HA	1:A:356:ASN:O	2.21	0.41
2:B:21:TRP:CH2	2:B:52:TYR:HB3	2.56	0.41
2:B:203:CYS:SG	2:B:267:PHE:HB3	2.61	0.41
2:D:24:ILE:HG13	2:D:25:SER:N	2.35	0.41
4:F:282:SER:HB2	4:F:325:LEU:HD13	2.02	0.41
1:A:22:GLU:HG3	1:A:83:TYR:HE2	1.85	0.41
2:B:191:VAL:O	2:B:195:VAL:HG23	2.21	0.41
1:C:43:GLY:HA2	1:C:56:THR:O	2.21	0.41
1:A:344:VAL:CG2	1:A:347:CYS:HB2	2.50	0.40
2:B:244:PHE:CE1	2:B:358:ILE:HD12	2.56	0.40
1:C:194:THR:O	1:C:194:THR:HG22	2.21	0.40
1:C:282:TYR:O	1:C:283:HIS:HB2	2.22	0.40
1:A:25:CYS:SG	1:A:86:LEU:HD11	2.61	0.40
2:B:181:VAL:HG21	2:B:404:PHE:CZ	2.57	0.40
2:B:2:ARG:HB3	2:B:133:GLN:HG2	2.03	0.40
2:D:8:GLN:HB3	2:D:138:THR:OG1	2.21	0.40
4:F:286:GLN:O	4:F:290:ILE:HG13	2.21	0.40
1:A:75:ILE:HB	1:A:94:THR:HG21	2.02	0.40
1:C:292:THR:HG22	1:C:335:ILE:HD12	2.04	0.40
2:D:287:THR:CB	2:D:289:PRO:HD2	2.51	0.40
1:C:417:GLU:OE2	12:C:605:HOH:O	2.22	0.40
2:D:397:ALA:O	2:D:401:ARG:NH1	2.55	0.40
4:F:128:ARG:NH1	4:F:170:LEU:HD22	2.36	0.40

There are no symmetry-related clashes.

## 5.3 Torsion angles [i](#)

### 5.3.1 Protein backbone [i](#)

In the following table, the Percentiles column shows the percent Ramachandran outliers of the chain as a percentile score with respect to all X-ray entries followed by that with respect to entries of similar resolution.

The Analysed column shows the number of residues for which the backbone conformation was analysed, and the total number of residues.

Mol	Chain	Analysed	Favoured	Allowed	Outliers	Percentiles	
1	A	435/451 (96%)	424 (98%)	11 (2%)	0	100	100
1	C	440/451 (98%)	430 (98%)	10 (2%)	0	100	100
2	B	421/445 (95%)	412 (98%)	9 (2%)	0	100	100
2	D	422/445 (95%)	409 (97%)	13 (3%)	0	100	100
3	E	119/143 (83%)	118 (99%)	1 (1%)	0	100	100
4	F	344/384 (90%)	325 (94%)	19 (6%)	0	100	100
All	All	2181/2319 (94%)	2118 (97%)	63 (3%)	0	100	100

There are no Ramachandran outliers to report.

### 5.3.2 Protein sidechains [i](#)

In the following table, the Percentiles column shows the percent sidechain outliers of the chain as a percentile score with respect to all X-ray entries followed by that with respect to entries of similar resolution.

The Analysed column shows the number of residues for which the sidechain conformation was analysed, and the total number of residues.

Mol	Chain	Analysed	Rotameric	Outliers	Percentiles	
1	A	368/379 (97%)	364 (99%)	4 (1%)	73	86
1	C	373/379 (98%)	371 (100%)	2 (0%)	88	95
2	B	367/383 (96%)	364 (99%)	3 (1%)	81	91
2	D	368/383 (96%)	362 (98%)	6 (2%)	62	78
3	E	110/127 (87%)	110 (100%)	0	100	100
4	F	315/342 (92%)	314 (100%)	1 (0%)	92	97
All	All	1901/1993 (95%)	1885 (99%)	16 (1%)	81	91

All (16) residues with a non-rotameric sidechain are listed below:

Mol	Chain	Res	Type
1	A	221	ARG
1	A	282	TYR
1	A	284	GLU
1	A	381	THR
2	B	1	MET
2	B	139	HIS
2	B	247	GLN
1	C	71	GLU
1	C	133	GLN
2	D	1	MET
2	D	2	ARG
2	D	39	ASP
2	D	139	HIS
2	D	207	GLU
2	D	229	HIS
4	F	257	GLU

Sometimes sidechains can be flipped to improve hydrogen bonding and reduce clashes. All (14) such sidechains are listed below:

Mol	Chain	Res	Type
1	A	88	HIS
1	A	300	ASN
1	A	301	GLN
2	B	247	GLN
2	B	282	GLN
2	B	294	GLN
1	C	406	HIS
2	D	247	GLN
4	F	180	HIS
4	F	229	ASN
4	F	269	GLN
4	F	333	ASN
4	F	348	GLN
4	F	380	HIS

### 5.3.3 RNA [i](#)

There are no RNA molecules in this entry.



## 5.4 Non-standard residues in protein, DNA, RNA chains [i](#)

There are no non-standard protein/DNA/RNA residues in this entry.

## 5.5 Carbohydrates [i](#)

There are no monosaccharides in this entry.

## 5.6 Ligand geometry [i](#)

Of 17 ligands modelled in this entry, 9 are monoatomic - leaving 8 for Mogul analysis.

In the following table, the Counts columns list the number of bonds (or angles) for which Mogul statistics could be retrieved, the number of bonds (or angles) that are observed in the model and the number of bonds (or angles) that are defined in the Chemical Component Dictionary. The Link column lists molecule types, if any, to which the group is linked. The Z score for a bond length (or angle) is the number of standard deviations the observed value is removed from the expected value. A bond length (or angle) with  $|Z| > 2$  is considered an outlier worth inspection. RMSZ is the root-mean-square of all Z scores of the bond lengths (or angles).

Mol	Type	Chain	Res	Link	Bond lengths			Bond angles		
					Counts	RMSZ	# Z  > 2	Counts	RMSZ	# Z  > 2
5	GTP	A	501	6	26,34,34	1.15	1 (3%)	32,54,54	1.30	5 (15%)
9	MES	B	504	-	12,12,12	2.26	1 (8%)	14,16,16	1.99	5 (35%)
11	ACP	F	401	6	27,33,33	1.39	5 (18%)	32,52,52	1.50	4 (12%)
10	O0J	D	503	-	14,17,17	1.47	2 (14%)	18,23,23	0.81	1 (5%)
5	GTP	C	501	6	26,34,34	1.15	2 (7%)	32,54,54	1.34	6 (18%)
8	GDP	B	501	6	24,30,30	0.92	1 (4%)	30,47,47	1.08	3 (10%)
8	GDP	D	501	6	24,30,30	0.93	1 (4%)	30,47,47	1.09	3 (10%)
10	O0J	C	504	-	14,17,17	1.49	2 (14%)	18,23,23	0.75	0

In the following table, the Chirals column lists the number of chiral outliers, the number of chiral centers analysed, the number of these observed in the model and the number defined in the Chemical Component Dictionary. Similar counts are reported in the Torsion and Rings columns. '-' means no outliers of that kind were identified.

Mol	Type	Chain	Res	Link	Chirals	Torsions	Rings
5	GTP	A	501	6	-	8/18/38/38	0/3/3/3
9	MES	B	504	-	-	4/6/14/14	0/1/1/1
11	ACP	F	401	6	-	10/15/38/38	0/3/3/3
10	O0J	D	503	-	-	0/8/8/8	0/2/2/2

*Continued on next page...*

Continued from previous page...

Mol	Type	Chain	Res	Link	Chirals	Torsions	Rings
5	GTP	C	501	6	-	9/18/38/38	0/3/3/3
8	GDP	B	501	6	-	3/12/32/32	0/3/3/3
8	GDP	D	501	6	-	6/12/32/32	0/3/3/3
10	O0J	C	504	-	-	0/8/8/8	0/2/2/2

All (15) bond length outliers are listed below:

Mol	Chain	Res	Type	Atoms	Z	Observed(Å)	Ideal(Å)
9	B	504	MES	C8-S	-7.56	1.66	1.77
5	A	501	GTP	C5-C6	-4.09	1.39	1.47
5	C	501	GTP	C5-C6	-3.95	1.39	1.47
10	C	504	O0J	C1-N	3.26	1.42	1.36
10	D	503	O0J	C1-N	3.26	1.42	1.36
10	C	504	O0J	C9-S	3.14	1.75	1.70
10	D	503	O0J	C9-S	3.13	1.75	1.70
11	F	401	ACP	PG-O2G	2.96	1.61	1.54
11	F	401	ACP	PG-O3G	2.96	1.61	1.54
11	F	401	ACP	PB-O3A	2.84	1.61	1.58
11	F	401	ACP	C5-C4	2.52	1.47	1.40
5	C	501	GTP	C2-N3	2.32	1.38	1.33
8	B	501	GDP	C6-N1	-2.25	1.34	1.37
11	F	401	ACP	PB-O2B	2.25	1.61	1.56
8	D	501	GDP	C6-N1	-2.16	1.34	1.37

All (27) bond angle outliers are listed below:

Mol	Chain	Res	Type	Atoms	Z	Observed(°)	Ideal(°)
11	F	401	ACP	PB-O3A-PA	-4.08	119.61	132.56
9	B	504	MES	C5-N4-C3	3.87	117.53	108.83
11	F	401	ACP	C3'-C2'-C1'	3.63	106.44	100.98
11	F	401	ACP	N3-C2-N1	-3.14	123.77	128.68
5	C	501	GTP	C5-C6-N1	3.14	119.49	113.95
9	B	504	MES	C6-C5-N4	-3.13	105.36	110.10
5	C	501	GTP	C8-N7-C5	3.10	108.89	102.99
5	A	501	GTP	C8-N7-C5	2.91	108.54	102.99
5	A	501	GTP	C5-C6-N1	2.86	119.00	113.95
5	C	501	GTP	C2-N1-C6	-2.78	119.98	125.10
5	A	501	GTP	PA-O3A-PB	-2.65	123.72	132.83
9	B	504	MES	O1S-S-C8	2.57	110.01	106.92
11	F	401	ACP	C4-C5-N7	-2.56	106.73	109.40
5	C	501	GTP	PB-O3B-PG	-2.56	124.05	132.83

Continued on next page...

*Continued from previous page...*

Mol	Chain	Res	Type	Atoms	Z	Observed(°)	Ideal(°)
8	B	501	GDP	C5-C6-N1	2.54	118.44	113.95
8	D	501	GDP	PA-O3A-PB	-2.52	124.18	132.83
5	A	501	GTP	C2-N1-C6	-2.51	120.47	125.10
8	D	501	GDP	C8-N7-C5	2.47	107.69	102.99
5	C	501	GTP	PA-O3A-PB	-2.42	124.51	132.83
5	A	501	GTP	PB-O3B-PG	-2.33	124.84	132.83
8	B	501	GDP	PA-O3A-PB	-2.32	124.87	132.83
8	B	501	GDP	C8-N7-C5	2.30	107.37	102.99
8	D	501	GDP	C5-C6-N1	2.28	117.98	113.95
9	B	504	MES	O3S-S-C8	2.20	109.32	105.77
9	B	504	MES	C7-N4-C5	2.18	116.82	111.23
5	C	501	GTP	O6-C6-C5	-2.16	120.15	124.37
10	D	503	O0J	C8-C9-S	2.12	114.39	111.79

There are no chirality outliers.

All (40) torsion outliers are listed below:

Mol	Chain	Res	Type	Atoms
5	A	501	GTP	C5'-O5'-PA-O1A
5	C	501	GTP	C5'-O5'-PA-O1A
5	C	501	GTP	C5'-O5'-PA-O2A
8	B	501	GDP	C5'-O5'-PA-O1A
8	B	501	GDP	C5'-O5'-PA-O2A
8	D	501	GDP	C5'-O5'-PA-O3A
8	D	501	GDP	C5'-O5'-PA-O1A
8	D	501	GDP	C5'-O5'-PA-O2A
9	B	504	MES	C8-C7-N4-C5
11	F	401	ACP	PB-C3B-PG-O1G
11	F	401	ACP	PB-C3B-PG-O2G
11	F	401	ACP	PB-C3B-PG-O3G
11	F	401	ACP	PG-C3B-PB-O1B
11	F	401	ACP	PG-C3B-PB-O3A
11	F	401	ACP	C5'-O5'-PA-O1A
11	F	401	ACP	C5'-O5'-PA-O2A
9	B	504	MES	C7-C8-S-O3S
5	C	501	GTP	PB-O3B-PG-O1G
8	D	501	GDP	PA-O3A-PB-O1B
5	A	501	GTP	C5'-O5'-PA-O3A
5	A	501	GTP	C5'-O5'-PA-O2A
9	B	504	MES	C7-C8-S-O1S
9	B	504	MES	C7-C8-S-O2S
5	C	501	GTP	PB-O3A-PA-O2A

*Continued on next page...*

*Continued from previous page...*

Mol	Chain	Res	Type	Atoms
5	A	501	GTP	PB-O3B-PG-O1G
5	C	501	GTP	C4'-C5'-O5'-PA
5	A	501	GTP	PB-O3B-PG-O2G
5	A	501	GTP	PB-O3B-PG-O3G
5	C	501	GTP	PB-O3B-PG-O2G
5	C	501	GTP	PB-O3B-PG-O3G
8	D	501	GDP	PA-O3A-PB-O2B
8	D	501	GDP	PA-O3A-PB-O3B
11	F	401	ACP	PB-O3A-PA-O2A
5	C	501	GTP	C5'-O5'-PA-O3A
8	B	501	GDP	C5'-O5'-PA-O3A
11	F	401	ACP	C5'-O5'-PA-O3A
11	F	401	ACP	C3'-C4'-C5'-O5'
5	A	501	GTP	PB-O3A-PA-O1A
5	A	501	GTP	PB-O3A-PA-O2A
5	C	501	GTP	PB-O3A-PA-O1A

There are no ring outliers.

7 monomers are involved in 11 short contacts:

Mol	Chain	Res	Type	Clashes	Symm-Clashes
5	A	501	GTP	1	0
9	B	504	MES	1	0
11	F	401	ACP	2	0
10	D	503	O0J	2	0
5	C	501	GTP	1	0
8	B	501	GDP	1	0
8	D	501	GDP	3	0

The following is a two-dimensional graphical depiction of Mogul quality analysis of bond lengths, bond angles, torsion angles, and ring geometry for all instances of the Ligand of Interest. In addition, ligands with molecular weight > 250 and outliers as shown on the validation Tables will also be included. For torsion angles, if less than 5% of the Mogul distribution of torsion angles is within 10 degrees of the torsion angle in question, then that torsion angle is considered an outlier. Any bond that is central to one or more torsion angles identified as an outlier by Mogul will be highlighted in the graph. For rings, the root-mean-square deviation (RMSD) between the ring in question and similar rings identified by Mogul is calculated over all ring torsion angles. If the average RMSD is greater than 60 degrees and the minimal RMSD between the ring in question and any Mogul-identified rings is also greater than 60 degrees, then that ring is considered an outlier. The outliers are highlighted in purple. The color gray indicates Mogul did not find sufficient equivalents in the CSD to analyse the geometry.

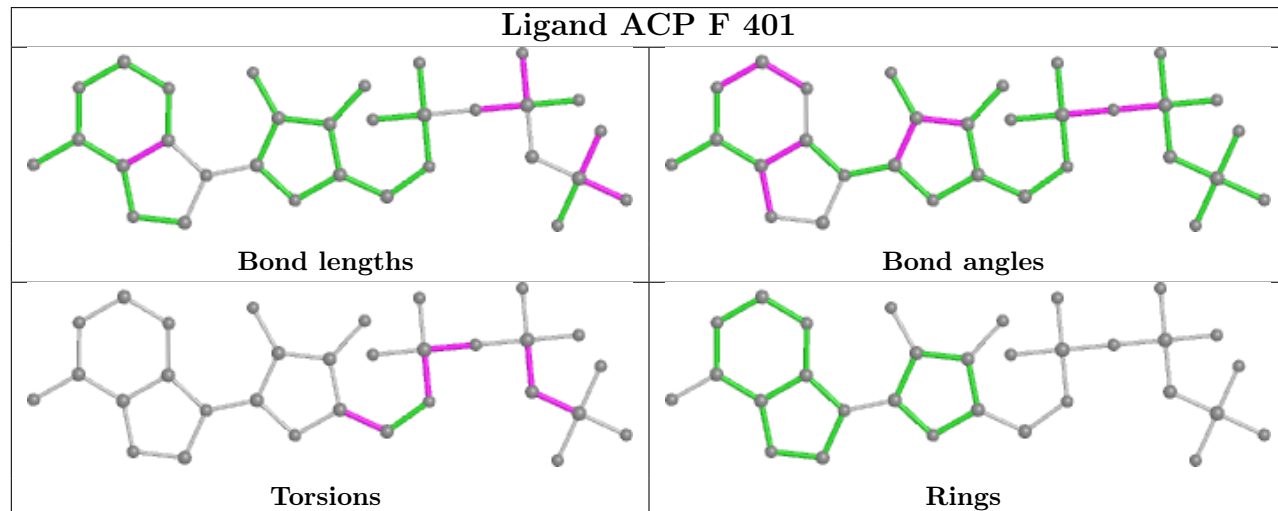
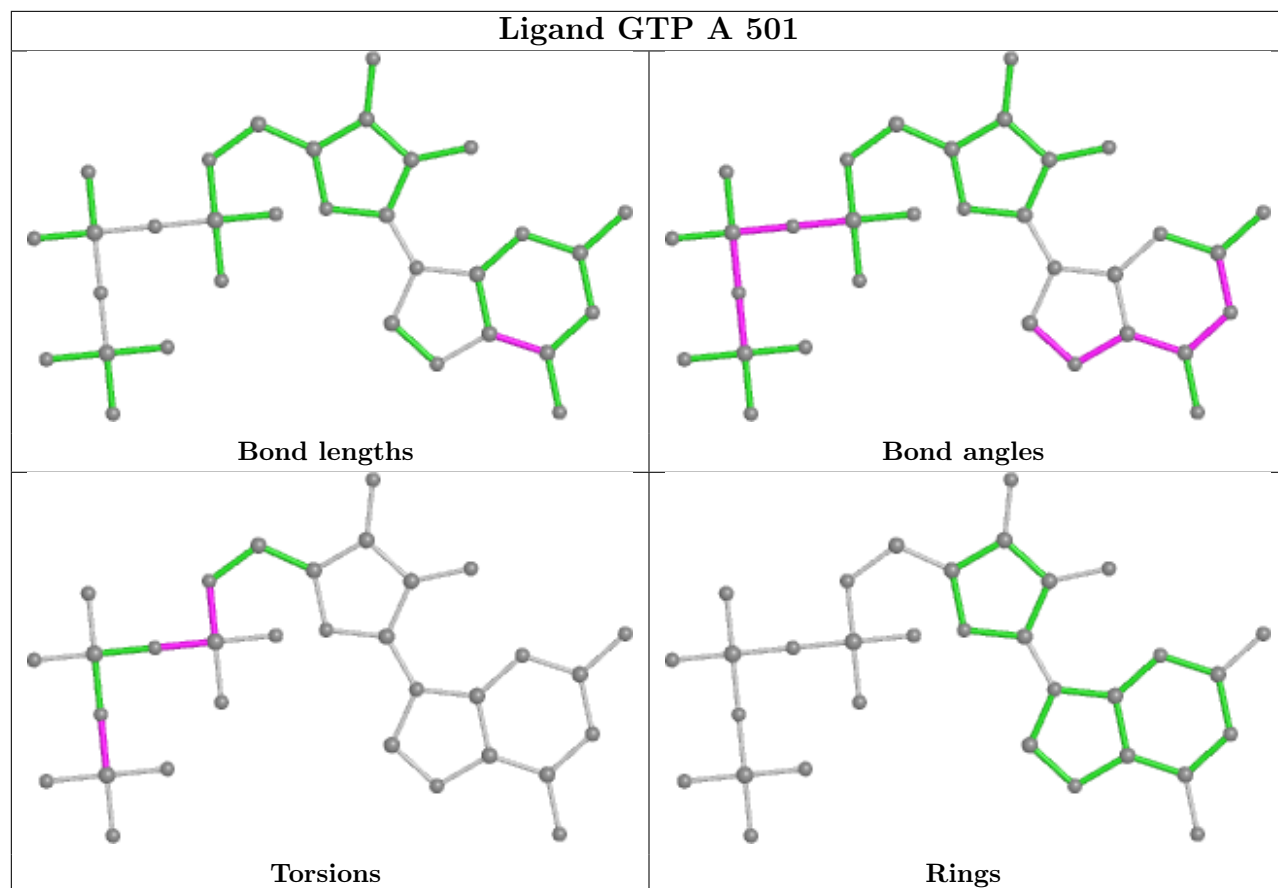

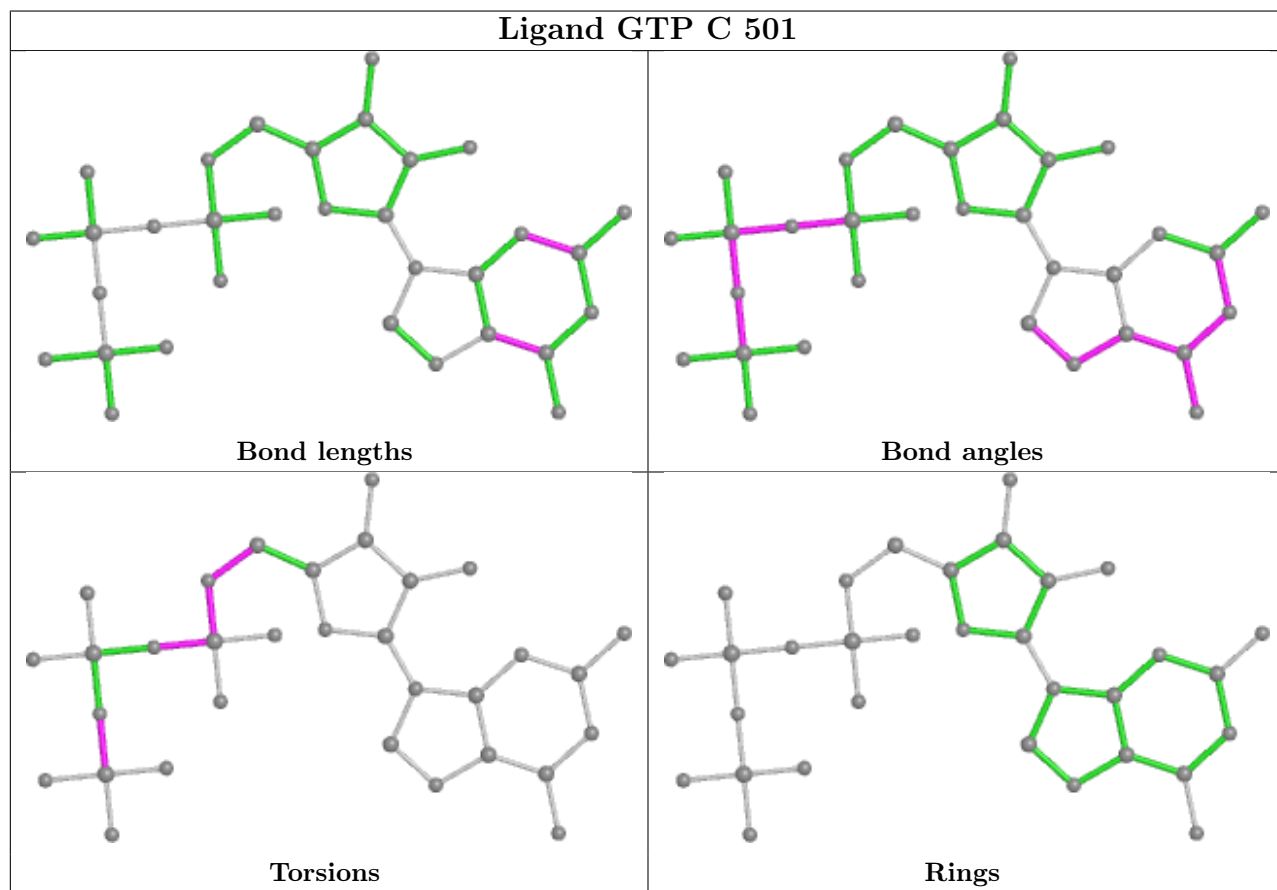
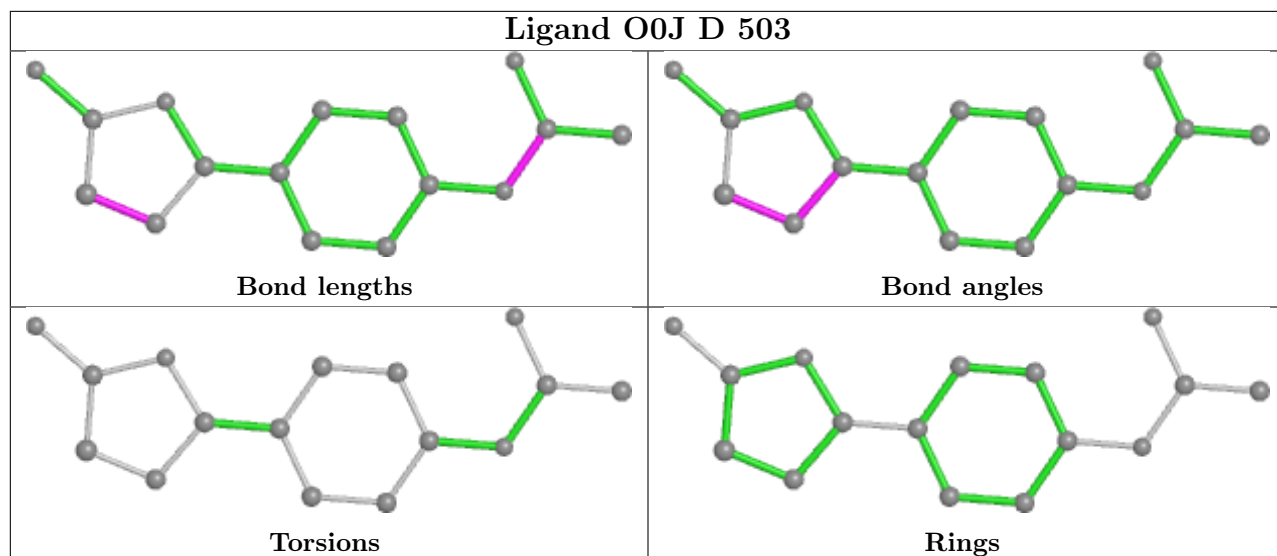

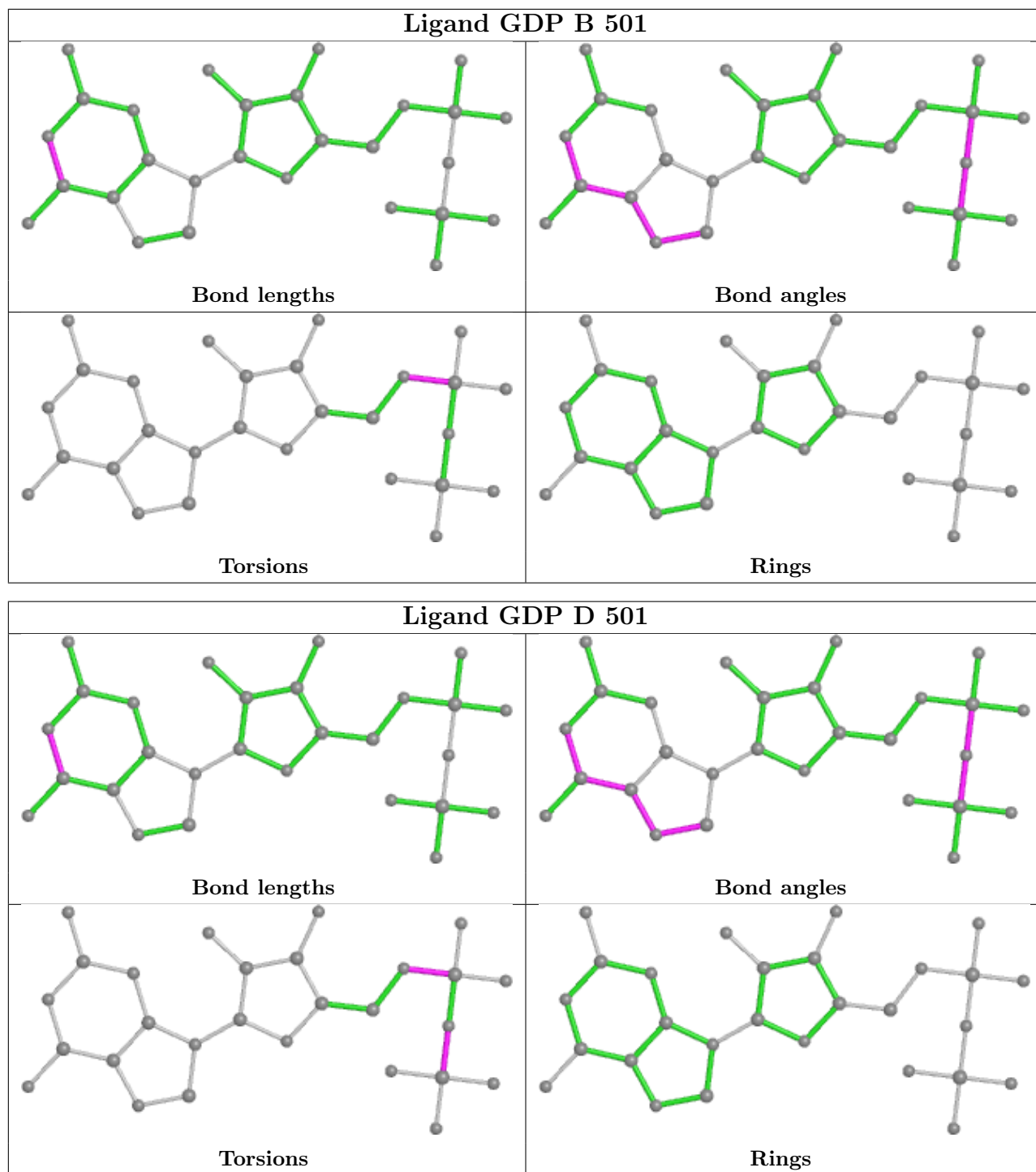

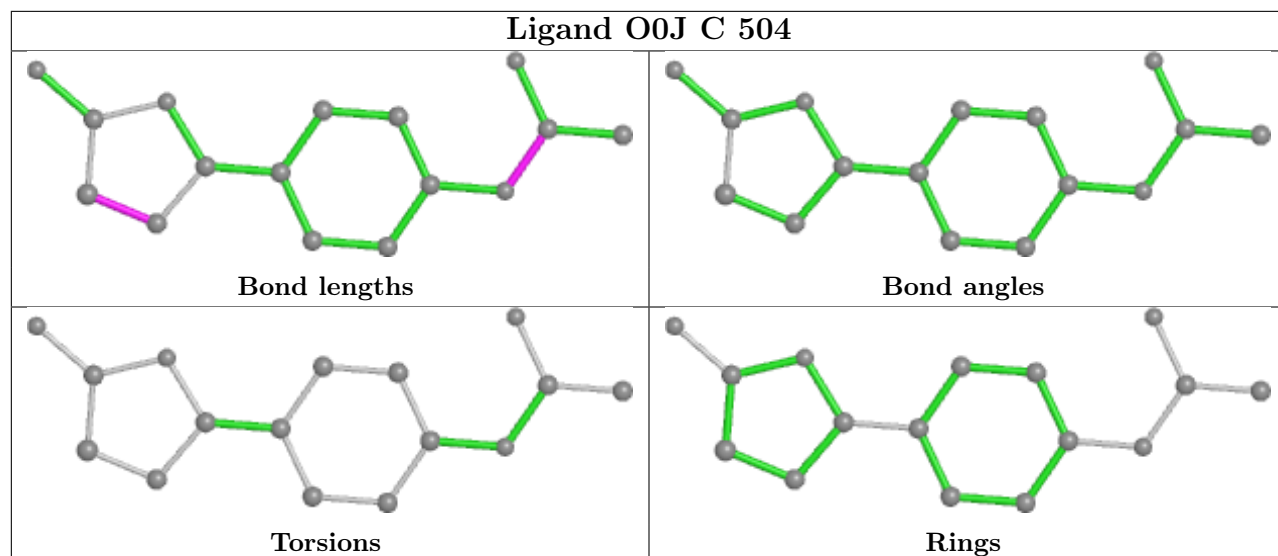

## 5.7 Other polymers [i](#)

There are no such residues in this entry.

## 5.8 Polymer linkage issues [i](#)

There are no chain breaks in this entry.



## 6 Fit of model and data

### 6.1 Protein, DNA and RNA chains

In the following table, the column labelled ‘#RSRZ > 2’ contains the number (and percentage) of RSRZ outliers, followed by percent RSRZ outliers for the chain as percentile scores relative to all X-ray entries and entries of similar resolution. The OWAB column contains the minimum, median, 95<sup>th</sup> percentile and maximum values of the occupancy-weighted average B-factor per residue. The column labelled ‘Q < 0.9’ lists the number of (and percentage) of residues with an average occupancy less than 0.9.

Mol	Chain	Analysed	<RSRZ>	#RSRZ>2	OWAB(Å <sup>2</sup> )	Q<0.9
1	A	437/451 (96%)	0.10	9 (2%) 63 70	23, 39, 66, 103	0
1	C	440/451 (97%)	0.19	4 (0%) 84 88	21, 32, 53, 73	0
2	B	424/445 (95%)	0.34	14 (3%) 46 53	19, 40, 71, 120	2 (0%)
2	D	426/445 (95%)	0.14	11 (2%) 56 63	25, 44, 66, 90	4 (0%)
3	E	123/143 (86%)	0.58	7 (5%) 23 30	28, 49, 82, 102	0
4	F	352/384 (91%)	0.99	56 (15%) 1 2	33, 60, 104, 121	0
All	All	2202/2319 (94%)	0.34	101 (4%) 32 39	19, 42, 81, 121	6 (0%)

All (101) RSRZ outliers are listed below:

Mol	Chain	Res	Type	RSRZ
2	B	281	GLN	10.6
3	E	26	PRO	9.5
4	F	173	ILE	8.3
3	E	27	PRO	7.8
2	B	276	THR	7.7
4	F	251	LYS	7.4
4	F	249	TYR	7.1
4	F	372	THR	7.0
4	F	371	PRO	6.8
4	F	105	LEU	6.1
2	B	284	ARG	6.1
4	F	103	THR	6.0
4	F	250	SER	5.4
2	D	280	SER	5.4
4	F	143	GLU	5.4
2	B	277	SER	5.1
4	F	90	SER	5.1
2	D	277	SER	5.1
4	F	253	TYR	5.1

*Continued on next page...*

*Continued from previous page...*

<b>Mol</b>	<b>Chain</b>	<b>Res</b>	<b>Type</b>	<b>RSRZ</b>
2	D	276	THR	5.0
4	F	231	ALA	4.8
4	F	240	LEU	4.7
4	F	104	ASN	4.7
2	D	278	ARG	4.6
3	E	28	SER	4.5
4	F	234	GLN	4.5
4	F	154	GLY	4.4
2	D	279	GLY	4.2
3	E	142	GLU	4.0
1	A	281	ALA	4.0
4	F	243	HIS	3.8
4	F	125	THR	3.8
2	D	57	THR	3.8
1	A	282	TYR	3.8
2	B	59	ASN	3.7
4	F	89	GLU	3.7
4	F	248	GLU	3.7
4	F	252	ASN	3.7
4	F	135	TYR	3.7
4	F	155	ALA	3.6
4	F	232	ASN	3.6
4	F	137	ARG	3.6
4	F	245	ILE	3.6
4	F	152	SER	3.6
4	F	233	PHE	3.5
1	C	440	VAL	3.4
4	F	379	HIS	3.4
4	F	236	LYS	3.3
4	F	244	CYS	3.2
1	A	179	THR	3.1
4	F	177	GLY	3.1
3	E	24	LEU	3.1
4	F	45	ASN	3.1
4	F	142	ARG	3.0
2	B	283	TYR	3.0
4	F	31	ARG	3.0
1	A	262	TYR	2.9
4	F	382	HIS	2.9
1	A	346	TRP	2.9
2	B	340	SER	2.9
2	B	275	LEU	2.9

*Continued on next page...*

*Continued from previous page...*

<b>Mol</b>	<b>Chain</b>	<b>Res</b>	<b>Type</b>	<b>RSRZ</b>
4	F	129	GLU	2.9
1	A	348	PRO	2.9
1	C	340	SER	2.8
2	B	57	THR	2.8
3	E	25	LYS	2.8
2	B	437	ASP	2.7
4	F	242	ASN	2.7
4	F	182	ILE	2.6
4	F	169	LEU	2.6
4	F	140	GLU	2.6
4	F	136	ASN	2.6
4	F	361	LEU	2.6
4	F	99	VAL	2.6
2	D	272	PHE	2.5
4	F	132	LEU	2.5
2	B	337	ASN	2.5
4	F	161	LEU	2.5
2	D	441	ASP	2.4
1	A	284	GLU	2.4
4	F	176	GLN	2.4
1	A	349	THR	2.4
4	F	340	GLN	2.4
4	F	131	PHE	2.4
2	D	401	ARG	2.3
1	A	326	LYS	2.3
1	C	286	LEU	2.3
2	D	335	VAL	2.2
4	F	225	SER	2.2
2	B	220	THR	2.2
2	B	325	MET	2.1
4	F	247	LYS	2.1
4	F	46	ARG	2.1
1	C	357	TYR	2.1
2	B	338	LYS	2.1
4	F	342	LEU	2.1
2	D	218	LYS	2.1
4	F	194	PRO	2.1
4	F	381	HIS	2.0
4	F	32	LYS	2.0
3	E	143	ALA	2.0

## 6.2 Non-standard residues in protein, DNA, RNA chains [i](#)

There are no non-standard protein/DNA/RNA residues in this entry.

## 6.3 Carbohydrates [i](#)

There are no monosaccharides in this entry.

## 6.4 Ligands [i](#)

In the following table, the Atoms column lists the number of modelled atoms in the group and the number defined in the chemical component dictionary. The B-factors column lists the minimum, median, 95<sup>th</sup> percentile and maximum values of B factors of atoms in the group. The column labelled 'Q< 0.9' lists the number of atoms with occupancy less than 0.9.

Mol	Type	Chain	Res	Atoms	RSCC	RSR	B-factors(Å <sup>2</sup> )	Q<0.9
11	ACP	F	401	31/31	0.85	0.17	56,75,86,101	0
7	CA	B	503	1/1	0.86	0.12	76,76,76,76	0
9	MES	B	504	12/12	0.91	0.13	33,45,64,65	0
10	O0J	D	503	16/16	0.92	0.20	27,45,54,64	0
7	CA	A	503	1/1	0.93	0.07	66,66,66,66	0
10	O0J	C	504	16/16	0.93	0.14	26,39,59,65	0
6	MG	D	502	1/1	0.95	0.08	40,40,40,40	0
7	CA	C	503	1/1	0.96	0.11	43,43,43,43	0
8	GDP	D	501	28/28	0.96	0.13	34,41,51,60	0
6	MG	F	402	1/1	0.96	0.06	57,57,57,57	0
7	CA	E	201	1/1	0.97	0.13	74,74,74,74	0
6	MG	C	502	1/1	0.98	0.14	23,23,23,23	0
5	GTP	A	501	32/32	0.98	0.14	20,27,33,34	0
6	MG	A	502	1/1	0.98	0.12	27,27,27,27	0
8	GDP	B	501	28/28	0.99	0.17	19,26,31,35	0
6	MG	B	502	1/1	0.99	0.19	20,20,20,20	0
5	GTP	C	501	32/32	0.99	0.16	18,22,26,28	0

The following is a graphical depiction of the model fit to experimental electron density of all instances of the Ligand of Interest. In addition, ligands with molecular weight > 250 and outliers as shown on the geometry validation Tables will also be included. Each fit is shown from different orientation to approximate a three-dimensional view.

**Electron density around ACP F 401:**

$2mF_o-DF_c$  (at 0.7 rmsd) in gray  
 $mF_o-DF_c$  (at 3 rmsd) in purple (negative)  
and green (positive)

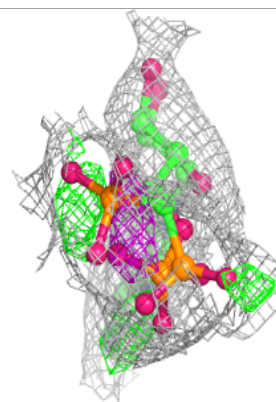
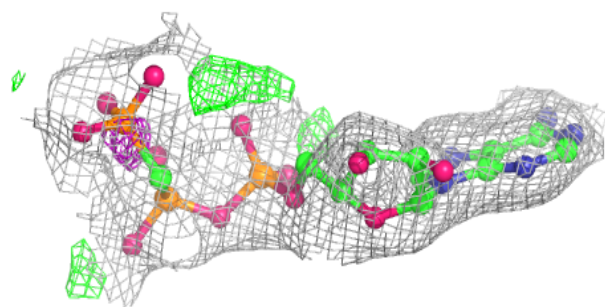
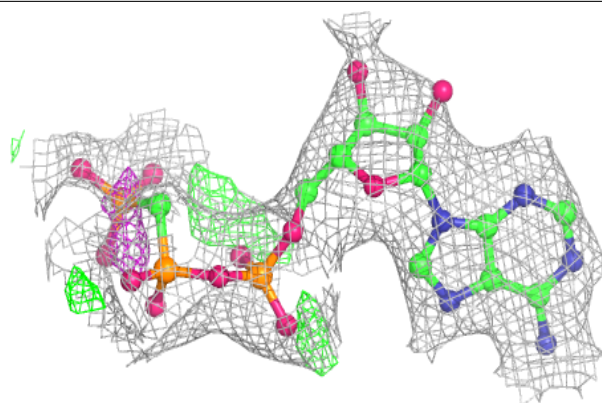
**Electron density around O0J D 503:**

$2mF_o-DF_c$  (at 0.7 rmsd) in gray  
 $mF_o-DF_c$  (at 3 rmsd) in purple (negative)  
and green (positive)

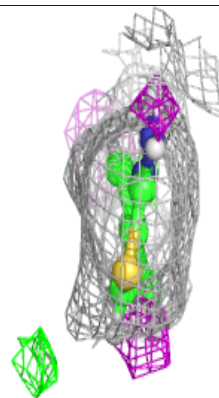
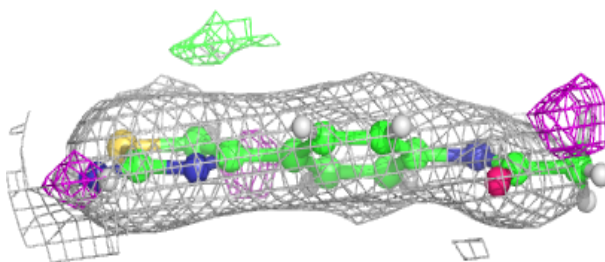
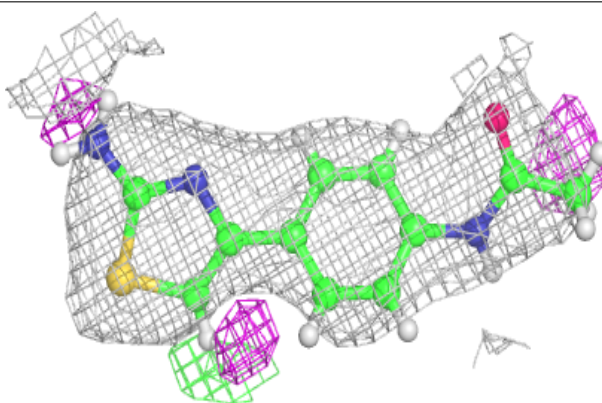

**Electron density around O0J C 504:**

$2mF_o-DF_c$  (at 0.7 rmsd) in gray  
 $mF_o-DF_c$  (at 3 rmsd) in purple (negative)  
and green (positive)

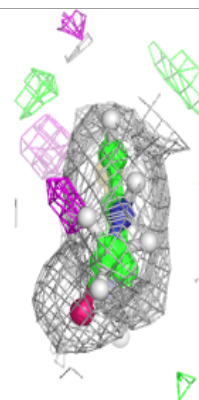
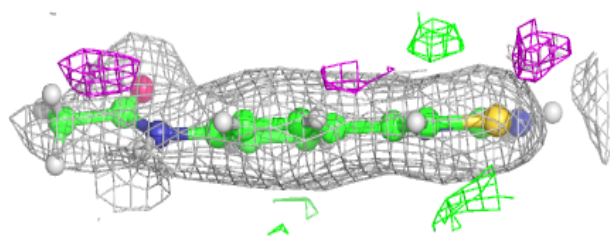
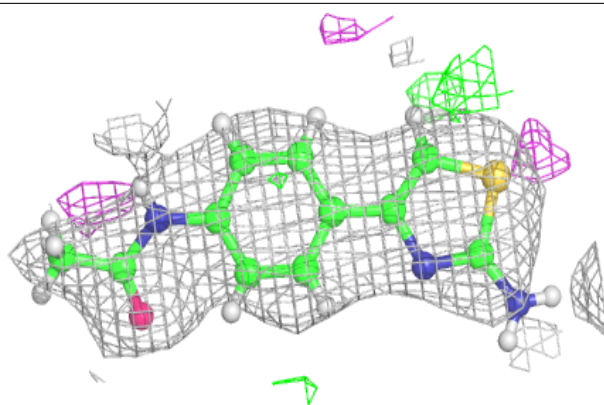
**Electron density around GDP D 501:**

$2mF_o-DF_c$  (at 0.7 rmsd) in gray  
 $mF_o-DF_c$  (at 3 rmsd) in purple (negative)  
and green (positive)

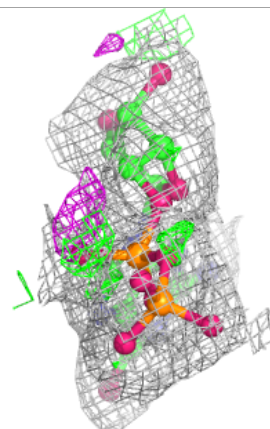
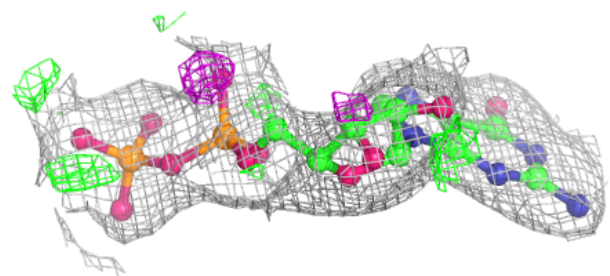
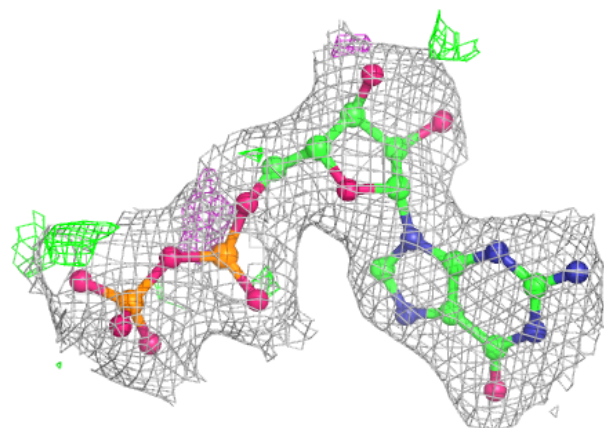

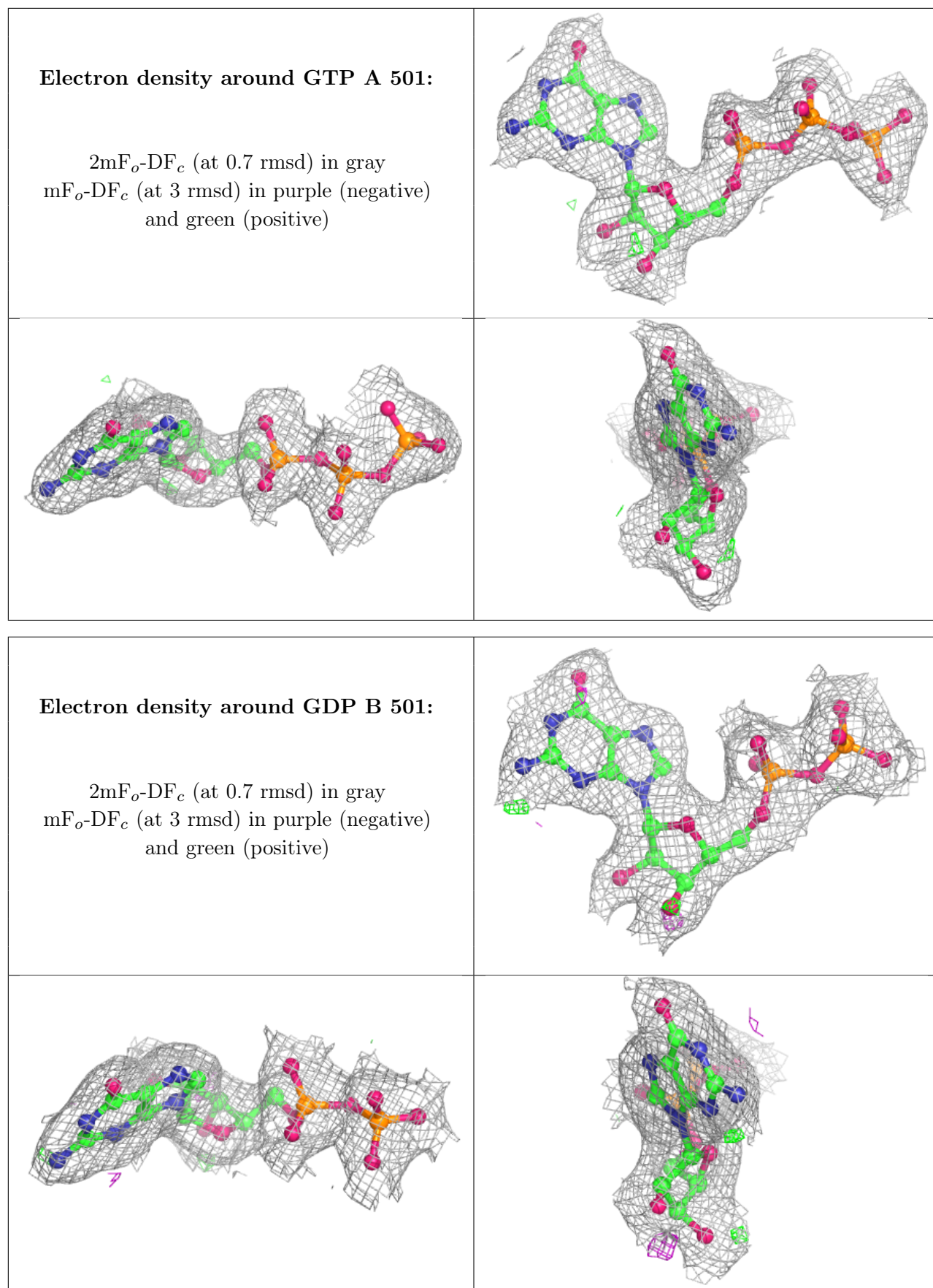

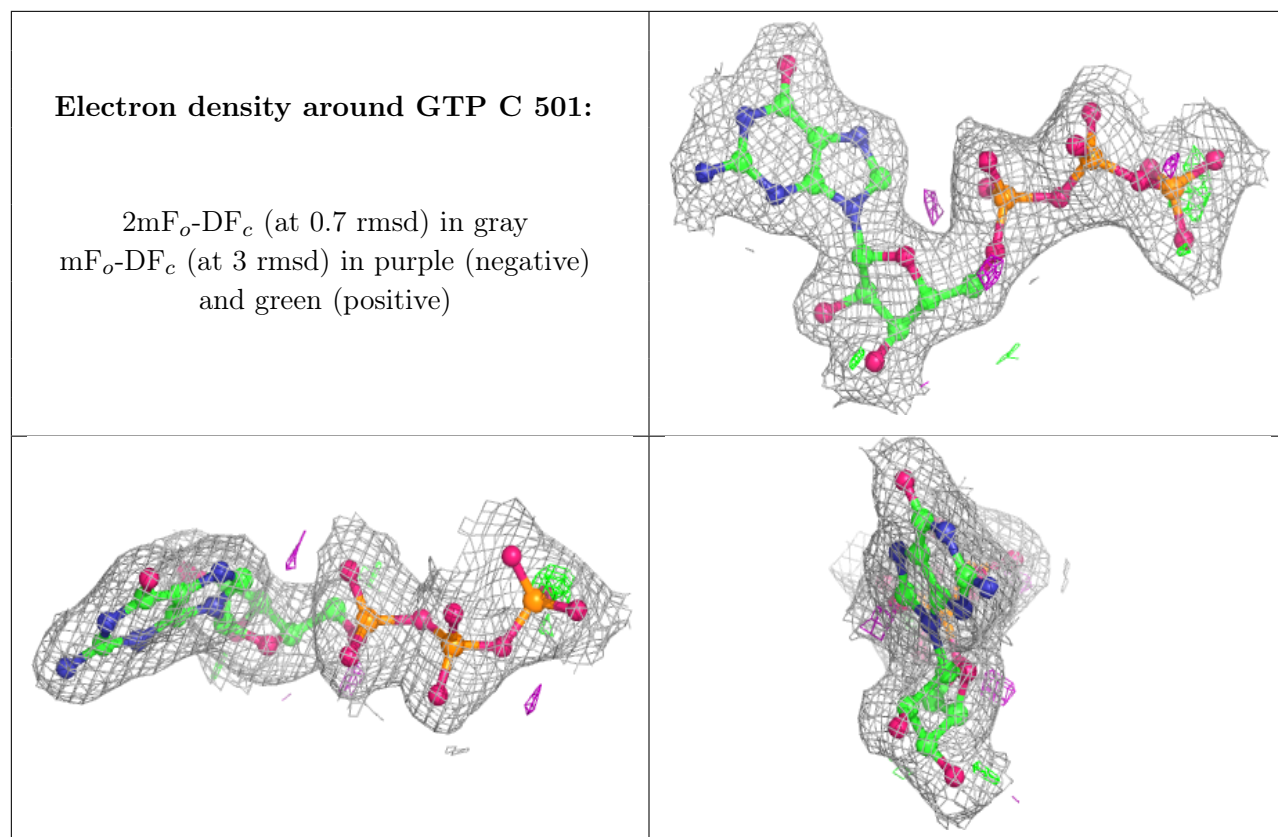

## 6.5 Other polymers [i](#)

There are no such residues in this entry.