



wwPDB X-ray Structure Validation Summary Report ⓘ

Nov 5, 2023 – 09:11 PM EST

PDB ID : 1S32
Title : Molecular Recognition of the Nucleosomal 'Supergroove'
Authors : Edayathumangalam, R.S.; Weyermann, P.; Gottesfeld, J.M.; Dervan, P.B.;
Luger, K.
Deposited on : 2004-01-12
Resolution : 2.05 Å(reported)

This is a wwPDB X-ray Structure Validation Summary Report for a publicly released PDB entry.

We welcome your comments at validation@mail.wwpdb.org

A user guide is available at

<https://www.wwpdb.org/validation/2017/XrayValidationReportHelp>

with specific help available everywhere you see the ⓘ symbol.

The types of validation reports are described at

<http://www.wwpdb.org/validation/2017/FAQs#types>.

The following versions of software and data (see [references ⓘ](#)) were used in the production of this report:

MolProbity : 4.02b-467
Mogul : 1.8.5 (274361), CSD as541be (2020)
Xtriage (Phenix) : 1.13
EDS : 2.36
Percentile statistics : 20191225.v01 (using entries in the PDB archive December 25th 2019)
Refmac : 5.8.0158
CCP4 : 7.0.044 (Gargrove)
Ideal geometry (proteins) : Engh & Huber (2001)
Ideal geometry (DNA, RNA) : Parkinson et al. (1996)
Validation Pipeline (wwPDB-VP) : 2.36

1 Overall quality at a glance i

The following experimental techniques were used to determine the structure:

X-RAY DIFFRACTION

The reported resolution of this entry is 2.05 Å.

Percentile scores (ranging between 0-100) for global validation metrics of the entry are shown in the following graphic. The table shows the number of entries on which the scores are based.

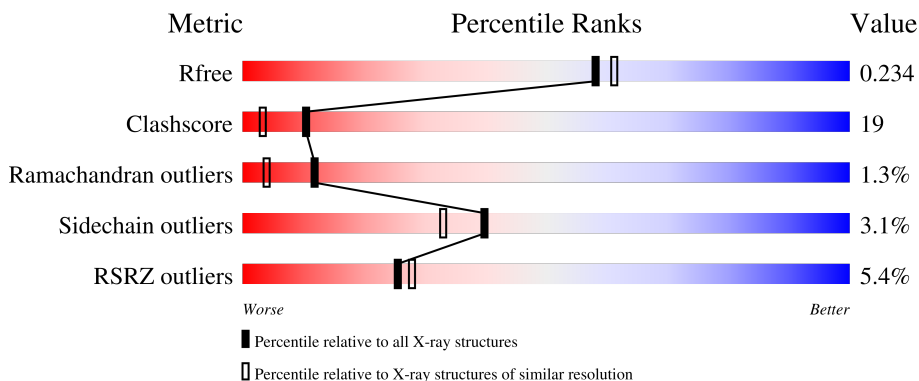

Metric	Whole archive (#Entries)	Similar resolution (#Entries, resolution range(Å))
R_{free}	130704	1692 (2.04-2.04)
Clashscore	141614	1773 (2.04-2.04)
Ramachandran outliers	138981	1752 (2.04-2.04)
Sidechain outliers	138945	1752 (2.04-2.04)
RSRZ outliers	127900	1672 (2.04-2.04)

The table below summarises the geometric issues observed across the polymeric chains and their fit to the electron density. The red, orange, yellow and green segments of the lower bar indicate the fraction of residues that contain outliers for ≥ 3 , 2, 1 and 0 types of geometric quality criteria respectively. A grey segment represents the fraction of residues that are not modelled. The numeric value for each fraction is indicated below the corresponding segment, with a dot representing fractions $\leq 5\%$. The upper red bar (where present) indicates the fraction of residues that have poor fit to the electron density. The numeric value is given above the bar.

Mol	Chain	Length	Quality of chain
1	I	146	<div style="display: flex; align-items: center;"> <div style="width: 2%; height: 10px; background-color: red; margin-right: 2px;"></div> <div style="width: 60%; height: 10px; background-color: green; margin-right: 2px;"></div> <div style="width: 40%; height: 10px; background-color: yellow; margin-right: 2px;"></div> </div> <p style="margin-left: 20px;">2% 60% 40%</p>
1	J	146	<div style="display: flex; align-items: center;"> <div style="width: 3%; height: 10px; background-color: red; margin-right: 2px;"></div> <div style="width: 49%; height: 10px; background-color: green; margin-right: 2px;"></div> <div style="width: 51%; height: 10px; background-color: yellow; margin-right: 2px;"></div> </div> <p style="margin-left: 20px;">3% 49% 51%</p>
2	A	135	<div style="display: flex; align-items: center;"> <div style="width: 2%; height: 10px; background-color: red; margin-right: 2px;"></div> <div style="width: 52%; height: 10px; background-color: green; margin-right: 2px;"></div> <div style="width: 19%; height: 10px; background-color: yellow; margin-right: 2px;"></div> <div style="width: 27%; height: 10px; background-color: grey; margin-right: 2px;"></div> </div> <p style="margin-left: 20px;">2% 52% 19% • 27%</p>
2	E	135	<div style="display: flex; align-items: center;"> <div style="width: 4%; height: 10px; background-color: red; margin-right: 2px;"></div> <div style="width: 59%; height: 10px; background-color: green; margin-right: 2px;"></div> <div style="width: 14%; height: 10px; background-color: yellow; margin-right: 2px;"></div> <div style="width: 27%; height: 10px; background-color: grey; margin-right: 2px;"></div> </div> <p style="margin-left: 20px;">4% 59% 14% • 27%</p>
3	B	102	<div style="display: flex; align-items: center;"> <div style="width: 4%; height: 10px; background-color: red; margin-right: 2px;"></div> <div style="width: 62%; height: 10px; background-color: green; margin-right: 2px;"></div> <div style="width: 14%; height: 10px; background-color: yellow; margin-right: 2px;"></div> <div style="width: 21%; height: 10px; background-color: grey; margin-right: 2px;"></div> </div> <p style="margin-left: 20px;">4% 62% 14% • 21%</p>

Continued on next page...

Continued from previous page...

Mol	Chain	Length	Quality of chain
3	F	102	
4	C	119	
4	G	119	
5	D	122	
5	H	122	

The following table lists non-polymeric compounds, carbohydrate monomers and non-standard residues in protein, DNA, RNA chains that are outliers for geometric or electron-density-fit criteria:

Mol	Type	Chain	Res	Chirality	Geometry	Clashes	Electron density
11	DIB	I	1611	-	-	X	X
11	DIB	I	1631	-	-	-	X
12	OGG	J	1700	-	X	X	-
7	IMT	I	1601	-	-	X	-
7	IMT	I	1603	-	-	X	-
7	IMT	I	1621	-	-	X	-
7	IMT	I	1623	-	-	X	-
8	PYB	I	1602	-	-	X	-
8	PYB	I	1604	-	-	X	-
8	PYB	I	1606	-	-	X	-
8	PYB	I	1607	-	-	X	-
8	PYB	I	1608	-	-	X	-
8	PYB	I	1622	-	-	X	-
8	PYB	I	1624	-	-	X	-
8	PYB	I	1626	-	-	X	-
8	PYB	I	1627	-	-	X	-
8	PYB	I	1628	-	-	X	-
8	PYB	I	1629	-	-	X	-
9	ABU	I	1605	-	X	X	-
9	ABU	I	1625	-	X	X	-

2 Entry composition [i](#)

There are 14 unique types of molecules in this entry. The entry contains 13437 atoms, of which 0 are hydrogens and 0 are deuteriums.

In the tables below, the ZeroOcc column contains the number of atoms modelled with zero occupancy, the AltConf column contains the number of residues with at least one atom in alternate conformation and the Trace column contains the number of residues modelled with at most 2 atoms.

- Molecule 1 is a DNA chain called palindromic alpha-satellite 146 bp DNA fragment.

Mol	Chain	Residues	Atoms					ZeroOcc	AltConf	Trace
			Total	C	N	O	P			
1	I	146	2990	1430	541	874	145	0	0	0
1	J	146	2990	1430	541	874	145	0	0	0

- Molecule 2 is a protein called Histone H3.

Mol	Chain	Residues	Atoms					ZeroOcc	AltConf	Trace
			Total	C	N	O	S			
2	A	98	816	514	157	141	4	0	1	0
2	E	99	867	547	170	146	4	0	5	0

- Molecule 3 is a protein called Histone H4.

Mol	Chain	Residues	Atoms					ZeroOcc	AltConf	Trace
			Total	C	N	O	S			
3	B	81	666	418	132	115	1	0	2	0
3	F	88	730	457	151	121	1	0	2	0

- Molecule 4 is a protein called Histone H2A.

Mol	Chain	Residues	Atoms				ZeroOcc	AltConf	Trace
			Total	C	N	O			
4	C	107	834	525	165	144	0	1	0
4	G	107	828	522	162	144	0	0	0

- Molecule 5 is a protein called Histone H2B.

Mol	Chain	Residues	Atoms					ZeroOcc	AltConf	Trace
5	D	101	Total	C	N	O	S	0	3	0
			828	520	154	152	2			
5	H	98	Total	C	N	O	S	0	2	0
			792	496	148	146	2			

- Molecule 6 is MANGANESE (II) ION (three-letter code: MN) (formula: Mn).

Mol	Chain	Residues	Atoms		ZeroOcc	AltConf
6	I	7	Total	Mn	0	0
			7	7		
6	J	6	Total	Mn	0	0
			6	6		
6	E	1	Total	Mn	0	0
			1	1		

- Molecule 7 is 4-AMINO-(1-METHYLIMIDAZOLE)-2-CARBOXYLIC ACID (three-letter code: IMT) (formula: C₅H₇N₃O₂).

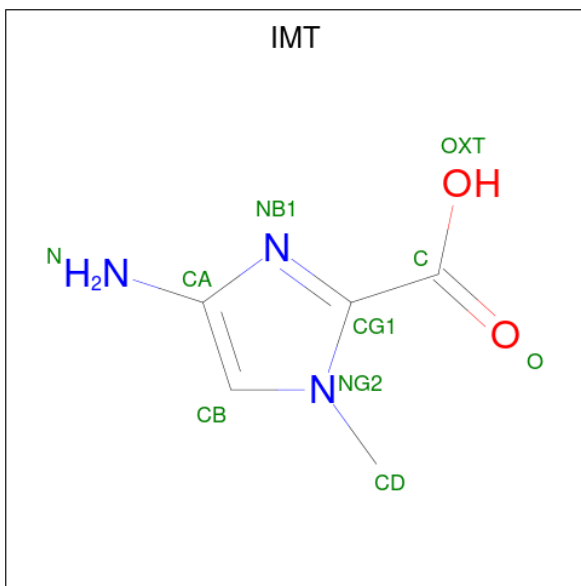

Mol	Chain	Residues	Atoms				ZeroOcc	AltConf
7	I	1	Total	C	N	O	0	0
			8	5	2	1		
7	I	1	Total	C	N	O	0	0
			9	5	3	1		
7	I	1	Total	C	N	O	0	0
			8	5	2	1		
7	I	1	Total	C	N	O	0	0
			9	5	3	1		

- Molecule 8 is 4-AMINO-(1-METHYLPYRROLE)-2-CARBOXYLIC ACID (three-letter code: PYB) (formula: C₆H₈N₂O₂).

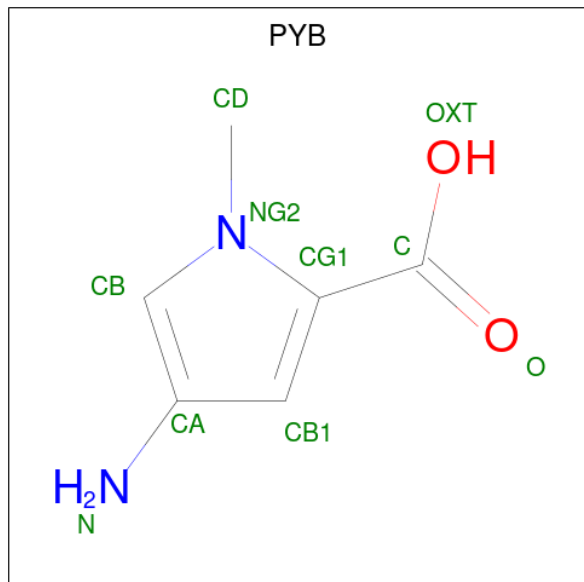

Mol	Chain	Residues	Atoms				ZeroOcc	AltConf
8	I	1	Total	C	N	O	0	0
			9	6	2	1		
8	I	1	Total	C	N	O	0	0
			9	6	2	1		
8	I	1	Total	C	N	O	0	0
			9	6	2	1		
8	I	1	Total	C	N	O	0	0
			9	6	2	1		
8	I	1	Total	C	N	O	0	0
			9	6	2	1		
8	I	1	Total	C	N	O	0	0
			9	6	2	1		
8	I	1	Total	C	N	O	0	0
			9	6	2	1		
8	I	1	Total	C	N	O	0	0
			9	6	2	1		
8	I	1	Total	C	N	O	0	0
			9	6	2	1		

- Molecule 9 is GAMMA-AMINO-BUTANOIC ACID (three-letter code: ABU) (formula: $C_4H_9NO_2$).

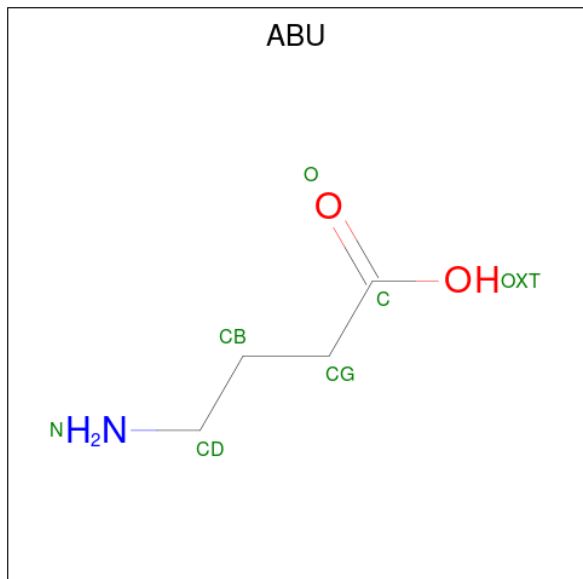

Mol	Chain	Residues	Atoms				ZeroOcc	AltConf
			Total	C	N	O		
9	I	1	6	4	1	1	0	0
9	I	1	6	4	1	1	0	0

- Molecule 10 is BETA-ALANINE (three-letter code: BAL) (formula: $C_3H_7NO_2$).

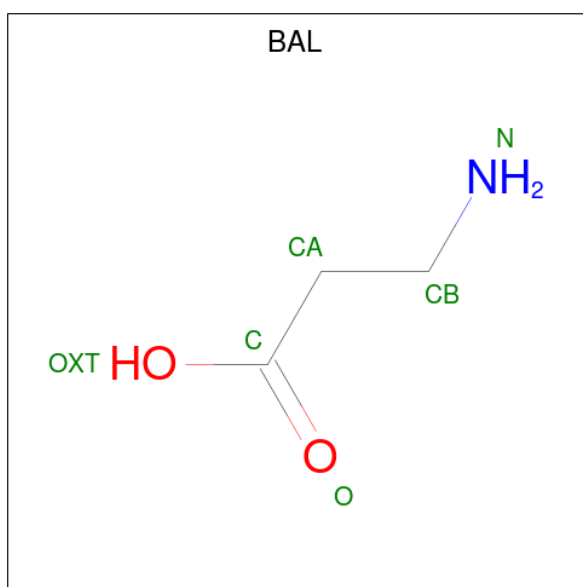

Mol	Chain	Residues	Atoms				ZeroOcc	AltConf
10	I	1	Total	C	N	O	0	0
			5	3	1	1		
10	I	1	Total	C	N	O	0	0
			5	3	1	1		

- Molecule 11 is 3-AMINO-(DIMETHYLPROPYLAMINE) (three-letter code: DIB) (formula: $C_5H_{14}N_2$).

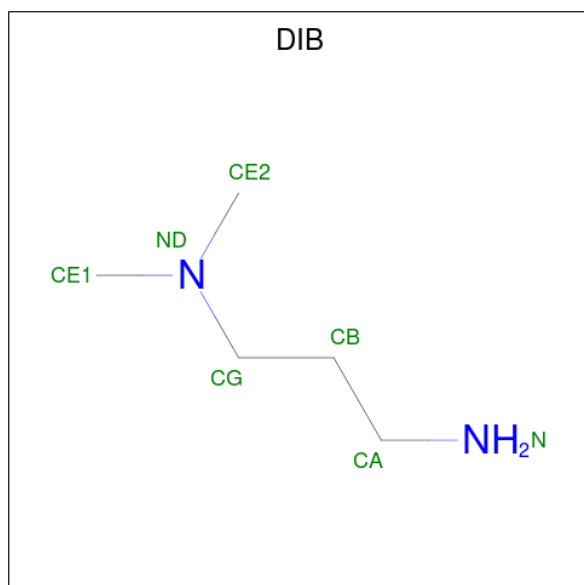

Mol	Chain	Residues	Atoms			ZeroOcc	AltConf
11	I	1	Total	C	N	0	0
			7	5	2		
11	I	1	Total	C	N	0	0
			7	5	2		

- Molecule 12 is 2-(2-CARBAMOYLMETHOXY-ETHOXY)-ACETAMIDE (three-letter code: OGG) (formula: $C_6H_{12}N_2O_4$).

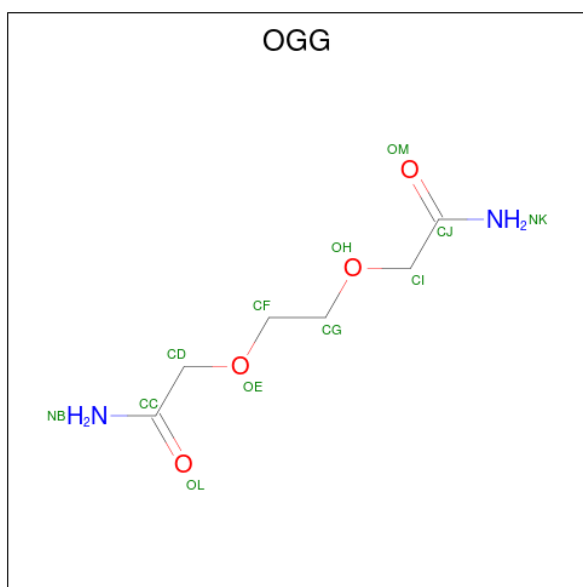

Mol	Chain	Residues	Atoms				ZeroOcc	AltConf
12	J	1	Total	C	N	O	0	0
			12	6	2	4		

- Molecule 13 is CHLORIDE ION (three-letter code: CL) (formula: Cl).

Mol	Chain	Residues	Atoms		ZeroOcc	AltConf
13	A	1	Total	Cl	0	0
			1	1		
13	D	1	Total	Cl	0	0
			1	1		
13	E	1	Total	Cl	0	0
			1	1		
13	G	1	Total	Cl	0	0
			1	1		

- Molecule 14 is water.

Mol	Chain	Residues	Atoms		ZeroOcc	AltConf
14	I	145	Total	O	1	0
			145	145		
14	J	151	Total	O	0	0
			151	151		
14	A	77	Total	O	0	0
			77	77		
14	B	53	Total	O	0	0
			53	53		

Continued on next page...

Continued from previous page...

Mol	Chain	Residues	Atoms		ZeroOcc	AltConf
14	C	109	Total 109	O 109	0	0
14	D	62	Total 62	O 62	0	0
14	E	97	Total 97	O 97	0	0
14	F	85	Total 85	O 85	0	0
14	G	80	Total 80	O 80	0	0
14	H	29	Total 29	O 29	0	0

3 Residue-property plots [i](#)

These plots are drawn for all protein, RNA, DNA and oligosaccharide chains in the entry. The first graphic for a chain summarises the proportions of the various outlier classes displayed in the second graphic. The second graphic shows the sequence view annotated by issues in geometry and electron density. Residues are color-coded according to the number of geometric quality criteria for which they contain at least one outlier: green = 0, yellow = 1, orange = 2 and red = 3 or more. A red dot above a residue indicates a poor fit to the electron density ($RSRZ > 2$). Stretches of 2 or more consecutive residues without any outlier are shown as a green connector. Residues present in the sample, but not in the model, are shown in grey.

- Molecule 1: palindromic alpha-satellite 146 bp DNA fragment

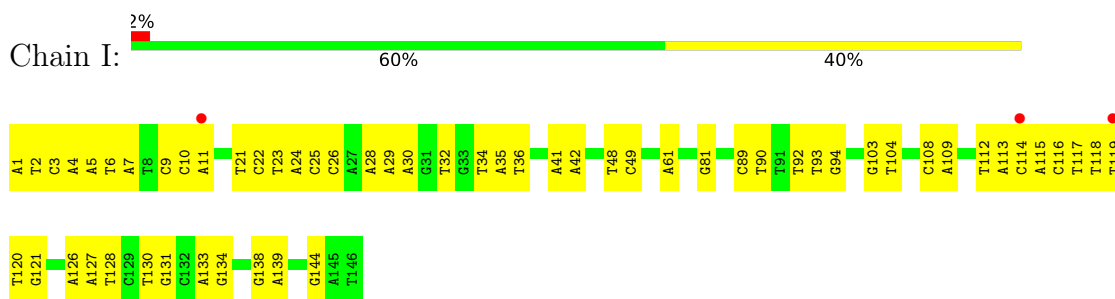

- Molecule 1: palindromic alpha-satellite 146 bp DNA fragment



- Molecule 2: Histone H3

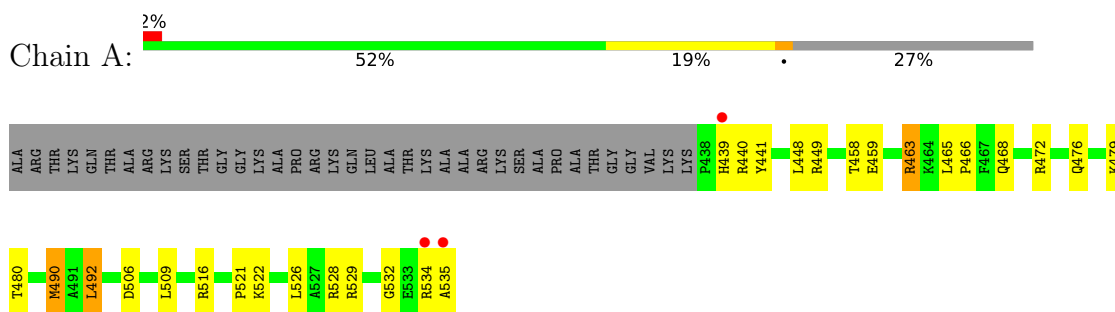

- Molecule 2: Histone H3

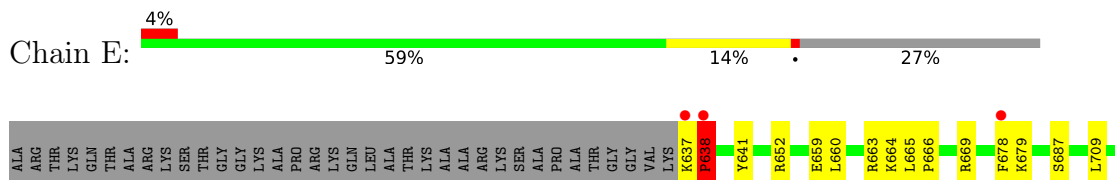

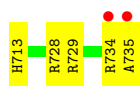

• Molecule 3: Histone H4

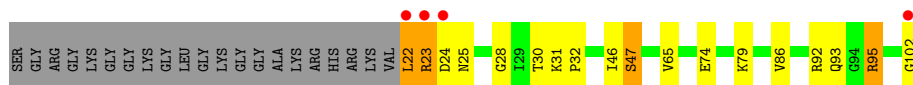

• Molecule 3: Histone H4



• Molecule 4: Histone H2A

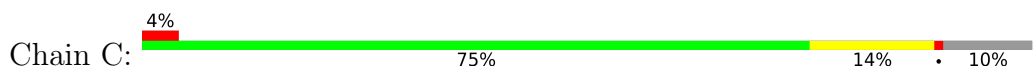

• Molecule 4: Histone H2A

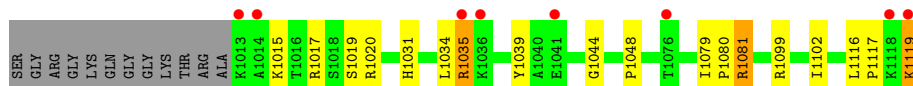
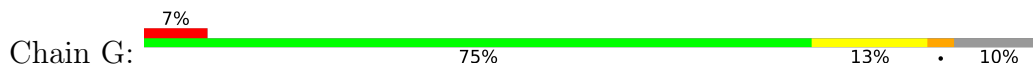

• Molecule 5: Histone H2B

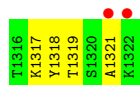
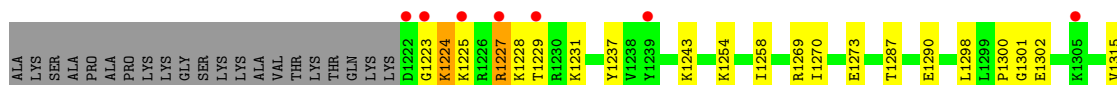

• Molecule 5: Histone H2B



ALA	
LYS	
SER	
ALA	
PRO	
ALA	
PRO	
LYS	
GLY	
SER	
LYS	
ALA	
VAL	
THR	
LYS	
THR	
GLN	
LYS	
LYS	
ASP	
GLY	
LYS	
K1425	●
R1426	●
R1427	●
K1428	●
T1429	●
R1430	●
S1433	
Y1439	●
K1443	
Q1444	●
V1445	
H1446	
I1458	
G1501	
K1505	●
K1517	
Y1518	●
T1519	
S1520	●
A1521	●
K1522	●

4 Data and refinement statistics

Property	Value	Source
Space group	P 21 21 21	Depositor
Cell constants a, b, c, α , β , γ	105.35Å 109.72Å 181.83Å 90.00° 90.00° 90.00°	Depositor
Resolution (Å)	100.00 – 2.05 93.94 – 2.05	Depositor EDS
% Data completeness (in resolution range)	90.7 (100.00-2.05) 91.2 (93.94-2.05)	Depositor EDS
R_{merge}	0.08	Depositor
R_{sym}	(Not available)	Depositor
$\langle I/\sigma(I) \rangle$ ¹	1.89 (at 2.05Å)	Xtrriage
Refinement program	CNS 1.0	Depositor
R, R_{free}	0.219 , 0.243 0.212 , 0.234	Depositor DCC
R_{free} test set	6276 reflections (5.04%)	wwPDB-VP
Wilson B-factor (Å ²)	44.1	Xtrriage
Anisotropy	0.242	Xtrriage
Bulk solvent k_{sol} (e/Å ³), B_{sol} (Å ²)	0.29 , 54.2	EDS
L-test for twinning ²	$\langle L \rangle = 0.48$, $\langle L^2 \rangle = 0.32$	Xtrriage
Estimated twinning fraction	0.016 for k,h,-l	Xtrriage
F_o, F_c correlation	0.95	EDS
Total number of atoms	13437	wwPDB-VP
Average B, all atoms (Å ²)	73.0	wwPDB-VP

Xtrriage's analysis on translational NCS is as follows: *The largest off-origin peak in the Patterson function is 2.86% of the height of the origin peak. No significant pseudotranslation is detected.*

¹Intensities estimated from amplitudes.

²Theoretical values of $\langle |L| \rangle$, $\langle L^2 \rangle$ for acentric reflections are 0.5, 0.333 respectively for untwinned datasets, and 0.375, 0.2 for perfectly twinned datasets.

5 Model quality i

5.1 Standard geometry i

Bond lengths and bond angles in the following residue types are not validated in this section: IMT, PYB, BAL, ABU, DIB, CL, MN, OGG

The Z score for a bond length (or angle) is the number of standard deviations the observed value is removed from the expected value. A bond length (or angle) with $|Z| > 5$ is considered an outlier worth inspection. RMSZ is the root-mean-square of all Z scores of the bond lengths (or angles).

Mol	Chain	Bond lengths		Bond angles	
		RMSZ	# Z >5	RMSZ	# Z >5
1	I	0.26	0/3354	0.68	0/5175
1	J	0.27	0/3354	0.68	0/5175
2	A	0.38	0/828	0.57	0/1109
2	E	0.51	0/880	0.64	1/1176 (0.1%)
3	B	0.37	0/673	0.61	0/899
3	F	0.42	0/738	0.71	1/983 (0.1%)
4	C	0.44	0/844	0.60	1/1138 (0.1%)
4	G	0.33	0/838	0.51	0/1128
5	D	0.41	0/840	0.62	0/1124
5	H	0.33	0/804	0.53	0/1077
All	All	0.34	0/13153	0.65	3/18984 (0.0%)

There are no bond length outliers.

All (3) bond angle outliers are listed below:

Mol	Chain	Res	Type	Atoms	Z	Observed(°)	Ideal(°)
3	F	218	HIS	N-CA-C	5.79	126.63	111.00
2	E	735	ALA	N-CA-C	5.11	124.78	111.00
4	C	813	LYS	N-CA-C	5.06	124.67	111.00

There are no chirality outliers.

There are no planarity outliers.

5.2 Too-close contacts i

In the following table, the Non-H and H(model) columns list the number of non-hydrogen atoms and hydrogen atoms in the chain respectively. The H(added) column lists the number of hydrogen atoms added and optimized by MolProbity. The Clashes column lists the number of clashes within the asymmetric unit, whereas Symm-Clashes lists symmetry-related clashes.

Mol	Chain	Non-H	H(model)	H(added)	Clashes	Symm-Clashes
1	I	2990	0	1651	99	0
1	J	2990	0	1651	106	0
2	A	816	0	854	34	0
2	E	867	0	910	23	0
3	B	666	0	706	21	0
3	F	730	0	784	25	0
4	C	834	0	894	30	0
4	G	828	0	890	27	0
5	D	828	0	862	34	0
5	H	792	0	822	19	0
6	E	1	0	0	0	0
6	I	7	0	0	0	0
6	J	6	0	0	0	0
7	I	34	0	18	19	0
8	I	108	0	72	55	0
9	I	12	0	0	15	0
10	I	10	0	10	0	0
11	I	14	0	26	16	0
12	J	12	0	10	10	0
13	A	1	0	0	1	0
13	D	1	0	0	0	0
13	E	1	0	0	0	0
13	G	1	0	0	1	0
14	A	77	0	0	8	0
14	B	53	0	0	3	0
14	C	109	0	0	7	0
14	D	62	0	0	6	0
14	E	97	0	0	5	0
14	F	85	0	0	3	0
14	G	80	0	0	2	0
14	H	29	0	0	0	0
14	I	145	0	0	9	0
14	J	151	0	0	5	0
All	All	13437	0	10160	421	0

The all-atom clashscore is defined as the number of clashes found per 1000 atoms (including hydrogen atoms). The all-atom clashscore for this structure is 19.

The worst 5 of 421 close contacts within the same asymmetric unit are listed below, sorted by their clash magnitude.

Atom-1	Atom-2	Interatomic distance (Å)	Clash overlap (Å)
12:J:1700:OGG:OH	12:J:1700:OGG:CG	1.65	1.44

Continued on next page...

Continued from previous page...

Atom-1	Atom-2	Interatomic distance (Å)	Clash overlap (Å)
12:J:1700:OGG:OH	12:J:1700:OGG:CI	1.70	1.39
12:J:1700:OGG:CD	12:J:1700:OGG:OE	1.80	1.29
1:I:133:DA:H2''	1:I:134:DG:H5''	1.36	1.07
1:J:261:DA:H2''	1:J:262:DC:H5''	1.38	1.05

There are no symmetry-related clashes.

5.3 Torsion angles [i](#)

5.3.1 Protein backbone [i](#)

In the following table, the Percentiles column shows the percent Ramachandran outliers of the chain as a percentile score with respect to all X-ray entries followed by that with respect to entries of similar resolution.

The Analysed column shows the number of residues for which the backbone conformation was analysed, and the total number of residues.

Mol	Chain	Analysed	Favoured	Allowed	Outliers	Percentiles	
2	A	97/135 (72%)	97 (100%)	0	0	100	100
2	E	102/135 (76%)	101 (99%)	0	1 (1%)	15	6
3	B	81/102 (79%)	78 (96%)	1 (1%)	2 (2%)	5	1
3	F	88/102 (86%)	82 (93%)	6 (7%)	0	100	100
4	C	106/119 (89%)	102 (96%)	4 (4%)	0	100	100
4	G	105/119 (88%)	103 (98%)	2 (2%)	0	100	100
5	D	102/122 (84%)	97 (95%)	1 (1%)	4 (4%)	3	0
5	H	98/122 (80%)	92 (94%)	3 (3%)	3 (3%)	4	0
All	All	779/956 (82%)	752 (96%)	17 (2%)	10 (1%)	12	4

5 of 10 Ramachandran outliers are listed below:

Mol	Chain	Res	Type
3	B	23	ARG
3	B	25	ASN
5	D	1224	LYS
5	D	1227	ARG
5	D	1301	GLY

5.3.2 Protein sidechains [i](#)

In the following table, the Percentiles column shows the percent sidechain outliers of the chain as a percentile score with respect to all X-ray entries followed by that with respect to entries of similar resolution.

The Analysed column shows the number of residues for which the sidechain conformation was analysed, and the total number of residues.

Mol	Chain	Analysed	Rotameric	Outliers	Percentiles	
2	A	86/110 (78%)	80 (93%)	6 (7%)	15	7
2	E	91/110 (83%)	90 (99%)	1 (1%)	73	73
3	B	68/78 (87%)	64 (94%)	4 (6%)	19	11
3	F	74/78 (95%)	73 (99%)	1 (1%)	67	65
4	C	85/92 (92%)	82 (96%)	3 (4%)	36	29
4	G	85/92 (92%)	82 (96%)	3 (4%)	36	29
5	D	89/102 (87%)	89 (100%)	0	100	100
5	H	86/102 (84%)	82 (95%)	4 (5%)	26	18
All	All	664/764 (87%)	642 (97%)	22 (3%)	40	31

5 of 22 residues with a non-rotameric sidechain are listed below:

Mol	Chain	Res	Type
3	F	216	LYS
4	G	1119	LYS
4	G	1081	ARG
5	H	1426	ARG
3	B	22	LEU

Sometimes sidechains can be flipped to improve hydrogen bonding and reduce clashes. All (5) such sidechains are listed below:

Mol	Chain	Res	Type
2	A	439	HIS
4	C	831	HIS
5	D	1279	HIS
4	G	1031	HIS
5	H	1492	GLN

5.3.3 RNA [i](#)

There are no RNA molecules in this entry.

5.4 Non-standard residues in protein, DNA, RNA chains [i](#)

There are no non-standard protein/DNA/RNA residues in this entry.

5.5 Carbohydrates [i](#)

There are no monosaccharides in this entry.

5.6 Ligand geometry [i](#)

Of 41 ligands modelled in this entry, 18 are monoatomic - leaving 23 for Mogul analysis.

In the following table, the Counts columns list the number of bonds (or angles) for which Mogul statistics could be retrieved, the number of bonds (or angles) that are observed in the model and the number of bonds (or angles) that are defined in the Chemical Component Dictionary. The Link column lists molecule types, if any, to which the group is linked. The Z score for a bond length (or angle) is the number of standard deviations the observed value is removed from the expected value. A bond length (or angle) with $|Z| > 2$ is considered an outlier worth inspection. RMSZ is the root-mean-square of all Z scores of the bond lengths (or angles).

Mol	Type	Chain	Res	Link	Bond lengths			Bond angles		
					Counts	RMSZ	# Z > 2	Counts	RMSZ	# Z > 2
8	PYB	I	1609	-	7,9,10	1.03	1 (14%)	3,12,14	4.17	2 (66%)
7	IMT	I	1601	-	7,8,10	0.97	1 (14%)	5,10,14	2.30	3 (60%)
8	PYB	I	1602	-	7,9,10	1.25	2 (28%)	3,12,14	3.33	2 (66%)
7	IMT	I	1603	-	5,9,10	1.05	0	5,12,14	2.24	2 (40%)
8	PYB	I	1626	-	7,9,10	1.92	3 (42%)	3,12,14	3.04	2 (66%)
12	OGG	J	1700	-	11,11,11	6.61	8 (72%)	12,12,12	2.30	3 (25%)
8	PYB	I	1627	-	7,9,10	1.08	0	3,12,14	4.00	2 (66%)
8	PYB	I	1606	-	7,9,10	3.78	3 (42%)	3,12,14	4.28	2 (66%)
8	PYB	I	1604	-	7,9,10	1.02	0	3,12,14	3.63	2 (66%)
9	ABU	I	1625	-	5,5,6	1.50	1 (20%)	4,4,6	1.90	1 (25%)
8	PYB	I	1629	-	7,9,10	1.05	1 (14%)	3,12,14	4.00	2 (66%)
7	IMT	I	1623	-	5,9,10	0.78	0	5,12,14	2.15	2 (40%)
7	IMT	I	1621	-	7,8,10	0.95	1 (14%)	5,10,14	2.28	3 (60%)
9	ABU	I	1605	-	5,5,6	2.47	3 (60%)	4,4,6	1.37	1 (25%)
10	BAL	I	1610	-	4,4,5	0.57	0	3,3,5	1.65	1 (33%)
11	DIB	I	1611	-	6,6,6	0.63	0	6,6,6	0.88	0
8	PYB	I	1607	-	7,9,10	1.07	0	3,12,14	4.02	2 (66%)
11	DIB	I	1631	-	6,6,6	0.69	0	6,6,6	0.83	0

Mol	Type	Chain	Res	Link	Bond lengths			Bond angles		
					Counts	RMSZ	# Z > 2	Counts	RMSZ	# Z > 2
8	PYB	I	1624	-	7,9,10	1.05	0	3,12,14	3.31	2 (66%)
8	PYB	I	1622	-	7,9,10	1.32	2 (28%)	3,12,14	3.43	2 (66%)
10	BAL	I	1630	-	4,4,5	0.47	0	3,3,5	0.82	0
8	PYB	I	1608	-	7,9,10	1.10	1 (14%)	3,12,14	4.89	2 (66%)
8	PYB	I	1628	-	7,9,10	1.18	1 (14%)	3,12,14	4.52	2 (66%)

In the following table, the Chirals column lists the number of chiral outliers, the number of chiral centers analysed, the number of these observed in the model and the number defined in the Chemical Component Dictionary. Similar counts are reported in the Torsion and Rings columns. '-' means no outliers of that kind were identified.

Mol	Type	Chain	Res	Link	Chirals	Torsions	Rings
8	PYB	I	1609	-	-	0/0/2/4	0/1/1/1
7	IMT	I	1601	-	-	0/0/2/4	0/1/1/1
8	PYB	I	1602	-	-	0/0/2/4	0/1/1/1
7	IMT	I	1603	-	-	0/0/2/4	0/1/1/1
8	PYB	I	1626	-	-	0/0/2/4	0/1/1/1
12	OGG	J	1700	-	-	5/9/9/9	-
8	PYB	I	1627	-	-	0/0/2/4	0/1/1/1
8	PYB	I	1606	-	-	0/0/2/4	0/1/1/1
8	PYB	I	1604	-	-	0/0/2/4	0/1/1/1
9	ABU	I	1625	-	-	3/3/3/4	-
8	PYB	I	1629	-	-	0/0/2/4	0/1/1/1
7	IMT	I	1623	-	-	0/0/2/4	0/1/1/1
7	IMT	I	1621	-	-	0/0/2/4	0/1/1/1
9	ABU	I	1605	-	-	3/3/3/4	-
10	BAL	I	1610	-	-	0/1/2/3	-
11	DIB	I	1611	-	-	0/4/4/4	-
8	PYB	I	1607	-	-	0/0/2/4	0/1/1/1
11	DIB	I	1631	-	-	0/4/4/4	-
8	PYB	I	1624	-	-	0/0/2/4	0/1/1/1
8	PYB	I	1622	-	-	0/0/2/4	0/1/1/1
10	BAL	I	1630	-	-	0/1/2/3	-
8	PYB	I	1608	-	-	0/0/2/4	0/1/1/1
8	PYB	I	1628	-	-	0/0/2/4	0/1/1/1

The worst 5 of 28 bond length outliers are listed below:

Mol	Chain	Res	Type	Atoms	Z	Observed(Å)	Ideal(Å)
12	J	1700	OGG	OE-CD	15.01	1.80	1.42
12	J	1700	OGG	OH-CI	11.25	1.70	1.42

Continued on next page...

Continued from previous page...

Mol	Chain	Res	Type	Atoms	Z	Observed(Å)	Ideal(Å)
8	I	1606	PYB	CB-CA	8.28	1.47	1.38
12	J	1700	OGG	CD-CC	5.88	1.62	1.50
12	J	1700	OGG	OH-CG	5.49	1.65	1.42

The worst 5 of 40 bond angle outliers are listed below:

Mol	Chain	Res	Type	Atoms	Z	Observed(°)	Ideal(°)
8	I	1608	PYB	CB1-CA-CB	6.67	109.31	106.05
8	I	1609	PYB	CB1-CA-CB	5.84	108.91	106.05
8	I	1628	PYB	CB1-CA-CB	5.82	108.90	106.05
8	I	1606	PYB	CB1-CA-CB	-5.72	103.25	106.05
8	I	1629	PYB	CB1-CA-CB	5.27	108.63	106.05

There are no chirality outliers.

5 of 11 torsion outliers are listed below:

Mol	Chain	Res	Type	Atoms
9	I	1605	ABU	CD-CB-CG-C
9	I	1625	ABU	CD-CB-CG-C
12	J	1700	OGG	OH-CI-CJ-NK
12	J	1700	OGG	OE-CF-CG-OH
9	I	1605	ABU	OXT-C-CG-CB

There are no ring outliers.

21 monomers are involved in 94 short contacts:

Mol	Chain	Res	Type	Clashes	Symm-Clashes
8	I	1609	PYB	3	0
7	I	1601	IMT	4	0
8	I	1602	PYB	5	0
7	I	1603	IMT	5	0
8	I	1626	PYB	8	0
12	J	1700	OGG	10	0
8	I	1627	PYB	5	0
8	I	1606	PYB	4	0
8	I	1604	PYB	7	0
9	I	1625	ABU	9	0
8	I	1629	PYB	6	0
7	I	1623	IMT	5	0
7	I	1621	IMT	5	0
9	I	1605	ABU	6	0

Continued on next page...

Continued from previous page...

Mol	Chain	Res	Type	Clashes	Symm-Clashes
11	I	1611	DIB	11	0
8	I	1607	PYB	6	0
11	I	1631	DIB	5	0
8	I	1624	PYB	6	0
8	I	1622	PYB	6	0
8	I	1608	PYB	5	0
8	I	1628	PYB	7	0

5.7 Other polymers [i](#)

There are no such residues in this entry.

5.8 Polymer linkage issues [i](#)

There are no chain breaks in this entry.

6 Fit of model and data [i](#)

6.1 Protein, DNA and RNA chains [i](#)

In the following table, the column labelled ‘#RSRZ > 2’ contains the number (and percentage) of RSRZ outliers, followed by percent RSRZ outliers for the chain as percentile scores relative to all X-ray entries and entries of similar resolution. The OWAB column contains the minimum, median, 95th percentile and maximum values of the occupancy-weighted average B-factor per residue. The column labelled ‘Q < 0.9’ lists the number of (and percentage) of residues with an average occupancy less than 0.9.

Mol	Chain	Analysed	<RSRZ>	#RSRZ>2	OWAB(Å ²)	Q<0.9
1	I	146/146 (100%)	0.35	3 (2%) 63 67	42, 97, 137, 157	0
1	J	146/146 (100%)	0.28	4 (2%) 54 59	46, 100, 145, 162	0
2	A	98/135 (72%)	0.62	3 (3%) 49 53	31, 44, 71, 93	0
2	E	99/135 (73%)	0.57	5 (5%) 28 30	26, 36, 61, 87	0
3	B	81/102 (79%)	0.60	4 (4%) 29 31	32, 42, 70, 115	0
3	F	88/102 (86%)	0.72	6 (6%) 17 18	26, 37, 81, 132	0
4	C	107/119 (89%)	0.67	5 (4%) 31 33	28, 41, 65, 93	0
4	G	107/119 (89%)	0.83	8 (7%) 14 15	35, 52, 77, 109	0
5	D	101/122 (82%)	0.95	9 (8%) 9 10	30, 43, 112, 138	0
5	H	98/122 (80%)	0.82	11 (11%) 5 5	34, 50, 105, 128	0
All	All	1071/1248 (85%)	0.62	58 (5%) 25 28	26, 50, 126, 162	0

The worst 5 of 58 RSRZ outliers are listed below:

Mol	Chain	Res	Type	RSRZ
4	C	813	LYS	11.2
3	B	102	GLY	10.0
4	C	812	ALA	9.2
2	A	535	ALA	9.1
5	D	1222	ASP	8.6

6.2 Non-standard residues in protein, DNA, RNA chains [i](#)

There are no non-standard protein/DNA/RNA residues in this entry.

6.3 Carbohydrates [i](#)

There are no monosaccharides in this entry.

6.4 Ligands [i](#)

In the following table, the Atoms column lists the number of modelled atoms in the group and the number defined in the chemical component dictionary. The B-factors column lists the minimum, median, 95th percentile and maximum values of B factors of atoms in the group. The column labelled 'Q< 0.9' lists the number of atoms with occupancy less than 0.9.

Mol	Type	Chain	Res	Atoms	RSCC	RSR	B-factors(Å ²)	Q<0.9
9	ABU	I	1625	6/7	0.13	0.39	137,139,141,143	0
12	OGG	J	1700	12/12	0.26	0.25	111,119,129,130	0
11	DIB	I	1611	7/7	0.39	0.42	142,142,142,142	0
9	ABU	I	1605	6/7	0.46	0.21	136,138,141,144	0
6	MN	I	2007	1/1	0.59	0.12	89,89,89,89	1
6	MN	I	2009	1/1	0.64	0.19	106,106,106,106	1
10	BAL	I	1630	5/6	0.64	0.39	143,143,143,143	0
8	PYB	I	1626	9/10	0.69	0.22	141,144,146,146	0
6	MN	J	2010	1/1	0.69	0.20	104,104,104,104	1
6	MN	I	2014	1/1	0.70	0.15	107,107,107,107	1
6	MN	J	2011	1/1	0.70	0.18	93,93,93,93	1
8	PYB	I	1604	9/10	0.70	0.27	146,148,148,148	0
11	DIB	I	1631	7/7	0.72	0.56	142,143,143,143	0
6	MN	I	2006	1/1	0.72	0.10	101,101,101,101	1
8	PYB	I	1606	9/10	0.74	0.21	140,143,145,146	0
10	BAL	I	1610	5/6	0.76	0.30	141,142,142,143	0
8	PYB	I	1609	9/10	0.78	0.26	143,144,144,144	0
6	MN	J	2008	1/1	0.78	0.15	109,109,109,109	1
7	IMT	I	1603	9/10	0.78	0.26	148,148,148,148	0
6	MN	J	2013	1/1	0.81	0.09	90,90,90,90	1
8	PYB	I	1624	9/10	0.81	0.23	144,146,146,146	0
7	IMT	I	1621	8/10	0.82	0.28	147,147,148,148	0
6	MN	J	2005	1/1	0.83	0.14	77,77,77,77	0
8	PYB	I	1608	9/10	0.83	0.34	144,144,145,145	0
8	PYB	I	1607	9/10	0.84	0.23	145,145,145,145	0
7	IMT	I	1623	9/10	0.85	0.20	146,146,147,147	0
8	PYB	I	1629	9/10	0.85	0.21	143,144,144,144	0
8	PYB	I	1602	9/10	0.85	0.24	148,148,149,149	0
7	IMT	I	1601	8/10	0.86	0.36	149,149,149,149	0
8	PYB	I	1622	9/10	0.86	0.30	147,147,147,148	0
8	PYB	I	1628	9/10	0.88	0.29	144,144,145,145	0
8	PYB	I	1627	9/10	0.90	0.21	145,145,145,145	0

Continued on next page...

Continued from previous page...

Mol	Type	Chain	Res	Atoms	RSCC	RSR	B-factors(\AA^2)	Q<0.9
6	MN	I	2003	1/1	0.94	0.18	83,83,83,83	0
6	MN	J	2002	1/1	0.94	0.11	72,72,72,72	1
6	MN	I	2004	1/1	0.95	0.18	77,77,77,77	1
13	CL	D	2018	1/1	0.95	0.18	50,50,50,50	0
13	CL	G	2016	1/1	0.95	0.17	54,54,54,54	0
6	MN	I	2012	1/1	0.96	0.07	60,60,60,60	1
13	CL	E	2015	1/1	0.97	0.17	48,48,48,48	1
13	CL	A	2017	1/1	0.98	0.15	56,56,56,56	0
6	MN	E	2001	1/1	1.00	0.13	34,34,34,34	0

6.5 Other polymers [i](#)

There are no such residues in this entry.