



# wwPDB X-ray Structure Validation Summary Report ⓘ

Feb 17, 2024 – 09:15 AM EST

PDB ID : 3RWR  
Title : Crystal structure of the human XRCC4-XLF complex  
Authors : Andres, S.N.; Junop, M.S.  
Deposited on : 2011-05-09  
Resolution : 3.94 Å(reported)

This is a wwPDB X-ray Structure Validation Summary Report for a publicly released PDB entry.

We welcome your comments at [validation@mail.wwpdb.org](mailto:validation@mail.wwpdb.org)

A user guide is available at

<https://www.wwpdb.org/validation/2017/XrayValidationReportHelp>

with specific help available everywhere you see the ⓘ symbol.

The types of validation reports are described at

<https://www.wwpdb.org/validation/2017/FAQs#types>.

---

The following versions of software and data (see [references ⓘ](#)) were used in the production of this report:

MolProbity : 4.02b-467  
Mogul : 1.8.5 (274361), CSD as541be (2020)  
Xtriage (Phenix) : 1.13  
EDS : 2.36  
buster-report : 1.1.7 (2018)  
Percentile statistics : 20191225.v01 (using entries in the PDB archive December 25th 2019)  
Refmac : 5.8.0158  
CCP4 : 7.0.044 (Gargrove)  
Ideal geometry (proteins) : Engh & Huber (2001)  
Ideal geometry (DNA, RNA) : Parkinson et al. (1996)  
Validation Pipeline (wwPDB-VP) : 2.36

# 1 Overall quality at a glance

The following experimental techniques were used to determine the structure:

*X-RAY DIFFRACTION*

The reported resolution of this entry is 3.94 Å.

Percentile scores (ranging between 0-100) for global validation metrics of the entry are shown in the following graphic. The table shows the number of entries on which the scores are based.

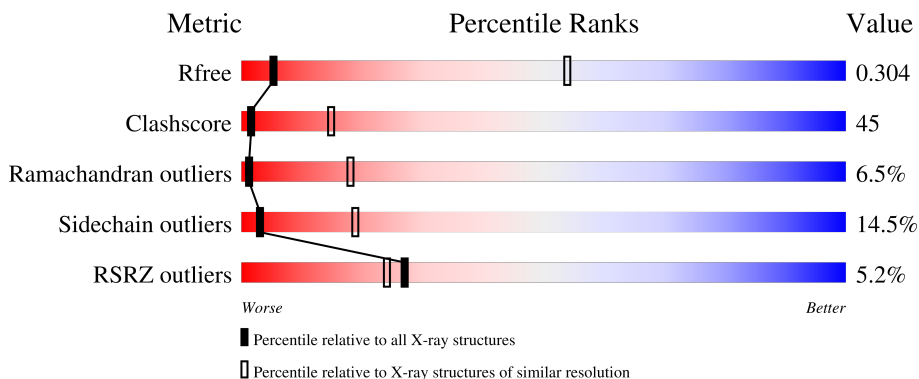

Metric	Whole archive (#Entries)	Similar resolution (#Entries, resolution range(Å))
$R_{free}$	130704	1036 (4.20-3.68)
Clashscore	141614	1009 (4.18-3.70)
Ramachandran outliers	138981	1057 (4.20-3.68)
Sidechain outliers	138945	1049 (4.20-3.68)
RSRZ outliers	127900	1007 (4.24-3.64)

The table below summarises the geometric issues observed across the polymeric chains and their fit to the electron density. The red, orange, yellow and green segments of the lower bar indicate the fraction of residues that contain outliers for  $\geq 3$ , 2, 1 and 0 types of geometric quality criteria respectively. A grey segment represents the fraction of residues that are not modelled. The numeric value for each fraction is indicated below the corresponding segment, with a dot representing fractions  $\leq 5\%$ . The upper red bar (where present) indicates the fraction of residues that have poor fit to the electron density. The numeric value is given above the bar.

Mol	Chain	Length	Quality of chain
1	A	163	
1	B	163	
1	F	163	
1	G	163	
1	J	163	

*Continued on next page...*

Continued from previous page...

Mol	Chain	Length	Quality of chain
1	K	163	
1	N	163	
1	P	163	
1	R	163	
1	U	163	
1	V	163	
1	Y	163	
2	D	230	
2	E	230	
2	H	230	
2	I	230	
2	L	230	
2	M	230	
2	O	230	
2	Q	230	
2	S	230	
2	T	230	
2	W	230	
2	X	230	

The following table lists non-polymeric compounds, carbohydrate monomers and non-standard residues in protein, DNA, RNA chains that are outliers for geometric or electron-density-fit criteria:

Mol	Type	Chain	Res	Chirality	Geometry	Clashes	Electron density
3	TBR	D	231	-	-	-	X
3	TBR	J	164	-	-	X	X
3	TBR	M	164	-	-	-	X
3	TBR	P	2	-	-	X	-
3	TBR	X	5	-	-	X	X

## 2 Entry composition [i](#)

There are 3 unique types of molecules in this entry. The entry contains 36833 atoms, of which 0 are hydrogens and 0 are deuteriums.

In the tables below, the ZeroOcc column contains the number of atoms modelled with zero occupancy, the AltConf column contains the number of residues with at least one atom in alternate conformation and the Trace column contains the number of residues modelled with at most 2 atoms.

- Molecule 1 is a protein called DNA repair protein XRCC4.

Mol	Chain	Residues	Atoms					ZeroOcc	AltConf	Trace
			Total	C	N	O	S			
1	A	147	1171	741	193	231	6	0	0	0
1	B	152	1239	782	207	244	6	0	0	0
1	F	157	1264	797	212	249	6	0	0	0
1	G	157	1264	797	212	249	6	0	0	0
1	J	157	1264	797	212	249	6	0	0	0
1	K	157	1264	797	212	249	6	0	0	0
1	N	157	1264	797	212	249	6	0	0	0
1	P	157	1264	797	212	249	6	0	0	0
1	R	157	1264	797	212	249	6	0	0	0
1	V	157	1264	797	212	249	6	0	0	0
1	U	157	1264	797	212	249	6	0	0	0
1	Y	157	1264	797	212	249	6	0	0	0

There are 72 discrepancies between the modelled and reference sequences:

Chain	Residue	Modelled	Actual	Comment	Reference
A	158	HIS	-	expression tag	UNP Q13426
A	159	HIS	-	expression tag	UNP Q13426
A	160	HIS	-	expression tag	UNP Q13426
A	161	HIS	-	expression tag	UNP Q13426
A	162	HIS	-	expression tag	UNP Q13426

*Continued on next page...*

*Continued from previous page...*

Chain	Residue	Modelled	Actual	Comment	Reference
A	163	HIS	-	expression tag	UNP Q13426
B	658	HIS	-	expression tag	UNP Q13426
B	659	HIS	-	expression tag	UNP Q13426
B	660	HIS	-	expression tag	UNP Q13426
B	661	HIS	-	expression tag	UNP Q13426
B	662	HIS	-	expression tag	UNP Q13426
B	663	HIS	-	expression tag	UNP Q13426
F	158	HIS	-	expression tag	UNP Q13426
F	159	HIS	-	expression tag	UNP Q13426
F	160	HIS	-	expression tag	UNP Q13426
F	161	HIS	-	expression tag	UNP Q13426
F	162	HIS	-	expression tag	UNP Q13426
F	163	HIS	-	expression tag	UNP Q13426
G	658	HIS	-	expression tag	UNP Q13426
G	659	HIS	-	expression tag	UNP Q13426
G	660	HIS	-	expression tag	UNP Q13426
G	661	HIS	-	expression tag	UNP Q13426
G	662	HIS	-	expression tag	UNP Q13426
G	663	HIS	-	expression tag	UNP Q13426
J	158	HIS	-	expression tag	UNP Q13426
J	159	HIS	-	expression tag	UNP Q13426
J	160	HIS	-	expression tag	UNP Q13426
J	161	HIS	-	expression tag	UNP Q13426
J	162	HIS	-	expression tag	UNP Q13426
J	163	HIS	-	expression tag	UNP Q13426
K	658	HIS	-	expression tag	UNP Q13426
K	659	HIS	-	expression tag	UNP Q13426
K	660	HIS	-	expression tag	UNP Q13426
K	661	HIS	-	expression tag	UNP Q13426
K	662	HIS	-	expression tag	UNP Q13426
K	663	HIS	-	expression tag	UNP Q13426
N	158	HIS	-	expression tag	UNP Q13426
N	159	HIS	-	expression tag	UNP Q13426
N	160	HIS	-	expression tag	UNP Q13426
N	161	HIS	-	expression tag	UNP Q13426
N	162	HIS	-	expression tag	UNP Q13426
N	163	HIS	-	expression tag	UNP Q13426
P	658	HIS	-	expression tag	UNP Q13426
P	659	HIS	-	expression tag	UNP Q13426
P	660	HIS	-	expression tag	UNP Q13426
P	661	HIS	-	expression tag	UNP Q13426
P	662	HIS	-	expression tag	UNP Q13426

*Continued on next page...*

*Continued from previous page...*

Chain	Residue	Modelled	Actual	Comment	Reference
P	663	HIS	-	expression tag	UNP Q13426
R	158	HIS	-	expression tag	UNP Q13426
R	159	HIS	-	expression tag	UNP Q13426
R	160	HIS	-	expression tag	UNP Q13426
R	161	HIS	-	expression tag	UNP Q13426
R	162	HIS	-	expression tag	UNP Q13426
R	163	HIS	-	expression tag	UNP Q13426
V	658	HIS	-	expression tag	UNP Q13426
V	659	HIS	-	expression tag	UNP Q13426
V	660	HIS	-	expression tag	UNP Q13426
V	661	HIS	-	expression tag	UNP Q13426
V	662	HIS	-	expression tag	UNP Q13426
V	663	HIS	-	expression tag	UNP Q13426
U	158	HIS	-	expression tag	UNP Q13426
U	159	HIS	-	expression tag	UNP Q13426
U	160	HIS	-	expression tag	UNP Q13426
U	161	HIS	-	expression tag	UNP Q13426
U	162	HIS	-	expression tag	UNP Q13426
U	163	HIS	-	expression tag	UNP Q13426
Y	658	HIS	-	expression tag	UNP Q13426
Y	659	HIS	-	expression tag	UNP Q13426
Y	660	HIS	-	expression tag	UNP Q13426
Y	661	HIS	-	expression tag	UNP Q13426
Y	662	HIS	-	expression tag	UNP Q13426
Y	663	HIS	-	expression tag	UNP Q13426

- Molecule 2 is a protein called Non-homologous end-joining factor 1.

Mol	Chain	Residues	Atoms					ZeroOcc	AltConf	Trace
			Total	C	N	O	S			
2	D	227	1811	1156	307	333	15	0	0	0
2	E	227	1811	1156	307	333	15	0	0	0
2	H	227	1811	1156	307	333	15	0	0	0
2	I	227	1811	1156	307	333	15	0	0	0
2	L	227	1811	1156	307	333	15	0	0	0
2	M	227	1811	1156	307	333	15	0	0	0
2	O	227	1807	1153	306	333	15	0	0	0

*Continued on next page...*

Continued from previous page...

Mol	Chain	Residues	Atoms					ZeroOcc	AltConf	Trace
			Total	C	N	O	S			
2	Q	227	1811	1156	307	333	15	0	0	0
2	S	218	1744	1115	295	319	15	0	0	0
2	W	227	1811	1156	307	333	15	0	0	0
2	T	224	1789	1142	302	330	15	0	0	0
2	X	227	1811	1156	307	333	15	0	0	0

There are 72 discrepancies between the modelled and reference sequences:

Chain	Residue	Modelled	Actual	Comment	Reference
D	225	HIS	-	expression tag	UNP Q9H9Q4
D	226	HIS	-	expression tag	UNP Q9H9Q4
D	227	HIS	-	expression tag	UNP Q9H9Q4
D	228	HIS	-	expression tag	UNP Q9H9Q4
D	229	HIS	-	expression tag	UNP Q9H9Q4
D	230	HIS	-	expression tag	UNP Q9H9Q4
E	725	HIS	-	expression tag	UNP Q9H9Q4
E	726	HIS	-	expression tag	UNP Q9H9Q4
E	727	HIS	-	expression tag	UNP Q9H9Q4
E	728	HIS	-	expression tag	UNP Q9H9Q4
E	729	HIS	-	expression tag	UNP Q9H9Q4
E	730	HIS	-	expression tag	UNP Q9H9Q4
H	225	HIS	-	expression tag	UNP Q9H9Q4
H	226	HIS	-	expression tag	UNP Q9H9Q4
H	227	HIS	-	expression tag	UNP Q9H9Q4
H	228	HIS	-	expression tag	UNP Q9H9Q4
H	229	HIS	-	expression tag	UNP Q9H9Q4
H	230	HIS	-	expression tag	UNP Q9H9Q4
I	725	HIS	-	expression tag	UNP Q9H9Q4
I	726	HIS	-	expression tag	UNP Q9H9Q4
I	727	HIS	-	expression tag	UNP Q9H9Q4
I	728	HIS	-	expression tag	UNP Q9H9Q4
I	729	HIS	-	expression tag	UNP Q9H9Q4
I	730	HIS	-	expression tag	UNP Q9H9Q4
L	225	HIS	-	expression tag	UNP Q9H9Q4
L	226	HIS	-	expression tag	UNP Q9H9Q4
L	227	HIS	-	expression tag	UNP Q9H9Q4
L	228	HIS	-	expression tag	UNP Q9H9Q4
L	229	HIS	-	expression tag	UNP Q9H9Q4

Continued on next page...

*Continued from previous page...*

Chain	Residue	Modelled	Actual	Comment	Reference
L	230	HIS	-	expression tag	UNP Q9H9Q4
M	725	HIS	-	expression tag	UNP Q9H9Q4
M	726	HIS	-	expression tag	UNP Q9H9Q4
M	727	HIS	-	expression tag	UNP Q9H9Q4
M	728	HIS	-	expression tag	UNP Q9H9Q4
M	729	HIS	-	expression tag	UNP Q9H9Q4
M	730	HIS	-	expression tag	UNP Q9H9Q4
O	225	HIS	-	expression tag	UNP Q9H9Q4
O	226	HIS	-	expression tag	UNP Q9H9Q4
O	227	HIS	-	expression tag	UNP Q9H9Q4
O	228	HIS	-	expression tag	UNP Q9H9Q4
O	229	HIS	-	expression tag	UNP Q9H9Q4
O	230	HIS	-	expression tag	UNP Q9H9Q4
Q	725	HIS	-	expression tag	UNP Q9H9Q4
Q	726	HIS	-	expression tag	UNP Q9H9Q4
Q	727	HIS	-	expression tag	UNP Q9H9Q4
Q	728	HIS	-	expression tag	UNP Q9H9Q4
Q	729	HIS	-	expression tag	UNP Q9H9Q4
Q	730	HIS	-	expression tag	UNP Q9H9Q4
S	225	HIS	-	expression tag	UNP Q9H9Q4
S	226	HIS	-	expression tag	UNP Q9H9Q4
S	227	HIS	-	expression tag	UNP Q9H9Q4
S	228	HIS	-	expression tag	UNP Q9H9Q4
S	229	HIS	-	expression tag	UNP Q9H9Q4
S	230	HIS	-	expression tag	UNP Q9H9Q4
W	725	HIS	-	expression tag	UNP Q9H9Q4
W	726	HIS	-	expression tag	UNP Q9H9Q4
W	727	HIS	-	expression tag	UNP Q9H9Q4
W	728	HIS	-	expression tag	UNP Q9H9Q4
W	729	HIS	-	expression tag	UNP Q9H9Q4
W	730	HIS	-	expression tag	UNP Q9H9Q4
T	225	HIS	-	expression tag	UNP Q9H9Q4
T	226	HIS	-	expression tag	UNP Q9H9Q4
T	227	HIS	-	expression tag	UNP Q9H9Q4
T	228	HIS	-	expression tag	UNP Q9H9Q4
T	229	HIS	-	expression tag	UNP Q9H9Q4
T	230	HIS	-	expression tag	UNP Q9H9Q4
X	725	HIS	-	expression tag	UNP Q9H9Q4
X	726	HIS	-	expression tag	UNP Q9H9Q4
X	727	HIS	-	expression tag	UNP Q9H9Q4
X	728	HIS	-	expression tag	UNP Q9H9Q4
X	729	HIS	-	expression tag	UNP Q9H9Q4

*Continued on next page...*



Continued from previous page...

Chain	Residue	Modelled	Actual	Comment	Reference
X	730	HIS	-	expression tag	UNP Q9H9Q4

- Molecule 3 is HEXATANTALUM DODECABROMIDE (three-letter code: TBR) (formula:  $\text{Br}_{12}\text{Ta}_6$ ).

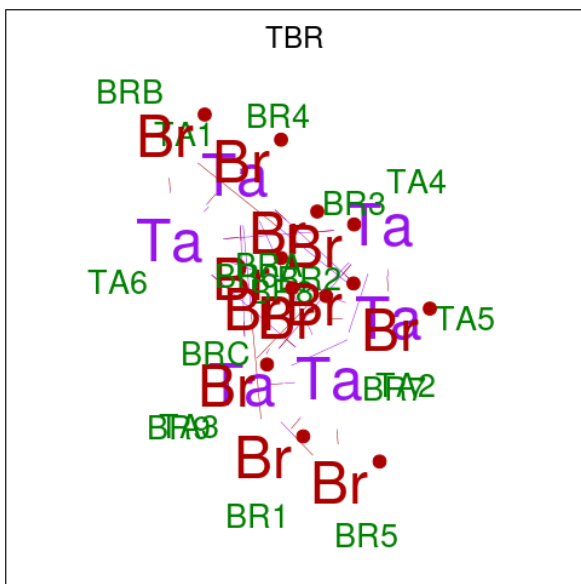

Mol	Chain	Residues	Atoms			ZeroOcc	AltConf
3	D	1	Total	Br	Ta	0	0
			18	12	6		
3	H	1	Total	Br	Ta	0	0
			18	12	6		
3	J	1	Total	Br	Ta	0	0
			18	12	6		
3	M	1	Total	Br	Ta	0	0
			18	12	6		
3	P	1	Total	Br	Ta	0	0
			18	12	6		
3	V	1	Total	Br	Ta	0	0
			18	12	6		
3	X	1	Total	Br	Ta	0	0
			18	12	6		
3	Y	1	Total	Br	Ta	0	0
			18	12	6		

### 3 Residue-property plots [i](#)

These plots are drawn for all protein, RNA, DNA and oligosaccharide chains in the entry. The first graphic for a chain summarises the proportions of the various outlier classes displayed in the second graphic. The second graphic shows the sequence view annotated by issues in geometry and electron density. Residues are color-coded according to the number of geometric quality criteria for which they contain at least one outlier: green = 0, yellow = 1, orange = 2 and red = 3 or more. A red dot above a residue indicates a poor fit to the electron density ( $RSRZ > 2$ ). Stretches of 2 or more consecutive residues without any outlier are shown as a green connector. Residues present in the sample, but not in the model, are shown in grey.

- Molecule 1: DNA repair protein XRCC4

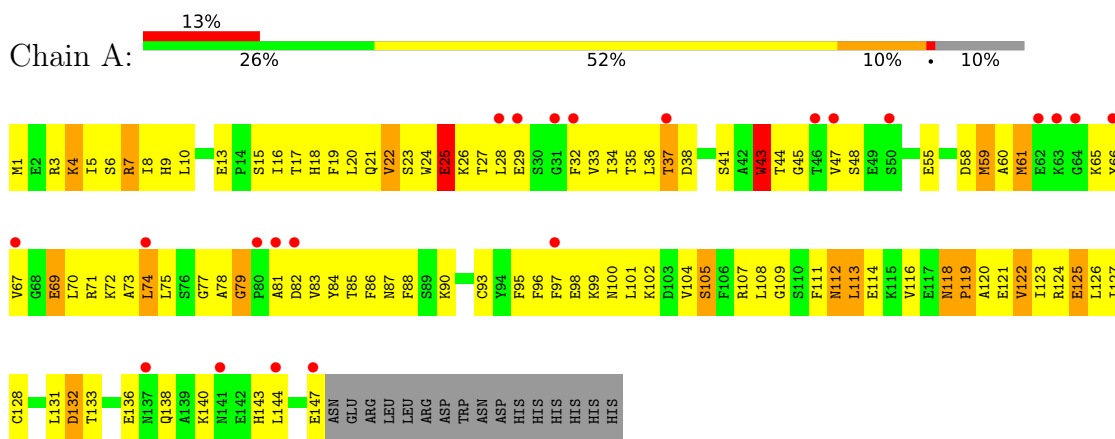

- Molecule 1: DNA repair protein XRCC4

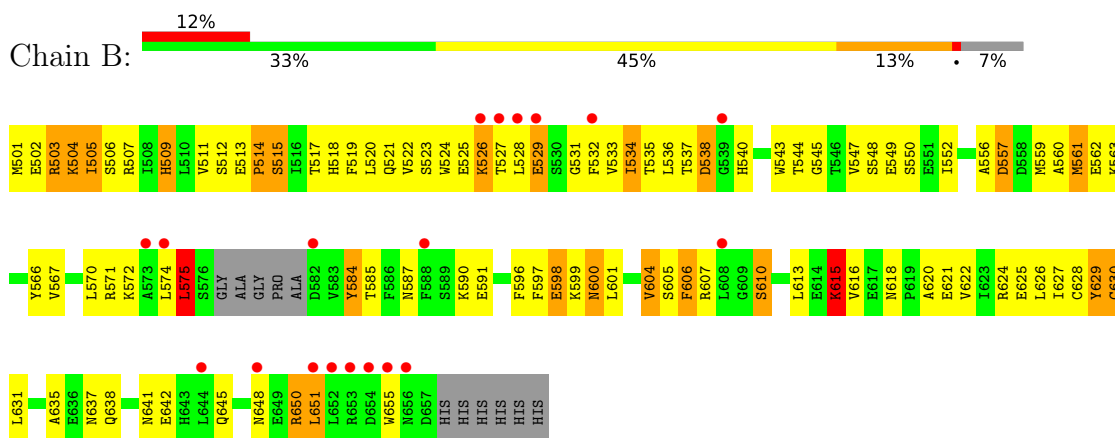

- Molecule 1: DNA repair protein XRCC4

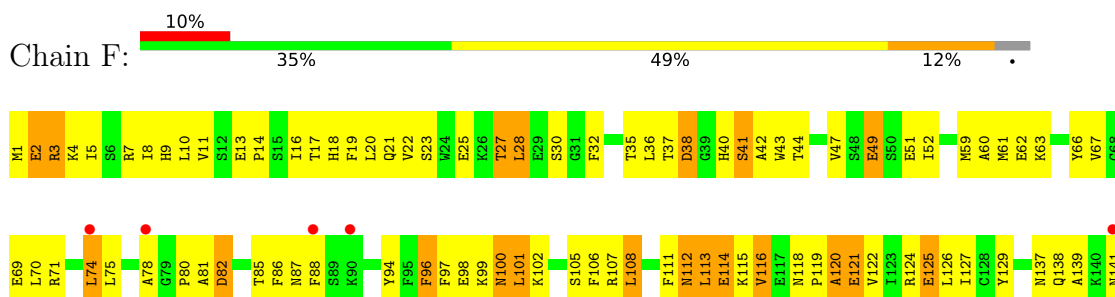

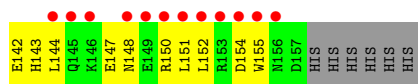

• Molecule 1: DNA repair protein XRCC4

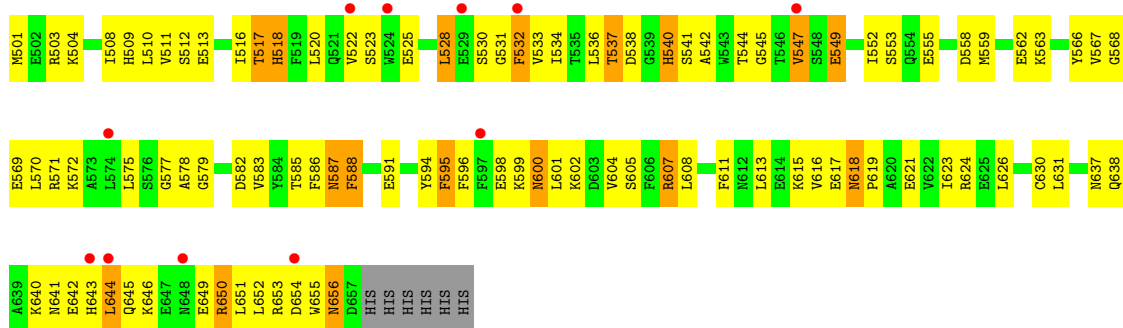

• Molecule 1: DNA repair protein XRCC4

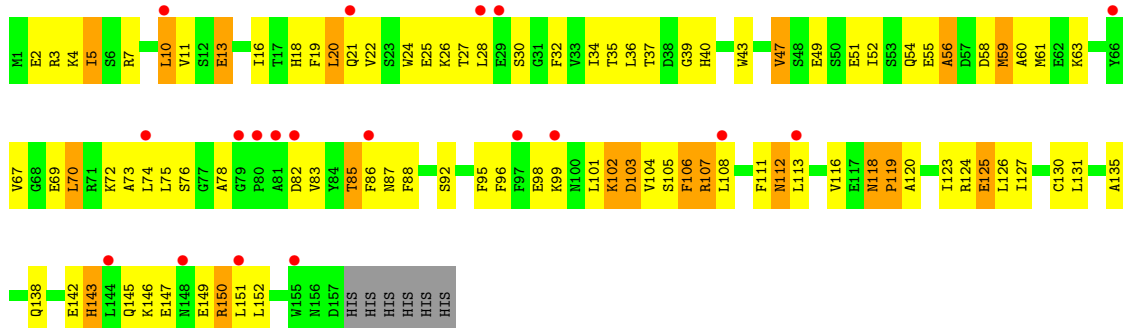

• Molecule 1: DNA repair protein XRCC4

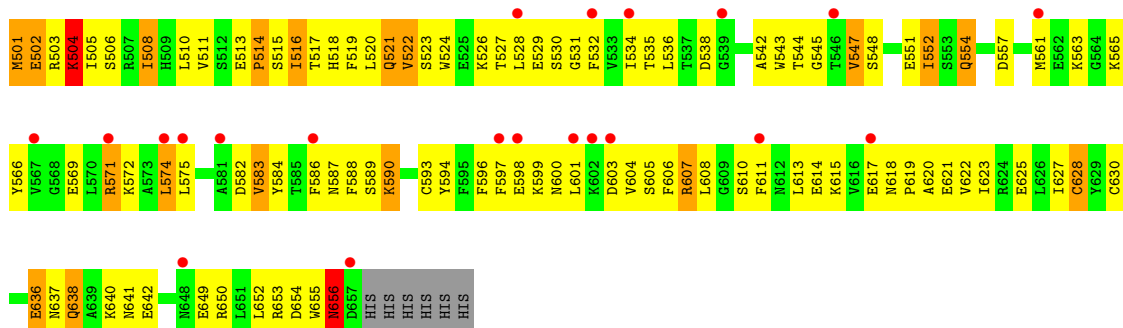

• Molecule 1: DNA repair protein XRCC4



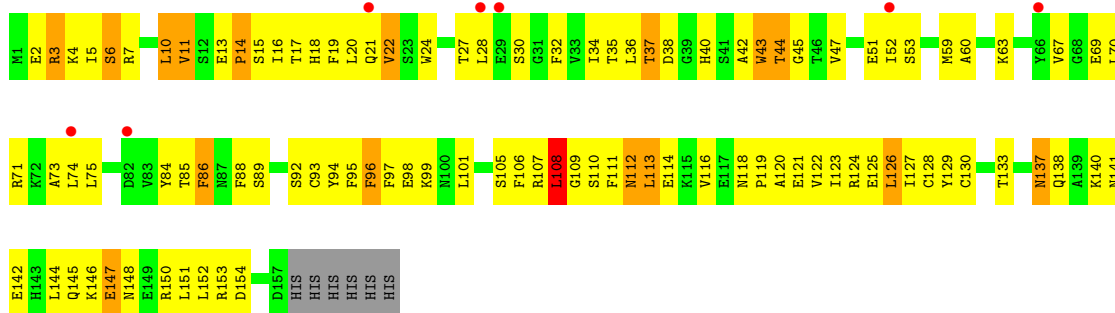

● Molecule 1: DNA repair protein XRCC4

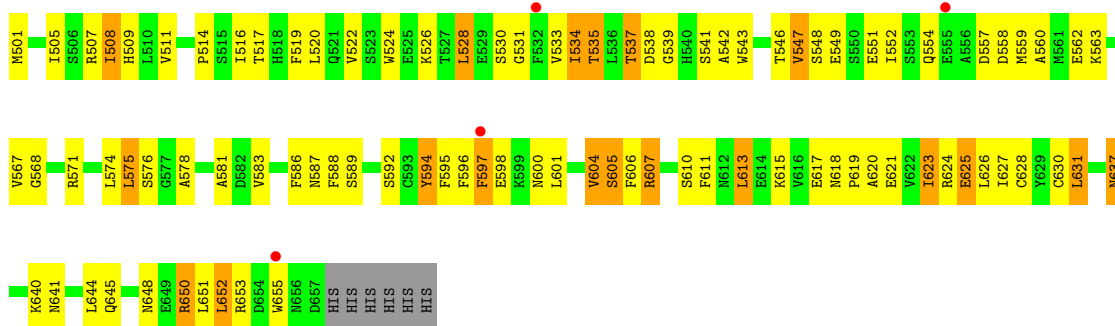

● Molecule 1: DNA repair protein XRCC4

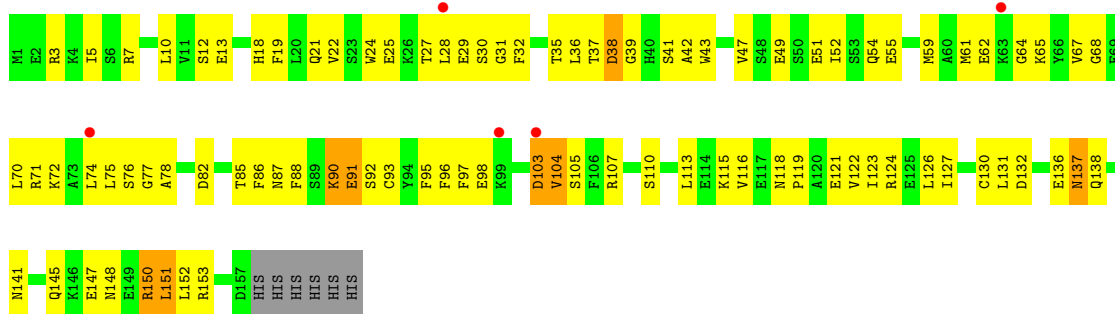
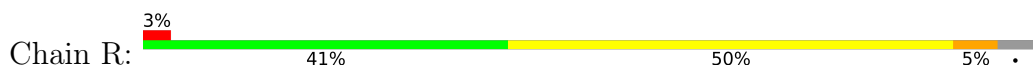

● Molecule 1: DNA repair protein XRCC4

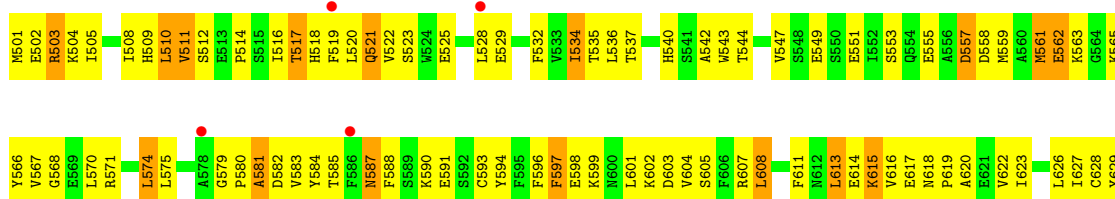



• Molecule 1: DNA repair protein XRCC4



• Molecule 1: DNA repair protein XRCC4

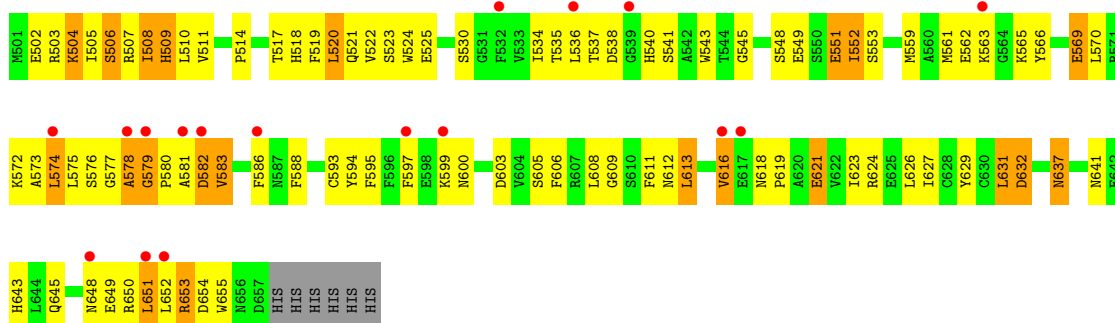

• Molecule 2: Non-homologous end-joining factor 1

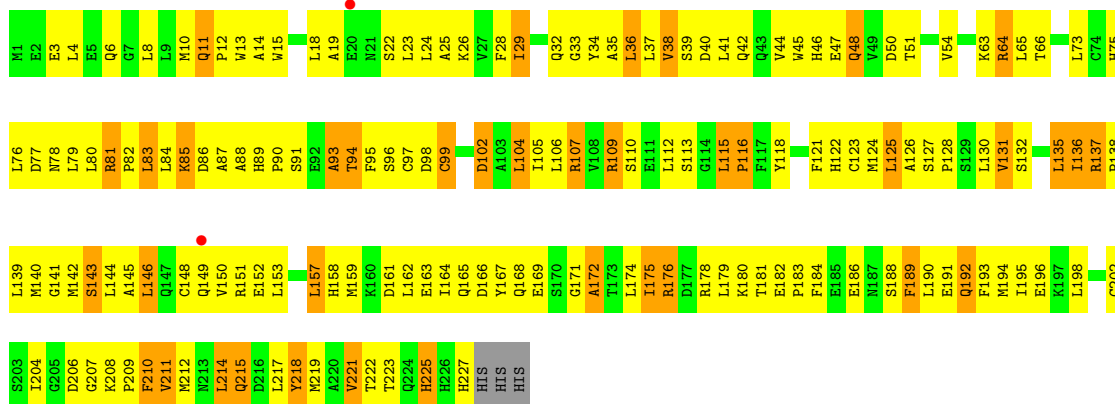

• Molecule 2: Non-homologous end-joining factor 1



- Molecule 2: Non-homologous end-joining factor 1

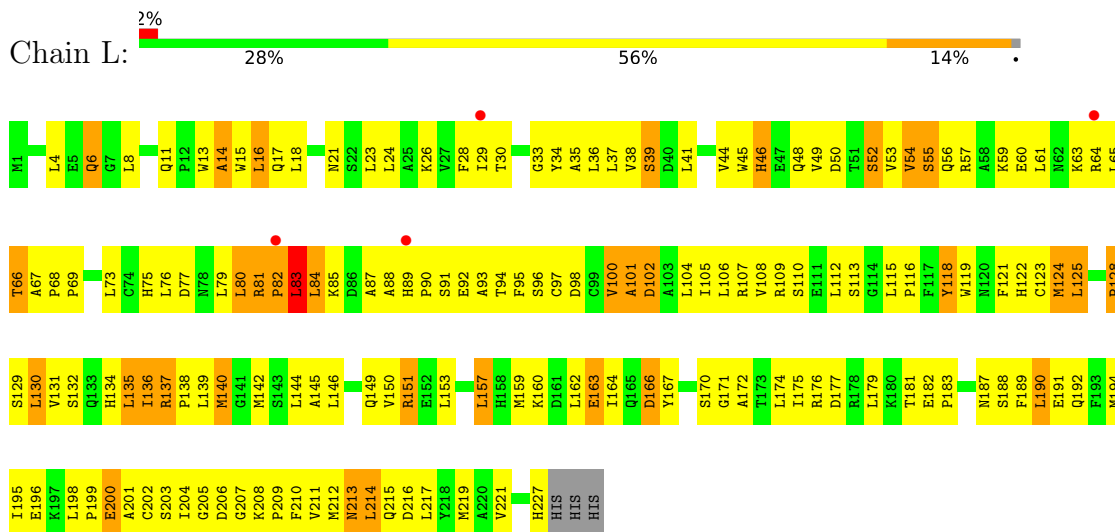

- Molecule 2: Non-homologous end-joining factor 1

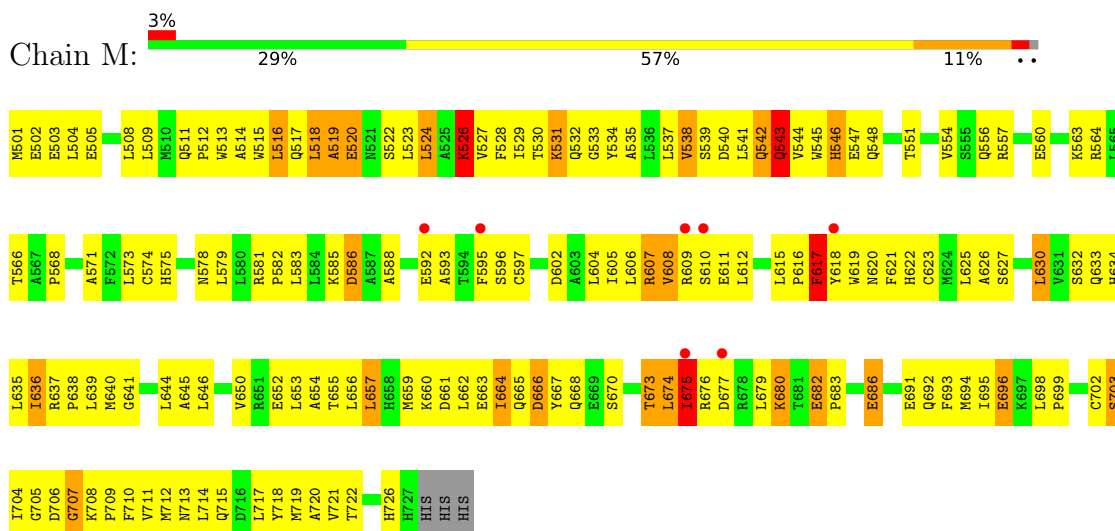

- Molecule 2: Non-homologous end-joining factor 1

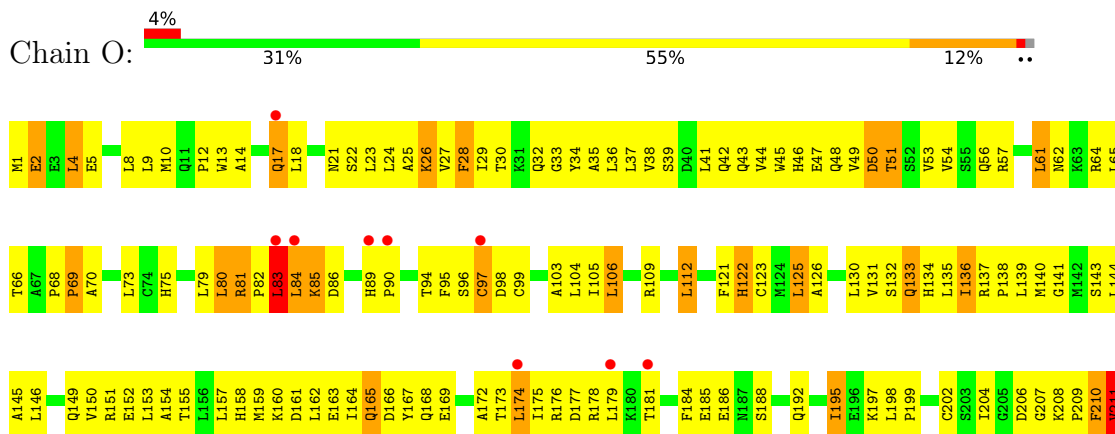

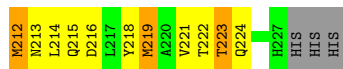

• Molecule 2: Non-homologous end-joining factor 1

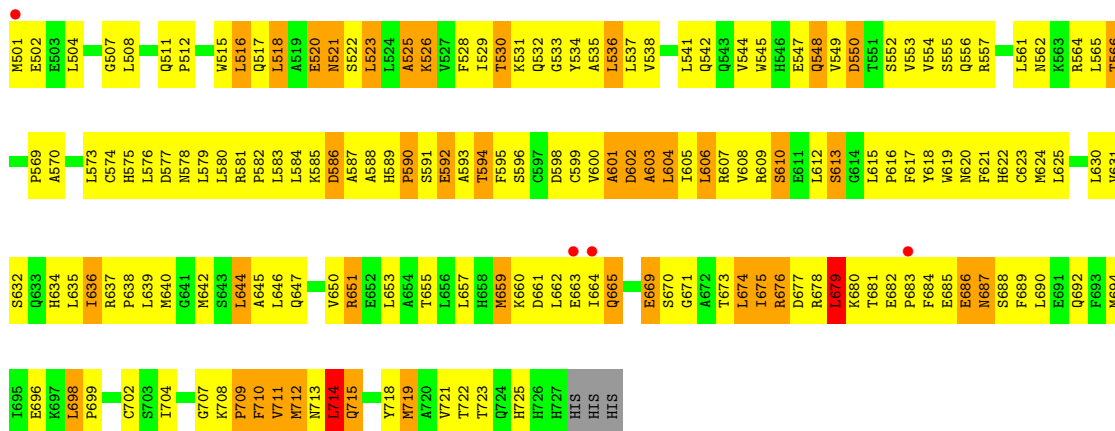

• Molecule 2: Non-homologous end-joining factor 1

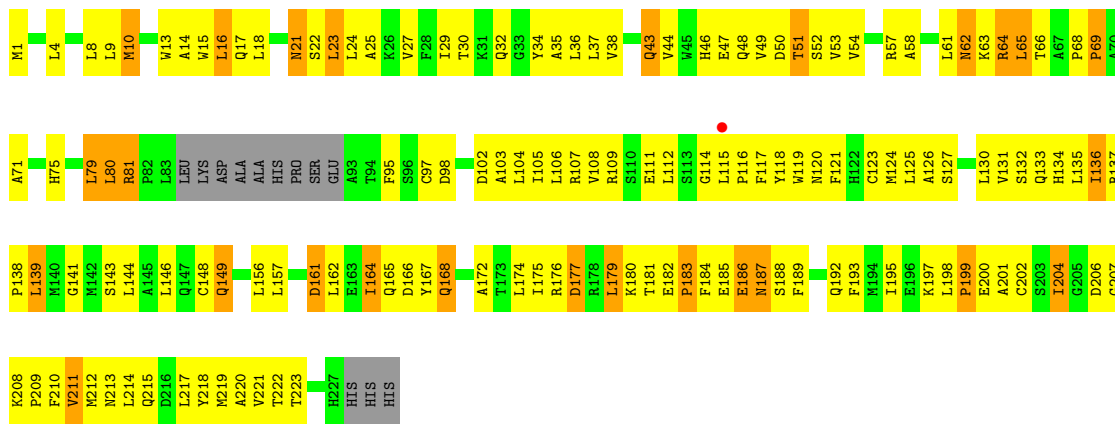
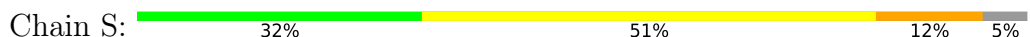

• Molecule 2: Non-homologous end-joining factor 1

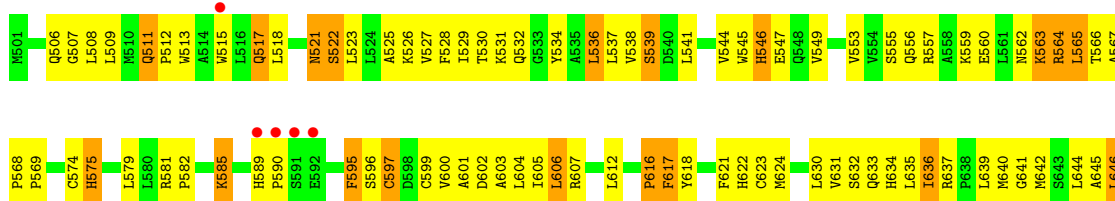



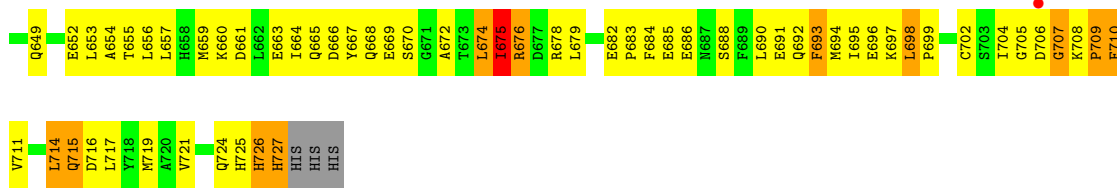

• Molecule 2: Non-homologous end-joining factor 1

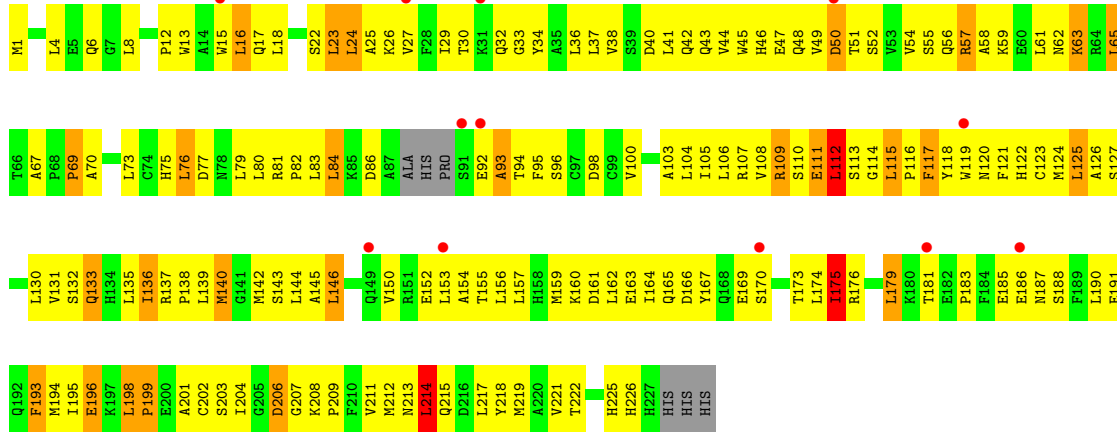

• Molecule 2: Non-homologous end-joining factor 1

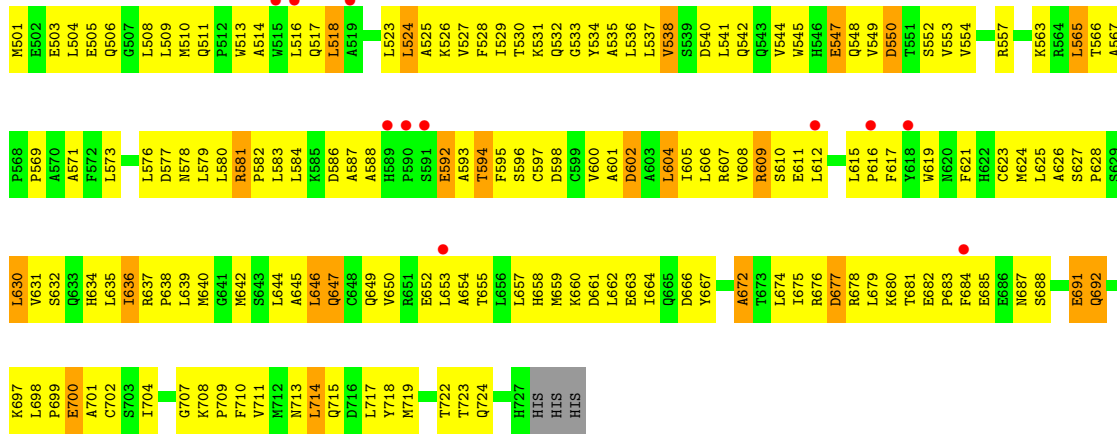

## 4 Data and refinement statistics i

Property	Value	Source
Space group	C 1 2 1	Depositor
Cell constants a, b, c, $\alpha$ , $\beta$ , $\gamma$	745.38Å 149.59Å 80.47Å 90.00° 94.72° 90.00°	Depositor
Resolution (Å)	49.03 – 3.94 49.03 – 3.94	Depositor EDS
% Data completeness (in resolution range)	99.1 (49.03-3.94) 99.2 (49.03-3.94)	Depositor EDS
$R_{merge}$	(Not available)	Depositor
$R_{sym}$	(Not available)	Depositor
$\langle I/\sigma(I) \rangle$ <sup>1</sup>	2.35 (at 4.00Å)	Xtrriage
Refinement program	PHENIX 1.7.2_869, CNS	Depositor
R, $R_{free}$	0.271 , 0.326 0.241 , 0.304	Depositor DCC
$R_{free}$ test set	3887 reflections (5.03%)	wwPDB-VP
Wilson B-factor (Å <sup>2</sup> )	135.1	Xtrriage
Anisotropy	0.618	Xtrriage
Bulk solvent $k_{sol}$ (e/Å <sup>3</sup> ), $B_{sol}$ (Å <sup>2</sup> )	0.28 , 130.7	EDS
L-test for twinning <sup>2</sup>	$\langle  L  \rangle = 0.43$ , $\langle L^2 \rangle = 0.26$	Xtrriage
Estimated twinning fraction	0.055 for -h-2*1,-k,l	Xtrriage
$F_o, F_c$ correlation	0.91	EDS
Total number of atoms	36833	wwPDB-VP
Average B, all atoms (Å <sup>2</sup> )	176.0	wwPDB-VP

Xtrriage's analysis on translational NCS is as follows: *The largest off-origin peak in the Patterson function is 8.44% of the height of the origin peak. No significant pseudotranslation is detected.*

<sup>1</sup>Intensities estimated from amplitudes.

<sup>2</sup>Theoretical values of  $\langle |L| \rangle$ ,  $\langle L^2 \rangle$  for acentric reflections are 0.5, 0.333 respectively for untwinned datasets, and 0.375, 0.2 for perfectly twinned datasets.

## 5 Model quality [i](#)

### 5.1 Standard geometry [i](#)

Bond lengths and bond angles in the following residue types are not validated in this section: TBR

The Z score for a bond length (or angle) is the number of standard deviations the observed value is removed from the expected value. A bond length (or angle) with  $|Z| > 5$  is considered an outlier worth inspection. RMSZ is the root-mean-square of all Z scores of the bond lengths (or angles).

Mol	Chain	Bond lengths		Bond angles	
		RMSZ	# Z  >5	RMSZ	# Z  >5
1	A	0.26	0/1194	0.44	0/1608
1	B	0.26	0/1262	0.44	0/1698
1	F	0.26	0/1289	0.44	0/1737
1	G	0.25	0/1289	0.42	0/1737
1	J	0.26	0/1289	0.42	0/1737
1	K	0.26	0/1289	0.43	0/1737
1	N	0.25	0/1289	0.43	0/1737
1	P	0.26	0/1289	0.44	0/1737
1	R	0.25	0/1289	0.42	0/1737
1	U	0.25	0/1289	0.42	0/1737
1	V	0.25	0/1289	0.43	0/1737
1	Y	0.25	0/1289	0.43	0/1737
2	D	0.24	0/1851	0.48	0/2511
2	E	0.24	0/1851	0.46	0/2511
2	H	0.24	0/1851	0.46	0/2511
2	I	0.24	0/1851	0.45	0/2511
2	L	0.24	0/1851	0.49	0/2511
2	M	0.24	0/1851	0.46	0/2511
2	O	0.24	0/1847	0.45	0/2507
2	Q	0.24	0/1851	0.47	0/2511
2	S	0.24	0/1781	0.45	0/2414
2	T	0.24	0/1826	0.45	0/2474
2	W	0.24	0/1851	0.47	0/2511
2	X	0.24	0/1851	0.46	0/2511
All	All	0.25	0/37459	0.45	0/50670

There are no bond length outliers.

There are no bond angle outliers.

There are no chirality outliers.

There are no planarity outliers.

## 5.2 Too-close contacts [i](#)

In the following table, the Non-H and H(model) columns list the number of non-hydrogen atoms and hydrogen atoms in the chain respectively. The H(added) column lists the number of hydrogen atoms added and optimized by MolProbity. The Clashes column lists the number of clashes within the asymmetric unit, whereas Symm-Clashes lists symmetry-related clashes.

Mol	Chain	Non-H	H(model)	H(added)	Clashes	Symm-Clashes
1	A	1171	0	1136	118	0
1	B	1239	0	1193	127	0
1	F	1264	0	1220	118	0
1	G	1264	0	1217	94	0
1	J	1264	0	1220	106	0
1	K	1264	0	1217	125	34
1	N	1264	0	1220	125	0
1	P	1264	0	1217	113	0
1	R	1264	0	1220	105	0
1	U	1264	0	1220	116	0
1	V	1264	0	1217	110	0
1	Y	1264	0	1217	95	0
2	D	1811	0	1811	222	0
2	E	1811	0	1808	250	0
2	H	1811	0	1811	211	0
2	I	1811	0	1808	213	0
2	L	1811	0	1811	219	0
2	M	1811	0	1808	231	0
2	O	1807	0	1800	171	0
2	Q	1811	0	1808	212	0
2	S	1744	0	1747	165	0
2	T	1789	0	1791	220	2
2	W	1811	0	1808	191	0
2	X	1811	0	1808	184	0
3	D	18	0	0	0	0
3	H	18	0	0	0	0
3	J	18	0	0	2	2
3	M	18	0	0	3	0
3	P	18	0	0	1	34
3	V	18	0	0	0	0
3	X	18	0	0	4	0
3	Y	18	0	0	3	0
All	All	36833	0	36133	3315	36

The all-atom clashscore is defined as the number of clashes found per 1000 atoms (including hydrogen atoms). The all-atom clashscore for this structure is 45.

The worst 5 of 3315 close contacts within the same asymmetric unit are listed below, sorted by

their clash magnitude.

Atom-1	Atom-2	Interatomic distance (Å)	Clash overlap (Å)
2:X:605:ILE:CD1	3:X:5:TBR:BR4	2.35	1.28
2:M:560:GLU:OE2	3:M:164:TBR:BR8	2.13	1.22
2:X:605:ILE:HD13	3:X:5:TBR:BR4	1.99	1.14
1:A:18:HIS:HB3	1:A:36:LEU:HD11	1.29	1.13
2:E:606:LEU:HB2	2:E:621:PHE:HB2	1.31	1.11

The worst 5 of 36 symmetry-related close contacts are listed below. The label for Atom-2 includes the symmetry operator and encoded unit-cell translations to be applied.

Atom-1	Atom-2	Interatomic distance (Å)	Clash overlap (Å)
1:K:655:TRP:CB	3:P:2:TBR:BR9[1_554]	0.28	1.92
1:K:654:ASP:CA	3:P:2:TBR:TA6[1_554]	0.64	1.56
2:T:176:ARG:NH1	3:J:164:TBR:BR5[1_556]	0.77	1.43
1:K:654:ASP:CB	3:P:2:TBR:BRB[1_554]	1.19	1.01
1:K:654:ASP:C	3:P:2:TBR:TA6[1_554]	1.24	0.96

## 5.3 Torsion angles [i](#)

### 5.3.1 Protein backbone [i](#)

In the following table, the Percentiles column shows the percent Ramachandran outliers of the chain as a percentile score with respect to all X-ray entries followed by that with respect to entries of similar resolution.

The Analysed column shows the number of residues for which the backbone conformation was analysed, and the total number of residues.

Mol	Chain	Analysed	Favoured	Allowed	Outliers	Percentiles	
1	A	145/163 (89%)	108 (74%)	27 (19%)	10 (7%)	1	16
1	B	148/163 (91%)	116 (78%)	21 (14%)	11 (7%)	1	15
1	F	155/163 (95%)	120 (77%)	31 (20%)	4 (3%)	5	34
1	G	155/163 (95%)	114 (74%)	35 (23%)	6 (4%)	3	26
1	J	155/163 (95%)	114 (74%)	30 (19%)	11 (7%)	1	16
1	K	155/163 (95%)	110 (71%)	34 (22%)	11 (7%)	1	16
1	N	155/163 (95%)	121 (78%)	26 (17%)	8 (5%)	2	21
1	P	155/163 (95%)	126 (81%)	23 (15%)	6 (4%)	3	26

*Continued on next page...*

Continued from previous page...

Mol	Chain	Analysed	Favoured	Allowed	Outliers	Percentiles	
1	R	155/163 (95%)	125 (81%)	22 (14%)	8 (5%)	2	21
1	U	155/163 (95%)	130 (84%)	17 (11%)	8 (5%)	2	21
1	V	155/163 (95%)	126 (81%)	21 (14%)	8 (5%)	2	21
1	Y	155/163 (95%)	125 (81%)	20 (13%)	10 (6%)	1	18
2	D	225/230 (98%)	160 (71%)	51 (23%)	14 (6%)	1	18
2	E	225/230 (98%)	157 (70%)	50 (22%)	18 (8%)	1	14
2	H	225/230 (98%)	166 (74%)	45 (20%)	14 (6%)	1	18
2	I	225/230 (98%)	164 (73%)	52 (23%)	9 (4%)	3	26
2	L	225/230 (98%)	153 (68%)	56 (25%)	16 (7%)	1	16
2	M	225/230 (98%)	156 (69%)	51 (23%)	18 (8%)	1	14
2	O	225/230 (98%)	156 (69%)	51 (23%)	18 (8%)	1	14
2	Q	225/230 (98%)	156 (69%)	48 (21%)	21 (9%)	0	11
2	S	214/230 (93%)	151 (71%)	46 (22%)	17 (8%)	1	14
2	T	220/230 (96%)	161 (73%)	39 (18%)	20 (9%)	1	12
2	W	225/230 (98%)	169 (75%)	41 (18%)	15 (7%)	1	17
2	X	225/230 (98%)	156 (69%)	54 (24%)	15 (7%)	1	17
All	All	4527/4716 (96%)	3340 (74%)	891 (20%)	296 (6%)	1	18

5 of 296 Ramachandran outliers are listed below:

Mol	Chain	Res	Type
1	A	25	GLU
2	D	94	THR
2	D	136	ILE
2	D	172	ALA
2	E	521	ASN

### 5.3.2 Protein sidechains [i](#)

In the following table, the Percentiles column shows the percent sidechain outliers of the chain as a percentile score with respect to all X-ray entries followed by that with respect to entries of similar resolution.

The Analysed column shows the number of residues for which the sidechain conformation was analysed, and the total number of residues.

Mol	Chain	Analysed	Rotameric	Outliers	Percentiles	
1	A	129/146 (88%)	108 (84%)	21 (16%)	2	15
1	B	138/146 (94%)	114 (83%)	24 (17%)	2	13
1	F	139/146 (95%)	115 (83%)	24 (17%)	2	13
1	G	139/146 (95%)	117 (84%)	22 (16%)	2	16
1	J	139/146 (95%)	126 (91%)	13 (9%)	8	31
1	K	139/146 (95%)	117 (84%)	22 (16%)	2	16
1	N	139/146 (95%)	119 (86%)	20 (14%)	3	19
1	P	139/146 (95%)	120 (86%)	19 (14%)	3	21
1	R	139/146 (95%)	131 (94%)	8 (6%)	20	48
1	U	139/146 (95%)	117 (84%)	22 (16%)	2	16
1	V	139/146 (95%)	117 (84%)	22 (16%)	2	16
1	Y	139/146 (95%)	119 (86%)	20 (14%)	3	19
2	D	201/204 (98%)	162 (81%)	39 (19%)	1	9
2	E	201/204 (98%)	166 (83%)	35 (17%)	2	13
2	H	201/204 (98%)	171 (85%)	30 (15%)	3	18
2	I	201/204 (98%)	171 (85%)	30 (15%)	3	18
2	L	201/204 (98%)	172 (86%)	29 (14%)	3	19
2	M	201/204 (98%)	178 (89%)	23 (11%)	5	25
2	O	200/204 (98%)	171 (86%)	29 (14%)	3	19
2	Q	201/204 (98%)	166 (83%)	35 (17%)	2	13
2	S	194/204 (95%)	166 (86%)	28 (14%)	3	19
2	T	199/204 (98%)	175 (88%)	24 (12%)	5	23
2	W	201/204 (98%)	176 (88%)	25 (12%)	4	23
2	X	201/204 (98%)	177 (88%)	24 (12%)	5	24
All	All	4059/4200 (97%)	3471 (86%)	588 (14%)	3	19

5 of 588 residues with a non-rotameric sidechain are listed below:

Mol	Chain	Res	Type
2	S	161	ASP
1	Y	552	ILE
2	W	522	SER
2	S	156	LEU
2	T	214	LEU

Sometimes sidechains can be flipped to improve hydrogen bonding and reduce clashes. 5 of 165 such sidechains are listed below:

Mol	Chain	Res	Type
1	R	141	ASN
2	T	133	GLN
1	V	587	ASN
2	S	226	HIS
2	X	647	GLN

### 5.3.3 RNA [i](#)

There are no RNA molecules in this entry.

### 5.4 Non-standard residues in protein, DNA, RNA chains [i](#)

There are no non-standard protein/DNA/RNA residues in this entry.

### 5.5 Carbohydrates [i](#)

There are no monosaccharides in this entry.

### 5.6 Ligand geometry [i](#)

8 ligands are modelled in this entry.

In the following table, the Counts columns list the number of bonds (or angles) for which Mogul statistics could be retrieved, the number of bonds (or angles) that are observed in the model and the number of bonds (or angles) that are defined in the Chemical Component Dictionary. The Link column lists molecule types, if any, to which the group is linked. The Z score for a bond length (or angle) is the number of standard deviations the observed value is removed from the expected value. A bond length (or angle) with  $|Z| > 2$  is considered an outlier worth inspection. RMSZ is the root-mean-square of all Z scores of the bond lengths (or angles).

Mol	Type	Chain	Res	Link	Bond lengths			Bond angles		
					Counts	RMSZ	$\# Z  > 2$	Counts	RMSZ	$\# Z  > 2$
3	TBR	Y	10	-	0,36,36	-	-	-		
3	TBR	V	1	-	0,36,36	-	-	-		
3	TBR	J	164	-	0,36,36	-	-	-		
3	TBR	P	2	-	0,36,36	-	-	-		
3	TBR	M	164	-	0,36,36	-	-	-		
3	TBR	H	231	-	0,36,36	-	-	-		
3	TBR	D	231	-	0,36,36	-	-	-		
3	TBR	X	5	-	0,36,36	-	-	-		



There are no bond length outliers.

There are no bond angle outliers.

There are no chirality outliers.

There are no torsion outliers.

There are no ring outliers.

5 monomers are involved in 49 short contacts:

Mol	Chain	Res	Type	Clashes	Symm-Clashes
3	Y	10	TBR	3	0
3	J	164	TBR	2	2
3	P	2	TBR	1	34
3	M	164	TBR	3	0
3	X	5	TBR	4	0

The following is a two-dimensional graphical depiction of Mogul quality analysis of bond lengths, bond angles, torsion angles, and ring geometry for all instances of the Ligand of Interest. In addition, ligands with molecular weight > 250 and outliers as shown on the validation Tables will also be included. For torsion angles, if less than 5% of the Mogul distribution of torsion angles is within 10 degrees of the torsion angle in question, then that torsion angle is considered an outlier. Any bond that is central to one or more torsion angles identified as an outlier by Mogul will be highlighted in the graph. For rings, the root-mean-square deviation (RMSD) between the ring in question and similar rings identified by Mogul is calculated over all ring torsion angles. If the average RMSD is greater than 60 degrees and the minimal RMSD between the ring in question and any Mogul-identified rings is also greater than 60 degrees, then that ring is considered an outlier. The outliers are highlighted in purple. The color gray indicates Mogul did not find sufficient equivalents in the CSD to analyse the geometry.

## Ligand TBR J 164

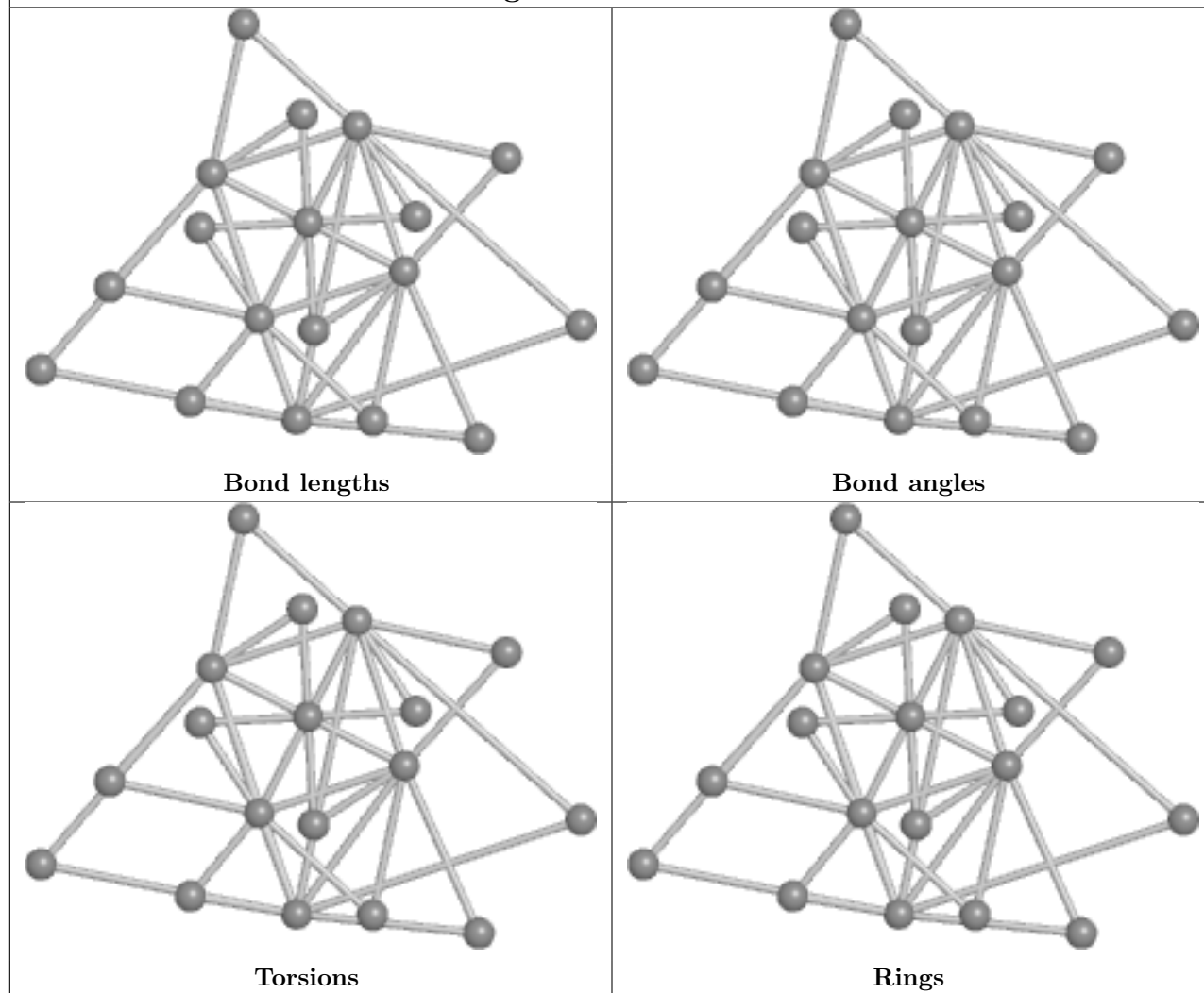

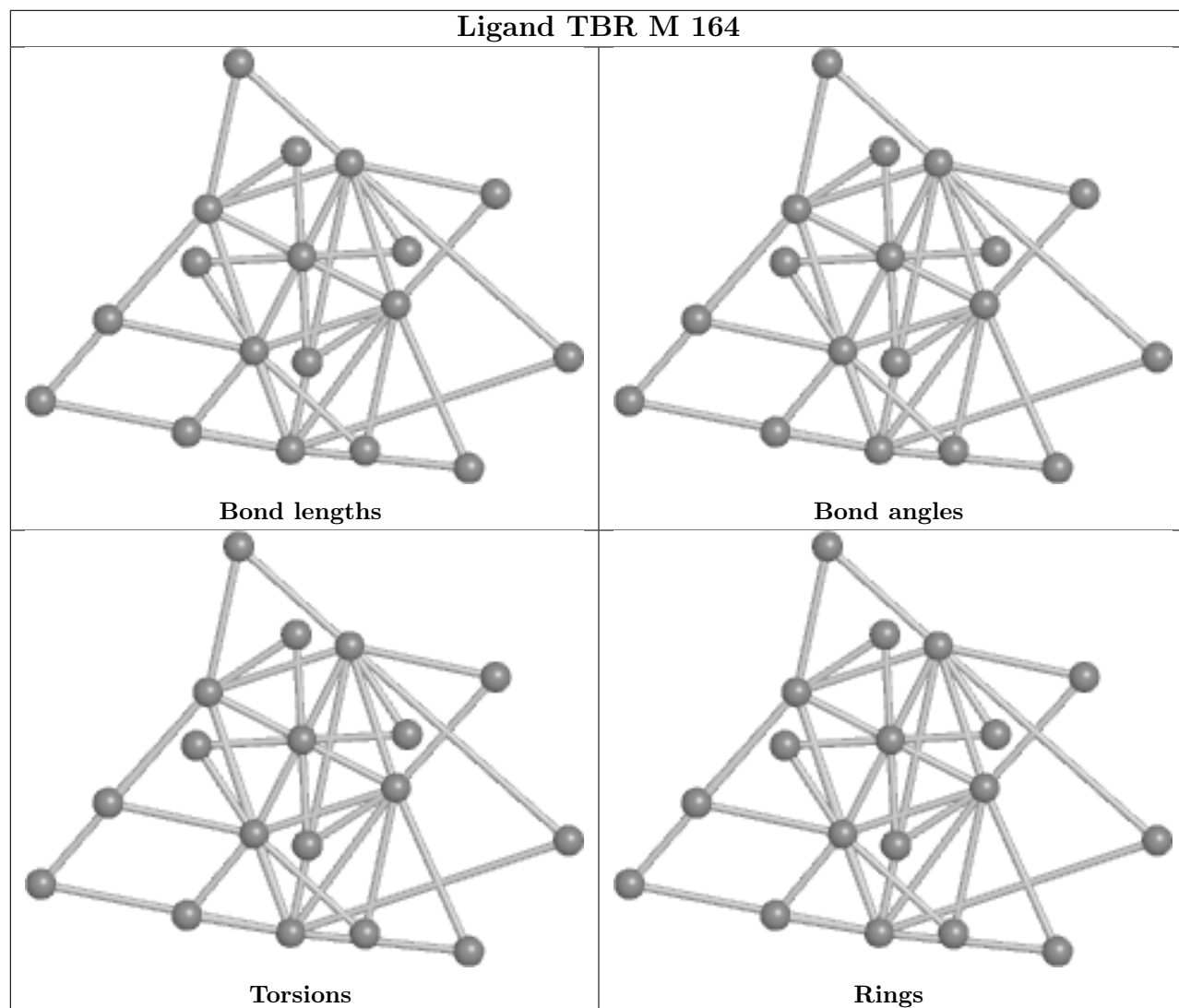

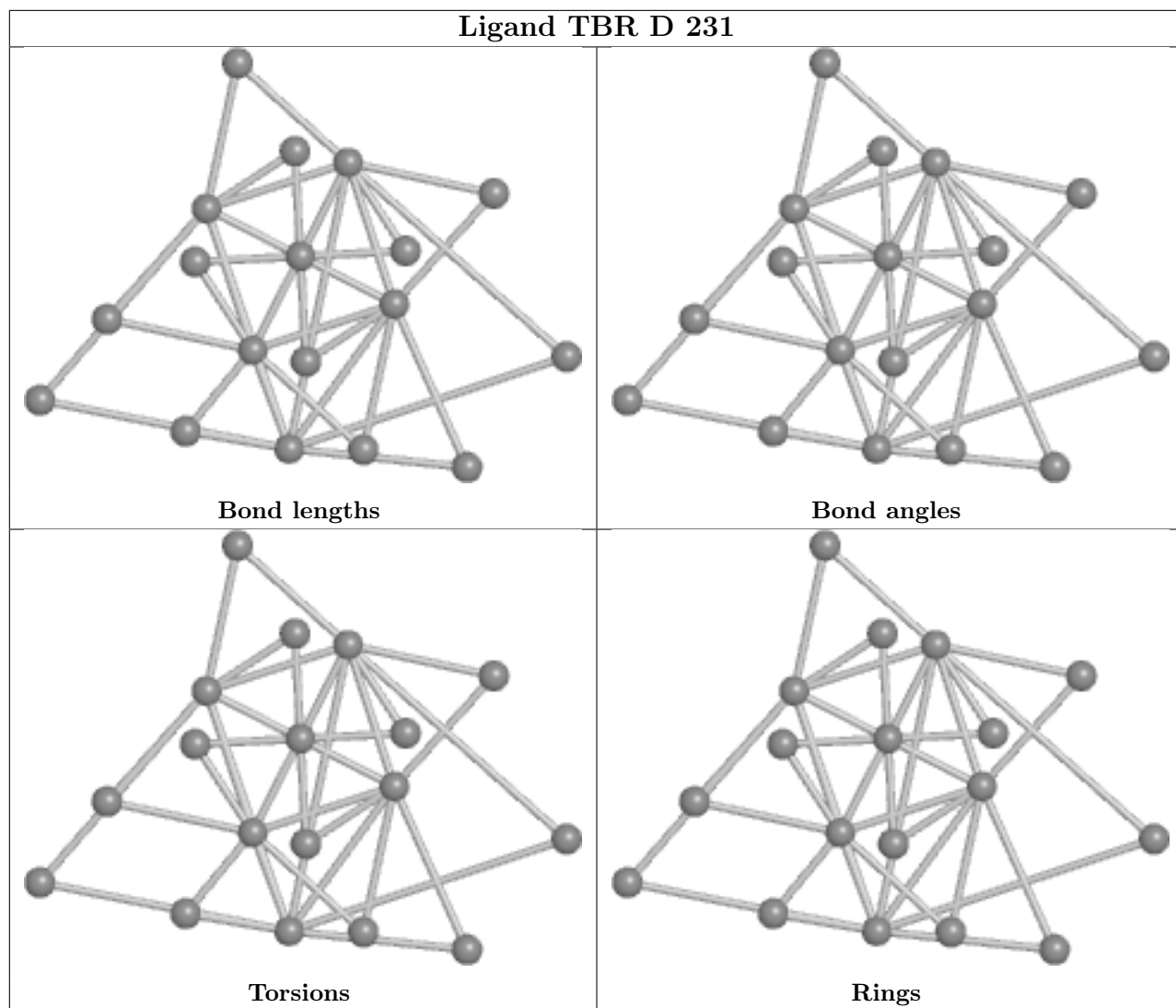

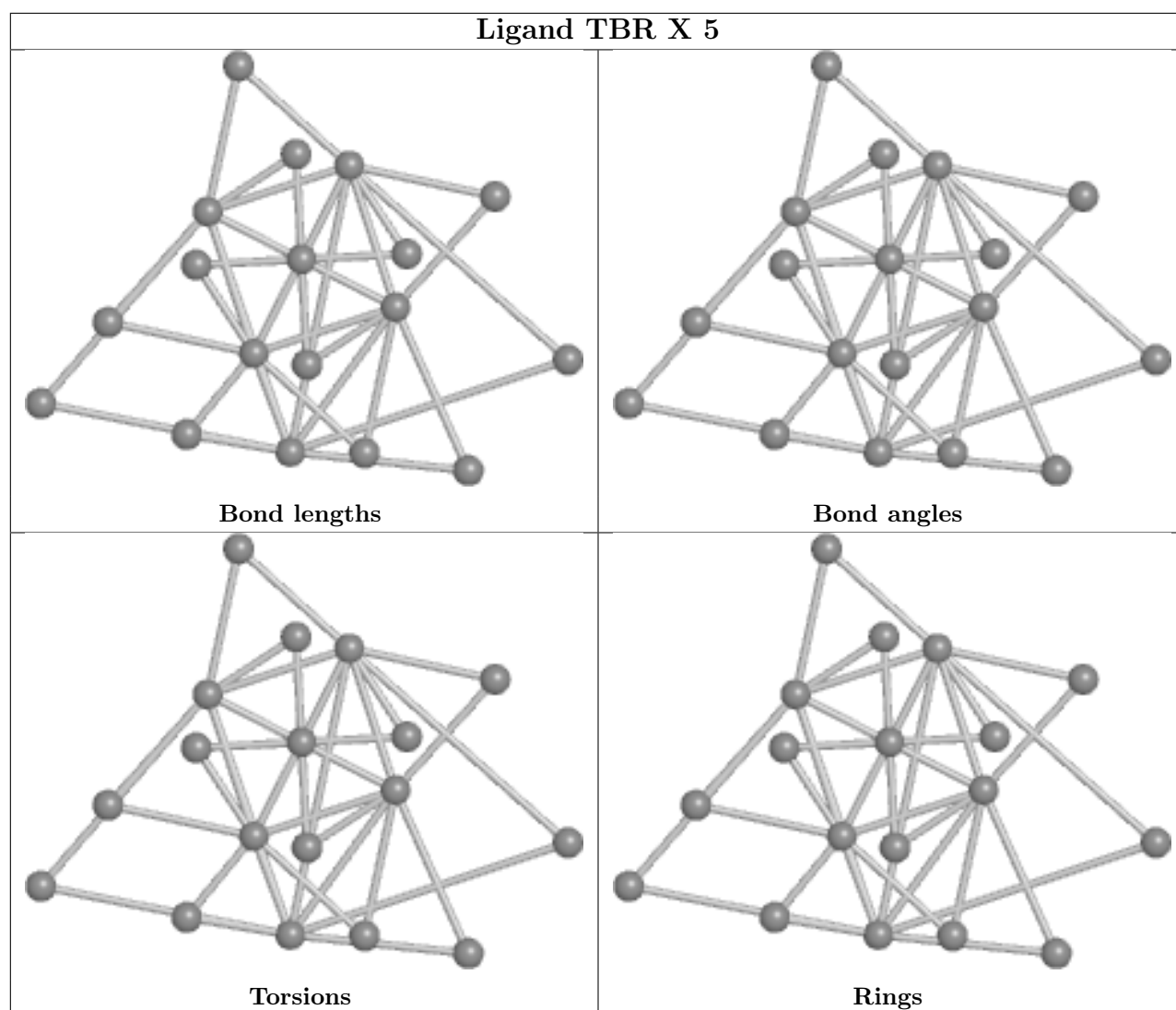

## 5.7 Other polymers [i](#)

There are no such residues in this entry.

## 5.8 Polymer linkage issues [i](#)

There are no chain breaks in this entry.

## 6 Fit of model and data [i](#)

### 6.1 Protein, DNA and RNA chains [i](#)

In the following table, the column labelled ‘#RSRZ > 2’ contains the number (and percentage) of RSRZ outliers, followed by percent RSRZ outliers for the chain as percentile scores relative to all X-ray entries and entries of similar resolution. The OWAB column contains the minimum, median, 95<sup>th</sup> percentile and maximum values of the occupancy-weighted average B-factor per residue. The column labelled ‘Q < 0.9’ lists the number of (and percentage) of residues with an average occupancy less than 0.9.

Mol	Chain	Analysed	<RSRZ>	#RSRZ>2	OWAB(Å <sup>2</sup> )	Q<0.9
1	A	147/163 (90%)	0.80	22 (14%) 2 2	143, 217, 261, 290	0
1	B	152/163 (93%)	0.60	19 (12%) 3 5	130, 199, 240, 289	0
1	F	157/163 (96%)	0.35	17 (10%) 5 5	121, 173, 263, 314	0
1	G	157/163 (96%)	0.30	11 (7%) 16 13	119, 173, 217, 265	0
1	J	157/163 (96%)	0.48	19 (12%) 4 5	168, 209, 241, 255	0
1	K	157/163 (96%)	0.66	21 (13%) 3 3	175, 216, 268, 312	0
1	N	157/163 (96%)	0.14	7 (4%) 33 28	115, 159, 206, 250	0
1	P	157/163 (96%)	0.31	4 (2%) 57 47	109, 169, 230, 262	0
1	R	157/163 (96%)	0.19	5 (3%) 47 37	145, 184, 217, 234	0
1	U	157/163 (96%)	0.22	8 (5%) 28 24	147, 184, 233, 291	0
1	V	157/163 (96%)	0.19	4 (2%) 57 47	123, 184, 219, 273	0
1	Y	157/163 (96%)	0.51	17 (10%) 5 5	148, 202, 251, 276	0
2	D	227/230 (98%)	0.06	2 (0%) 84 77	87, 144, 202, 244	0
2	E	227/230 (98%)	0.23	13 (5%) 23 20	99, 156, 233, 269	0
2	H	227/230 (98%)	0.12	5 (2%) 62 52	107, 152, 210, 256	0
2	I	227/230 (98%)	0.25	11 (4%) 30 26	113, 156, 213, 277	0
2	L	227/230 (98%)	0.12	4 (1%) 68 60	98, 152, 218, 251	0
2	M	227/230 (98%)	0.13	7 (3%) 49 38	106, 167, 210, 244	0
2	O	227/230 (98%)	0.19	9 (3%) 38 31	109, 165, 225, 311	0
2	Q	227/230 (98%)	0.20	4 (1%) 68 60	99, 150, 211, 239	0
2	S	218/230 (94%)	-0.02	1 (0%) 91 85	111, 167, 216, 241	0
2	T	224/230 (97%)	0.24	12 (5%) 25 22	146, 199, 243, 267	0
2	W	227/230 (98%)	0.18	6 (2%) 56 46	107, 160, 206, 242	0
2	X	227/230 (98%)	0.17	11 (4%) 30 26	140, 189, 233, 303	0

*Continued on next page...*

Continued from previous page...

Mol	Chain	Analysed	<RSRZ>	#RSRZ>2	OWAB(Å <sup>2</sup> )	Q<0.9
All	All	4581/4716 (97%)	0.25	239 (5%) 27 24	87, 175, 238, 314	0

The worst 5 of 239 RSRZ outliers are listed below:

Mol	Chain	Res	Type	RSRZ
1	F	151	LEU	6.6
2	E	591	SER	6.4
1	G	529	GLU	5.7
1	J	81	ALA	5.7
2	O	89	HIS	5.6

## 6.2 Non-standard residues in protein, DNA, RNA chains [i](#)

There are no non-standard protein/DNA/RNA residues in this entry.

## 6.3 Carbohydrates [i](#)

There are no monosaccharides in this entry.

## 6.4 Ligands [i](#)

In the following table, the Atoms column lists the number of modelled atoms in the group and the number defined in the chemical component dictionary. The B-factors column lists the minimum, median, 95<sup>th</sup> percentile and maximum values of B factors of atoms in the group. The column labelled 'Q< 0.9' lists the number of atoms with occupancy less than 0.9.

Mol	Type	Chain	Res	Atoms	RSCC	RSR	B-factors(Å <sup>2</sup> )	Q<0.9
3	TBR	J	164	18/18	0.55	0.56	162,195,258,266	18
3	TBR	D	231	18/18	0.63	0.45	126,168,199,206	18
3	TBR	X	5	18/18	0.72	0.41	134,172,195,230	18
3	TBR	M	164	18/18	0.73	0.42	151,181,255,301	18
3	TBR	H	231	18/18	0.79	0.38	128,160,180,224	18
3	TBR	P	2	18/18	0.83	0.17	210,281,466,490	18
3	TBR	V	1	18/18	0.87	0.26	103,151,191,204	18
3	TBR	Y	10	18/18	0.89	0.20	130,168,192,193	18

The following is a graphical depiction of the model fit to experimental electron density of all instances of the Ligand of Interest. In addition, ligands with molecular weight > 250 and outliers as shown on the geometry validation Tables will also be included. Each fit is shown from different orientation to approximate a three-dimensional view.

**Electron density around TBR J 164:**

$2mF_o-DF_c$  (at 0.7 rmsd) in gray  
 $mF_o-DF_c$  (at 3 rmsd) in purple (negative)  
and green (positive)

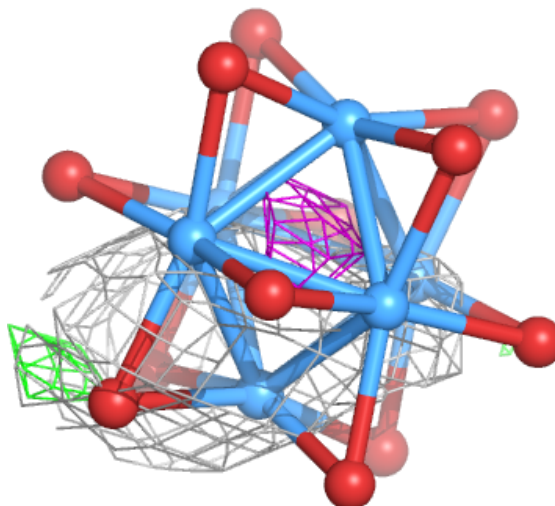
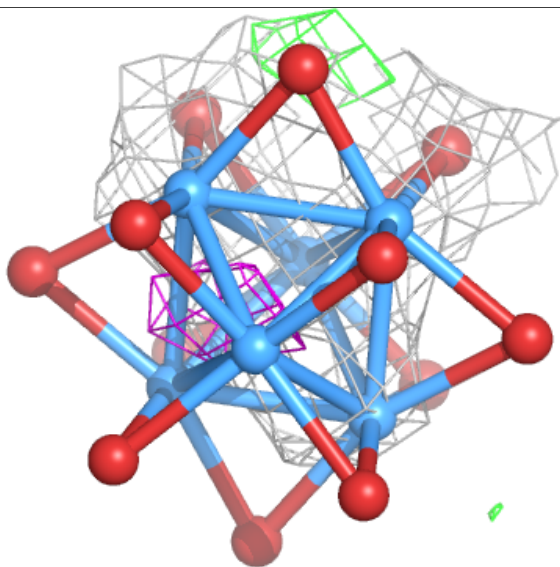
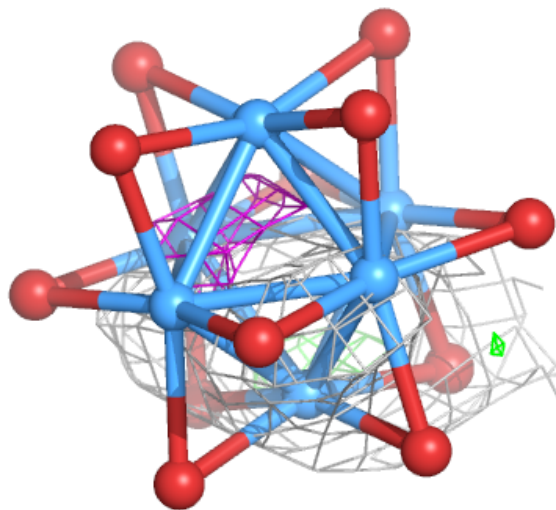



**Electron density around TBR D 231:**

$2mF_o-DF_c$  (at 0.7 rmsd) in gray  
 $mF_o-DF_c$  (at 3 rmsd) in purple (negative)  
and green (positive)

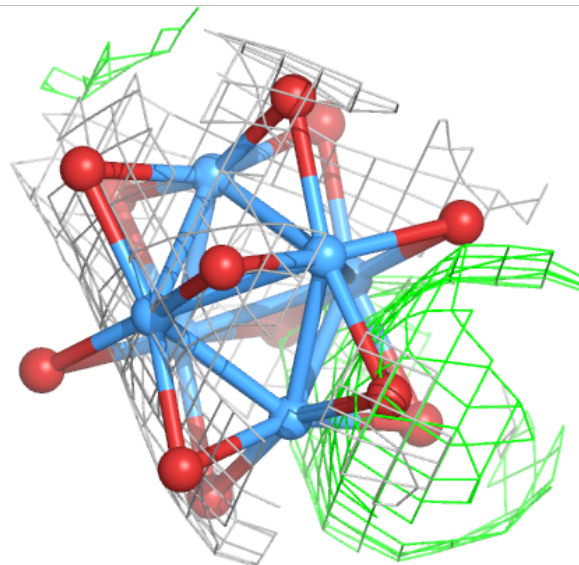
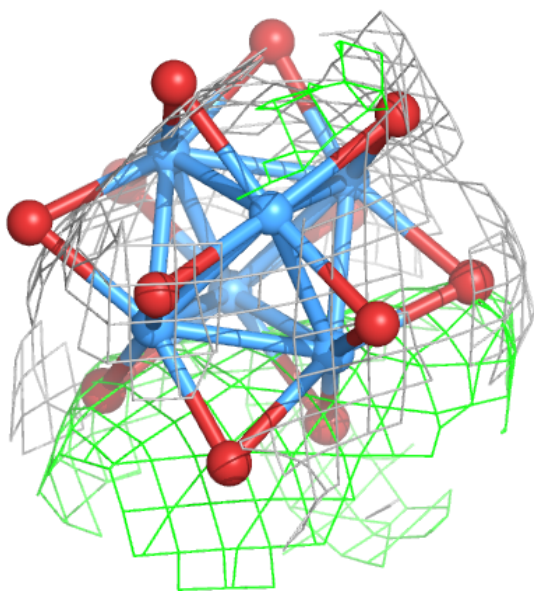
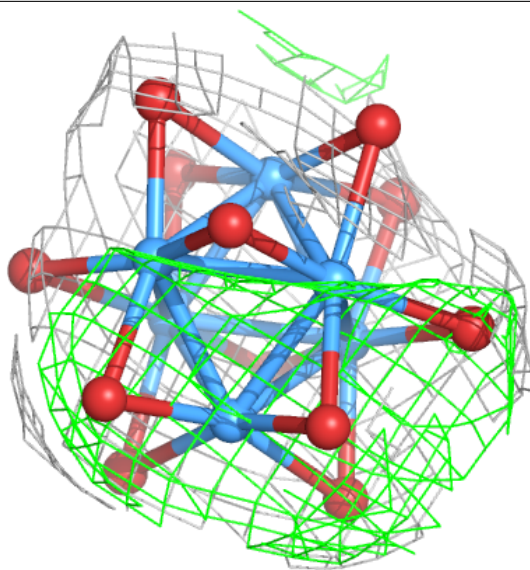

**Electron density around TBR X 5:**

$2mF_o-DF_c$  (at 0.7 rmsd) in gray  
 $mF_o-DF_c$  (at 3 rmsd) in purple (negative)  
and green (positive)

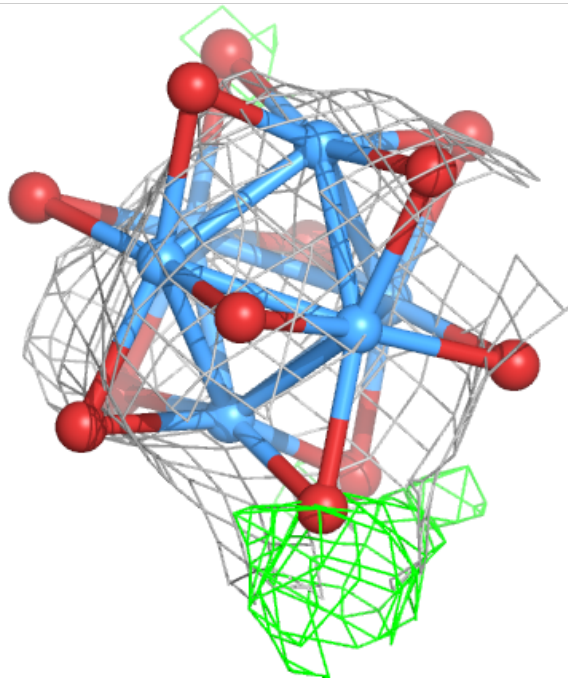
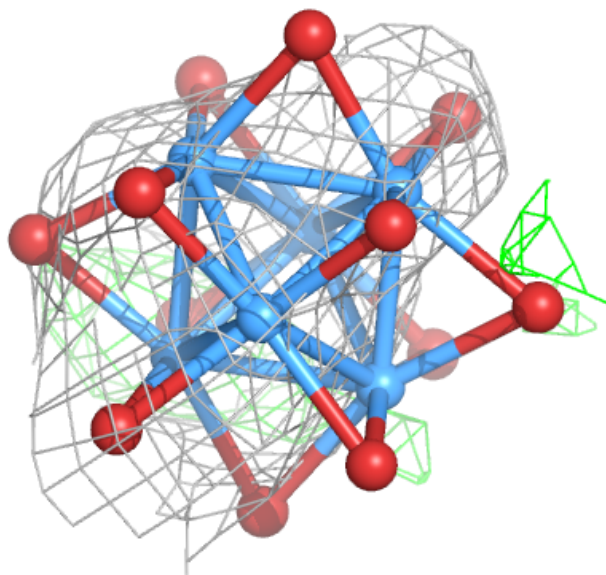
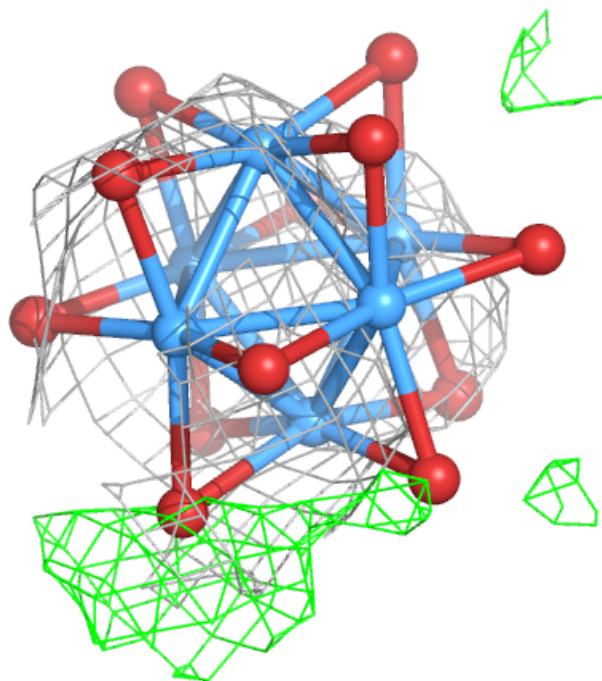

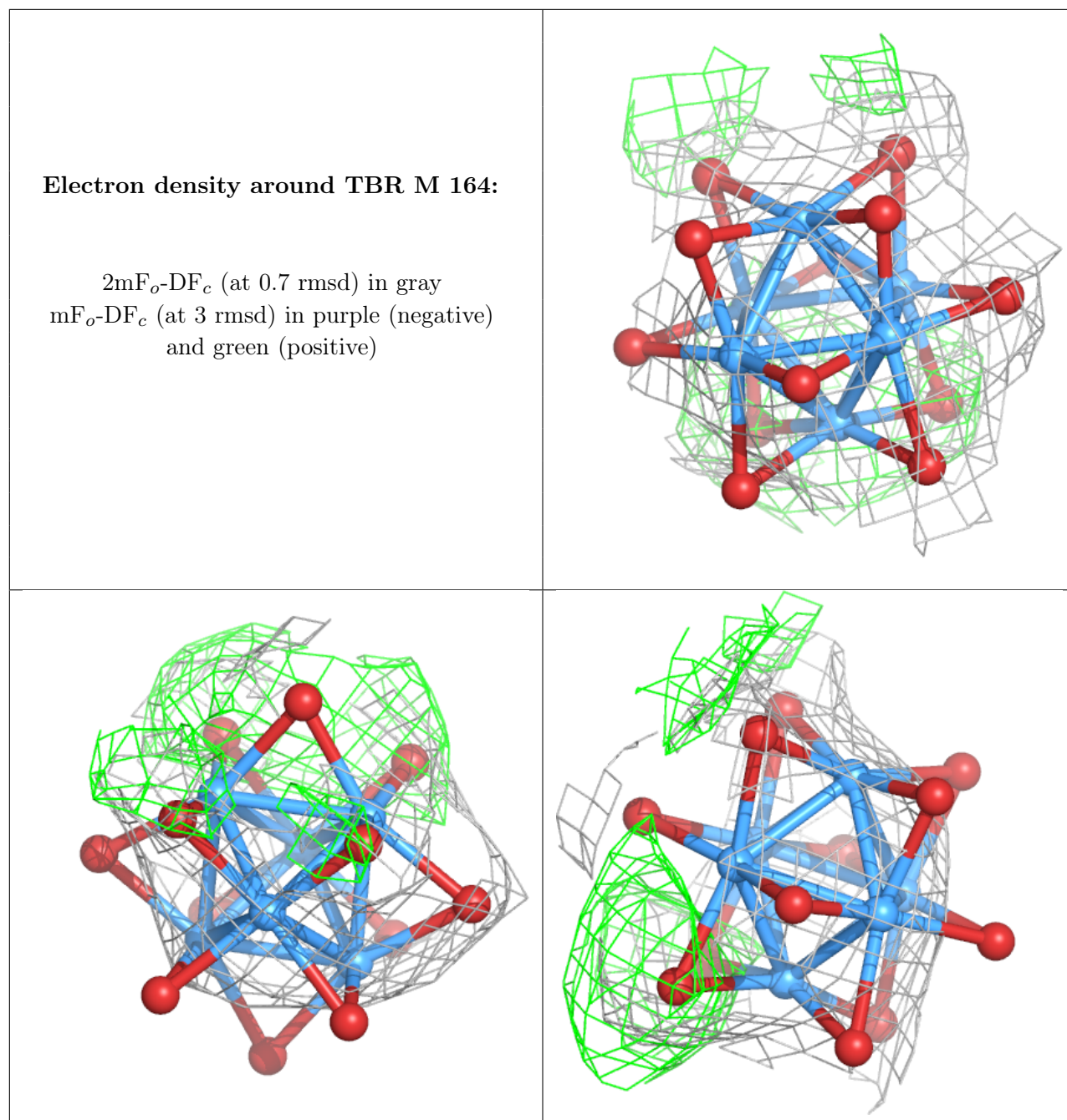

## 6.5 Other polymers [i](#)

There are no such residues in this entry.