



Full wwPDB X-ray Structure Validation Report ⓘ

Apr 4, 2024 – 01:16 pm BST

PDB ID : 8RON
Title : Crystal structure of human FAD synthase, isoform 2
Authors : Leo, G.; Capaldi, S.
Deposited on : 2024-01-11
Resolution : 2.60 Å(reported)

This is a Full wwPDB X-ray Structure Validation Report for a publicly released PDB entry.

We welcome your comments at validation@mail.wwpdb.org

A user guide is available at

<https://www.wwpdb.org/validation/2017/XrayValidationReportHelp>

with specific help available everywhere you see the ⓘ symbol.

The types of validation reports are described at

<http://www.wwpdb.org/validation/2017/FAQs#types>.

The following versions of software and data (see [references ⓘ](#)) were used in the production of this report:

MolProbity : 4.02b-467
Xtriage (Phenix) : 1.13
EDS : 2.36
Percentile statistics : 20191225.v01 (using entries in the PDB archive December 25th 2019)
Refmac : 5.8.0158
CCP4 : 7.0.044 (Gargrove)
Ideal geometry (proteins) : Engh & Huber (2001)
Ideal geometry (DNA, RNA) : Parkinson et al. (1996)
Validation Pipeline (wwPDB-VP) : 2.36

1 Overall quality at a glance

The following experimental techniques were used to determine the structure:

X-RAY DIFFRACTION

The reported resolution of this entry is 2.60 Å.

Percentile scores (ranging between 0-100) for global validation metrics of the entry are shown in the following graphic. The table shows the number of entries on which the scores are based.

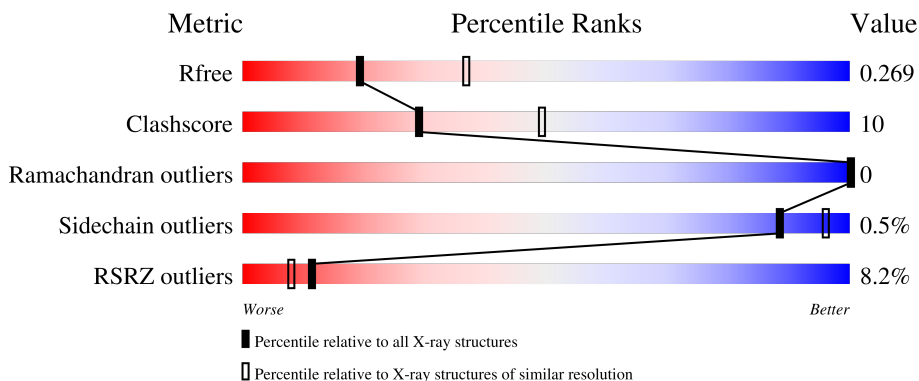

Metric	Whole archive (#Entries)	Similar resolution (#Entries, resolution range(Å))
R_{free}	130704	3163 (2.60-2.60)
Clashscore	141614	3518 (2.60-2.60)
Ramachandran outliers	138981	3455 (2.60-2.60)
Sidechain outliers	138945	3455 (2.60-2.60)
RSRZ outliers	127900	3104 (2.60-2.60)

The table below summarises the geometric issues observed across the polymeric chains and their fit to the electron density. The red, orange, yellow and green segments of the lower bar indicate the fraction of residues that contain outliers for ≥ 3 , 2, 1 and 0 types of geometric quality criteria respectively. A grey segment represents the fraction of residues that are not modelled. The numeric value for each fraction is indicated below the corresponding segment, with a dot representing fractions $\leq 5\%$. The upper red bar (where present) indicates the fraction of residues that have poor fit to the electron density. The numeric value is given above the bar.

Mol	Chain	Length	Quality of chain
1	A	482	 9% 75% 19% 5%
1	B	482	 5% 80% 17% .
1	C	482	 11% 74% 22% .
1	D	482	 7% 81% 16% .

2 Entry composition i

There is only 1 type of molecule in this entry. The entry contains 28825 atoms, of which 14327 are hydrogens and 0 are deuteriums.

In the tables below, the ZeroOcc column contains the number of atoms modelled with zero occupancy, the AltConf column contains the number of residues with at least one atom in alternate conformation and the Trace column contains the number of residues modelled with at most 2 atoms.

- Molecule 1 is a protein called Isoform 2 of FAD synthase.

Mol	Chain	Residues	Atoms					ZeroOcc	AltConf	Trace	
			Total	C	H	N	O				S
1	A	456	7067	2270	3516	603	663	15	0	0	0
1	B	469	7286	2337	3621	624	688	16	0	0	0
1	C	466	7238	2324	3598	617	683	16	0	0	0
1	D	466	7234	2322	3592	620	685	15	0	0	0

There are 16 discrepancies between the modelled and reference sequences:

Chain	Residue	Modelled	Actual	Comment	Reference
A	106	GLY	-	expression tag	UNP Q8NFF5
A	107	SER	-	expression tag	UNP Q8NFF5
A	108	HIS	-	expression tag	UNP Q8NFF5
A	109	MET	-	expression tag	UNP Q8NFF5
B	106	GLY	-	expression tag	UNP Q8NFF5
B	107	SER	-	expression tag	UNP Q8NFF5
B	108	HIS	-	expression tag	UNP Q8NFF5
B	109	MET	-	expression tag	UNP Q8NFF5
C	106	GLY	-	expression tag	UNP Q8NFF5
C	107	SER	-	expression tag	UNP Q8NFF5
C	108	HIS	-	expression tag	UNP Q8NFF5
C	109	MET	-	expression tag	UNP Q8NFF5
D	106	GLY	-	expression tag	UNP Q8NFF5
D	107	SER	-	expression tag	UNP Q8NFF5
D	108	HIS	-	expression tag	UNP Q8NFF5
D	109	MET	-	expression tag	UNP Q8NFF5

3 Residue-property plots [i](#)

These plots are drawn for all protein, RNA, DNA and oligosaccharide chains in the entry. The first graphic for a chain summarises the proportions of the various outlier classes displayed in the second graphic. The second graphic shows the sequence view annotated by issues in geometry and electron density. Residues are color-coded according to the number of geometric quality criteria for which they contain at least one outlier: green = 0, yellow = 1, orange = 2 and red = 3 or more. A red dot above a residue indicates a poor fit to the electron density ($RSRZ > 2$). Stretches of 2 or more consecutive residues without any outlier are shown as a green connector. Residues present in the sample, but not in the model, are shown in grey.

- Molecule 1: Isoform 2 of FAD synthase

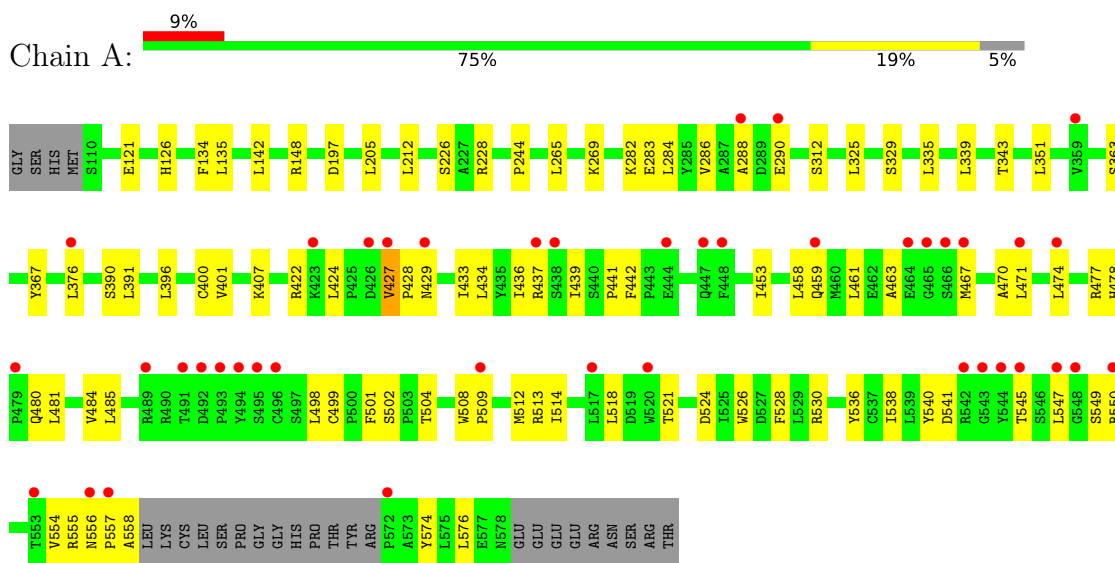

- Molecule 1: Isoform 2 of FAD synthase

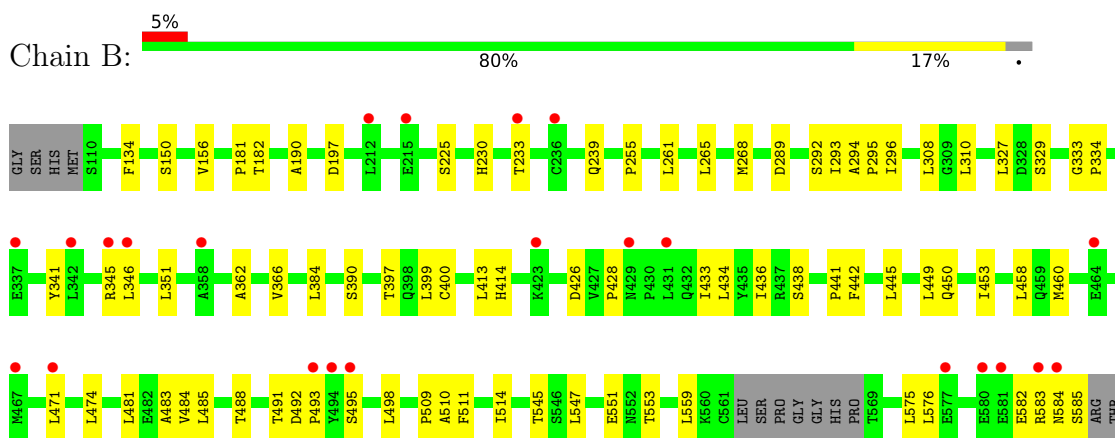

- Molecule 1: Isoform 2 of FAD synthase

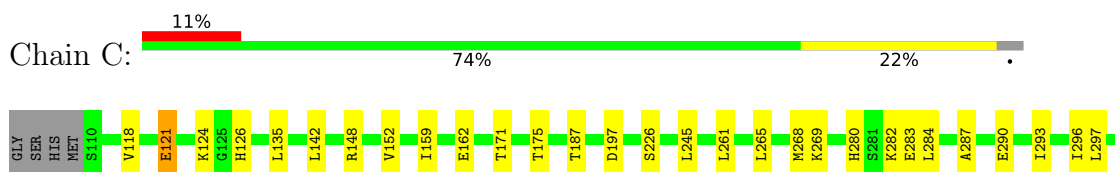

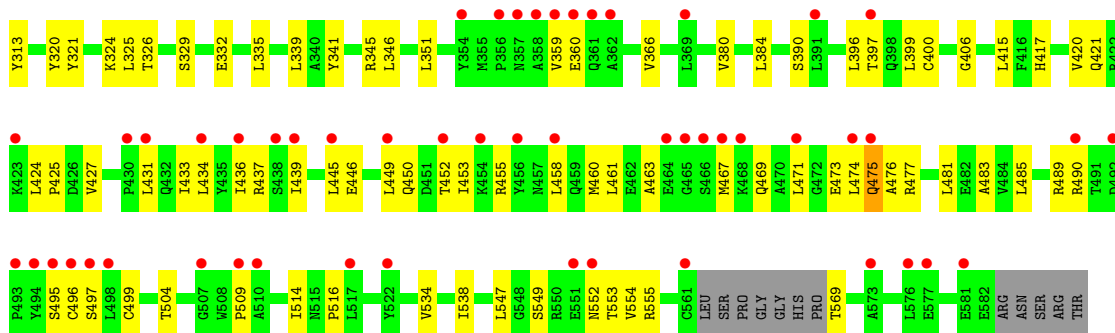

● Molecule 1: Isoform 2 of FAD synthase

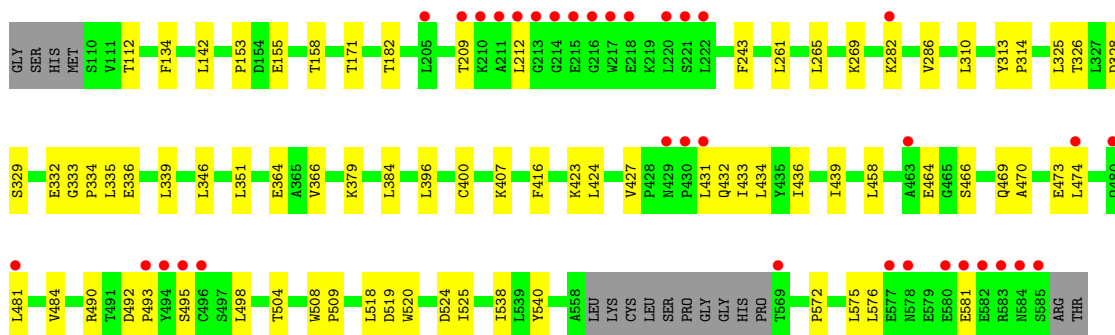
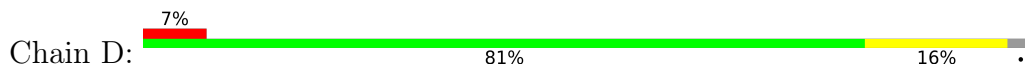

4 Data and refinement statistics

Property	Value	Source
Space group	P 1 21 1	Depositor
Cell constants a, b, c, α , β , γ	75.75Å 187.74Å 79.38Å 90.00° 96.45° 90.00°	Depositor
Resolution (Å)	58.72 – 2.60 58.72 – 2.49	Depositor EDS
% Data completeness (in resolution range)	64.3 (58.72-2.60) 56.9 (58.72-2.49)	Depositor EDS
R_{merge}	(Not available)	Depositor
R_{sym}	(Not available)	Depositor
$\langle I/\sigma(I) \rangle$ ¹	1.78 (at 2.48Å)	Xtrriage
Refinement program	PHENIX 1.19_4092	Depositor
R, R_{free}	0.215 , 0.268 0.216 , 0.269	Depositor DCC
R_{free} test set	2171 reflections (4.95%)	wwPDB-VP
Wilson B-factor (Å ²)	59.2	Xtrriage
Anisotropy	0.070	Xtrriage
Bulk solvent k_{sol} (e/Å ³), B_{sol} (Å ²)	0.34 , 40.2	EDS
L-test for twinning ²	$\langle L \rangle = 0.48$, $\langle L^2 \rangle = 0.31$	Xtrriage
Estimated twinning fraction	0.031 for l,-k,h	Xtrriage
F_o, F_c correlation	0.91	EDS
Total number of atoms	28825	wwPDB-VP
Average B, all atoms (Å ²)	83.0	wwPDB-VP

Xtrriage's analysis on translational NCS is as follows: *The largest off-origin peak in the Patterson function is 3.47% of the height of the origin peak. No significant pseudotranslation is detected.*

¹Intensities estimated from amplitudes.

²Theoretical values of $\langle |L| \rangle$, $\langle L^2 \rangle$ for acentric reflections are 0.5, 0.333 respectively for untwinned datasets, and 0.375, 0.2 for perfectly twinned datasets.

5 Model quality [i](#)

5.1 Standard geometry [i](#)

The Z score for a bond length (or angle) is the number of standard deviations the observed value is removed from the expected value. A bond length (or angle) with $|Z| > 5$ is considered an outlier worth inspection. RMSZ is the root-mean-square of all Z scores of the bond lengths (or angles).

Mol	Chain	Bond lengths		Bond angles	
		RMSZ	# Z >5	RMSZ	# Z >5
1	A	0.36	0/3639	0.58	0/4954
1	B	0.33	0/3754	0.56	1/5108 (0.0%)
1	C	0.40	2/3729 (0.1%)	0.62	3/5075 (0.1%)
1	D	0.33	0/3731	0.57	0/5078
All	All	0.36	2/14853 (0.0%)	0.58	4/20215 (0.0%)

All (2) bond length outliers are listed below:

Mol	Chain	Res	Type	Atoms	Z	Observed(Å)	Ideal(Å)
1	C	121	GLU	CD-OE1	-11.54	1.12	1.25
1	C	121	GLU	CG-CD	-6.06	1.42	1.51

All (4) bond angle outliers are listed below:

Mol	Chain	Res	Type	Atoms	Z	Observed(°)	Ideal(°)
1	C	121	GLU	CG-CD-OE2	11.35	141.00	118.30
1	C	121	GLU	OE1-CD-OE2	-9.94	111.37	123.30
1	C	121	GLU	CG-CD-OE1	-5.91	106.47	118.30
1	B	575	LEU	CB-CG-CD2	5.19	119.83	111.00

There are no chirality outliers.

There are no planarity outliers.

5.2 Too-close contacts [i](#)

In the following table, the Non-H and H(model) columns list the number of non-hydrogen atoms and hydrogen atoms in the chain respectively. The H(added) column lists the number of hydrogen atoms added and optimized by MolProbity. The Clashes column lists the number of clashes within the asymmetric unit, whereas Symm-Clashes lists symmetry-related clashes.

Mol	Chain	Non-H	H(model)	H(added)	Clashes	Symm-Clashes
1	A	3551	3516	3516	86	1
1	B	3665	3621	3621	63	1
1	C	3640	3598	3597	79	2
1	D	3642	3592	3592	58	0
All	All	14498	14327	14326	276	2

The all-atom clashscore is defined as the number of clashes found per 1000 atoms (including hydrogen atoms). The all-atom clashscore for this structure is 10.

All (276) close contacts within the same asymmetric unit are listed below, sorted by their clash magnitude.

Atom-1	Atom-2	Interatomic distance (Å)	Clash overlap (Å)
1:D:434:LEU:HD13	1:D:474:LEU:HD12	1.57	0.87
1:D:282:LYS:NZ	1:D:332:GLU:OE2	2.08	0.86
1:C:445:LEU:HD12	1:C:547:LEU:HD13	1.57	0.85
1:D:433:ILE:HD13	1:D:458:LEU:HD13	1.59	0.83
1:D:490:ARG:NH1	1:D:519:ASP:OD1	2.13	0.81
1:B:471:LEU:HD23	1:B:509:PRO:HD2	1.66	0.76
1:B:400:CYS:SG	1:B:484:VAL:HG22	2.27	0.74
1:D:474:LEU:HD21	1:D:481:LEU:HD12	1.68	0.74
1:A:197:ASP:OD2	1:A:226:SER:OG	2.01	0.74
1:C:135:LEU:HD23	1:C:265:LEU:HD22	1.69	0.74
1:B:449:LEU:HD21	1:B:460:MET:CE	2.19	0.72
1:C:461:LEU:HB3	1:C:474:LEU:HD11	1.72	0.71
1:C:406:GLY:HA2	1:C:547:LEU:HD12	1.71	0.70
1:B:449:LEU:HD21	1:B:460:MET:HE2	1.73	0.70
1:C:504:THR:HG21	1:C:509:PRO:O	1.92	0.70
1:A:485:LEU:HD23	1:A:514:ILE:HB	1.73	0.69
1:A:283:GLU:C	1:A:284:LEU:HD12	2.14	0.68
1:C:359:VAL:HG11	1:C:417:HIS:CE1	2.29	0.68
1:C:346:LEU:HD12	1:C:351:LEU:HD11	1.75	0.67
1:B:197:ASP:OD1	1:B:225:SER:OG	2.13	0.67
1:B:551:GLU:OE1	1:B:551:GLU:N	2.27	0.65
1:C:485:LEU:HD23	1:C:514:ILE:HB	1.77	0.65
1:B:471:LEU:HD11	1:B:511:PHE:CD1	2.31	0.65
1:D:400:CYS:SG	1:D:484:VAL:HG22	2.36	0.64
1:A:290:GLU:CG	1:B:182:THR:HG23	2.27	0.64
1:D:504:THR:HG22	1:D:508:TRP:HB2	1.79	0.64
1:A:135:LEU:HD23	1:A:265:LEU:HD22	1.79	0.64
1:A:148:ARG:NH2	1:B:150:SER:OG	2.31	0.64
1:A:401:VAL:HG22	1:A:485:LEU:HD12	1.79	0.63
1:C:346:LEU:CD1	1:C:351:LEU:HD11	2.28	0.63

Continued on next page...

Continued from previous page...

Atom-1	Atom-2	Interatomic distance (Å)	Clash overlap (Å)
1:A:429:ASN:ND2	1:A:429:ASN:O	2.31	0.63
1:B:559:LEU:HD21	1:B:576:LEU:HB2	1.81	0.62
1:C:297:LEU:HD21	1:C:325:LEU:HD21	1.81	0.62
1:C:390:SER:OG	1:C:514:ILE:HD13	2.00	0.62
1:C:283:GLU:C	1:C:284:LEU:HD12	2.20	0.62
1:D:346:LEU:HD12	1:D:351:LEU:HD11	1.82	0.62
1:A:400:CYS:SG	1:A:484:VAL:HG22	2.39	0.61
1:C:420:VAL:HG11	1:C:431:LEU:HD21	1.81	0.61
1:D:504:THR:CG2	1:D:508:TRP:HB2	2.31	0.61
1:A:436:ILE:O	1:A:436:ILE:HD12	2.01	0.61
1:B:413:LEU:HD21	1:B:458:LEU:HD11	1.82	0.60
1:D:261:LEU:HD23	1:D:261:LEU:C	2.21	0.60
1:A:391:LEU:CD2	1:A:396:LEU:HD21	2.31	0.60
1:D:364:GLU:N	1:D:364:GLU:OE1	2.35	0.60
1:A:461:LEU:HD21	1:A:478:HIS:NE2	2.17	0.60
1:A:474:LEU:HD21	1:A:481:LEU:HD13	1.83	0.59
1:C:436:ILE:HG22	1:C:463:ALA:HB3	1.83	0.59
1:C:399:LEU:HD23	1:C:483:ALA:HB3	1.86	0.58
1:D:416:PHE:CE2	1:D:431:LEU:HD22	2.39	0.57
1:B:510:ALA:O	1:B:511:PHE:CD1	2.57	0.57
1:C:121:GLU:OE1	1:C:126:HIS:HB2	2.05	0.57
1:D:427:VAL:HG23	1:D:427:VAL:O	2.05	0.57
1:D:474:LEU:HD21	1:D:481:LEU:CD1	2.34	0.57
1:C:148:ARG:NH2	1:D:158:THR:HG23	2.19	0.56
1:B:445:LEU:HD12	1:B:547:LEU:HD13	1.88	0.56
1:A:142:LEU:HD11	1:A:269:LYS:HB2	1.87	0.56
1:A:286:VAL:HG12	1:A:288:ALA:H	1.70	0.56
1:A:427:VAL:HG13	1:A:428:PRO:HD2	1.88	0.56
1:A:474:LEU:HD21	1:A:481:LEU:CD1	2.35	0.56
1:A:282:LYS:HG3	1:A:335:LEU:HD23	1.86	0.56
1:B:442:PHE:CE2	1:B:553:THR:HG21	2.40	0.56
1:A:339:LEU:O	1:A:343:THR:HG23	2.05	0.55
1:D:142:LEU:HD21	1:D:269:LYS:HD2	1.88	0.55
1:A:407:LYS:HE2	1:A:540:TYR:CE1	2.41	0.55
1:D:490:ARG:NH1	1:D:518:LEU:HB3	2.21	0.55
1:A:540:TYR:CZ	1:A:547:LEU:HG	2.41	0.55
1:C:396:LEU:HD22	1:C:427:VAL:CG2	2.37	0.55
1:B:450:GLN:OE1	1:B:453:ILE:HD11	2.06	0.55
1:C:437:ARG:NH2	1:C:446:GLU:OE2	2.35	0.55
1:D:469:GLN:O	1:D:473:GLU:HG3	2.07	0.55
1:B:471:LEU:HD11	1:B:511:PHE:CG	2.42	0.55

Continued on next page...

Continued from previous page...

Atom-1	Atom-2	Interatomic distance (Å)	Clash overlap (Å)
1:B:366:VAL:HG12	1:B:384:LEU:HD11	1.89	0.54
1:A:442:PHE:CZ	1:A:550:ARG:HD2	2.43	0.54
1:B:471:LEU:HD23	1:B:509:PRO:CD	2.37	0.54
1:B:233:THR:HG23	1:B:239:GLN:C	2.28	0.54
1:B:492:ASP:HB2	1:B:493:PRO:HD2	1.90	0.54
1:A:437:ARG:NH2	1:A:441:PRO:HG3	2.22	0.54
1:A:407:LYS:HD3	1:A:526:TRP:CZ2	2.44	0.53
1:A:504:THR:HG22	1:A:508:TRP:HB2	1.90	0.53
1:B:449:LEU:HD21	1:B:460:MET:HE1	1.90	0.53
1:C:320:TYR:OH	1:C:534:VAL:O	2.22	0.53
1:A:284:LEU:HD23	1:A:351:LEU:CD2	2.39	0.52
1:B:485:LEU:HD23	1:B:514:ILE:HB	1.90	0.52
1:A:439:ILE:HG21	1:A:549:SER:OG	2.09	0.52
1:A:453:ILE:HG23	1:A:458:LEU:HB2	1.89	0.52
1:A:286:VAL:CG2	1:A:325:LEU:HD13	2.40	0.52
1:A:424:LEU:HG	1:A:427:VAL:HB	1.91	0.52
1:C:490:ARG:NH1	1:C:496:CYS:HA	2.25	0.52
1:C:514:ILE:HG22	1:C:516:PRO:HD3	1.92	0.52
1:D:407:LYS:HG3	1:D:540:TYR:CZ	2.44	0.52
1:A:545:THR:HG21	1:A:576:LEU:HD22	1.91	0.52
1:A:556:ASN:N	1:A:557:PRO:HD2	2.25	0.51
1:A:424:LEU:HD21	1:A:427:VAL:HG11	1.92	0.51
1:A:433:ILE:HD12	1:A:433:ILE:C	2.31	0.51
1:C:424:LEU:HD23	1:C:427:VAL:HA	1.92	0.51
1:D:212:LEU:HD12	1:D:212:LEU:N	2.24	0.51
1:A:504:THR:HG23	1:A:508:TRP:HE3	1.75	0.51
1:A:459:GLN:HG2	1:A:461:LEU:CD1	2.40	0.51
1:D:261:LEU:HD23	1:D:261:LEU:O	2.11	0.51
1:B:495:SER:HA	1:B:498:LEU:HD12	1.93	0.51
1:C:121:GLU:OE1	1:C:126:HIS:ND1	2.43	0.51
1:D:470:ALA:O	1:D:473:GLU:HB2	2.10	0.51
1:C:434:LEU:HD12	1:C:474:LEU:HD13	1.93	0.51
1:A:391:LEU:HD21	1:A:396:LEU:HD21	1.92	0.50
1:C:359:VAL:HG11	1:C:417:HIS:ND1	2.26	0.50
1:C:280:HIS:ND1	1:C:332:GLU:OE2	2.44	0.50
1:C:474:LEU:O	1:C:477:ARG:N	2.45	0.50
1:C:453:ILE:HD11	1:C:460:MET:CE	2.41	0.50
1:A:290:GLU:OE2	1:B:182:THR:HG23	2.11	0.50
1:A:478:HIS:HB2	1:A:481:LEU:HD12	1.94	0.49
1:D:366:VAL:HG12	1:D:384:LEU:HD11	1.94	0.49
1:C:351:LEU:HD12	1:C:351:LEU:N	2.27	0.49

Continued on next page...

Continued from previous page...

Atom-1	Atom-2	Interatomic distance (Å)	Clash overlap (Å)
1:A:554:VAL:HG22	1:A:555:ARG:N	2.28	0.49
1:B:289:ASP:OD1	1:B:292:SER:OG	2.25	0.49
1:B:471:LEU:HD11	1:B:511:PHE:CE1	2.47	0.49
1:C:142:LEU:HD11	1:C:269:LYS:HB2	1.94	0.49
1:C:197:ASP:OD2	1:C:226:SER:OG	2.13	0.49
1:D:464:GLU:H	1:D:473:GLU:CD	2.15	0.49
1:D:538:ILE:HD12	1:D:538:ILE:H	1.77	0.49
1:D:576:LEU:HD11	1:D:581:GLU:HB2	1.93	0.49
1:C:366:VAL:HG12	1:C:384:LEU:HD11	1.94	0.49
1:D:492:ASP:HB2	1:D:493:PRO:CD	2.43	0.49
1:C:474:LEU:C	1:C:474:LEU:HD23	2.32	0.48
1:A:504:THR:CG2	1:A:508:TRP:HB2	2.43	0.48
1:A:526:TRP:CD2	1:A:574:TYR:HB3	2.48	0.48
1:A:290:GLU:HG2	1:B:181:PRO:HG2	1.95	0.48
1:A:407:LYS:HG3	1:A:540:TYR:CE2	2.49	0.48
1:A:498:LEU:HD13	1:A:518:LEU:HD11	1.95	0.48
1:D:379:LYS:NZ	1:D:524:ASP:OD2	2.43	0.48
1:C:390:SER:CB	1:C:514:ILE:HD13	2.43	0.48
1:C:424:LEU:HD12	1:C:425:PRO:HD2	1.96	0.48
1:D:112:THR:O	1:D:171:THR:HB	2.13	0.48
1:A:367:TYR:CE2	1:A:422:ARG:HB2	2.49	0.48
1:B:584:ASN:OD1	1:B:585:SER:N	2.47	0.48
1:B:293:ILE:HG22	1:B:346:LEU:HD22	1.95	0.48
1:C:280:HIS:CE1	1:C:332:GLU:OE2	2.67	0.48
1:D:423:LYS:HG2	1:D:424:LEU:HD12	1.94	0.48
1:A:442:PHE:CE1	1:A:550:ARG:HD2	2.49	0.47
1:C:366:VAL:HG11	1:C:415:LEU:HD23	1.96	0.47
1:C:341:TYR:O	1:C:345:ARG:HG2	2.15	0.47
1:B:346:LEU:HD12	1:B:351:LEU:HD11	1.96	0.47
1:C:329:SER:HB3	1:C:335:LEU:HD11	1.95	0.47
1:A:228:ARG:NH2	1:D:464:GLU:OE2	2.47	0.47
1:C:397:THR:O	1:C:481:LEU:HD12	2.14	0.47
1:A:504:THR:HG21	1:A:509:PRO:O	2.15	0.47
1:A:329:SER:HB3	1:A:335:LEU:CD1	2.45	0.47
1:B:341:TYR:O	1:B:345:ARG:HG2	2.15	0.47
1:B:442:PHE:HE2	1:B:553:THR:HG21	1.78	0.47
1:C:175:THR:HG21	1:C:187:THR:HG21	1.97	0.47
1:D:142:LEU:HD11	1:D:269:LYS:HB2	1.96	0.47
1:D:333:GLY:O	1:D:336:GLU:HG2	2.15	0.47
1:B:400:CYS:SG	1:B:481:LEU:HD21	2.54	0.47
1:C:469:GLN:O	1:C:473:GLU:HG3	2.14	0.47

Continued on next page...

Continued from previous page...

Atom-1	Atom-2	Interatomic distance (Å)	Clash overlap (Å)
1:C:554:VAL:HG12	1:C:555:ARG:N	2.30	0.47
1:D:424:LEU:HD23	1:D:427:VAL:HG11	1.97	0.47
1:A:284:LEU:HD23	1:A:351:LEU:HD21	1.96	0.46
1:B:294:ALA:HB3	1:B:295:PRO:HD3	1.97	0.46
1:B:351:LEU:N	1:B:351:LEU:HD12	2.30	0.46
1:C:339:LEU:C	1:C:339:LEU:HD23	2.36	0.46
1:D:333:GLY:N	1:D:334:PRO:HD2	2.30	0.46
1:D:495:SER:HA	1:D:498:LEU:HD12	1.96	0.46
1:A:439:ILE:HG21	1:A:549:SER:CB	2.45	0.46
1:C:293:ILE:O	1:C:297:LEU:HG	2.15	0.46
1:A:461:LEU:HD21	1:A:478:HIS:CD2	2.51	0.46
1:C:287:ALA:HA	1:C:321:TYR:HA	1.98	0.46
1:C:461:LEU:CB	1:C:474:LEU:HD11	2.44	0.46
1:D:520:TRP:CE3	1:D:525:ILE:HD13	2.50	0.46
1:A:390:SER:OG	1:A:514:ILE:HD13	2.15	0.46
1:C:360:GLU:OE2	1:C:421:GLN:NE2	2.49	0.45
1:B:433:ILE:HG21	1:B:458:LEU:HD13	1.97	0.45
1:B:327:LEU:HD12	1:B:327:LEU:N	2.31	0.45
1:B:474:LEU:C	1:B:474:LEU:HD23	2.36	0.45
1:D:153:PRO:HD2	1:D:158:THR:HG21	1.99	0.45
1:C:452:THR:HA	1:C:455:ARG:HD2	1.99	0.45
1:A:367:TYR:HE2	1:A:422:ARG:HB2	1.81	0.45
1:B:308:LEU:HD11	1:B:327:LEU:HB3	1.99	0.45
1:C:490:ARG:O	1:C:490:ARG:HG3	2.16	0.45
1:B:362:ALA:HB1	1:B:414:HIS:CE1	2.51	0.45
1:C:433:ILE:HD13	1:C:458:LEU:HD13	1.98	0.45
1:C:329:SER:HB3	1:C:335:LEU:CD1	2.46	0.45
1:B:308:LEU:HD12	1:B:329:SER:HB2	1.98	0.45
1:B:399:LEU:HD23	1:B:483:ALA:HB3	1.98	0.45
1:C:449:LEU:O	1:C:453:ILE:HG13	2.17	0.45
1:A:538:ILE:HD12	1:A:541:ASP:OD2	2.17	0.44
1:B:308:LEU:HD21	1:B:327:LEU:HD23	2.00	0.44
1:C:446:GLU:O	1:C:449:LEU:HG	2.17	0.44
1:A:205:LEU:HD21	1:A:244:PRO:HG2	1.99	0.44
1:B:390:SER:OG	1:B:514:ILE:HG21	2.17	0.44
1:C:152:VAL:HG11	1:C:162:GLU:HG3	2.00	0.44
1:C:538:ILE:HD12	1:C:538:ILE:H	1.82	0.44
1:A:434:LEU:HD12	1:A:474:LEU:CD1	2.47	0.44
1:C:282:LYS:HG3	1:C:335:LEU:HD23	2.00	0.44
1:A:521:THR:HG23	1:A:524:ASP:H	1.83	0.44
1:D:326:THR:HG23	1:D:326:THR:O	2.18	0.44

Continued on next page...

Continued from previous page...

Atom-1	Atom-2	Interatomic distance (Å)	Clash overlap (Å)
1:D:339:LEU:HD23	1:D:339:LEU:O	2.18	0.44
1:B:333:GLY:N	1:B:334:PRO:HD2	2.32	0.44
1:C:245:LEU:HD22	1:C:268:MET:HG2	2.00	0.44
1:A:504:THR:HG23	1:A:508:TRP:CE3	2.53	0.44
1:B:134:PHE:CE2	1:B:265:LEU:HD23	2.53	0.44
1:B:491:THR:HG21	1:B:583:ARG:CZ	2.48	0.44
1:A:376:LEU:HD11	1:A:528:PHE:HB2	2.00	0.43
1:C:118:VAL:HG11	1:C:159:ILE:HD11	1.99	0.43
1:A:502:SER:OG	1:A:513:ARG:NH2	2.51	0.43
1:C:261:LEU:C	1:C:261:LEU:HD23	2.38	0.43
1:A:439:ILE:HG21	1:A:549:SER:HB2	2.00	0.43
1:A:556:ASN:N	1:A:557:PRO:CD	2.81	0.43
1:B:449:LEU:C	1:B:449:LEU:HD23	2.39	0.43
1:C:296:ILE:HD12	1:C:296:ILE:H	1.83	0.43
1:D:134:PHE:CE2	1:D:265:LEU:HD23	2.53	0.43
1:C:290:GLU:HG2	1:D:182:THR:CG2	2.49	0.43
1:B:296:ILE:HD12	1:B:296:ILE:H	1.83	0.43
1:B:310:LEU:C	1:B:310:LEU:HD23	2.39	0.43
1:B:442:PHE:CE2	1:B:553:THR:CG2	3.01	0.43
1:C:400:CYS:SG	1:C:481:LEU:HD21	2.59	0.43
1:C:475:GLN:HG3	1:C:476:ALA:N	2.32	0.43
1:D:432:GLN:OE1	1:D:481:LEU:HD21	2.18	0.43
1:D:351:LEU:N	1:D:351:LEU:HD12	2.33	0.43
1:A:434:LEU:HD12	1:A:474:LEU:HD13	2.00	0.43
1:A:286:VAL:HG21	1:A:325:LEU:HD13	2.01	0.43
1:A:545:THR:CG2	1:A:576:LEU:HD22	2.49	0.43
1:C:326:THR:O	1:C:326:THR:HG23	2.19	0.43
1:A:463:ALA:HB3	1:A:470:ALA:CB	2.49	0.43
1:A:480:GLN:HG3	1:B:397:THR:HG21	2.00	0.43
1:B:434:LEU:C	1:B:434:LEU:HD23	2.40	0.43
1:C:489:ARG:O	1:C:495:SER:CB	2.66	0.42
1:A:501:PHE:C	1:A:512:MET:CE	2.87	0.42
1:A:501:PHE:CE2	1:A:514:ILE:HG12	2.54	0.42
1:B:426:ASP:O	1:B:428:PRO:HD3	2.19	0.42
1:D:424:LEU:HB3	1:D:427:VAL:HG22	2.02	0.42
1:D:466:SER:O	1:D:470:ALA:N	2.35	0.42
1:C:434:LEU:HD23	1:C:434:LEU:C	2.40	0.42
1:B:261:LEU:C	1:B:261:LEU:HD23	2.40	0.42
1:A:480:GLN:HG3	1:B:397:THR:CB	2.49	0.42
1:D:209:THR:HG22	1:D:243:PHE:HZ	1.83	0.42
1:D:286:VAL:CG2	1:D:325:LEU:HD13	2.50	0.42

Continued on next page...

Continued from previous page...

Atom-1	Atom-2	Interatomic distance (Å)	Clash overlap (Å)
1:A:351:LEU:HD12	1:A:351:LEU:N	2.34	0.42
1:D:346:LEU:CD1	1:D:351:LEU:HD11	2.49	0.42
1:A:557:PRO:O	1:A:558:ALA:C	2.58	0.42
1:B:255:PRO:O	1:B:261:LEU:HD12	2.20	0.42
1:B:436:ILE:O	1:B:436:ILE:HG13	2.20	0.42
1:A:461:LEU:HD23	1:A:477:ARG:HD2	2.02	0.42
1:A:501:PHE:HB3	1:A:512:MET:HE2	2.02	0.41
1:C:549:SER:H	1:C:552:ASN:HD22	1.67	0.41
1:A:467:MET:O	1:A:471:LEU:HG	2.20	0.41
1:B:545:THR:HG21	1:B:582:GLU:HA	2.02	0.41
1:C:390:SER:HB3	1:C:514:ILE:HD13	2.02	0.41
1:C:439:ILE:HD13	1:C:549:SER:HA	2.02	0.41
1:B:230:HIS:O	1:B:268:MET:HE1	2.21	0.41
1:D:572:PRO:HD2	1:D:575:LEU:HD12	2.02	0.41
1:D:439:ILE:H	1:D:439:ILE:HD12	1.85	0.41
1:A:363:SER:O	1:A:367:TYR:CD2	2.73	0.41
1:D:310:LEU:C	1:D:310:LEU:HD23	2.41	0.41
1:D:508:TRP:HB3	1:D:509:PRO:CD	2.50	0.41
1:A:134:PHE:CE2	1:A:265:LEU:HD23	2.56	0.41
1:C:467:MET:O	1:C:471:LEU:HB2	2.21	0.41
1:D:313:TYR:HA	1:D:314:PRO:HD3	1.96	0.41
1:A:212:LEU:N	1:A:212:LEU:HD12	2.36	0.41
1:B:438:SER:O	1:B:441:PRO:HD3	2.21	0.41
1:C:121:GLU:OE1	1:C:126:HIS:CB	2.67	0.41
1:C:396:LEU:HD22	1:C:427:VAL:HG21	2.03	0.41
1:C:446:GLU:O	1:C:450:GLN:HG2	2.21	0.41
1:D:329:SER:HB3	1:D:335:LEU:CD1	2.51	0.41
1:D:436:ILE:O	1:D:436:ILE:HG13	2.20	0.41
1:A:461:LEU:CD2	1:A:478:HIS:CD2	3.04	0.41
1:A:461:LEU:HD23	1:A:477:ARG:CD	2.51	0.40
1:B:156:VAL:HG13	1:B:190:ALA:HA	2.02	0.40
1:C:380:VAL:HG12	1:C:384:LEU:HD12	2.03	0.40
1:A:121:GLU:OE1	1:A:126:HIS:CD2	2.74	0.40
1:B:510:ALA:C	1:B:511:PHE:HD1	2.24	0.40
1:A:463:ALA:CB	1:A:470:ALA:HA	2.52	0.40
1:A:502:SER:C	1:A:512:MET:HE1	2.41	0.40
1:D:396:LEU:HD23	1:D:396:LEU:O	2.21	0.40
1:A:530:ARG:HH11	1:A:536:TYR:HE1	1.70	0.40
1:C:124:LYS:NZ	1:D:328:ASP:OD2	2.53	0.40
1:C:313:TYR:OH	1:C:324:LYS:HD2	2.21	0.40
1:C:439:ILE:HB	1:C:549:SER:CB	2.51	0.40

All (2) symmetry-related close contacts are listed below. The label for Atom-2 includes the symmetry operator and encoded unit-cell translations to be applied.

Atom-1	Atom-2	Interatomic distance (Å)	Clash overlap (Å)
1:B:551:GLU:OE2	1:C:171:THR:OG1[1_455]	2.10	0.10
1:A:499:CYS:SG	1:C:499:CYS:HG[2_546]	1.52	0.08

5.3 Torsion angles [i](#)

5.3.1 Protein backbone [i](#)

In the following table, the Percentiles column shows the percent Ramachandran outliers of the chain as a percentile score with respect to all X-ray entries followed by that with respect to entries of similar resolution.

The Analysed column shows the number of residues for which the backbone conformation was analysed, and the total number of residues.

Mol	Chain	Analysed	Favoured	Allowed	Outliers	Percentiles	
1	A	452/482 (94%)	441 (98%)	11 (2%)	0	100	100
1	B	465/482 (96%)	454 (98%)	11 (2%)	0	100	100
1	C	462/482 (96%)	452 (98%)	10 (2%)	0	100	100
1	D	462/482 (96%)	451 (98%)	11 (2%)	0	100	100
All	All	1841/1928 (96%)	1798 (98%)	43 (2%)	0	100	100

There are no Ramachandran outliers to report.

5.3.2 Protein sidechains [i](#)

In the following table, the Percentiles column shows the percent sidechain outliers of the chain as a percentile score with respect to all X-ray entries followed by that with respect to entries of similar resolution.

The Analysed column shows the number of residues for which the sidechain conformation was analysed, and the total number of residues.

Mol	Chain	Analysed	Rotameric	Outliers	Percentiles	
1	A	383/406 (94%)	381 (100%)	2 (0%)	88	96
1	B	396/406 (98%)	395 (100%)	1 (0%)	92	98
1	C	393/406 (97%)	389 (99%)	4 (1%)	76	90

Continued on next page...

Continued from previous page...

Mol	Chain	Analysed	Rotameric	Outliers	Percentiles	
1	D	393/406 (97%)	392 (100%)	1 (0%)	92	98
All	All	1565/1624 (96%)	1557 (100%)	8 (0%)	88	96

All (8) residues with a non-rotameric sidechain are listed below:

Mol	Chain	Res	Type
1	A	312	SER
1	A	427	VAL
1	B	488	THR
1	C	475	GLN
1	C	497	SER
1	C	553	THR
1	C	569	THR
1	D	155	GLU

Sometimes sidechains can be flipped to improve hydrogen bonding and reduce clashes. All (3) such sidechains are listed below:

Mol	Chain	Res	Type
1	A	361	GLN
1	C	432	GLN
1	C	552	ASN

5.3.3 RNA [i](#)

There are no RNA molecules in this entry.

5.4 Non-standard residues in protein, DNA, RNA chains [i](#)

There are no non-standard protein/DNA/RNA residues in this entry.

5.5 Carbohydrates [i](#)

There are no monosaccharides in this entry.

5.6 Ligand geometry [i](#)

There are no ligands in this entry.

5.7 Other polymers [i](#)

There are no such residues in this entry.

5.8 Polymer linkage issues [i](#)

There are no chain breaks in this entry.

6 Fit of model and data [i](#)

6.1 Protein, DNA and RNA chains [i](#)

In the following table, the column labelled ‘#RSRZ > 2’ contains the number (and percentage) of RSRZ outliers, followed by percent RSRZ outliers for the chain as percentile scores relative to all X-ray entries and entries of similar resolution. The OWAB column contains the minimum, median, 95th percentile and maximum values of the occupancy-weighted average B-factor per residue. The column labelled ‘Q < 0.9’ lists the number of (and percentage) of residues with an average occupancy less than 0.9.

Mol	Chain	Analysed	<RSRZ>	#RSRZ>2	OWAB(Å ²)	Q<0.9
1	A	456/482 (94%)	0.52	42 (9%) 9 6	25, 82, 144, 172	0
1	B	469/482 (97%)	0.19	23 (4%) 29 23	31, 68, 115, 147	0
1	C	466/482 (96%)	0.50	52 (11%) 5 3	27, 82, 132, 155	0
1	D	466/482 (96%)	0.21	35 (7%) 14 10	34, 64, 119, 142	0
All	All	1857/1928 (96%)	0.35	152 (8%) 11 8	25, 73, 130, 172	0

All (152) RSRZ outliers are listed below:

Mol	Chain	Res	Type	RSRZ
1	A	491	THR	14.0
1	C	495	SER	9.7
1	C	465	GLY	9.0
1	A	494	TYR	8.8
1	A	467	MET	8.8
1	A	466	SER	7.5
1	D	214	GLY	7.1
1	A	493	PRO	7.1
1	A	465	GLY	6.6
1	A	359	VAL	6.2
1	A	438	SER	6.2
1	C	357	ASN	6.2
1	D	582	GLU	5.9
1	A	542	ARG	5.8
1	A	464	GLU	5.8
1	A	545	THR	5.8
1	C	496	CYS	5.5
1	B	494	TYR	5.4
1	D	210	LYS	5.2
1	A	492	ASP	5.0
1	A	553	THR	5.0

Continued on next page...

Continued from previous page...

Mol	Chain	Res	Type	RSRZ
1	C	497	SER	4.9
1	D	584	ASN	4.8
1	D	481	LEU	4.8
1	C	561	CYS	4.8
1	A	548	GLY	4.6
1	A	479	PRO	4.6
1	A	544	TYR	4.6
1	C	358	ALA	4.6
1	C	490	ARG	4.5
1	A	288	ALA	4.5
1	D	585	SER	4.5
1	D	215	GLU	4.4
1	D	212	LEU	4.4
1	B	493	PRO	4.3
1	C	438	SER	4.3
1	D	583	ARG	4.3
1	D	430	PRO	4.1
1	C	498	LEU	4.1
1	A	437	ARG	4.0
1	B	358	ALA	3.7
1	C	423	LYS	3.7
1	B	467	MET	3.7
1	C	359	VAL	3.7
1	D	211	ALA	3.7
1	D	578	ASN	3.6
1	B	581	GLU	3.5
1	A	495	SER	3.5
1	C	466	SER	3.3
1	A	423	LYS	3.3
1	D	221	SER	3.3
1	A	426	ASP	3.3
1	A	550	ARG	3.3
1	B	583	ARG	3.2
1	D	209	THR	3.2
1	B	346	LEU	3.1
1	C	576	LEU	3.1
1	C	510	ALA	3.1
1	D	581	GLU	3.1
1	B	429	ASN	3.1
1	C	458	LEU	3.1
1	C	360	GLU	3.0
1	C	492	ASP	3.0

Continued on next page...

Continued from previous page...

Mol	Chain	Res	Type	RSRZ
1	C	493	PRO	3.0
1	A	489	ARG	3.0
1	C	434	LEU	2.9
1	B	337	GLU	2.9
1	C	436	ILE	2.9
1	C	474	LEU	2.9
1	D	580	GLU	2.9
1	C	430	PRO	2.9
1	C	522	TYR	2.9
1	D	217	TRP	2.8
1	B	233	THR	2.8
1	B	236	CYS	2.8
1	A	376	LEU	2.8
1	D	577	GLU	2.8
1	D	480	GLN	2.8
1	D	493	PRO	2.8
1	C	467	MET	2.8
1	D	220	LEU	2.8
1	D	474	LEU	2.8
1	D	282	LYS	2.8
1	A	557	PRO	2.7
1	A	509	PRO	2.7
1	C	551	GLU	2.7
1	C	431	LEU	2.7
1	C	494	TYR	2.7
1	D	494	TYR	2.6
1	C	454	LYS	2.6
1	C	439	ILE	2.6
1	D	216	GLY	2.6
1	A	447	GLN	2.6
1	D	213	GLY	2.6
1	D	222	LEU	2.6
1	C	468	LYS	2.5
1	B	431	LEU	2.5
1	B	584	ASN	2.5
1	A	474	LEU	2.5
1	C	449	LEU	2.5
1	B	580	GLU	2.5
1	A	444	GLU	2.5
1	C	509	PRO	2.5
1	C	581	GLU	2.5
1	A	290	GLU	2.5

Continued on next page...

Continued from previous page...

Mol	Chain	Res	Type	RSRZ
1	A	547	LEU	2.5
1	C	517	LEU	2.5
1	B	471	LEU	2.5
1	B	495	SER	2.4
1	C	456	TYR	2.4
1	D	463	ALA	2.4
1	C	445	LEU	2.4
1	C	475	GLN	2.4
1	B	212	LEU	2.4
1	B	423	LYS	2.4
1	C	362	ALA	2.4
1	C	356	PRO	2.4
1	B	577	GLU	2.4
1	C	452	THR	2.3
1	D	431	LEU	2.3
1	C	369	LEU	2.3
1	C	391	LEU	2.3
1	D	218	GLU	2.3
1	D	429	ASN	2.3
1	A	427	VAL	2.3
1	B	215	GLU	2.3
1	D	569	THR	2.3
1	A	496	CYS	2.3
1	A	556	ASN	2.2
1	B	345	ARG	2.2
1	C	464	GLU	2.2
1	A	572	PRO	2.2
1	C	397	THR	2.2
1	A	429	ASN	2.1
1	C	577	GLU	2.1
1	A	471	LEU	2.1
1	A	517	LEU	2.1
1	B	342	LEU	2.1
1	C	471	LEU	2.1
1	B	464	GLU	2.1
1	C	507	GLY	2.1
1	D	205	LEU	2.1
1	D	496	CYS	2.1
1	A	459	GLN	2.1
1	A	543	GLY	2.1
1	C	552	ASN	2.1
1	C	573	ALA	2.0

Continued on next page...

Continued from previous page...

Mol	Chain	Res	Type	RSRZ
1	A	520	TRP	2.0
1	C	361	GLN	2.0
1	C	354	TYR	2.0
1	D	495	SER	2.0
1	A	448	PHE	2.0

6.2 Non-standard residues in protein, DNA, RNA chains [i](#)

There are no non-standard protein/DNA/RNA residues in this entry.

6.3 Carbohydrates [i](#)

There are no monosaccharides in this entry.

6.4 Ligands [i](#)

There are no ligands in this entry.

6.5 Other polymers [i](#)

There are no such residues in this entry.