



Full wwPDB X-ray Structure Validation Report ⓘ

Jan 13, 2024 – 08:17 pm GMT

PDB ID : 6RMW
Title : Structure of N-terminal truncated IMP bound Plasmodium falciparum IMP-nucleotidase
Authors : Carrique, L.; Ballut, L.; Violot, S.; Aghajari, N.
Deposited on : 2019-05-07
Resolution : 3.50 Å(reported)

This is a Full wwPDB X-ray Structure Validation Report for a publicly released PDB entry.

We welcome your comments at validation@mail.wwpdb.org

A user guide is available at

<https://www.wwpdb.org/validation/2017/XrayValidationReportHelp>

with specific help available everywhere you see the ⓘ symbol.

The types of validation reports are described at

<http://www.wwpdb.org/validation/2017/FAQs#types>.

The following versions of software and data (see [references ⓘ](#)) were used in the production of this report:

MolProbity : 4.02b-467
Mogul : 1.8.4, CSD as541be (2020)
Xtriage (Phenix) : 1.13
EDS : 2.36
buster-report : 1.1.7 (2018)
Percentile statistics : 20191225.v01 (using entries in the PDB archive December 25th 2019)
Refmac : 5.8.0158
CCP4 : 7.0.044 (Gargrove)
Ideal geometry (proteins) : Engh & Huber (2001)
Ideal geometry (DNA, RNA) : Parkinson et al. (1996)
Validation Pipeline (wwPDB-VP) : 2.36

1 Overall quality at a glance i

The following experimental techniques were used to determine the structure:

X-RAY DIFFRACTION

The reported resolution of this entry is 3.50 Å.

Percentile scores (ranging between 0-100) for global validation metrics of the entry are shown in the following graphic. The table shows the number of entries on which the scores are based.

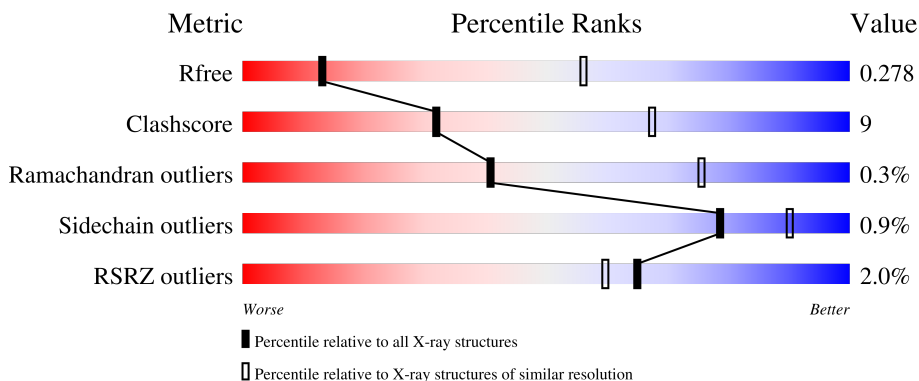



Metric	Whole archive (#Entries)	Similar resolution (#Entries, resolution range(Å))
R_{free}	130704	1659 (3.60-3.40)
Clashscore	141614	1036 (3.58-3.42)
Ramachandran outliers	138981	1005 (3.58-3.42)
Sidechain outliers	138945	1006 (3.58-3.42)
RSRZ outliers	127900	1559 (3.60-3.40)

The table below summarises the geometric issues observed across the polymeric chains and their fit to the electron density. The red, orange, yellow and green segments of the lower bar indicate the fraction of residues that contain outliers for ≥ 3 , 2, 1 and 0 types of geometric quality criteria respectively. A grey segment represents the fraction of residues that are not modelled. The numeric value for each fraction is indicated below the corresponding segment, with a dot representing fractions $\leq 5\%$. The upper red bar (where present) indicates the fraction of residues that have poor fit to the electron density. The numeric value is given above the bar.

Mol	Chain	Length	Quality of chain
1	A	414	 % 67% 22% 10%
1	B	414	 3% 71% 20% 9%
1	C	414	 % 73% 21% 7%
1	D	414	 71% 18% 9%
1	E	414	 % 74% 17% 9%

Continued on next page...

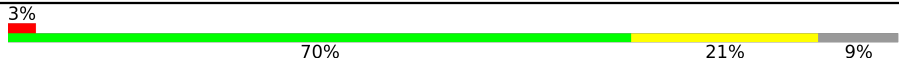
Continued from previous page...

Mol	Chain	Length	Quality of chain
1	F	414	 3% 70% 21% 9%
1	G	414	 3% 69% 21% 10%
1	H	414	 2% 74% 16% 9%

2 Entry composition

There are 4 unique types of molecules in this entry. The entry contains 23618 atoms, of which 0 are hydrogens and 0 are deuteriums.

In the tables below, the ZeroOcc column contains the number of atoms modelled with zero occupancy, the AltConf column contains the number of residues with at least one atom in alternate conformation and the Trace column contains the number of residues modelled with at most 2 atoms.

- Molecule 1 is a protein called IMP-specific 5'-nucleotidase, putative.

Mol	Chain	Residues	Atoms					ZeroOcc	AltConf	Trace
			Total	C	N	O	S			
1	A	374	Total 2876	C 1859	N 475	O 526	S 16	0	0	0
1	B	375	Total 2906	C 1871	N 478	O 541	S 16	0	0	0
1	C	386	Total 3040	C 1963	N 496	O 565	S 16	0	0	0
1	D	375	Total 3009	C 1942	N 501	O 551	S 15	0	0	0
1	E	377	Total 2969	C 1917	N 487	O 550	S 15	0	0	0
1	F	378	Total 2938	C 1903	N 477	O 542	S 16	0	0	0
1	G	371	Total 2793	C 1796	N 461	O 521	S 15	0	0	0
1	H	375	Total 2883	C 1854	N 477	O 536	S 16	0	0	0

There are 8 discrepancies between the modelled and reference sequences:

Chain	Residue	Modelled	Actual	Comment	Reference
A	172	ASN	ASP	engineered mutation	UNP A0A144A134
B	172	ASN	ASP	engineered mutation	UNP A0A144A134
C	172	ASN	ASP	engineered mutation	UNP A0A144A134
D	172	ASN	ASP	engineered mutation	UNP A0A144A134
E	172	ASN	ASP	engineered mutation	UNP A0A144A134
F	172	ASN	ASP	engineered mutation	UNP A0A144A134
G	172	ASN	ASP	engineered mutation	UNP A0A144A134
H	172	ASN	ASP	engineered mutation	UNP A0A144A134

- Molecule 2 is INOSINIC ACID (three-letter code: IMP) (formula: C₁₀H₁₃N₄O₈P).

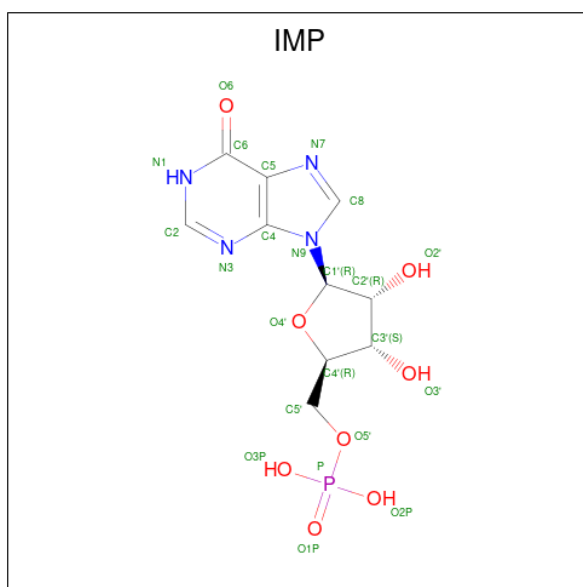

Mol	Chain	Residues	Atoms					ZeroOcc	AltConf
			Total	C	N	O	P		
2	A	1	Total	C	N	O	P	0	0
			23	10	4	8	1		
2	B	1	Total	C	N	O	P	0	0
			23	10	4	8	1		
2	C	1	Total	C	N	O	P	0	0
			23	10	4	8	1		
2	D	1	Total	C	N	O	P	0	0
			23	10	4	8	1		
2	E	1	Total	C	N	O	P	0	0
			23	10	4	8	1		
2	F	1	Total	C	N	O	P	0	0
			23	10	4	8	1		
2	G	1	Total	C	N	O	P	0	0
			23	10	4	8	1		
2	H	1	Total	C	N	O	P	0	0
			23	10	4	8	1		

- Molecule 3 is MAGNESIUM ION (three-letter code: MG) (formula: Mg).

Mol	Chain	Residues	Atoms		ZeroOcc	AltConf
			Total	Mg		
3	A	1	Total	Mg	0	0
			1	1		
3	B	1	Total	Mg	0	0
			1	1		
3	C	1	Total	Mg	0	0
			1	1		
3	D	1	Total	Mg	0	0
			1	1		

Continued on next page...

Continued from previous page...

Mol	Chain	Residues	Atoms	ZeroOcc	AltConf
3	E	1	Total Mg 1 1	0	0
3	F	1	Total Mg 1 1	0	0
3	G	1	Total Mg 1 1	0	0
3	H	1	Total Mg 1 1	0	0

- Molecule 4 is GLYCEROL (three-letter code: GOL) (formula: C₃H₈O₃).

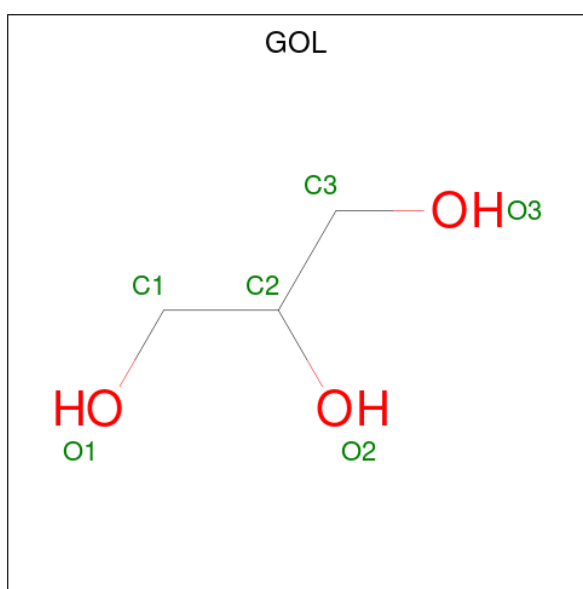

Mol	Chain	Residues	Atoms	ZeroOcc	AltConf
4	D	1	Total C O 6 3 3	0	0
4	E	1	Total C O 6 3 3	0	0

3 Residue-property plots

These plots are drawn for all protein, RNA, DNA and oligosaccharide chains in the entry. The first graphic for a chain summarises the proportions of the various outlier classes displayed in the second graphic. The second graphic shows the sequence view annotated by issues in geometry and electron density. Residues are color-coded according to the number of geometric quality criteria for which they contain at least one outlier: green = 0, yellow = 1, orange = 2 and red = 3 or more. A red dot above a residue indicates a poor fit to the electron density ($RSRZ > 2$). Stretches of 2 or more consecutive residues without any outlier are shown as a green connector. Residues present in the sample, but not in the model, are shown in grey.

- Molecule 1: IMP-specific 5'-nucleotidase, putative

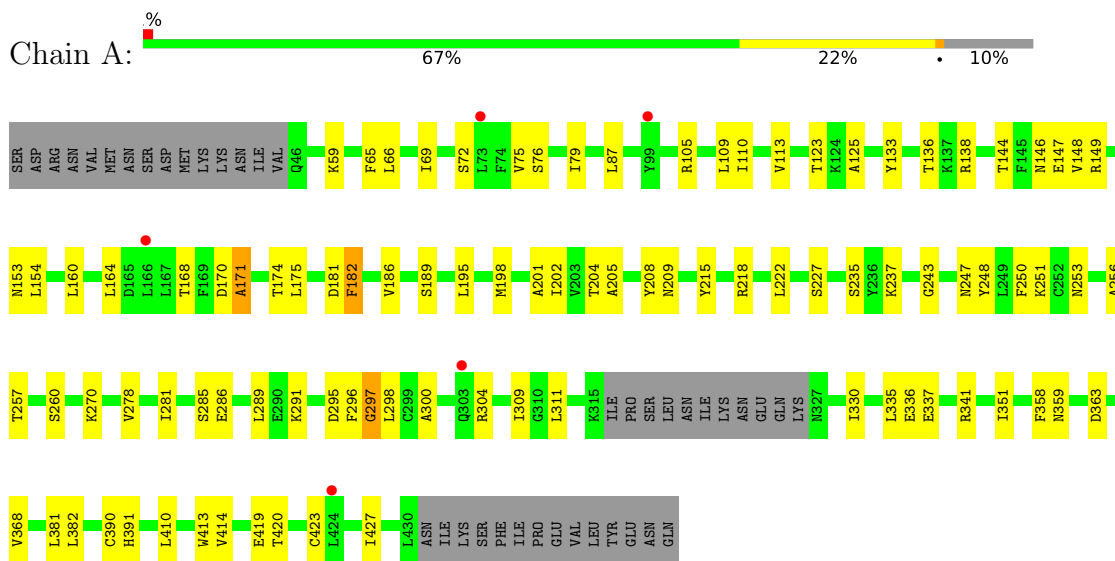

- Molecule 1: IMP-specific 5'-nucleotidase, putative

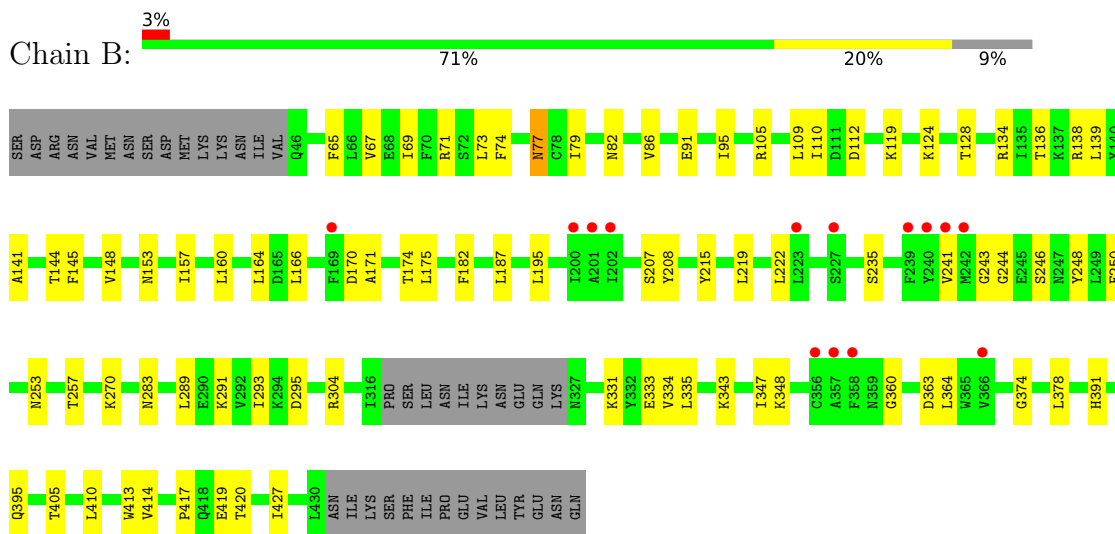

- Molecule 1: IMP-specific 5'-nucleotidase, putative



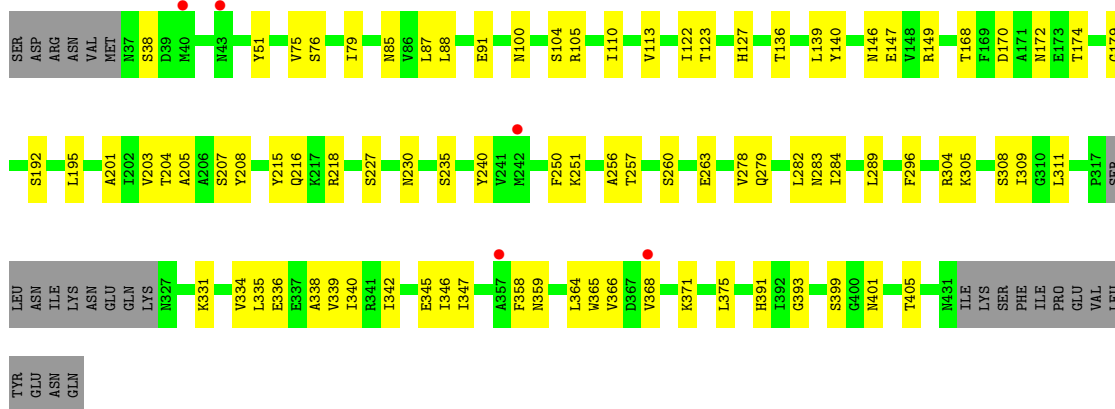

• Molecule 1: IMP-specific 5'-nucleotidase, putative

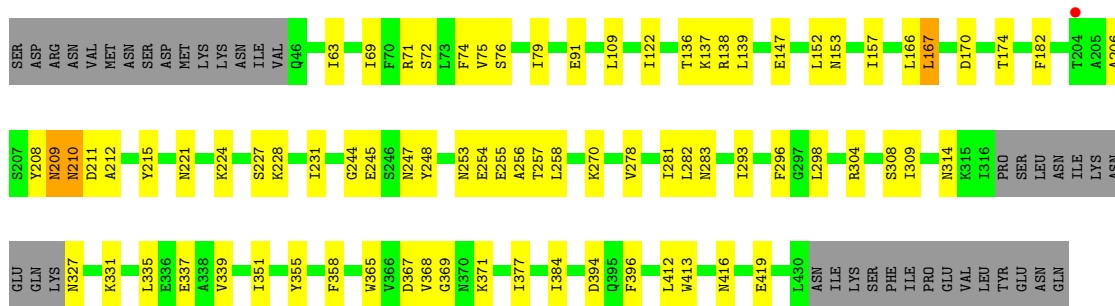
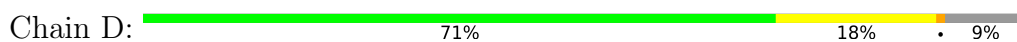

• Molecule 1: IMP-specific 5'-nucleotidase, putative

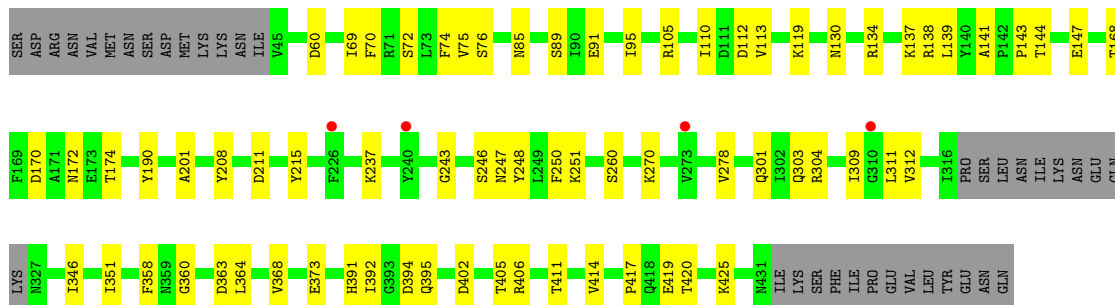
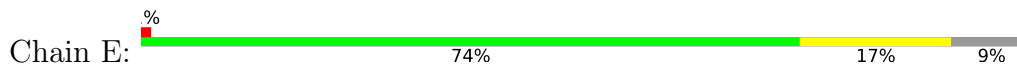

• Molecule 1: IMP-specific 5'-nucleotidase, putative



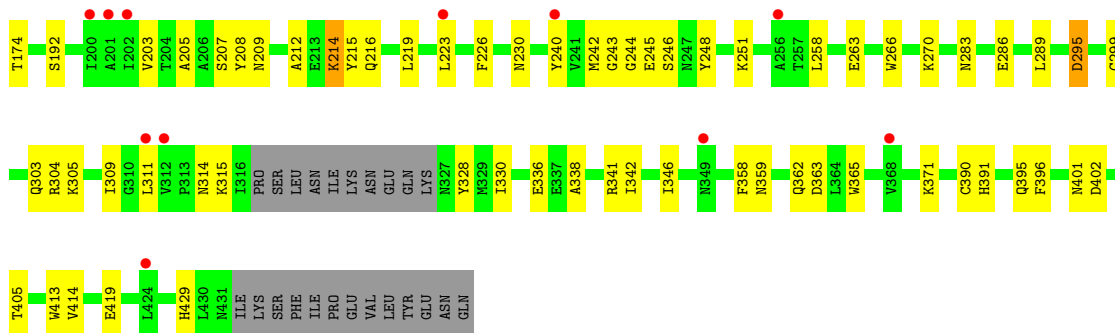

- Molecule 1: IMP-specific 5'-nucleotidase, putative

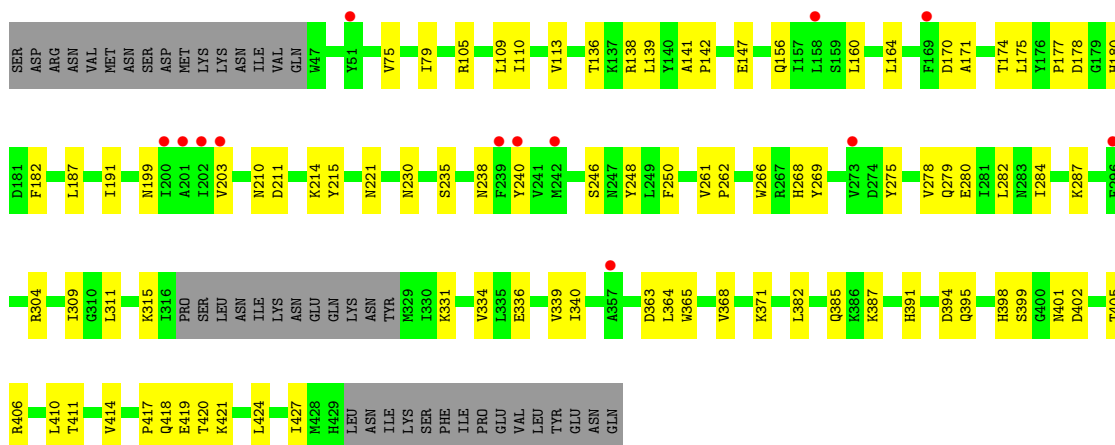

- Molecule 1: IMP-specific 5'-nucleotidase, putative

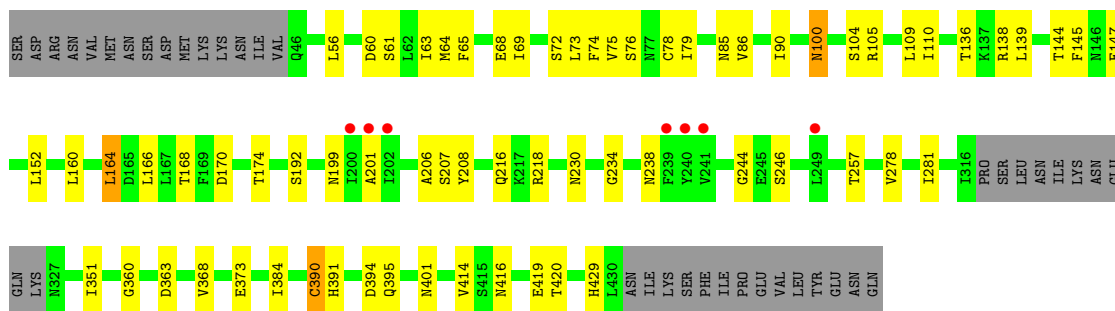
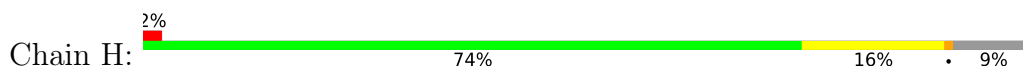

4 Data and refinement statistics

Property	Value	Source
Space group	P 1 21 1	Depositor
Cell constants a, b, c, α , β , γ	107.80Å 203.90Å 115.30Å 90.00° 113.40° 90.00°	Depositor
Resolution (Å)	48.07 – 3.50 48.07 – 3.50	Depositor EDS
% Data completeness (in resolution range)	99.1 (48.07-3.50) 99.2 (48.07-3.50)	Depositor EDS
R_{merge}	(Not available)	Depositor
R_{sym}	(Not available)	Depositor
$\langle I/\sigma(I) \rangle$ ¹	1.00 (at 3.48Å)	Xtrriage
Refinement program	PHENIX (1.16_3549: ???)	Depositor
R, R_{free}	0.236 , 0.279 0.237 , 0.278	Depositor DCC
R_{free} test set	2851 reflections (5.00%)	wwPDB-VP
Wilson B-factor (Å ²)	135.4	Xtrriage
Anisotropy	0.190	Xtrriage
Bulk solvent k_{sol} (e/Å ³), B_{sol} (Å ²)	0.27 , 79.1	EDS
L-test for twinning ²	$\langle L \rangle = 0.39$, $\langle L^2 \rangle = 0.22$	Xtrriage
Estimated twinning fraction	No twinning to report.	Xtrriage
F_o, F_c correlation	0.93	EDS
Total number of atoms	23618	wwPDB-VP
Average B, all atoms (Å ²)	140.0	wwPDB-VP

Xtrriage's analysis on translational NCS is as follows: *The largest off-origin peak in the Patterson function is 11.81% of the height of the origin peak. No significant pseudotranslation is detected.*

¹Intensities estimated from amplitudes.

²Theoretical values of $\langle |L| \rangle$, $\langle L^2 \rangle$ for acentric reflections are 0.5, 0.333 respectively for untwinned datasets, and 0.375, 0.2 for perfectly twinned datasets.

5 Model quality [i](#)

5.1 Standard geometry [i](#)

Bond lengths and bond angles in the following residue types are not validated in this section: GOL, MG, IMP

The Z score for a bond length (or angle) is the number of standard deviations the observed value is removed from the expected value. A bond length (or angle) with $|Z| > 5$ is considered an outlier worth inspection. RMSZ is the root-mean-square of all Z scores of the bond lengths (or angles).

Mol	Chain	Bond lengths		Bond angles	
		RMSZ	# Z >5	RMSZ	# Z >5
1	A	0.24	0/2939	0.41	0/4001
1	B	0.24	0/2966	0.41	0/4030
1	C	0.24	0/3107	0.40	0/4219
1	D	0.24	0/3073	0.39	0/4158
1	E	0.24	0/3031	0.39	0/4109
1	F	0.24	0/3003	0.41	0/4083
1	G	0.24	0/2853	0.41	0/3890
1	H	0.24	0/2944	0.41	0/4007
All	All	0.24	0/23916	0.41	0/32497

There are no bond length outliers.

There are no bond angle outliers.

There are no chirality outliers.

There are no planarity outliers.

5.2 Too-close contacts [i](#)

In the following table, the Non-H and H(model) columns list the number of non-hydrogen atoms and hydrogen atoms in the chain respectively. The H(added) column lists the number of hydrogen atoms added and optimized by MolProbity. The Clashes column lists the number of clashes within the asymmetric unit, whereas Symm-Clashes lists symmetry-related clashes.

Mol	Chain	Non-H	H(model)	H(added)	Clashes	Symm-Clashes
1	A	2876	0	2694	69	0
1	B	2906	0	2754	54	0
1	C	3040	0	2901	59	0
1	D	3009	0	2958	59	0
1	E	2969	0	2866	50	0

Continued on next page...

Continued from previous page...

Mol	Chain	Non-H	H(model)	H(added)	Clashes	Symm-Clashes
1	F	2938	0	2777	55	0
1	G	2793	0	2556	54	0
1	H	2883	0	2686	47	0
2	A	23	0	11	2	0
2	B	23	0	11	0	0
2	C	23	0	11	5	0
2	D	23	0	11	3	0
2	E	23	0	11	2	0
2	F	23	0	10	1	0
2	G	23	0	11	1	0
2	H	23	0	11	2	0
3	A	1	0	0	0	0
3	B	1	0	0	0	0
3	C	1	0	0	0	0
3	D	1	0	0	0	0
3	E	1	0	0	0	0
3	F	1	0	0	0	0
3	G	1	0	0	0	0
3	H	1	0	0	0	0
4	D	6	0	8	1	0
4	E	6	0	8	0	0
All	All	23618	0	22295	410	0

The all-atom clashscore is defined as the number of clashes found per 1000 atoms (including hydrogen atoms). The all-atom clashscore for this structure is 9.

All (410) close contacts within the same asymmetric unit are listed below, sorted by their clash magnitude.

Atom-1	Atom-2	Interatomic distance (Å)	Clash overlap (Å)
1:D:253:ASN:OD1	1:D:254:GLU:OE1	1.66	1.13
1:B:82:ASN:O	1:C:85:ASN:ND2	2.12	0.83
1:H:414:VAL:HG23	1:H:419:GLU:HB2	1.65	0.78
1:H:170:ASP:O	1:H:174:THR:OG1	2.02	0.76
1:B:414:VAL:HG23	1:B:419:GLU:HB2	1.69	0.74
1:G:160:LEU:HD13	1:G:164:LEU:HD13	1.70	0.74
1:C:168:THR:HG22	1:C:201:ALA:HB3	1.70	0.74
1:C:205:ALA:HB2	1:C:401:ASN:HD21	1.54	0.73
1:B:67:VAL:HG12	1:B:71:ARG:HD2	1.71	0.72
1:E:105:ARG:NH2	1:H:74:PHE:O	2.23	0.72
1:E:278:VAL:HG22	1:E:368:VAL:HG11	1.72	0.71
1:F:205:ALA:HB3	2:F:501:IMP:H5'2	1.72	0.71

Continued on next page...

Continued from previous page...

Atom-1	Atom-2	Interatomic distance (Å)	Clash overlap (Å)
1:D:358:PHE:HZ	2:D:501:IMP:H8	1.56	0.71
1:F:105:ARG:NH1	1:G:139:LEU:O	2.24	0.70
1:F:139:LEU:O	1:G:105:ARG:NH1	2.25	0.70
1:B:105:ARG:NH1	1:C:139:LEU:O	2.24	0.70
1:D:283:ASN:OD1	1:D:304:ARG:NH2	2.25	0.70
1:A:289:LEU:HD12	1:A:311:LEU:HD23	1.75	0.69
1:G:406:ARG:HG2	1:G:411:THR:HG21	1.75	0.69
1:G:414:VAL:HG11	1:G:420:THR:HG23	1.73	0.69
1:A:285:SER:HB2	1:A:309:ILE:HD11	1.72	0.69
1:G:230:ASN:ND2	1:G:235:SER:OG	2.25	0.69
1:C:358:PHE:HZ	2:C:501:IMP:H8	1.58	0.68
1:E:237:LYS:O	1:E:251:LYS:NZ	2.26	0.68
1:H:414:VAL:HG21	1:H:420:THR:HG23	1.75	0.68
1:E:278:VAL:HG13	1:E:368:VAL:HG21	1.75	0.68
1:A:358:PHE:HZ	2:A:501:IMP:H8	1.58	0.68
1:G:170:ASP:O	1:G:174:THR:OG1	2.11	0.68
1:H:138:ARG:NH2	1:H:147:GLU:OE2	2.27	0.67
1:A:75:VAL:HG13	1:D:109:LEU:HD13	1.76	0.67
1:B:414:VAL:HG21	1:B:420:THR:HG23	1.76	0.67
1:D:79:ILE:HG13	1:D:136:THR:HG23	1.76	0.67
1:F:395:GLN:HE21	1:F:401:ASN:H	1.42	0.67
1:F:289:LEU:HD22	1:F:311:LEU:HD12	1.77	0.67
1:G:156:GLN:NE2	1:G:411:THR:O	2.27	0.67
1:A:296:PHE:HA	1:B:134:ARG:HD2	1.76	0.66
1:A:168:THR:HG22	1:A:201:ALA:HB3	1.76	0.66
1:E:414:VAL:HG11	1:E:420:THR:HG23	1.76	0.66
1:A:247:ASN:OD1	1:A:270:LYS:NZ	2.29	0.66
1:D:138:ARG:NH2	1:D:147:GLU:OE2	2.28	0.66
1:H:216:GLN:HE22	1:H:257:THR:HA	1.61	0.66
1:G:110:ILE:HG13	1:G:113:VAL:HG22	1.77	0.65
1:F:170:ASP:O	1:F:174:THR:OG1	2.11	0.65
1:B:74:PHE:O	1:C:105:ARG:NH2	2.29	0.65
1:B:253:ASN:ND2	1:B:257:THR:O	2.29	0.65
1:E:406:ARG:HG2	1:E:411:THR:HG21	1.79	0.64
1:G:385:GLN:OE1	1:G:387:LYS:NZ	2.30	0.64
1:A:237:LYS:O	1:A:251:LYS:NZ	2.30	0.64
1:B:170:ASP:O	1:B:174:THR:OG1	2.13	0.64
1:C:216:GLN:HE22	1:C:257:THR:HA	1.63	0.63
1:D:314:ASN:O	1:D:327:ASN:N	2.31	0.63
1:B:182:PHE:HB3	1:B:219:LEU:HA	1.79	0.63
1:E:247:ASN:OD1	1:E:270:LYS:NZ	2.32	0.63

Continued on next page...

Continued from previous page...

Atom-1	Atom-2	Interatomic distance (Å)	Clash overlap (Å)
1:H:395:GLN:OE1	1:H:401:ASN:ND2	2.31	0.63
1:C:88:LEU:HD23	1:C:123:THR:HG21	1.81	0.63
1:C:170:ASP:O	1:C:174:THR:OG1	2.13	0.62
1:E:74:PHE:O	1:H:105:ARG:NH2	2.32	0.62
1:C:91:GLU:HG3	1:C:122:ILE:HG22	1.80	0.62
1:A:298:LEU:CD1	1:A:300:ALA:HB3	2.29	0.62
1:F:414:VAL:HG13	1:F:419:GLU:HB2	1.82	0.62
1:C:401:ASN:ND2	2:C:501:IMP:O2P	2.31	0.62
1:C:309:ILE:HG22	1:C:366:VAL:HG22	1.82	0.61
1:D:212:ALA:HB1	1:D:258:LEU:HB2	1.82	0.61
1:D:209:ASN:HA	1:D:248:TYR:HE2	1.65	0.61
1:A:138:ARG:NH2	1:A:147:GLU:OE1	2.34	0.61
1:C:147:GLU:OE1	1:D:331:LYS:NZ	2.33	0.61
1:E:246:SER:OG	1:E:373:GLU:OE2	2.19	0.61
1:E:137:LYS:HD3	1:F:295:ASP:HB3	1.83	0.61
1:C:279:GLN:OE1	1:C:304:ARG:NH2	2.35	0.60
1:E:172:ASN:HB2	2:E:501:IMP:O3P	2.01	0.60
1:C:208:TYR:HB2	1:C:215:TYR:CE1	2.36	0.60
1:C:283:ASN:OD1	1:C:304:ARG:NH1	2.33	0.60
1:G:336:GLU:OE1	1:G:399:SER:OG	2.20	0.60
1:H:168:THR:HG22	1:H:201:ALA:HB3	1.82	0.60
1:F:216:GLN:HG3	1:F:223:LEU:HD13	1.83	0.59
1:F:402:ASP:O	1:F:405:THR:OG1	2.20	0.59
1:G:282:LEU:HD12	1:G:309:ILE:HG12	1.84	0.59
1:B:283:ASN:OD1	1:B:304:ARG:NH2	2.35	0.59
1:C:195:LEU:HG	1:C:235:SER:HB2	1.83	0.59
1:A:298:LEU:C	1:A:298:LEU:HD12	2.23	0.59
1:B:207:SER:HB2	1:B:244:GLY:HA2	1.84	0.59
1:E:170:ASP:O	1:E:174:THR:OG1	2.20	0.59
1:A:330:ILE:HD12	1:A:335:LEU:HD21	1.85	0.59
1:G:210:ASN:HA	1:G:250:PHE:HZ	1.68	0.59
1:H:363:ASP:OD2	2:H:501:IMP:O2'	2.20	0.59
1:H:281:ILE:HD11	1:H:351:ILE:HG21	1.83	0.59
1:E:243:GLY:N	1:E:248:TYR:O	2.35	0.59
1:F:79:ILE:HG12	1:F:136:THR:HG23	1.83	0.59
1:A:146:ASN:OD1	1:A:149:ARG:NH2	2.36	0.58
1:F:109:LEU:HD13	1:G:75:VAL:HG13	1.84	0.58
1:E:75:VAL:HG23	1:H:109:LEU:HD22	1.85	0.58
1:B:195:LEU:HG	1:B:235:SER:HB2	1.84	0.58
1:C:358:PHE:CZ	2:C:501:IMP:H8	2.38	0.58
1:C:305:LYS:HB2	1:C:308:SER:HB2	1.84	0.58

Continued on next page...

Continued from previous page...

Atom-1	Atom-2	Interatomic distance (Å)	Clash overlap (Å)
1:C:331:LYS:HB2	1:C:334:VAL:HG12	1.83	0.58
1:F:263:GLU:OE2	1:F:263:GLU:N	2.32	0.58
1:E:139:LEU:O	1:H:105:ARG:NH1	2.37	0.58
1:C:79:ILE:HG12	1:C:136:THR:HG23	1.86	0.58
1:C:282:LEU:HD12	1:C:309:ILE:HB	1.86	0.58
1:G:138:ARG:NH1	1:G:141:ALA:O	2.37	0.58
1:H:79:ILE:HG12	1:H:136:THR:HG23	1.86	0.58
1:C:123:THR:O	1:C:127:HIS:ND1	2.34	0.57
1:A:69:ILE:HD13	1:D:76:SER:HB3	1.85	0.57
1:E:208:TYR:HB2	1:E:215:TYR:CE1	2.39	0.57
1:C:192:SER:HB2	1:C:230:ASN:HD21	1.69	0.57
1:H:192:SER:OG	1:H:230:ASN:OD1	2.20	0.57
1:A:109:LEU:HD13	1:D:75:VAL:HG13	1.87	0.57
1:E:190:TYR:HE2	1:E:425:LYS:HB2	1.70	0.57
1:E:105:ARG:NH1	1:H:139:LEU:O	2.38	0.57
1:H:360:GLY:HA2	1:H:395:GLN:HE22	1.69	0.57
1:B:153:ASN:ND2	1:B:413:TRP:O	2.37	0.57
1:B:289:LEU:O	1:B:293:ILE:HG12	2.05	0.57
1:C:140:TYR:N	1:D:337:GLU:OE1	2.31	0.56
1:E:168:THR:OG1	1:E:391:HIS:ND1	2.31	0.56
1:E:76:SER:HB3	1:H:69:ILE:HD13	1.88	0.56
1:H:174:THR:HG22	1:H:394:ASP:HB3	1.87	0.56
1:D:170:ASP:O	1:D:174:THR:OG1	2.14	0.56
1:E:250:PHE:HD1	1:E:260:SER:HA	1.68	0.56
1:F:336:GLU:OE1	1:F:359:ASN:ND2	2.36	0.56
1:G:331:LYS:HB2	1:G:334:VAL:HG12	1.88	0.56
1:E:144:THR:HB	1:E:147:GLU:HG3	1.86	0.56
1:F:170:ASP:OD2	1:F:371:LYS:NZ	2.37	0.56
1:H:208:TYR:OH	1:H:218:ARG:NH1	2.39	0.56
1:B:171:ALA:HA	1:B:175:LEU:HD12	1.89	0.55
1:C:346:ILE:HG22	1:C:347:ILE:HD12	1.86	0.55
1:G:279:GLN:OE1	1:G:304:ARG:NH2	2.40	0.55
1:A:110:ILE:HB	1:A:113:VAL:HG13	1.89	0.55
1:C:207:SER:O	1:C:305:LYS:NZ	2.35	0.55
1:B:69:ILE:HD13	1:C:76:SER:HB3	1.89	0.55
1:D:91:GLU:HG3	1:D:122:ILE:HG22	1.88	0.55
1:H:73:LEU:HD11	1:H:86:VAL:HG11	1.88	0.54
1:B:243:GLY:N	1:B:248:TYR:O	2.34	0.54
1:E:72:SER:HA	1:E:75:VAL:HG12	1.89	0.54
1:E:311:LEU:HB3	1:E:364:LEU:HB3	1.89	0.54
1:A:87:LEU:HB3	1:A:123:THR:HG22	1.90	0.54

Continued on next page...

Continued from previous page...

Atom-1	Atom-2	Interatomic distance (Å)	Clash overlap (Å)
1:C:358:PHE:HE1	1:C:365:TRP:HB2	1.73	0.54
1:A:208:TYR:HB2	1:A:215:TYR:CZ	2.42	0.54
1:C:208:TYR:OH	1:C:218:ARG:NH2	2.41	0.54
1:G:339:VAL:HG23	1:G:340:ILE:HD12	1.88	0.54
1:B:208:TYR:HB2	1:B:215:TYR:HE1	1.73	0.54
1:E:138:ARG:NH1	1:E:141:ALA:O	2.41	0.54
1:A:182:PHE:HE2	1:A:222:LEU:HD13	1.72	0.54
1:G:363:ASP:N	1:G:363:ASP:OD1	2.40	0.54
1:H:429:HIS:O	1:H:429:HIS:ND1	2.37	0.54
1:B:79:ILE:HG13	1:B:136:THR:HG23	1.90	0.53
1:F:153:ASN:ND2	1:F:413:TRP:O	2.41	0.53
1:G:278:VAL:HG12	1:G:368:VAL:HG11	1.89	0.53
1:A:144:THR:HG22	1:A:146:ASN:H	1.73	0.53
1:F:73:LEU:HD11	1:F:86:VAL:HG11	1.90	0.53
1:B:124:LYS:O	1:B:128:THR:HG22	2.08	0.53
1:E:69:ILE:HD13	1:H:76:SER:HB3	1.90	0.53
1:H:394:ASP:OD1	1:H:395:GLN:N	2.41	0.53
1:G:417:PRO:O	1:G:420:THR:OG1	2.25	0.53
1:G:424:LEU:HD23	1:G:427:ILE:HD12	1.91	0.53
1:A:297:GLY:H	1:B:134:ARG:HD2	1.74	0.53
1:A:160:LEU:HD13	1:A:164:LEU:HD22	1.92	0.52
1:B:73:LEU:HD11	1:B:86:VAL:HG11	1.90	0.52
1:D:206:ALA:O	1:D:244:GLY:N	2.34	0.52
1:A:337:GLU:HG3	1:A:341:ARG:HD2	1.91	0.52
1:A:76:SER:HB3	1:D:69:ILE:HD13	1.90	0.52
1:E:70:PHE:HB3	1:E:143:PRO:HG2	1.92	0.52
1:B:139:LEU:O	1:C:105:ARG:NH1	2.42	0.52
1:D:210:ASN:O	1:D:210:ASN:ND2	2.40	0.52
1:G:182:PHE:O	1:G:221:ASN:HB3	2.10	0.52
1:C:339:VAL:HG11	1:C:399:SER:HB2	1.92	0.52
1:B:360:GLY:HA2	1:B:395:GLN:HE22	1.75	0.52
1:F:330:ILE:HD11	1:F:362:GLN:HA	1.90	0.52
1:A:79:ILE:HG13	1:A:136:THR:HG23	1.90	0.52
1:D:153:ASN:ND2	1:D:413:TRP:O	2.41	0.52
1:F:167:LEU:HD23	1:F:390:CYS:HB3	1.92	0.52
1:D:227:SER:HB3	1:D:256:ALA:HB2	1.90	0.52
1:G:171:ALA:HA	1:G:175:LEU:HD12	1.93	0.51
1:E:417:PRO:O	1:E:420:THR:OG1	2.28	0.51
1:H:230:ASN:HA	1:H:234:GLY:HA3	1.91	0.51
1:B:138:ARG:HD2	1:B:141:ALA:HB3	1.92	0.51
1:H:60:ASP:OD1	1:H:61:SER:N	2.43	0.51

Continued on next page...

Continued from previous page...

Atom-1	Atom-2	Interatomic distance (Å)	Clash overlap (Å)
1:A:153:ASN:ND2	1:A:413:TRP:O	2.43	0.51
1:B:219:LEU:HD13	1:B:222:LEU:HD23	1.92	0.51
1:E:346:ILE:HG23	1:E:351:ILE:HD12	1.92	0.51
1:F:245:GLU:HG2	1:F:371:LYS:HG2	1.92	0.51
1:B:157:ILE:HG23	1:B:427:ILE:HG13	1.91	0.51
1:D:253:ASN:OD1	1:D:254:GLU:N	2.43	0.51
1:C:289:LEU:HD12	1:C:311:LEU:HG	1.92	0.51
1:H:69:ILE:HG21	1:H:90:ILE:HD11	1.92	0.51
1:B:109:LEU:HD13	1:C:75:VAL:HG13	1.92	0.50
1:D:166:LEU:HB2	1:D:384:ILE:HD13	1.93	0.50
1:A:227:SER:HB3	1:A:256:ALA:HB2	1.93	0.50
1:D:247:ASN:C	1:D:248:TYR:HD1	2.15	0.50
1:G:79:ILE:HG12	1:G:136:THR:HG23	1.93	0.50
1:C:250:PHE:HD1	1:C:260:SER:HA	1.76	0.50
1:H:390:CYS:SG	1:H:391:HIS:N	2.85	0.50
1:D:293:ILE:HA	1:D:298:LEU:HB2	1.92	0.50
1:D:296:PHE:HB2	1:D:298:LEU:HD13	1.93	0.50
1:H:278:VAL:HB	1:H:368:VAL:HG21	1.94	0.50
1:F:205:ALA:HA	1:F:244:GLY:O	2.12	0.50
1:A:304:ARG:HA	1:A:309:ILE:HG22	1.94	0.50
1:G:398:HIS:O	1:G:399:SER:OG	2.29	0.50
1:A:170:ASP:O	1:A:174:THR:HB	2.12	0.49
1:A:243:GLY:N	1:A:248:TYR:O	2.33	0.49
1:C:110:ILE:HB	1:C:113:VAL:HG22	1.95	0.49
1:D:355:TYR:HA	1:D:369:GLY:H	1.77	0.49
1:H:72:SER:HA	1:H:75:VAL:HG22	1.94	0.49
1:H:166:LEU:HB2	1:H:384:ILE:HD13	1.94	0.49
1:A:298:LEU:HD13	1:A:300:ALA:HB3	1.95	0.49
1:B:95:ILE:HD12	1:B:119:LYS:HD2	1.94	0.49
1:C:170:ASP:HB3	1:C:393:GLY:HA2	1.95	0.49
1:E:60:ASP:OD2	1:E:406:ARG:NH1	2.31	0.49
1:C:289:LEU:HD11	1:C:364:LEU:HD22	1.93	0.49
1:A:181:ASP:OD1	1:A:218:ARG:NH1	2.45	0.49
1:D:208:TYR:O	1:D:210:ASN:N	2.43	0.49
1:F:74:PHE:O	1:G:105:ARG:NH2	2.46	0.49
1:F:91:GLU:O	1:F:95:ILE:HG12	2.12	0.49
1:G:261:VAL:HG22	1:G:262:PRO:HD2	1.95	0.48
1:G:414:VAL:HG13	1:G:419:GLU:HB3	1.95	0.48
1:A:133:TYR:CD2	1:B:331:LYS:HD2	2.47	0.48
1:A:414:VAL:HG13	1:A:419:GLU:HB2	1.95	0.48
1:D:174:THR:HG22	1:D:394:ASP:HB3	1.95	0.48

Continued on next page...

Continued from previous page...

Atom-1	Atom-2	Interatomic distance (Å)	Clash overlap (Å)
1:E:246:SER:OG	1:E:246:SER:O	2.31	0.48
1:B:253:ASN:HD21	1:B:257:THR:HB	1.79	0.48
1:F:212:ALA:HB1	1:F:258:LEU:HD12	1.95	0.48
1:A:209:ASN:HA	1:A:248:TYR:CZ	2.48	0.48
1:B:363:ASP:N	1:B:363:ASP:OD1	2.46	0.48
1:E:75:VAL:HG22	1:H:65:PHE:HE1	1.77	0.48
1:F:203:VAL:HA	1:F:242:MET:HB3	1.96	0.48
1:D:63:ILE:HG12	1:D:152:LEU:HD12	1.95	0.48
1:F:283:ASN:OD1	1:F:304:ARG:NH2	2.30	0.48
1:G:210:ASN:HA	1:G:250:PHE:CZ	2.48	0.48
1:A:160:LEU:HD21	1:A:410:LEU:HD12	1.96	0.47
1:A:250:PHE:HD1	1:A:260:SER:HA	1.79	0.47
1:E:110:ILE:HB	1:E:113:VAL:HG22	1.95	0.47
1:A:72:SER:HB3	1:D:69:ILE:HA	1.95	0.47
1:A:298:LEU:HD11	1:A:300:ALA:HB3	1.97	0.47
1:B:417:PRO:O	1:B:420:THR:OG1	2.31	0.47
1:D:209:ASN:HA	1:D:248:TYR:CE2	2.47	0.47
1:F:138:ARG:NH1	1:F:141:ALA:O	2.47	0.47
1:H:63:ILE:HD13	1:H:152:LEU:HD12	1.95	0.47
1:F:168:THR:OG1	1:F:391:HIS:ND1	2.39	0.47
1:A:381:LEU:HG	1:A:382:LEU:HD12	1.96	0.47
1:A:164:LEU:HD23	1:A:198:MET:HE1	1.96	0.47
1:E:89:SER:OG	1:H:78:CYS:HB3	2.15	0.47
1:E:95:ILE:HD12	1:E:119:LYS:HD2	1.97	0.47
1:G:280:GLU:O	1:G:284:ILE:HG12	2.15	0.47
1:G:418:GLN:HA	1:G:421:LYS:HE3	1.97	0.47
1:D:282:LEU:HD13	1:D:309:ILE:HB	1.97	0.47
1:G:214:LYS:H	1:G:214:LYS:HG2	1.54	0.47
1:G:394:ASP:OD2	1:G:395:GLN:NE2	2.47	0.47
1:A:65:PHE:CG	1:A:110:ILE:HD11	2.50	0.47
1:D:308:SER:OG	1:D:367:ASP:OD1	2.32	0.47
1:B:65:PHE:CG	1:B:110:ILE:HD11	2.49	0.46
1:F:208:TYR:HB2	1:F:215:TYR:CZ	2.50	0.46
1:A:195:LEU:HG	1:A:235:SER:HB2	1.97	0.46
1:C:263:GLU:OE1	1:C:263:GLU:N	2.48	0.46
1:F:315:LYS:HA	1:F:328:TYR:HD2	1.79	0.46
1:G:391:HIS:HD2	1:G:405:THR:HG21	1.80	0.46
1:C:278:VAL:HG12	1:C:368:VAL:HG11	1.97	0.46
1:E:360:GLY:HA2	1:E:395:GLN:HE22	1.80	0.46
1:A:174:THR:HG23	1:A:420:THR:HG21	1.97	0.46
1:D:211:ASP:OD1	1:D:211:ASP:N	2.48	0.46

Continued on next page...

Continued from previous page...

Atom-1	Atom-2	Interatomic distance (Å)	Clash overlap (Å)
1:E:394:ASP:OD1	1:E:395:GLN:N	2.49	0.46
1:D:270:LYS:HG2	1:D:377:ILE:HD11	1.97	0.46
1:A:281:ILE:HG12	1:A:351:ILE:HD13	1.98	0.46
1:C:100:ASN:O	1:C:104:SER:HB3	2.16	0.46
1:C:146:ASN:OD1	1:C:149:ARG:NH2	2.41	0.46
1:B:144:THR:OG1	1:B:145:PHE:N	2.49	0.46
1:B:164:LEU:HD23	1:B:166:LEU:H	1.80	0.46
1:C:338:ALA:O	1:C:342:ILE:HG12	2.15	0.46
1:F:223:LEU:HA	1:F:226:PHE:HD2	1.81	0.46
1:A:144:THR:HB	1:A:147:GLU:HG3	1.98	0.46
1:C:391:HIS:HB3	1:C:405:THR:HG21	1.97	0.46
1:E:358:PHE:HZ	2:E:501:IMP:H8	1.81	0.46
1:F:208:TYR:CD2	1:F:214:LYS:HB3	2.51	0.45
1:A:174:THR:HG22	1:A:175:LEU:HD12	1.98	0.45
1:B:67:VAL:HG22	1:B:148:VAL:HG21	1.97	0.45
1:C:284:ILE:HD11	1:C:345:GLU:HG3	1.97	0.45
1:F:263:GLU:HA	1:F:266:TRP:NE1	2.31	0.45
1:G:215:TYR:OH	1:G:248:TYR:HD2	1.99	0.45
1:H:100:ASN:O	1:H:104:SER:HB3	2.17	0.45
1:A:253:ASN:ND2	1:A:257:THR:O	2.49	0.45
1:B:160:LEU:HD21	1:B:410:LEU:HD12	1.97	0.45
1:E:112:ASP:OD1	1:E:112:ASP:N	2.50	0.45
1:F:138:ARG:NH2	1:F:147:GLU:OE2	2.50	0.45
1:H:199:ASN:HB3	1:H:238:ASN:HB3	1.98	0.45
1:B:91:GLU:O	1:B:95:ILE:HG12	2.17	0.45
1:C:336:GLU:O	1:C:340:ILE:HG12	2.17	0.45
1:D:157:ILE:HG13	1:D:412:LEU:HD11	1.99	0.45
1:D:278:VAL:O	1:D:282:LEU:HD23	2.16	0.45
1:D:308:SER:OG	2:D:501:IMP:O6	2.21	0.45
1:H:144:THR:OG1	1:H:145:PHE:N	2.50	0.45
1:B:391:HIS:CD2	1:B:405:THR:HG21	2.52	0.45
1:E:138:ARG:NH2	1:E:147:GLU:OE2	2.50	0.45
1:F:138:ARG:HD2	1:F:141:ALA:HB3	1.98	0.45
1:F:144:THR:HG23	1:F:147:GLU:H	1.81	0.45
1:A:298:LEU:HD12	1:A:298:LEU:O	2.17	0.45
1:A:336:GLU:HG2	1:A:359:ASN:HD22	1.81	0.44
1:A:363:ASP:OD1	1:A:363:ASP:N	2.51	0.44
1:C:204:THR:OG1	2:C:501:IMP:O1P	2.31	0.44
1:E:91:GLU:O	1:E:95:ILE:HG12	2.17	0.44
1:F:192:SER:OG	1:F:230:ASN:OD1	2.30	0.44
1:G:287:LYS:HD3	1:G:287:LYS:HA	1.71	0.44

Continued on next page...

Continued from previous page...

Atom-1	Atom-2	Interatomic distance (Å)	Clash overlap (Å)
1:B:241:VAL:HB	1:B:250:PHE:HB2	1.99	0.44
1:D:245:GLU:HG3	1:D:371:LYS:HG3	2.00	0.44
1:F:429:HIS:O	1:F:429:HIS:ND1	2.50	0.44
1:E:304:ARG:HA	1:E:309:ILE:HA	2.00	0.44
1:A:149:ARG:HD3	1:A:413:TRP:HB3	1.99	0.44
1:B:175:LEU:HD23	1:B:187:LEU:HD21	1.99	0.44
1:B:208:TYR:HB2	1:B:215:TYR:CE1	2.53	0.44
1:D:227:SER:HA	1:D:231:ILE:HD13	2.00	0.44
1:D:365:TRP:CD1	2:D:501:IMP:H2'	2.52	0.44
1:G:401:ASN:OD1	1:G:402:ASP:N	2.51	0.44
1:C:168:THR:HG21	1:C:375:LEU:HD21	1.99	0.44
1:A:125:ALA:HA	1:A:154:LEU:HD22	2.00	0.44
1:F:338:ALA:HA	1:F:341:ARG:HD3	2.00	0.44
1:G:311:LEU:HB3	1:G:364:LEU:HB3	1.99	0.44
1:C:203:VAL:O	1:C:371:LYS:HE2	2.18	0.44
1:F:314:ASN:N	1:F:314:ASN:OD1	2.51	0.44
1:H:85:ASN:OD1	1:H:85:ASN:N	2.50	0.44
1:A:66:LEU:HB2	1:A:148:VAL:HG11	1.99	0.43
1:G:275:TYR:HA	1:G:278:VAL:HG22	2.00	0.43
1:F:243:GLY:HA3	1:F:248:TYR:HB2	2.01	0.43
1:G:315:LYS:HA	1:G:315:LYS:HD2	1.81	0.43
1:A:186:VAL:O	1:A:189:SER:OG	2.36	0.43
1:B:343:LYS:O	1:B:347:ILE:HG12	2.19	0.43
1:B:331:LYS:O	1:B:334:VAL:HG12	2.18	0.43
1:H:416:ASN:OD1	1:H:419:GLU:HG3	2.18	0.43
1:A:105:ARG:NH2	1:D:139:LEU:O	2.50	0.43
1:C:358:PHE:CE1	1:C:365:TRP:HB2	2.54	0.43
1:D:74:PHE:HA	1:D:79:ILE:HB	1.99	0.43
1:F:208:TYR:CG	1:F:214:LYS:HB3	2.53	0.43
1:C:192:SER:HB2	1:C:230:ASN:ND2	2.33	0.43
1:D:253:ASN:ND2	1:D:255:GLU:HB2	2.34	0.43
1:F:342:ILE:O	1:F:346:ILE:HG12	2.19	0.43
1:H:246:SER:OG	1:H:373:GLU:OE1	2.27	0.43
1:A:69:ILE:HG12	1:D:72:SER:HB3	2.01	0.43
1:A:171:ALA:HB3	1:A:204:THR:HB	2.00	0.43
1:E:130:ASN:O	1:E:134:ARG:N	2.40	0.43
1:E:303:GLN:NE2	1:E:312:VAL:HG21	2.33	0.43
1:E:402:ASP:O	1:E:405:THR:OG1	2.32	0.43
1:D:396:PHE:HB2	1:D:413:TRP:CE2	2.54	0.43
1:H:207:SER:HB2	1:H:244:GLY:HA2	2.01	0.43
1:B:77:ASN:O	1:B:77:ASN:ND2	2.43	0.42

Continued on next page...

Continued from previous page...

Atom-1	Atom-2	Interatomic distance (Å)	Clash overlap (Å)
1:G:240:TYR:HE2	1:G:382:LEU:HD11	1.84	0.42
1:A:336:GLU:HG2	1:A:359:ASN:ND2	2.34	0.42
1:D:71:ARG:O	1:D:75:VAL:N	2.46	0.42
1:F:286:GLU:OE1	1:F:304:ARG:NH1	2.53	0.42
1:G:177:PRO:HG2	1:G:180:HIS:CG	2.53	0.42
1:A:390:CYS:SG	1:A:391:HIS:N	2.92	0.42
1:B:291:LYS:O	1:B:295:ASP:HB2	2.19	0.42
1:D:152:LEU:HD23	1:D:152:LEU:HA	1.78	0.42
1:F:358:PHE:CZ	1:F:365:TRP:HB2	2.55	0.42
1:E:85:ASN:OD1	1:E:85:ASN:N	2.53	0.42
1:F:246:SER:HB2	1:F:270:LYS:NZ	2.35	0.42
1:G:199:ASN:HB3	1:G:238:ASN:HB3	2.00	0.42
1:A:171:ALA:HB2	1:A:202:ILE:HG23	2.02	0.42
1:E:168:THR:HG22	1:E:201:ALA:HB3	2.01	0.42
1:E:85:ASN:HD21	1:H:85:ASN:HD21	1.68	0.42
1:D:416:ASN:OD1	1:D:419:GLU:N	2.49	0.42
1:G:405:THR:HG23	1:G:411:THR:HG22	2.01	0.42
1:C:87:LEU:HB3	1:C:123:THR:HG22	2.02	0.42
1:C:296:PHE:HE1	1:D:137:LYS:HB2	1.84	0.42
1:C:172:ASN:HB2	2:C:501:IMP:H5'2	2.00	0.42
1:G:365:TRP:NE1	2:G:501:IMP:H2'	2.35	0.42
1:F:396:PHE:HB2	1:F:413:TRP:CD2	2.55	0.42
1:G:203:VAL:HG12	1:G:371:LYS:HD3	2.01	0.42
1:D:182:PHE:O	1:D:221:ASN:ND2	2.47	0.41
1:D:208:TYR:HB2	1:D:215:TYR:CE1	2.55	0.41
1:F:60:ASP:OD1	1:F:62:LEU:N	2.53	0.41
1:A:291:LYS:O	1:A:295:ASP:N	2.43	0.41
1:F:315:LYS:HA	1:F:328:TYR:CD2	2.55	0.41
1:C:139:LEU:N	1:D:337:GLU:OE1	2.53	0.41
1:D:281:ILE:HG12	1:D:351:ILE:HG21	2.02	0.41
1:B:343:LYS:HE3	1:B:343:LYS:HB3	1.72	0.41
1:E:414:VAL:HG13	1:E:419:GLU:HB2	2.02	0.41
1:G:178:ASP:N	1:G:178:ASP:OD1	2.53	0.41
1:H:64:MET:O	1:H:68:GLU:HG3	2.21	0.41
1:H:65:PHE:CG	1:H:110:ILE:HD11	2.56	0.41
1:H:164:LEU:HD23	1:H:164:LEU:HA	1.88	0.41
1:C:335:LEU:HB3	1:C:359:ASN:ND2	2.36	0.41
1:D:278:VAL:HG12	1:D:368:VAL:HG11	2.02	0.41
1:H:206:ALA:HA	2:H:501:IMP:C4	2.50	0.41
1:B:374:GLY:O	1:B:378:LEU:HG	2.21	0.41
1:G:266:TRP:HA	1:G:269:TYR:CE2	2.56	0.41

Continued on next page...

Continued from previous page...

Atom-1	Atom-2	Interatomic distance (Å)	Clash overlap (Å)
1:B:246:SER:O	1:B:270:LYS:NZ	2.53	0.41
1:F:75:VAL:HB	1:G:109:LEU:HD13	2.01	0.41
1:A:205:ALA:HB3	2:A:501:IMP:H5'1	2.03	0.41
1:A:278:VAL:HG12	1:A:368:VAL:HG11	2.03	0.41
1:B:335:LEU:CD1	1:B:364:LEU:HB2	2.51	0.41
1:B:348:LYS:HE2	1:B:348:LYS:HB3	1.94	0.41
1:D:167:LEU:HA	1:D:167:LEU:HD23	1.88	0.41
1:F:219:LEU:O	1:F:223:LEU:HD12	2.21	0.41
1:G:187:LEU:O	1:G:191:ILE:HG12	2.21	0.41
1:A:423:CYS:O	1:A:427:ILE:HG13	2.20	0.41
1:G:160:LEU:HD21	1:G:410:LEU:HD12	2.03	0.41
1:G:160:LEU:HD22	1:G:164:LEU:HB3	2.02	0.41
1:H:160:LEU:HD11	1:H:164:LEU:HG	2.03	0.41
1:C:227:SER:HB3	1:C:256:ALA:HB2	2.04	0.40
1:D:335:LEU:O	1:D:339:VAL:HG23	2.21	0.40
1:F:207:SER:O	1:F:305:LYS:NZ	2.54	0.40
1:C:240:TYR:CE2	1:C:251:LYS:HE2	2.56	0.40
1:G:138:ARG:NH2	1:G:147:GLU:OE1	2.54	0.40
1:A:144:THR:OG1	1:B:333:GLU:HG2	2.22	0.40
1:A:298:LEU:HD13	1:A:300:ALA:CB	2.51	0.40
1:D:224:LYS:O	1:D:228:LYS:HG3	2.21	0.40
1:F:363:ASP:OD1	1:F:363:ASP:N	2.55	0.40
1:A:208:TYR:HB2	1:A:215:TYR:CE1	2.55	0.40
1:D:257:THR:OG1	4:D:503:GOL:O2	2.40	0.40
1:F:240:TYR:CE2	1:F:251:LYS:HE2	2.57	0.40
1:A:286:GLU:OE1	1:A:304:ARG:NH2	2.40	0.40
1:C:172:ASN:ND2	1:C:179:GLY:H	2.18	0.40
1:E:392:ILE:HG21	1:E:420:THR:HG22	2.04	0.40
1:F:303:GLN:O	1:F:309:ILE:HG13	2.22	0.40

There are no symmetry-related clashes.

5.3 Torsion angles [i](#)

5.3.1 Protein backbone [i](#)

In the following table, the Percentiles column shows the percent Ramachandran outliers of the chain as a percentile score with respect to all X-ray entries followed by that with respect to entries of similar resolution.

The Analysed column shows the number of residues for which the backbone conformation was analysed, and the total number of residues.

Mol	Chain	Analysed	Favoured	Allowed	Outliers	Percentiles	
1	A	370/414 (89%)	346 (94%)	21 (6%)	3 (1%)	19	58
1	B	371/414 (90%)	350 (94%)	20 (5%)	1 (0%)	41	75
1	C	382/414 (92%)	362 (95%)	19 (5%)	1 (0%)	41	75
1	D	371/414 (90%)	350 (94%)	20 (5%)	1 (0%)	41	75
1	E	373/414 (90%)	352 (94%)	21 (6%)	0	100	100
1	F	374/414 (90%)	352 (94%)	21 (6%)	1 (0%)	41	75
1	G	367/414 (89%)	349 (95%)	17 (5%)	1 (0%)	41	75
1	H	371/414 (90%)	353 (95%)	18 (5%)	0	100	100
All	All	2979/3312 (90%)	2814 (94%)	157 (5%)	8 (0%)	41	75

All (8) Ramachandran outliers are listed below:

Mol	Chain	Res	Type
1	D	209	ASN
1	F	209	ASN
1	G	246	SER
1	A	171	ALA
1	C	38	SER
1	A	59	LYS
1	B	112	ASP
1	A	297	GLY

5.3.2 Protein sidechains [i](#)

In the following table, the Percentiles column shows the percent sidechain outliers of the chain as a percentile score with respect to all X-ray entries followed by that with respect to entries of similar resolution.

The Analysed column shows the number of residues for which the sidechain conformation was analysed, and the total number of residues.

Mol	Chain	Analysed	Rotameric	Outliers	Percentiles	
1	A	291/384 (76%)	290 (100%)	1 (0%)	92	97
1	B	301/384 (78%)	300 (100%)	1 (0%)	92	97
1	C	320/384 (83%)	319 (100%)	1 (0%)	92	97
1	D	326/384 (85%)	324 (99%)	2 (1%)	86	94
1	E	314/384 (82%)	311 (99%)	3 (1%)	76	88
1	F	303/384 (79%)	296 (98%)	7 (2%)	50	77

Continued on next page...

Continued from previous page...

Mol	Chain	Analysed	Rotameric	Outliers	Percentiles	
1	G	277/384 (72%)	274 (99%)	3 (1%)	73	88
1	H	292/384 (76%)	288 (99%)	4 (1%)	67	85
All	All	2424/3072 (79%)	2402 (99%)	22 (1%)	78	90

All (22) residues with a non-rotameric sidechain are listed below:

Mol	Chain	Res	Type
1	A	182	PHE
1	B	77	ASN
1	C	51	TYR
1	D	167	LEU
1	D	210	ASN
1	E	211	ASP
1	E	301	GLN
1	E	363	ASP
1	F	93	MET
1	F	100	ASN
1	F	152	LEU
1	F	164	LEU
1	F	214	LYS
1	F	295	ASP
1	F	299	CYS
1	G	142	PRO
1	G	211	ASP
1	G	268	HIS
1	H	56	LEU
1	H	100	ASN
1	H	164	LEU
1	H	390	CYS

Sometimes sidechains can be flipped to improve hydrogen bonding and reduce clashes. All (7) such sidechains are listed below:

Mol	Chain	Res	Type
1	A	230	ASN
1	A	283	ASN
1	A	359	ASN
1	B	130	ASN
1	C	230	ASN
1	C	401	ASN
1	G	230	ASN

5.3.3 RNA [i](#)

There are no RNA molecules in this entry.

5.4 Non-standard residues in protein, DNA, RNA chains [i](#)

There are no non-standard protein/DNA/RNA residues in this entry.

5.5 Carbohydrates [i](#)

There are no monosaccharides in this entry.

5.6 Ligand geometry [i](#)

Of 18 ligands modelled in this entry, 8 are monoatomic - leaving 10 for Mogul analysis.

In the following table, the Counts columns list the number of bonds (or angles) for which Mogul statistics could be retrieved, the number of bonds (or angles) that are observed in the model and the number of bonds (or angles) that are defined in the Chemical Component Dictionary. The Link column lists molecule types, if any, to which the group is linked. The Z score for a bond length (or angle) is the number of standard deviations the observed value is removed from the expected value. A bond length (or angle) with $|Z| > 2$ is considered an outlier worth inspection. RMSZ is the root-mean-square of all Z scores of the bond lengths (or angles).

Mol	Type	Chain	Res	Link	Bond lengths			Bond angles		
					Counts	RMSZ	# Z > 2	Counts	RMSZ	# Z > 2
2	IMP	B	501	3	21,25,25	1.49	2 (9%)	24,38,38	1.27	5 (20%)
2	IMP	C	501	3	21,25,25	1.49	2 (9%)	24,38,38	1.24	5 (20%)
2	IMP	E	501	3	21,25,25	1.49	2 (9%)	24,38,38	1.25	4 (16%)
2	IMP	G	501	1,3	21,25,25	1.49	2 (9%)	24,38,38	1.25	4 (16%)
2	IMP	D	501	1,3	21,25,25	1.49	2 (9%)	24,38,38	1.27	4 (16%)
2	IMP	A	501	1,3	21,25,25	1.51	2 (9%)	24,38,38	1.30	4 (16%)
2	IMP	H	501	3	21,25,25	1.51	2 (9%)	24,38,38	1.28	4 (16%)
4	GOL	E	503	-	5,5,5	0.91	0	5,5,5	1.00	0
4	GOL	D	503	-	5,5,5	0.90	0	5,5,5	1.01	0
2	IMP	F	501	1,3	21,25,25	1.49	2 (9%)	24,38,38	1.28	4 (16%)

In the following table, the Chirals column lists the number of chiral outliers, the number of chiral centers analysed, the number of these observed in the model and the number defined in the Chemical Component Dictionary. Similar counts are reported in the Torsion and Rings columns. '-' means no outliers of that kind were identified.

Mol	Type	Chain	Res	Link	Chirals	Torsions	Rings
2	IMP	B	501	3	-	5/6/26/26	0/3/3/3
2	IMP	C	501	3	-	5/6/26/26	0/3/3/3
2	IMP	E	501	3	-	2/6/26/26	0/3/3/3
2	IMP	G	501	1,3	-	4/6/26/26	0/3/3/3
2	IMP	D	501	1,3	-	4/6/26/26	0/3/3/3
2	IMP	A	501	1,3	-	4/6/26/26	0/3/3/3
2	IMP	H	501	3	-	3/6/26/26	0/3/3/3
4	GOL	E	503	-	-	2/4/4/4	-
4	GOL	D	503	-	-	0/4/4/4	-
2	IMP	F	501	1,3	-	4/6/26/26	0/3/3/3

All (16) bond length outliers are listed below:

Mol	Chain	Res	Type	Atoms	Z	Observed(Å)	Ideal(Å)
2	H	501	IMP	C2-N3	4.83	1.38	1.29
2	F	501	IMP	C2-N3	4.83	1.38	1.29
2	B	501	IMP	C2-N3	4.82	1.38	1.29
2	E	501	IMP	C2-N3	4.80	1.38	1.29
2	A	501	IMP	C2-N3	4.80	1.38	1.29
2	G	501	IMP	C2-N3	4.79	1.38	1.29
2	D	501	IMP	C2-N3	4.79	1.38	1.29
2	C	501	IMP	C2-N3	4.77	1.38	1.29
2	H	501	IMP	C5-C6	-4.04	1.39	1.47
2	D	501	IMP	C5-C6	-4.01	1.39	1.47
2	C	501	IMP	C5-C6	-4.00	1.39	1.47
2	A	501	IMP	C5-C6	-3.99	1.39	1.47
2	B	501	IMP	C5-C6	-3.98	1.39	1.47
2	E	501	IMP	C5-C6	-3.97	1.39	1.47
2	F	501	IMP	C5-C6	-3.96	1.39	1.47
2	G	501	IMP	C5-C6	-3.92	1.39	1.47

All (34) bond angle outliers are listed below:

Mol	Chain	Res	Type	Atoms	Z	Observed(°)	Ideal(°)
2	H	501	IMP	C5-C6-N1	3.25	119.69	113.95
2	D	501	IMP	C5-C6-N1	3.21	119.62	113.95
2	B	501	IMP	C5-C6-N1	3.17	119.55	113.95
2	C	501	IMP	C5-C6-N1	3.13	119.48	113.95
2	E	501	IMP	C5-C6-N1	3.11	119.45	113.95
2	G	501	IMP	C5-C6-N1	3.05	119.33	113.95
2	A	501	IMP	C5-C6-N1	3.00	119.25	113.95

Continued on next page...

Continued from previous page...

Mol	Chain	Res	Type	Atoms	Z	Observed(°)	Ideal(°)
2	F	501	IMP	C5-C6-N1	3.00	119.25	113.95
2	H	501	IMP	C8-N7-C5	2.99	108.69	102.99
2	F	501	IMP	C8-N7-C5	2.97	108.64	102.99
2	E	501	IMP	C8-N7-C5	2.96	108.63	102.99
2	B	501	IMP	C8-N7-C5	2.94	108.60	102.99
2	A	501	IMP	C8-N7-C5	2.94	108.60	102.99
2	G	501	IMP	C8-N7-C5	2.94	108.60	102.99
2	D	501	IMP	C8-N7-C5	2.89	108.49	102.99
2	C	501	IMP	C8-N7-C5	2.88	108.48	102.99
2	F	501	IMP	O6-C6-C5	-2.72	119.07	124.37
2	G	501	IMP	O6-C6-C5	-2.49	119.52	124.37
2	D	501	IMP	O6-C6-C5	-2.47	119.55	124.37
2	A	501	IMP	O6-C6-C5	-2.45	119.58	124.37
2	E	501	IMP	O6-C6-C5	-2.32	119.83	124.37
2	B	501	IMP	O6-C6-C5	-2.29	119.89	124.37
2	C	501	IMP	O6-C6-C5	-2.27	119.94	124.37
2	H	501	IMP	O6-C6-C5	-2.22	120.03	124.37
2	G	501	IMP	N1-C2-N3	-2.18	120.17	125.87
2	B	501	IMP	N1-C2-N3	-2.18	120.19	125.87
2	H	501	IMP	N1-C2-N3	-2.17	120.20	125.87
2	C	501	IMP	N1-C2-N3	-2.16	120.24	125.87
2	E	501	IMP	N1-C2-N3	-2.14	120.28	125.87
2	F	501	IMP	N1-C2-N3	-2.12	120.33	125.87
2	D	501	IMP	N1-C2-N3	-2.12	120.34	125.87
2	A	501	IMP	N1-C2-N3	-2.10	120.38	125.87
2	B	501	IMP	O2P-P-O1P	2.04	118.67	110.68
2	C	501	IMP	O2P-P-O1P	2.02	118.58	110.68

There are no chirality outliers.

All (33) torsion outliers are listed below:

Mol	Chain	Res	Type	Atoms
2	A	501	IMP	C5'-O5'-P-O1P
2	A	501	IMP	C5'-O5'-P-O2P
2	A	501	IMP	C5'-O5'-P-O3P
2	A	501	IMP	O4'-C4'-C5'-O5'
2	B	501	IMP	C5'-O5'-P-O1P
2	B	501	IMP	C5'-O5'-P-O2P
2	B	501	IMP	C5'-O5'-P-O3P
2	B	501	IMP	O4'-C4'-C5'-O5'
2	C	501	IMP	C5'-O5'-P-O1P
2	C	501	IMP	C5'-O5'-P-O2P

Continued on next page...

Continued from previous page...

Mol	Chain	Res	Type	Atoms
2	C	501	IMP	C5'-O5'-P-O3P
2	D	501	IMP	C5'-O5'-P-O1P
2	D	501	IMP	C5'-O5'-P-O2P
2	D	501	IMP	C5'-O5'-P-O3P
2	E	501	IMP	C3'-C4'-C5'-O5'
2	F	501	IMP	C5'-O5'-P-O2P
2	F	501	IMP	C5'-O5'-P-O3P
2	G	501	IMP	C5'-O5'-P-O1P
2	G	501	IMP	C5'-O5'-P-O2P
2	G	501	IMP	C5'-O5'-P-O3P
2	G	501	IMP	O4'-C4'-C5'-O5'
2	H	501	IMP	C5'-O5'-P-O3P
4	E	503	GOL	O1-C1-C2-C3
2	C	501	IMP	O4'-C4'-C5'-O5'
2	E	501	IMP	O4'-C4'-C5'-O5'
2	C	501	IMP	C3'-C4'-C5'-O5'
4	E	503	GOL	O1-C1-C2-O2
2	F	501	IMP	C5'-O5'-P-O1P
2	H	501	IMP	C5'-O5'-P-O1P
2	H	501	IMP	C5'-O5'-P-O2P
2	F	501	IMP	C3'-C4'-C5'-O5'
2	D	501	IMP	O4'-C4'-C5'-O5'
2	B	501	IMP	C3'-C4'-C5'-O5'

There are no ring outliers.

8 monomers are involved in 17 short contacts:

Mol	Chain	Res	Type	Clashes	Symm-Clashes
2	C	501	IMP	5	0
2	E	501	IMP	2	0
2	G	501	IMP	1	0
2	D	501	IMP	3	0
2	A	501	IMP	2	0
2	H	501	IMP	2	0
4	D	503	GOL	1	0
2	F	501	IMP	1	0

The following is a two-dimensional graphical depiction of Mogul quality analysis of bond lengths, bond angles, torsion angles, and ring geometry for all instances of the Ligand of Interest. In addition, ligands with molecular weight > 250 and outliers as shown on the validation Tables will also be included. For torsion angles, if less than 5% of the Mogul distribution of torsion angles is within 10 degrees of the torsion angle in question, then that torsion angle is considered an outlier.

Any bond that is central to one or more torsion angles identified as an outlier by Mogul will be highlighted in the graph. For rings, the root-mean-square deviation (RMSD) between the ring in question and similar rings identified by Mogul is calculated over all ring torsion angles. If the average RMSD is greater than 60 degrees and the minimal RMSD between the ring in question and any Mogul-identified rings is also greater than 60 degrees, then that ring is considered an outlier. The outliers are highlighted in purple. The color gray indicates Mogul did not find sufficient equivalents in the CSD to analyse the geometry.

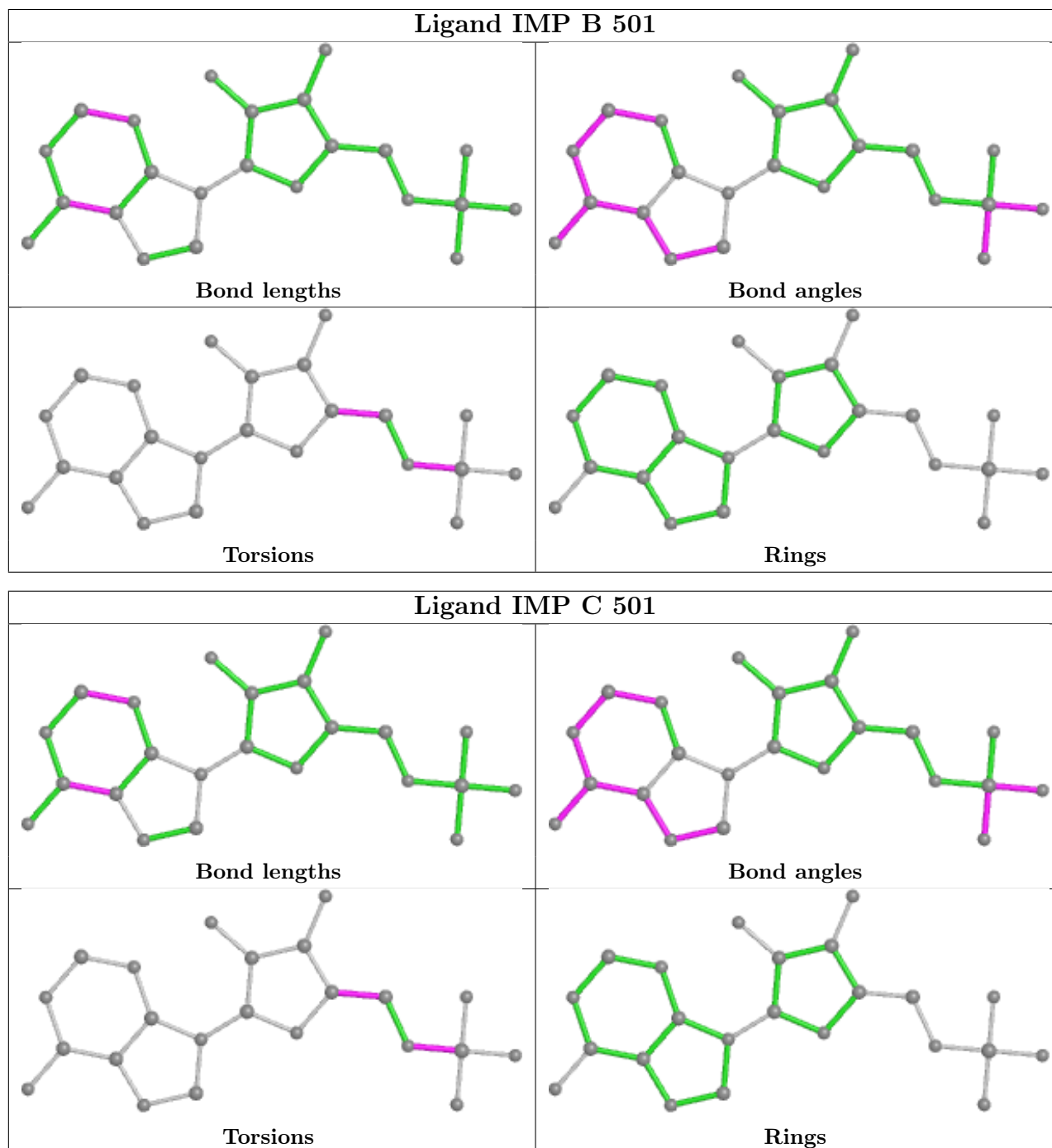

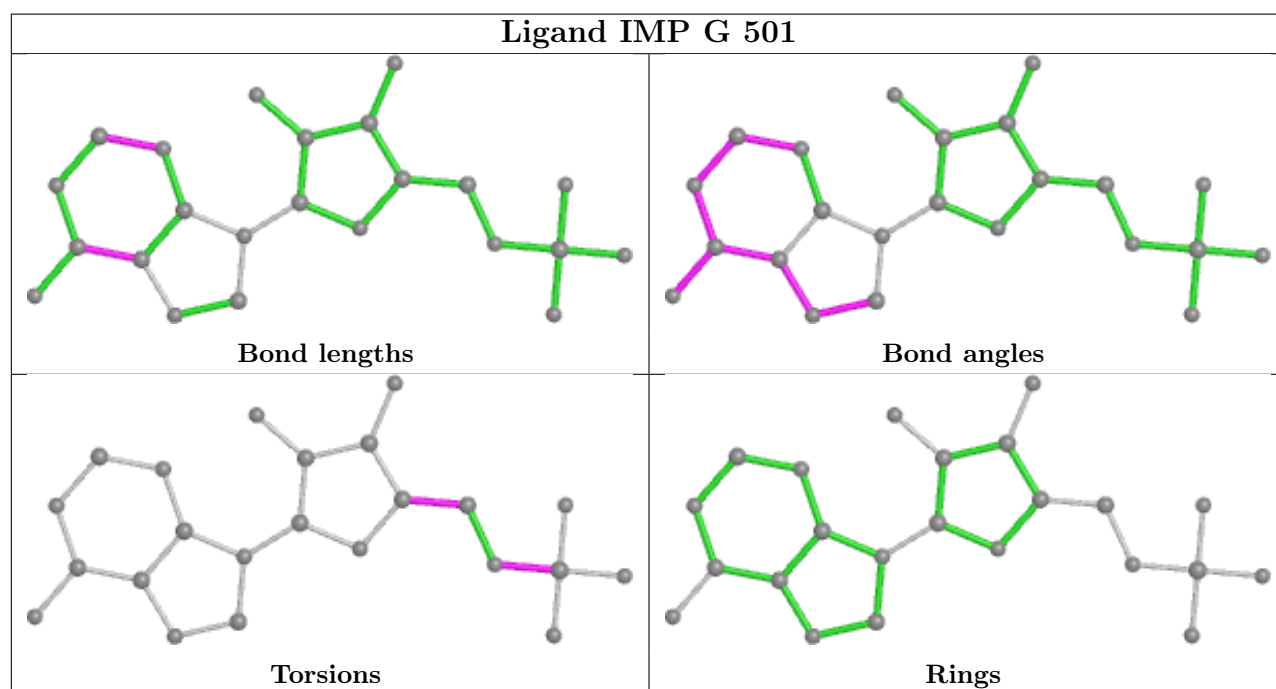
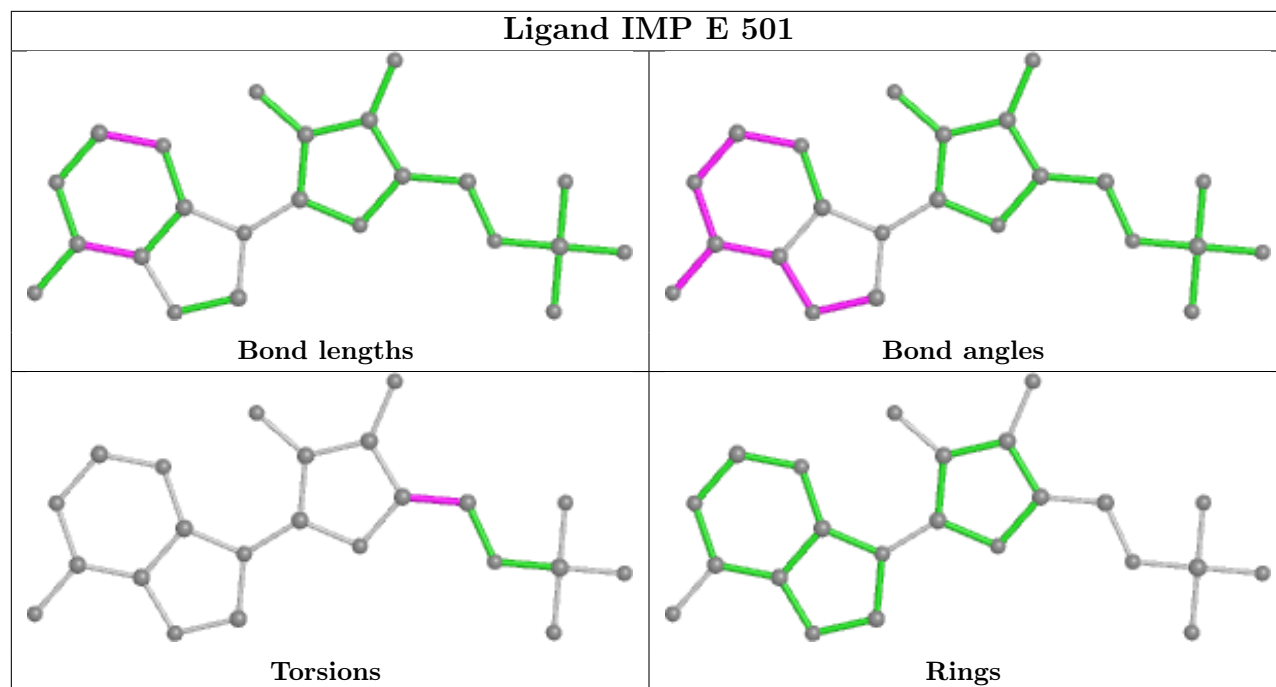

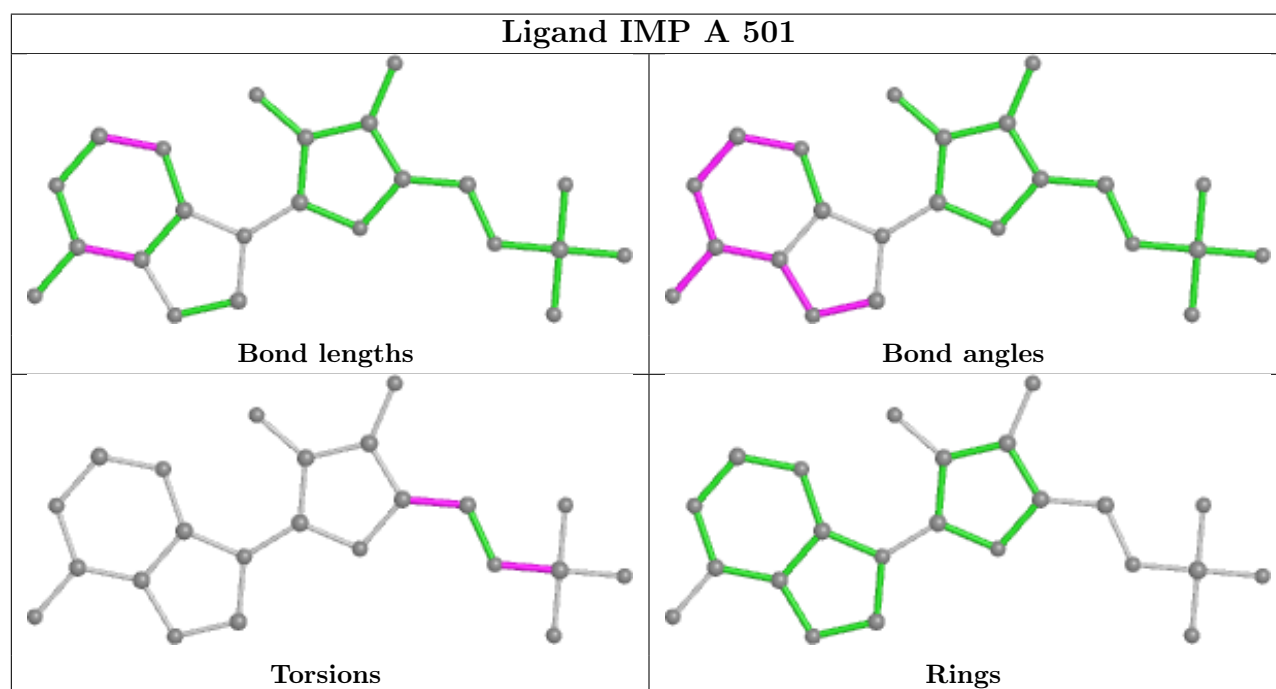
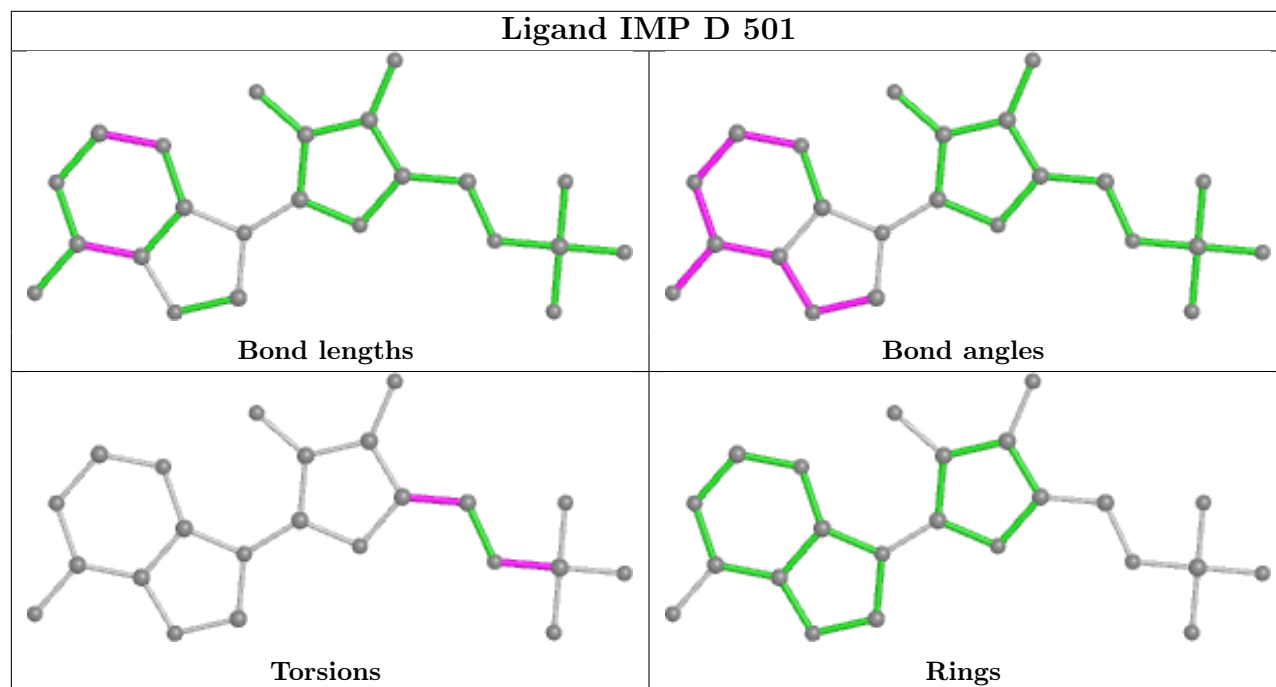

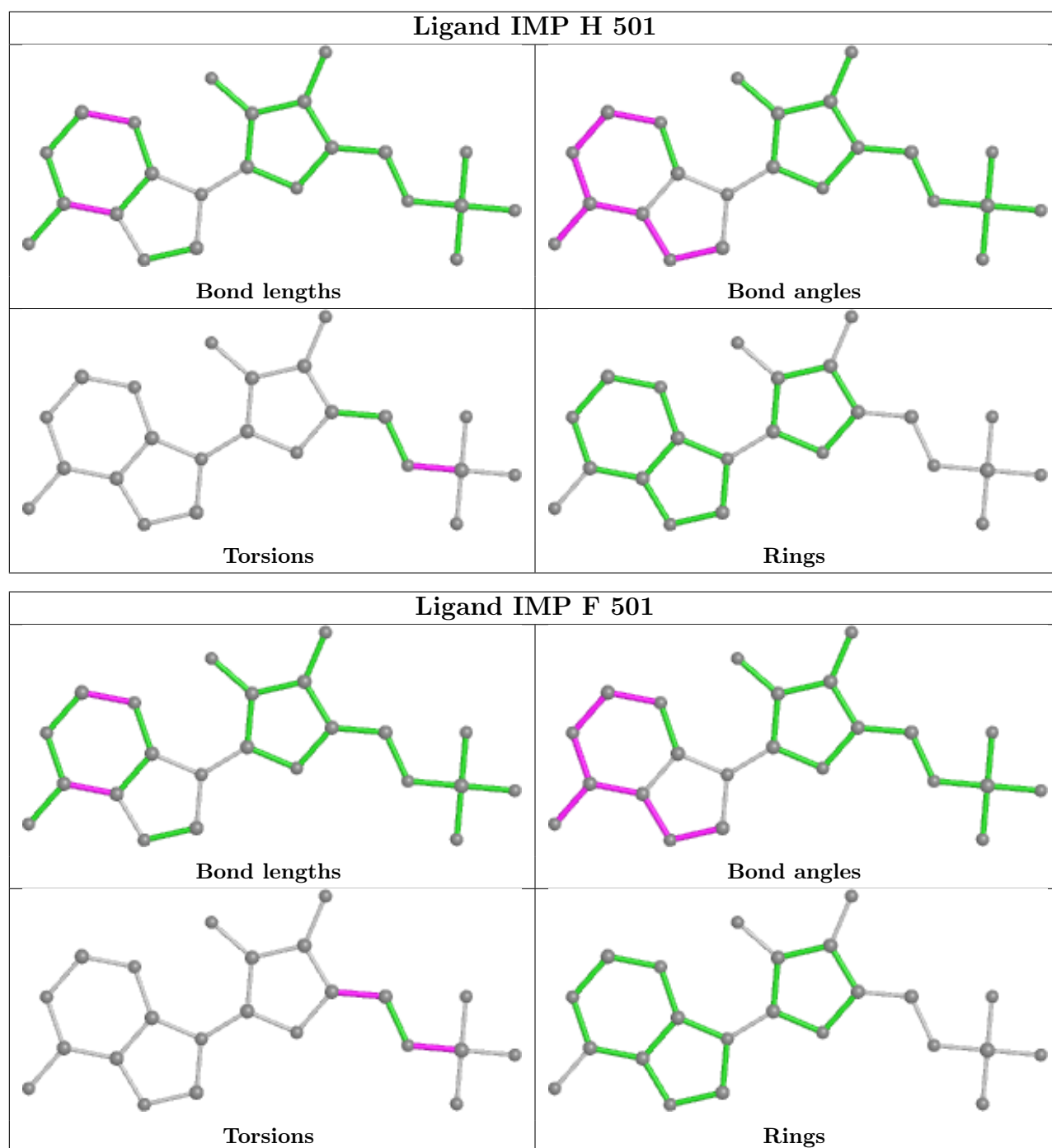

5.7 Other polymers [i](#)

There are no such residues in this entry.

5.8 Polymer linkage issues [i](#)

There are no chain breaks in this entry.

6 Fit of model and data

6.1 Protein, DNA and RNA chains

In the following table, the column labelled ‘#RSRZ > 2’ contains the number (and percentage) of RSRZ outliers, followed by percent RSRZ outliers for the chain as percentile scores relative to all X-ray entries and entries of similar resolution. The OWAB column contains the minimum, median, 95th percentile and maximum values of the occupancy-weighted average B-factor per residue. The column labelled ‘Q < 0.9’ lists the number of (and percentage) of residues with an average occupancy less than 0.9.

Mol	Chain	Analysed	<RSRZ>	#RSRZ>2	OWAB(Å ²)	Q<0.9
1	A	374/414 (90%)	-0.19	5 (1%) 77 71	93, 148, 195, 213	0
1	B	375/414 (90%)	-0.11	14 (3%) 41 37	95, 154, 189, 211	0
1	C	386/414 (93%)	-0.20	5 (1%) 77 71	90, 129, 173, 208	0
1	D	375/414 (90%)	-0.29	1 (0%) 94 91	87, 127, 166, 197	0
1	E	377/414 (91%)	-0.29	4 (1%) 80 75	93, 124, 163, 190	0
1	F	378/414 (91%)	-0.11	12 (3%) 47 42	91, 135, 182, 201	0
1	G	371/414 (89%)	-0.16	13 (3%) 44 39	95, 155, 198, 234	0
1	H	375/414 (90%)	-0.22	7 (1%) 66 61	96, 141, 186, 218	0
All	All	3011/3312 (90%)	-0.20	61 (2%) 65 60	87, 138, 186, 234	0

All (61) RSRZ outliers are listed below:

Mol	Chain	Res	Type	RSRZ
1	G	200	ILE	5.9
1	B	357	ALA	5.5
1	G	201	ALA	5.0
1	B	200	ILE	4.8
1	D	204	THR	4.1
1	H	201	ALA	4.1
1	F	200	ILE	4.0
1	B	240	TYR	4.0
1	H	202	ILE	3.8
1	H	240	TYR	3.6
1	F	256	ALA	3.6
1	B	201	ALA	3.5
1	H	241	VAL	3.5
1	F	223	LEU	3.5
1	F	201	ALA	3.3
1	B	239	PHE	3.3

Continued on next page...

Continued from previous page...

Mol	Chain	Res	Type	RSRZ
1	H	200	ILE	3.3
1	B	227	SER	3.0
1	G	202	ILE	3.0
1	G	203	VAL	3.0
1	G	239	PHE	3.0
1	B	358	PHE	2.9
1	B	366	VAL	2.8
1	F	349	ASN	2.8
1	B	223	LEU	2.8
1	F	368	VAL	2.8
1	F	240	TYR	2.8
1	C	368	VAL	2.7
1	B	202	ILE	2.7
1	B	356	CYS	2.7
1	C	43	ASN	2.6
1	G	169	PHE	2.6
1	B	169	PHE	2.6
1	G	240	TYR	2.6
1	G	51	TYR	2.6
1	H	249	LEU	2.5
1	G	158	LEU	2.5
1	F	202	ILE	2.4
1	G	357	ALA	2.3
1	G	296	PHE	2.3
1	G	242	MET	2.3
1	F	311	LEU	2.2
1	H	239	PHE	2.2
1	F	312	VAL	2.2
1	E	310	GLY	2.2
1	C	357	ALA	2.2
1	A	424	LEU	2.2
1	B	241	VAL	2.2
1	E	226	PHE	2.2
1	G	273	VAL	2.2
1	C	242	MET	2.1
1	A	166	LEU	2.1
1	A	73	LEU	2.1
1	E	240	TYR	2.1
1	A	99	TYR	2.1
1	B	242	MET	2.1
1	F	169	PHE	2.1
1	C	40	MET	2.1

Continued on next page...

Continued from previous page...

Mol	Chain	Res	Type	RSRZ
1	F	424	LEU	2.1
1	A	303	GLN	2.0
1	E	273	VAL	2.0

6.2 Non-standard residues in protein, DNA, RNA chains [i](#)

There are no non-standard protein/DNA/RNA residues in this entry.

6.3 Carbohydrates [i](#)

There are no monosaccharides in this entry.

6.4 Ligands [i](#)

In the following table, the Atoms column lists the number of modelled atoms in the group and the number defined in the chemical component dictionary. The B-factors column lists the minimum, median, 95th percentile and maximum values of B factors of atoms in the group. The column labelled 'Q< 0.9' lists the number of atoms with occupancy less than 0.9.

Mol	Type	Chain	Res	Atoms	RSCC	RSR	B-factors(Å ²)	Q<0.9
4	GOL	E	503	6/6	0.56	0.19	129,147,162,167	0
4	GOL	D	503	6/6	0.71	0.17	127,150,153,154	0
3	MG	G	502	1/1	0.75	0.25	128,128,128,128	0
2	IMP	E	501	23/23	0.76	0.25	122,144,158,163	0
2	IMP	D	501	23/23	0.76	0.23	108,124,143,154	0
2	IMP	G	501	23/23	0.81	0.18	145,178,195,208	0
2	IMP	A	501	23/23	0.81	0.20	148,178,189,203	0
2	IMP	H	501	23/23	0.82	0.17	139,155,169,179	0
2	IMP	B	501	23/23	0.82	0.27	145,175,199,205	0
2	IMP	F	501	23/23	0.86	0.20	125,153,180,190	0
2	IMP	C	501	23/23	0.86	0.16	124,137,152,155	0
3	MG	F	502	1/1	0.88	0.20	117,117,117,117	0
3	MG	A	502	1/1	0.89	0.31	122,122,122,122	0
3	MG	C	502	1/1	0.92	0.27	85,85,85,85	0
3	MG	B	502	1/1	0.94	0.28	128,128,128,128	0
3	MG	H	502	1/1	0.95	0.31	112,112,112,112	0
3	MG	E	502	1/1	0.96	0.27	105,105,105,105	0
3	MG	D	502	1/1	0.97	0.32	104,104,104,104	0

The following is a graphical depiction of the model fit to experimental electron density of all

instances of the Ligand of Interest. In addition, ligands with molecular weight > 250 and outliers as shown on the geometry validation Tables will also be included. Each fit is shown from different orientation to approximate a three-dimensional view.

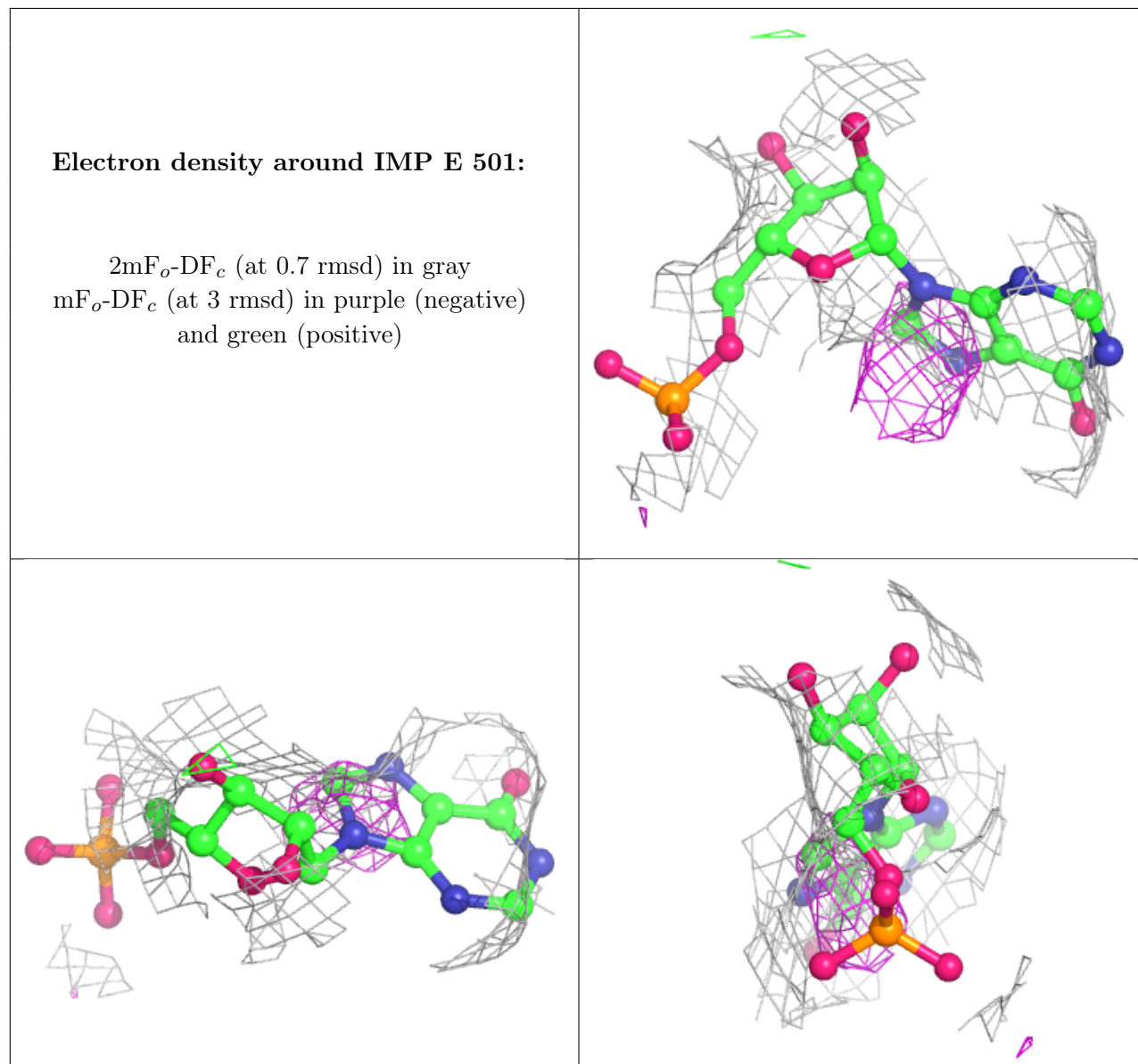

Electron density around IMP D 501:

$2mF_o-DF_c$ (at 0.7 rmsd) in gray
 mF_o-DF_c (at 3 rmsd) in purple (negative)
and green (positive)

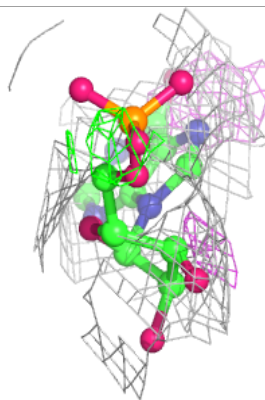
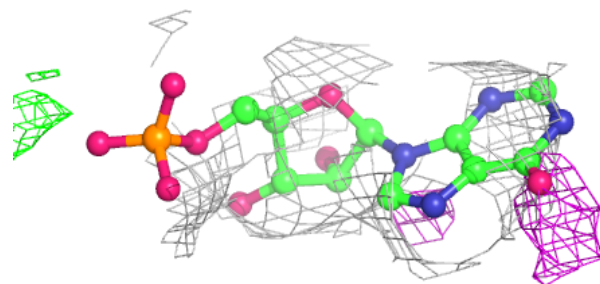
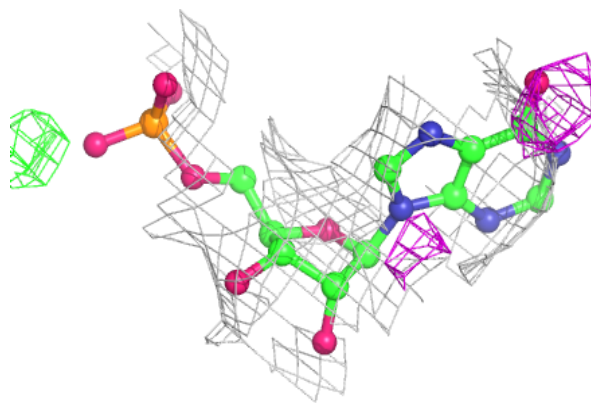
**Electron density around IMP G 501:**

$2mF_o-DF_c$ (at 0.7 rmsd) in gray
 mF_o-DF_c (at 3 rmsd) in purple (negative)
and green (positive)

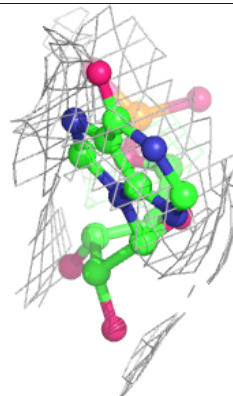
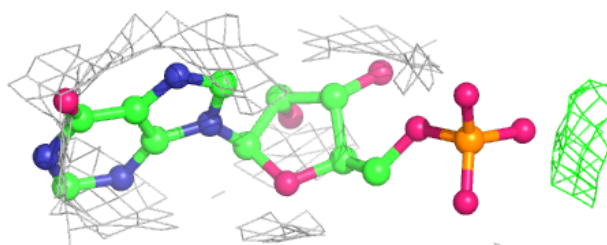
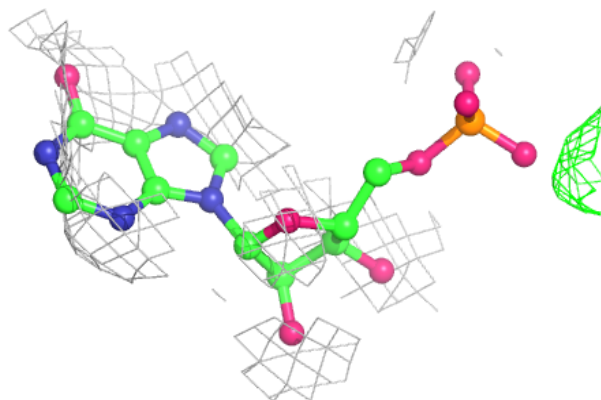

Electron density around IMP A 501:

$2mF_o-DF_c$ (at 0.7 rmsd) in gray
 mF_o-DF_c (at 3 rmsd) in purple (negative)
and green (positive)

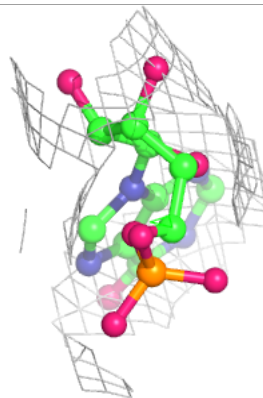
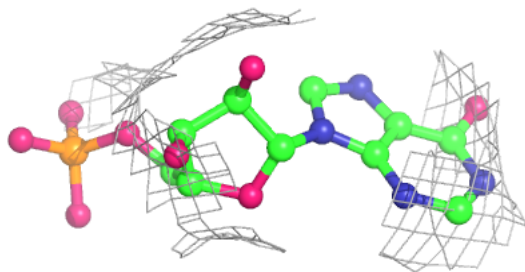
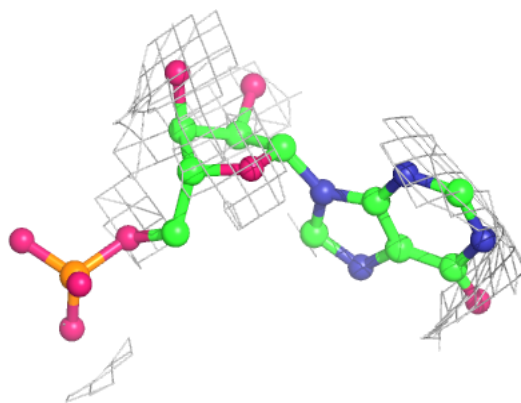
**Electron density around IMP H 501:**

$2mF_o-DF_c$ (at 0.7 rmsd) in gray
 mF_o-DF_c (at 3 rmsd) in purple (negative)
and green (positive)

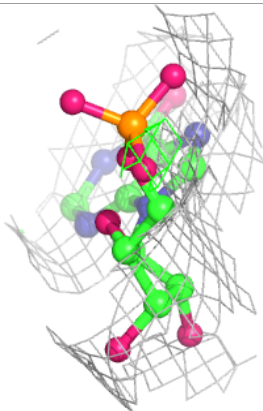
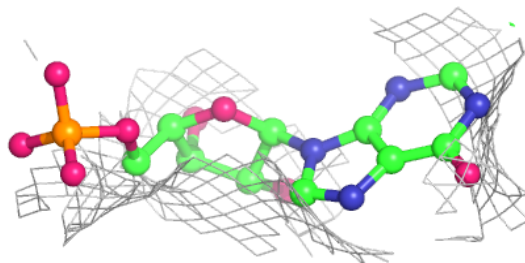
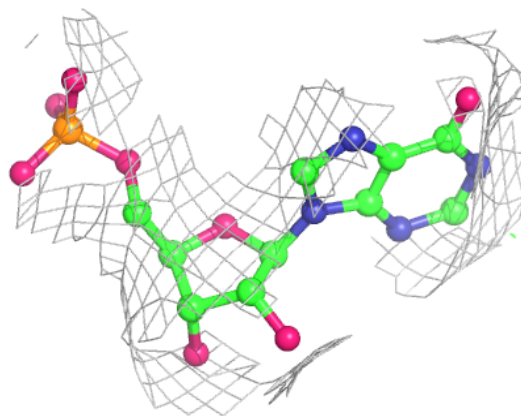

Electron density around IMP B 501:

$2mF_o-DF_c$ (at 0.7 rmsd) in gray
 mF_o-DF_c (at 3 rmsd) in purple (negative)
and green (positive)

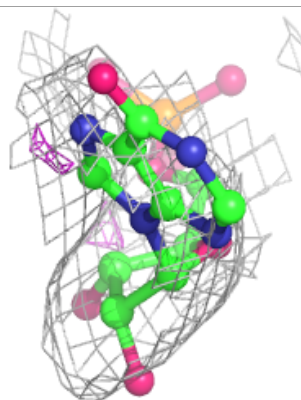
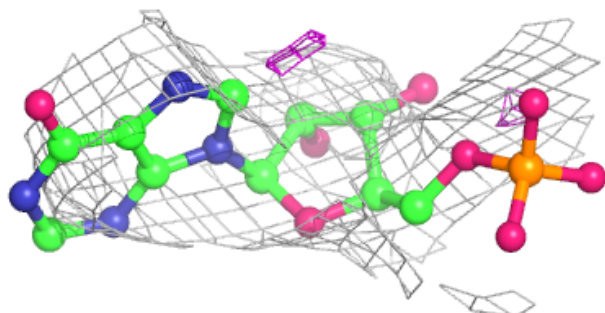
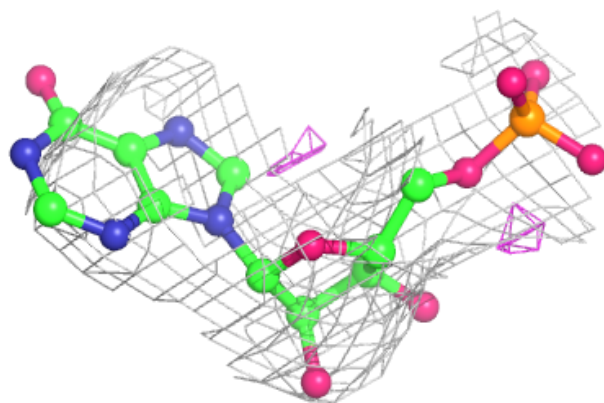
**Electron density around IMP F 501:**

$2mF_o-DF_c$ (at 0.7 rmsd) in gray
 mF_o-DF_c (at 3 rmsd) in purple (negative)
and green (positive)

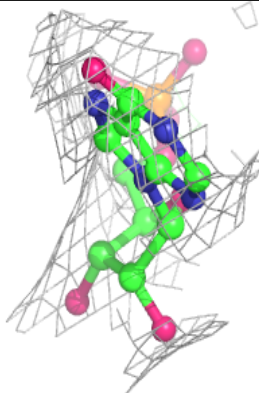
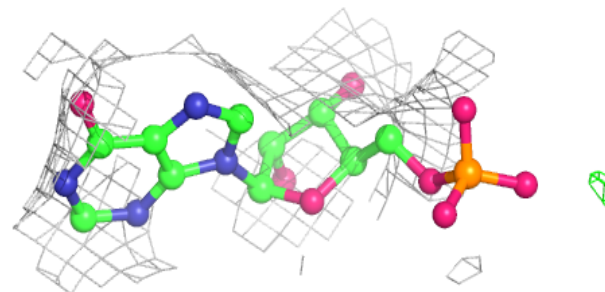
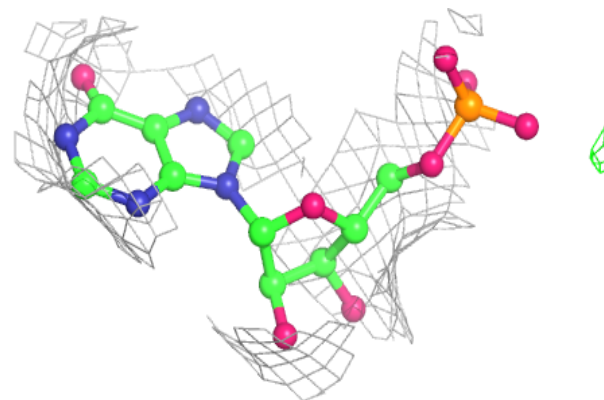

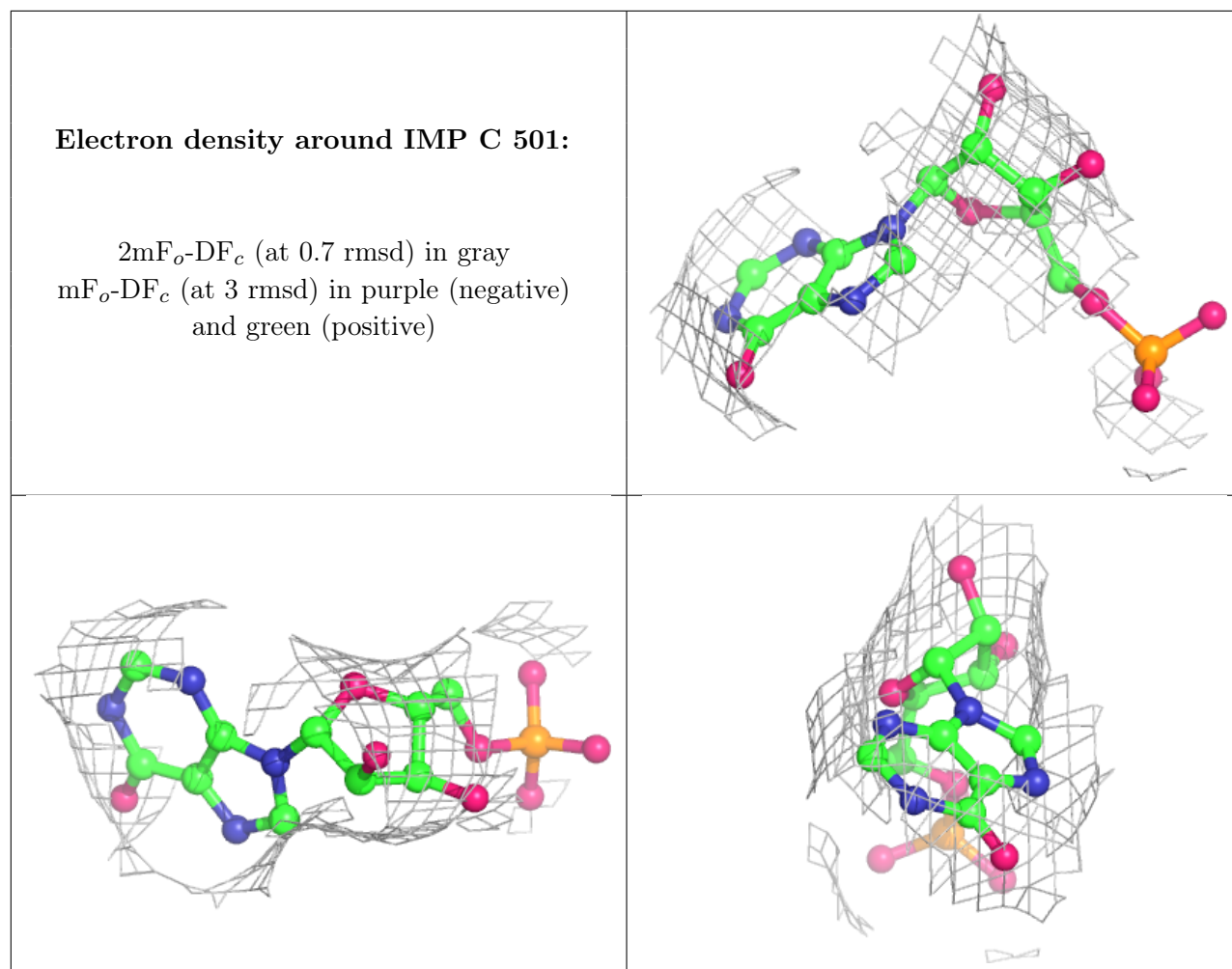

6.5 Other polymers [i](#)

There are no such residues in this entry.