



Full wwPDB X-ray Structure Validation Report ⓘ

May 14, 2020 – 03:03 pm BST

PDB ID : 5OSB
Title : GLIC-GABAAR alpha1 chimera crystallized in complex with THDOC at pH4.5
Authors : Lavery, D.C.; Gold, M.G.; Smart, T.G.
Deposited on : 2017-08-17
Resolution : 3.80 Å(reported)

This is a Full wwPDB X-ray Structure Validation Report for a publicly released PDB entry.

We welcome your comments at validation@mail.wwpdb.org

A user guide is available at

<https://www.wwpdb.org/validation/2017/XrayValidationReportHelp>

with specific help available everywhere you see the ⓘ symbol.

The following versions of software and data (see [references ⓘ](#)) were used in the production of this report:

MolProbity : 4.02b-467
Mogul : 1.8.5 (274361), CSD as541be (2020)
Xtriage (Phenix) : 1.13
EDS : 2.11
buster-report : 1.1.7 (2018)
Percentile statistics : 20191225.v01 (using entries in the PDB archive December 25th 2019)
Refmac : 5.8.0158
CCP4 : 7.0.044 (Gargrove)
Ideal geometry (proteins) : Engh & Huber (2001)
Ideal geometry (DNA, RNA) : Parkinson et al. (1996)
Validation Pipeline (wwPDB-VP) : 2.11

1 Overall quality at a glance

The following experimental techniques were used to determine the structure:

X-RAY DIFFRACTION

The reported resolution of this entry is 3.80 Å.

Percentile scores (ranging between 0-100) for global validation metrics of the entry are shown in the following graphic. The table shows the number of entries on which the scores are based.

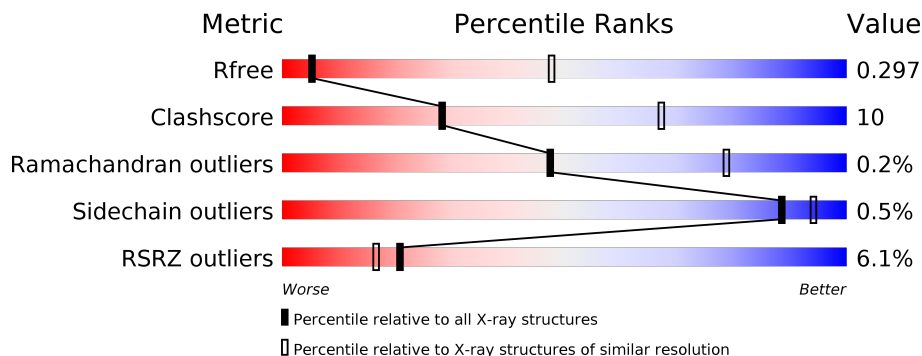

Metric	Whole archive (#Entries)	Similar resolution (#Entries, resolution range(Å))
R_{free}	130704	1212 (4.00-3.60)
Clashscore	141614	1288 (4.00-3.60)
Ramachandran outliers	138981	1243 (4.00-3.60)
Sidechain outliers	138945	1237 (4.00-3.60)
RSRZ outliers	127900	1121 (4.00-3.60)

The table below summarises the geometric issues observed across the polymeric chains and their fit to the electron density. The red, orange, yellow and green segments on the lower bar indicate the fraction of residues that contain outliers for ≥ 3 , 2, 1 and 0 types of geometric quality criteria respectively. A grey segment represents the fraction of residues that are not modelled. The numeric value for each fraction is indicated below the corresponding segment, with a dot representing fractions $\leq 5\%$. The upper red bar (where present) indicates the fraction of residues that have poor fit to the electron density. The numeric value is given above the bar.

Mol	Chain	Length	Quality of chain
1	A	336	 2% 75% 18% 7%
1	B	336	 5% 70% 23% 7%
1	C	336	 11% 72% 20% 8%
1	D	336	 5% 73% 20% 7%
1	E	336	 4% 73% 20% 7%

The following table lists non-polymeric compounds, carbohydrate monomers and non-standard residues in protein, DNA, RNA chains that are outliers for geometric or electron-density-fit criteria:

Mol	Type	Chain	Res	Chirality	Geometry	Clashes	Electron density
3	ACT	B	502	-	-	X	-

2 Entry composition i

There are 4 unique types of molecules in this entry. The entry contains 12746 atoms, of which 185 are hydrogens and 0 are deuteriums.

In the tables below, the ZeroOcc column contains the number of atoms modelled with zero occupancy, the AltConf column contains the number of residues with at least one atom in alternate conformation and the Trace column contains the number of residues modelled with at most 2 atoms.

- Molecule 1 is a protein called Proton-gated ion channel, Gamma-aminobutyric acid receptor subunit alpha-1, Gamma-aminobutyric acid receptor subunit alpha-1.

Mol	Chain	Residues	Atoms					ZeroOcc	AltConf	Trace
			Total	C	N	O	S			
1	A	313	2485	1624	399	456	6	0	0	0
1	B	313	2491	1627	402	456	6	0	0	0
1	C	310	2473	1617	397	453	6	0	0	0
1	D	313	2485	1624	399	456	6	0	0	0
1	E	313	2485	1624	399	456	6	0	0	0

There are 80 discrepancies between the modelled and reference sequences:

Chain	Residue	Modelled	Actual	Comment	Reference
A	258	VAL	GLY	conflict	UNP P62812
A	312	SER	-	linker	UNP P62812
A	313	GLN	-	linker	UNP P62812
A	314	PRO	-	linker	UNP P62812
A	315	ALA	-	linker	UNP P62812
A	316	ARG	-	linker	UNP P62812
A	317	ALA	-	linker	UNP P62812
A	318	ALA	-	linker	UNP P62812
A	429	HIS	-	expression tag	UNP P62812
A	430	HIS	-	expression tag	UNP P62812
A	431	HIS	-	expression tag	UNP P62812
A	432	HIS	-	expression tag	UNP P62812
A	433	HIS	-	expression tag	UNP P62812
A	434	HIS	-	expression tag	UNP P62812
A	435	HIS	-	expression tag	UNP P62812
A	436	HIS	-	expression tag	UNP P62812
B	258	VAL	GLY	conflict	UNP P62812
B	312	SER	-	linker	UNP P62812

Continued on next page...

Continued from previous page...

Chain	Residue	Modelled	Actual	Comment	Reference
B	313	GLN	-	linker	UNP P62812
B	314	PRO	-	linker	UNP P62812
B	315	ALA	-	linker	UNP P62812
B	316	ARG	-	linker	UNP P62812
B	317	ALA	-	linker	UNP P62812
B	318	ALA	-	linker	UNP P62812
B	429	HIS	-	expression tag	UNP P62812
B	430	HIS	-	expression tag	UNP P62812
B	431	HIS	-	expression tag	UNP P62812
B	432	HIS	-	expression tag	UNP P62812
B	433	HIS	-	expression tag	UNP P62812
B	434	HIS	-	expression tag	UNP P62812
B	435	HIS	-	expression tag	UNP P62812
B	436	HIS	-	expression tag	UNP P62812
C	258	VAL	GLY	conflict	UNP P62812
C	312	SER	-	linker	UNP P62812
C	313	GLN	-	linker	UNP P62812
C	314	PRO	-	linker	UNP P62812
C	315	ALA	-	linker	UNP P62812
C	316	ARG	-	linker	UNP P62812
C	317	ALA	-	linker	UNP P62812
C	318	ALA	-	linker	UNP P62812
C	429	HIS	-	expression tag	UNP P62812
C	430	HIS	-	expression tag	UNP P62812
C	431	HIS	-	expression tag	UNP P62812
C	432	HIS	-	expression tag	UNP P62812
C	433	HIS	-	expression tag	UNP P62812
C	434	HIS	-	expression tag	UNP P62812
C	435	HIS	-	expression tag	UNP P62812
C	436	HIS	-	expression tag	UNP P62812
D	258	VAL	GLY	conflict	UNP P62812
D	312	SER	-	linker	UNP P62812
D	313	GLN	-	linker	UNP P62812
D	314	PRO	-	linker	UNP P62812
D	315	ALA	-	linker	UNP P62812
D	316	ARG	-	linker	UNP P62812
D	317	ALA	-	linker	UNP P62812
D	318	ALA	-	linker	UNP P62812
D	429	HIS	-	expression tag	UNP P62812
D	430	HIS	-	expression tag	UNP P62812
D	431	HIS	-	expression tag	UNP P62812
D	432	HIS	-	expression tag	UNP P62812

Continued on next page...

Continued from previous page...

Chain	Residue	Modelled	Actual	Comment	Reference
D	433	HIS	-	expression tag	UNP P62812
D	434	HIS	-	expression tag	UNP P62812
D	435	HIS	-	expression tag	UNP P62812
D	436	HIS	-	expression tag	UNP P62812
E	258	VAL	GLY	conflict	UNP P62812
E	312	SER	-	linker	UNP P62812
E	313	GLN	-	linker	UNP P62812
E	314	PRO	-	linker	UNP P62812
E	315	ALA	-	linker	UNP P62812
E	316	ARG	-	linker	UNP P62812
E	317	ALA	-	linker	UNP P62812
E	318	ALA	-	linker	UNP P62812
E	429	HIS	-	expression tag	UNP P62812
E	430	HIS	-	expression tag	UNP P62812
E	431	HIS	-	expression tag	UNP P62812
E	432	HIS	-	expression tag	UNP P62812
E	433	HIS	-	expression tag	UNP P62812
E	434	HIS	-	expression tag	UNP P62812
E	435	HIS	-	expression tag	UNP P62812
E	436	HIS	-	expression tag	UNP P62812

- Molecule 2 is Tetrahydrodeoxycorticosterone (three-letter code: A8Z) (formula: $C_{21}H_{34}O_3$).

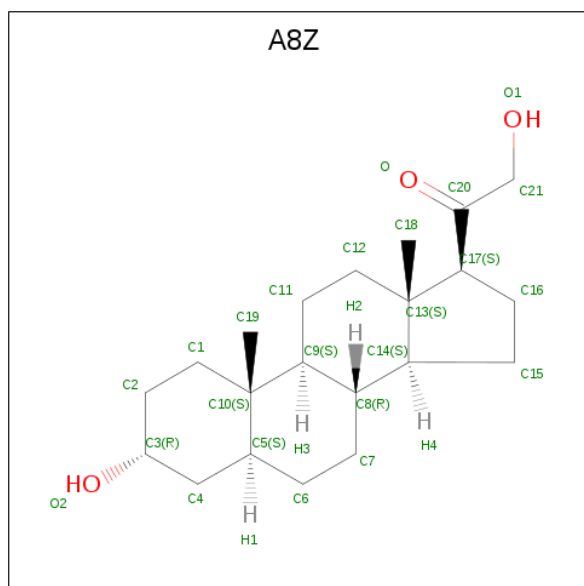

Mol	Chain	Residues	Atoms			ZeroOcc	AltConf
			Total	C	H		
2	A	1	58	21	34	3	0

Continued on next page...

Continued from previous page...

Mol	Chain	Residues	Atoms				ZeroOcc	AltConf
2	A	1	Total	C	H	O	0	0
			58	21	34	3		
2	B	1	Total	C	H	O	0	0
			58	21	34	3		
2	C	1	Total	C	H	O	0	0
			58	21	34	3		
2	E	1	Total	C	H	O	0	0
			58	21	34	3		

- Molecule 3 is ACETATE ION (three-letter code: ACT) (formula: C₂H₃O₂).

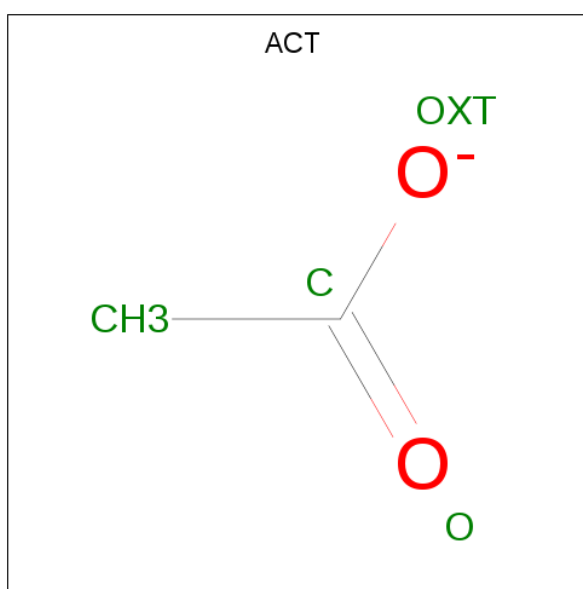

Mol	Chain	Residues	Atoms				ZeroOcc	AltConf
3	A	1	Total	C	H	O	0	0
			7	2	3	2		
3	B	1	Total	C	H	O	0	0
			7	2	3	2		
3	C	1	Total	C	H	O	0	0
			7	2	3	2		
3	D	1	Total	C	H	O	0	0
			7	2	3	2		
3	E	1	Total	C	H	O	0	0
			7	2	3	2		

- Molecule 4 is CHLORIDE ION (three-letter code: CL) (formula: Cl).

Mol	Chain	Residues	Atoms		ZeroOcc	AltConf
4	A	1	Total 1	Cl 1	0	0
4	D	1	Total 1	Cl 1	0	0

3 Residue-property plots

These plots are drawn for all protein, RNA and DNA chains in the entry. The first graphic for a chain summarises the proportions of the various outlier classes displayed in the second graphic. The second graphic shows the sequence view annotated by issues in geometry and electron density. Residues are color-coded according to the number of geometric quality criteria for which they contain at least one outlier: green = 0, yellow = 1, orange = 2 and red = 3 or more. A red dot above a residue indicates a poor fit to the electron density ($RSRZ > 2$). Stretches of 2 or more consecutive residues without any outlier are shown as a green connector. Residues present in the sample, but not in the model, are shown in grey.

- Molecule 1: Proton-gated ion channel, Gamma-aminobutyric acid receptor subunit alpha-1, Gamma-aminobutyric acid receptor subunit alpha-1

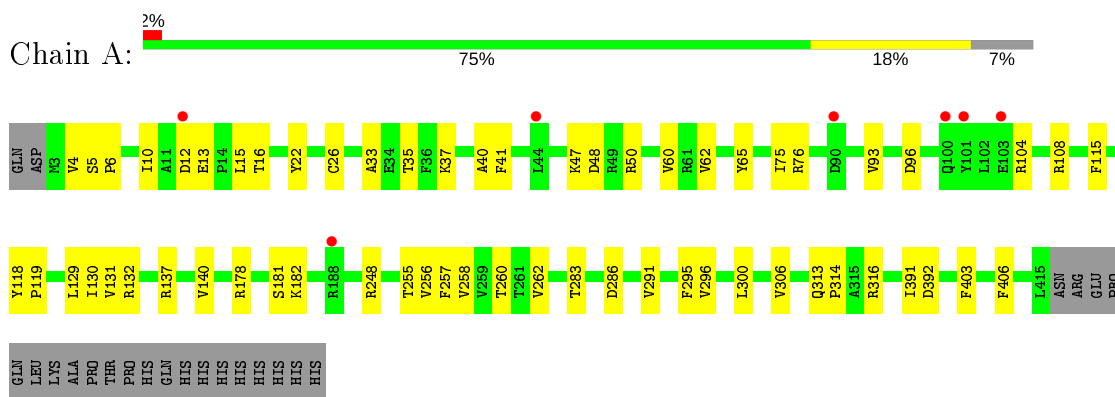

- Molecule 1: Proton-gated ion channel, Gamma-aminobutyric acid receptor subunit alpha-1, Gamma-aminobutyric acid receptor subunit alpha-1

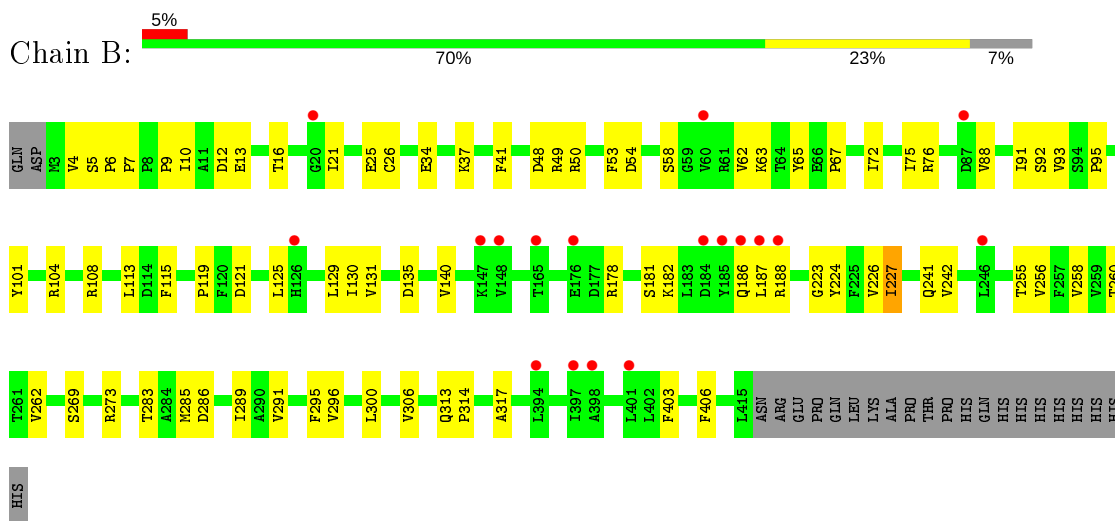

- Molecule 1: Proton-gated ion channel, Gamma-aminobutyric acid receptor subunit alpha-1, Gamma-aminobutyric acid receptor subunit alpha-1



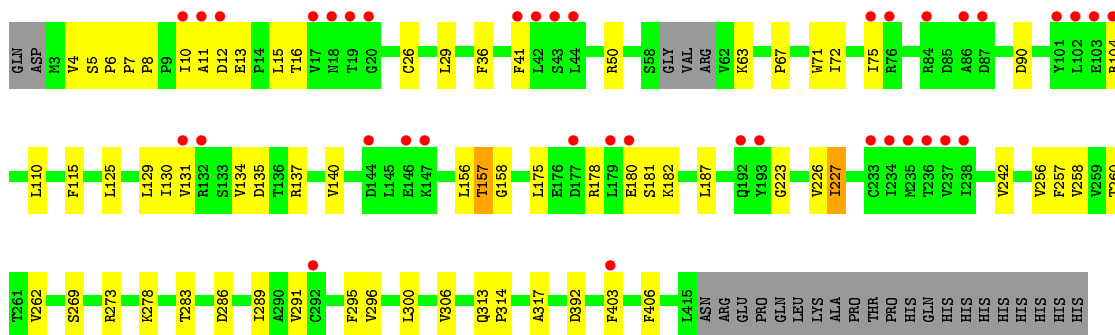

- Molecule 1: Proton-gated ion channel, Gamma-aminobutyric acid receptor subunit alpha-1, Gamma-aminobutyric acid receptor subunit alpha-1

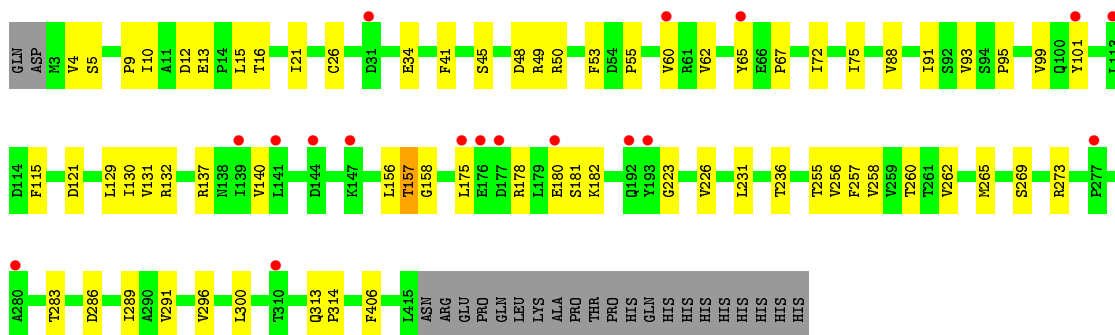

- Molecule 1: Proton-gated ion channel, Gamma-aminobutyric acid receptor subunit alpha-1, Gamma-aminobutyric acid receptor subunit alpha-1

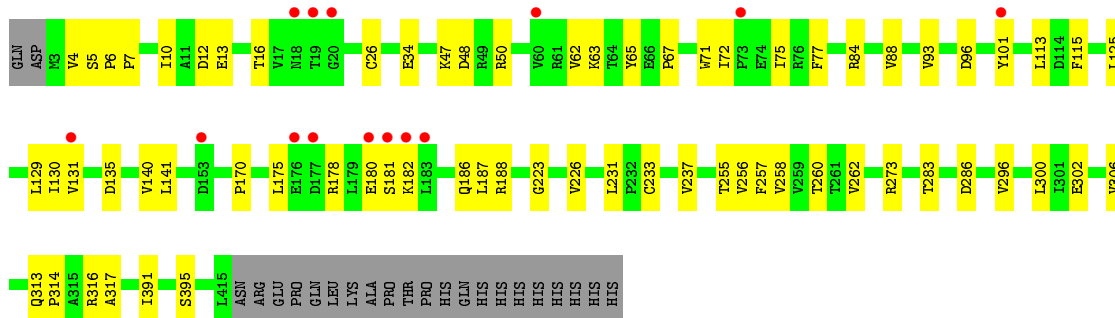

4 Data and refinement statistics

Property	Value	Source
Space group	C 1 2 1	Depositor
Cell constants a, b, c, α , β , γ	185.22Å 133.51Å 162.26Å 90.00° 103.41° 90.00°	Depositor
Resolution (Å)	29.98 – 3.80 87.46 – 3.80	Depositor EDS
% Data completeness (in resolution range)	97.2 (29.98-3.80) 99.4 (87.46-3.80)	Depositor EDS
R_{merge}	0.18	Depositor
R_{sym}	(Not available)	Depositor
$\langle I/\sigma(I) \rangle$ ¹	2.26 (at 3.78Å)	Xtrriage
Refinement program	PHENIX 1.11.1_2575	Depositor
R, R_{free}	0.241 , 0.290 0.242 , 0.297	Depositor DCC
R_{free} test set	1943 reflections (5.14%)	wwPDB-VP
Wilson B-factor (Å ²)	91.0	Xtrriage
Anisotropy	0.771	Xtrriage
Bulk solvent k_{sol} (e/Å ³), B_{sol} (Å ²)	0.26 , 100.6	EDS
L-test for twinning ²	$\langle L \rangle = 0.45$, $\langle L^2 \rangle = 0.29$	Xtrriage
Estimated twinning fraction	No twinning to report.	Xtrriage
F_o, F_c correlation	0.82	EDS
Total number of atoms	12746	wwPDB-VP
Average B, all atoms (Å ²)	189.0	wwPDB-VP

Xtrriage's analysis on translational NCS is as follows: *The largest off-origin peak in the Patterson function is 5.41% of the height of the origin peak. No significant pseudotranslation is detected.*

¹Intensities estimated from amplitudes.

²Theoretical values of $\langle |L| \rangle$, $\langle L^2 \rangle$ for acentric reflections are 0.5, 0.333 respectively for untwinned datasets, and 0.375, 0.2 for perfectly twinned datasets.

5 Model quality [i](#)

5.1 Standard geometry [i](#)

Bond lengths and bond angles in the following residue types are not validated in this section: A8Z, CL, ACT

The Z score for a bond length (or angle) is the number of standard deviations the observed value is removed from the expected value. A bond length (or angle) with $|Z| > 5$ is considered an outlier worth inspection. RMSZ is the root-mean-square of all Z scores of the bond lengths (or angles).

Mol	Chain	Bond lengths		Bond angles	
		RMSZ	# Z >5	RMSZ	# Z >5
1	A	0.24	0/2550	0.40	0/3495
1	B	0.24	0/2556	0.40	0/3502
1	C	0.24	0/2537	0.40	0/3474
1	D	0.24	0/2550	0.40	0/3495
1	E	0.24	0/2550	0.40	0/3495
All	All	0.24	0/12743	0.40	0/17461

There are no bond length outliers.

There are no bond angle outliers.

There are no chirality outliers.

There are no planarity outliers.

5.2 Too-close contacts [i](#)

In the following table, the Non-H and H(model) columns list the number of non-hydrogen atoms and hydrogen atoms in the chain respectively. The H(added) column lists the number of hydrogen atoms added and optimized by MolProbity. The Clashes column lists the number of clashes within the asymmetric unit, whereas Symm-Clashes lists symmetry related clashes.

Mol	Chain	Non-H	H(model)	H(added)	Clashes	Symm-Clashes
1	A	2485	0	2443	39	0
1	B	2491	0	2454	60	0
1	C	2473	0	2439	57	0
1	D	2485	0	2443	51	0
1	E	2485	0	2443	52	0
2	A	48	68	0	0	0
2	B	24	34	0	2	0
2	C	24	34	0	1	0

Continued on next page...

Continued from previous page...

Mol	Chain	Non-H	H(model)	H(added)	Clashes	Symm-Clashes
2	E	24	34	0	0	0
3	A	4	3	3	1	0
3	B	4	3	3	2	0
3	C	4	3	3	1	0
3	D	4	3	3	1	0
3	E	4	3	3	1	0
4	A	1	0	0	0	0
4	D	1	0	0	0	0
All	All	12561	185	12237	244	0

The all-atom clashscore is defined as the number of clashes found per 1000 atoms (including hydrogen atoms). The all-atom clashscore for this structure is 10.

All (244) close contacts within the same asymmetric unit are listed below, sorted by their clash magnitude.

Atom-1	Atom-2	Interatomic distance (Å)	Clash overlap (Å)
1:B:76:ARG:NH1	3:B:502:ACT:O	2.20	0.74
1:B:10:ILE:HB	1:B:13:GLU:HB2	1.71	0.72
1:B:227:ILE:HD11	1:C:273:ARG:CZ	2.20	0.71
1:D:88:VAL:HG22	1:D:101:TYR:OH	1.91	0.70
1:D:48:ASP:OD1	1:D:50:ARG:HD3	1.90	0.70
1:D:9:PRO:HG3	1:D:49:ARG:CZ	2.23	0.69
1:D:130:ILE:HD13	3:D:501:ACT:H2	1.76	0.68
1:D:156:LEU:O	1:D:158:GLY:N	2.27	0.67
1:D:55:PRO:HG3	1:D:95:PRO:HB3	1.77	0.67
1:C:156:LEU:O	1:C:158:GLY:N	2.29	0.65
1:E:10:ILE:HB	1:E:13:GLU:HB2	1.79	0.64
1:B:88:VAL:HG22	1:B:101:TYR:OH	1.98	0.64
1:B:256:VAL:O	1:B:260:THR:HG23	1.98	0.63
1:B:62:VAL:HG23	1:B:63:LYS:N	2.15	0.62
1:B:10:ILE:O	1:B:10:ILE:HG22	1.99	0.62
1:E:129:LEU:O	1:E:182:LYS:HA	1.99	0.61
1:B:306:VAL:HG13	1:B:317:ALA:HB1	1.82	0.61
1:E:62:VAL:HG23	1:E:63:LYS:N	2.16	0.61
1:B:130:ILE:HD13	3:B:502:ACT:H2	1.83	0.60
1:C:227:ILE:HD11	1:D:273:ARG:CZ	2.32	0.59
1:D:157:THR:HG21	1:E:34:GLU:OE1	2.03	0.59
1:B:48:ASP:OD1	1:B:50:ARG:HD3	2.02	0.59
1:E:48:ASP:OD1	1:E:50:ARG:HD3	2.02	0.59
1:C:16:THR:HA	1:C:140:VAL:O	2.04	0.58
1:B:65:TYR:O	1:B:91:ILE:HB	2.03	0.58

Continued on next page...

Continued from previous page...

Atom-1	Atom-2	Interatomic distance (Å)	Clash overlap (Å)
1:D:75:ILE:HD13	1:D:131:VAL:HB	1.86	0.58
1:D:130:ILE:HA	1:D:181:SER:O	2.05	0.57
1:D:55:PRO:HG3	1:D:95:PRO:CB	2.34	0.57
1:E:258:VAL:HG11	1:E:300:LEU:CD1	2.35	0.57
1:C:157:THR:HG21	1:D:34:GLU:OE1	2.04	0.57
1:C:258:VAL:HG11	1:C:300:LEU:CD1	2.35	0.57
1:C:7:PRO:HD2	1:C:50:ARG:HD2	1.87	0.57
1:E:88:VAL:HG22	1:E:101:TYR:OH	2.05	0.57
1:C:75:ILE:HD13	1:C:131:VAL:HB	1.87	0.56
1:D:62:VAL:HG13	1:D:93:VAL:O	2.05	0.56
1:D:16:THR:HA	1:D:140:VAL:O	2.05	0.56
1:B:224:TYR:CD2	1:C:278:LYS:HA	2.41	0.56
1:E:75:ILE:HD13	1:E:131:VAL:HB	1.89	0.55
1:E:175:LEU:HB3	1:E:180:GLU:HG3	1.87	0.55
1:B:129:LEU:O	1:B:182:LYS:HA	2.07	0.54
1:A:256:VAL:O	1:A:260:THR:HG23	2.07	0.54
1:B:67:PRO:HG3	1:B:88:VAL:HG11	1.90	0.54
1:E:16:THR:HA	1:E:140:VAL:O	2.07	0.54
1:D:256:VAL:O	1:D:260:THR:HG23	2.08	0.54
1:A:295:PHE:HE2	1:A:403:PHE:HA	1.71	0.54
1:A:75:ILE:HD13	1:A:131:VAL:HB	1.89	0.54
1:B:10:ILE:C	1:B:12:ASP:H	2.11	0.54
1:B:67:PRO:HA	1:B:72:ILE:HD11	1.89	0.54
1:E:10:ILE:HG22	1:E:10:ILE:O	2.08	0.54
1:B:130:ILE:HA	1:B:181:SER:O	2.08	0.54
1:C:256:VAL:O	1:C:260:THR:HG23	2.08	0.53
1:C:262:VAL:HG22	1:C:296:VAL:HG12	1.90	0.53
1:A:48:ASP:OD1	1:A:50:ARG:HD3	2.09	0.53
1:C:269:SER:HB2	1:C:289:ILE:HG21	1.89	0.53
1:A:115:PHE:O	1:A:283:THR:HG22	2.08	0.53
1:B:115:PHE:O	1:B:283:THR:HG22	2.08	0.53
1:B:92:SER:OG	1:C:135:ASP:OD2	2.22	0.53
1:D:129:LEU:O	1:D:182:LYS:HA	2.09	0.52
1:A:10:ILE:HG22	1:A:10:ILE:O	2.09	0.52
1:B:262:VAL:HG22	1:B:296:VAL:HG12	1.91	0.52
1:A:60:VAL:HG12	1:A:62:VAL:H	1.74	0.52
1:C:10:ILE:O	1:C:10:ILE:HG22	2.08	0.52
1:E:262:VAL:HG22	1:E:296:VAL:HG12	1.91	0.52
1:D:262:VAL:HG22	1:D:296:VAL:HG12	1.91	0.52
1:A:10:ILE:HB	1:A:13:GLU:HB2	1.92	0.52
1:E:130:ILE:HD13	3:E:502:ACT:H2	1.92	0.52

Continued on next page...

Continued from previous page...

Atom-1	Atom-2	Interatomic distance (Å)	Clash overlap (Å)
1:B:273:ARG:NH1	1:B:286:ASP:OD2	2.44	0.51
1:B:241:GLN:OE1	2:B:501:A8Z:O2	2.29	0.51
1:C:156:LEU:C	1:C:158:GLY:H	2.13	0.51
1:C:223:GLY:O	1:C:226:VAL:HB	2.11	0.51
1:D:156:LEU:C	1:D:158:GLY:H	2.14	0.51
1:C:15:LEU:HB2	1:C:137:ARG:CZ	2.41	0.51
1:B:186:GLN:OE1	1:B:188:ARG:NH2	2.44	0.50
1:C:129:LEU:O	1:C:182:LYS:HA	2.11	0.50
1:D:67:PRO:HG3	1:D:91:ILE:HD11	1.92	0.50
1:E:256:VAL:O	1:E:260:THR:HG23	2.11	0.50
1:D:175:LEU:HB3	1:D:180:GLU:HG3	1.92	0.50
1:A:132:ARG:CZ	1:A:178:ARG:HB2	2.40	0.50
1:D:258:VAL:HG11	1:D:300:LEU:HD12	1.93	0.50
1:B:6:PRO:HA	1:B:50:ARG:HH11	1.76	0.50
1:B:224:TYR:CE1	1:C:278:LYS:HG2	2.46	0.50
1:D:65:TYR:HE1	1:D:93:VAL:HG21	1.77	0.49
1:E:258:VAL:HG11	1:E:300:LEU:HD12	1.94	0.49
1:A:15:LEU:HB2	1:A:137:ARG:CZ	2.43	0.49
1:D:10:ILE:C	1:D:12:ASP:H	2.16	0.49
1:D:257:PHE:CE1	1:E:255:THR:HG23	2.48	0.49
1:E:4:VAL:O	1:E:50:ARG:NH2	2.43	0.49
1:D:15:LEU:HB2	1:D:137:ARG:CZ	2.42	0.49
1:E:130:ILE:HA	1:E:181:SER:O	2.11	0.49
1:A:130:ILE:HA	1:A:181:SER:O	2.12	0.49
1:B:16:THR:HA	1:B:140:VAL:O	2.12	0.49
1:C:175:LEU:HB3	1:C:180:GLU:HG3	1.95	0.49
1:E:7:PRO:HD2	1:E:50:ARG:HD2	1.94	0.49
1:B:258:VAL:HG11	1:B:300:LEU:HD12	1.92	0.49
1:C:291:VAL:HG11	1:C:406:PHE:CE1	2.48	0.49
1:E:62:VAL:HG23	1:E:63:LYS:H	1.77	0.49
1:B:37:LYS:HE3	1:B:108:ARG:HD2	1.95	0.49
1:C:295:PHE:HE2	1:C:403:PHE:HA	1.78	0.49
1:C:313:GLN:N	1:C:314:PRO:HD3	2.28	0.49
1:E:6:PRO:HA	1:E:50:ARG:HH11	1.78	0.49
1:A:258:VAL:HG11	1:A:300:LEU:CD1	2.42	0.48
1:E:302:GLU:HG3	1:E:395:SER:OG	2.13	0.48
1:A:75:ILE:CD1	1:A:131:VAL:HB	2.43	0.48
1:A:262:VAL:HG22	1:A:296:VAL:HG12	1.95	0.48
1:B:258:VAL:HG11	1:B:300:LEU:CD1	2.43	0.48
1:D:10:ILE:O	1:D:10:ILE:HG22	2.14	0.48
1:A:65:TYR:HE1	1:A:93:VAL:HG21	1.79	0.48

Continued on next page...

Continued from previous page...

Atom-1	Atom-2	Interatomic distance (Å)	Clash overlap (Å)
1:C:258:VAL:CG1	1:C:300:LEU:HD13	2.44	0.48
1:C:258:VAL:HG11	1:C:300:LEU:HD13	1.95	0.48
1:B:62:VAL:CG2	1:B:63:LYS:N	2.77	0.48
1:D:291:VAL:HG11	1:D:406:PHE:CE1	2.48	0.48
1:D:157:THR:HG22	1:D:157:THR:O	2.13	0.47
1:E:313:GLN:N	1:E:314:PRO:HD3	2.29	0.47
1:A:291:VAL:HG21	1:A:406:PHE:CE1	2.49	0.47
1:D:132:ARG:CZ	1:D:178:ARG:HB2	2.44	0.47
1:A:129:LEU:O	1:A:182:LYS:HA	2.15	0.47
1:D:60:VAL:HG12	1:D:62:VAL:H	1.80	0.47
1:A:313:GLN:N	1:A:314:PRO:HD3	2.30	0.47
1:E:115:PHE:O	1:E:283:THR:HG22	2.14	0.47
1:B:119:PRO:HD3	1:B:285:MET:HB2	1.96	0.47
1:E:67:PRO:HA	1:E:72:ILE:HD11	1.95	0.47
1:A:306:VAL:HG21	1:A:392:ASP:OD1	2.15	0.47
1:D:53:PHE:CE1	1:D:95:PRO:HA	2.50	0.46
1:A:41:PHE:CE1	1:A:104:ARG:HB2	2.50	0.46
1:E:75:ILE:CD1	1:E:131:VAL:HB	2.45	0.46
1:B:224:TYR:CD1	1:C:278:LYS:HG2	2.51	0.46
1:B:242:VAL:HG22	2:B:501:A8Z:C7	2.45	0.46
1:D:67:PRO:HA	1:D:72:ILE:HD11	1.97	0.46
1:E:4:VAL:HG22	1:E:5:SER:H	1.80	0.46
1:B:295:PHE:HE2	1:B:403:PHE:HA	1.80	0.46
1:A:16:THR:HA	1:A:140:VAL:O	2.16	0.46
1:A:258:VAL:HG11	1:A:300:LEU:HD12	1.96	0.46
1:B:65:TYR:HE2	1:B:93:VAL:HG21	1.81	0.46
1:D:258:VAL:HG11	1:D:300:LEU:CD1	2.46	0.46
1:B:9:PRO:HG3	1:B:49:ARG:HD3	1.97	0.46
1:C:273:ARG:NH1	1:C:286:ASP:OD2	2.49	0.46
1:A:33:ALA:O	1:A:35:THR:HG23	2.16	0.46
1:B:223:GLY:O	1:B:226:VAL:HB	2.16	0.46
1:C:29:LEU:HD13	1:C:36:PHE:HB3	1.98	0.46
1:C:90:ASP:OD2	1:D:178:ARG:NH1	2.36	0.46
1:D:75:ILE:CD1	1:D:131:VAL:HB	2.45	0.46
1:B:7:PRO:CD	1:B:50:ARG:HD2	2.46	0.46
1:C:283:THR:O	1:C:286:ASP:HB2	2.16	0.45
1:E:135:ASP:OD1	1:E:178:ARG:NH2	2.49	0.45
1:B:41:PHE:HE1	1:B:104:ARG:HB2	1.81	0.45
1:D:313:GLN:N	1:D:314:PRO:HD3	2.32	0.45
1:E:10:ILE:C	1:E:12:ASP:H	2.19	0.45
1:A:248:ARG:HD2	1:A:306:VAL:CG1	2.46	0.45

Continued on next page...

Continued from previous page...

Atom-1	Atom-2	Interatomic distance (Å)	Clash overlap (Å)
1:A:76:ARG:HD2	3:A:503:ACT:O	2.16	0.45
1:C:75:ILE:CD1	1:C:131:VAL:HB	2.45	0.45
1:A:283:THR:O	1:A:286:ASP:HB2	2.16	0.45
1:B:41:PHE:CE1	1:B:104:ARG:HB2	2.51	0.45
1:B:67:PRO:HG3	1:B:91:ILE:HD11	1.98	0.45
1:C:67:PRO:HA	1:C:72:ILE:HD11	1.99	0.45
1:E:7:PRO:CD	1:E:50:ARG:HD2	2.47	0.45
1:C:130:ILE:HA	1:C:181:SER:O	2.17	0.45
1:A:255:THR:HG23	1:E:257:PHE:CE1	2.52	0.45
1:A:47:LYS:HE3	1:A:96:ASP:OD2	2.17	0.45
1:B:135:ASP:OD1	1:B:178:ARG:NH2	2.50	0.45
1:C:10:ILE:HB	1:C:13:GLU:HB2	1.98	0.45
1:D:4:VAL:HG22	1:D:5:SER:H	1.82	0.45
1:E:65:TYR:HE1	1:E:93:VAL:HG21	1.82	0.45
1:E:47:LYS:HE3	1:E:96:ASP:OD2	2.17	0.45
1:A:6:PRO:HA	1:A:50:ARG:NH1	2.32	0.44
1:C:41:PHE:CE1	1:C:104:ARG:HB2	2.52	0.44
1:D:223:GLY:O	1:D:226:VAL:HB	2.17	0.44
1:C:115:PHE:O	1:C:283:THR:HG22	2.18	0.44
1:D:21:ILE:HA	1:D:41:PHE:O	2.17	0.44
1:B:227:ILE:HD11	1:C:273:ARG:NE	2.32	0.44
1:D:283:THR:O	1:D:286:ASP:HB2	2.17	0.44
1:B:75:ILE:HD13	1:B:131:VAL:HB	2.00	0.44
1:C:8:PRO:HG2	1:C:11:ALA:HA	1.99	0.44
1:E:316:ARG:O	1:E:391:ILE:HG13	2.18	0.44
1:C:135:ASP:OD1	1:C:178:ARG:NH2	2.51	0.44
1:C:125:LEU:HD12	1:C:187:LEU:HD23	1.99	0.44
1:D:121:ASP:OD1	1:D:121:ASP:N	2.50	0.43
1:B:25:GLU:HG3	1:C:110:LEU:HD23	2.00	0.43
1:E:231:LEU:HA	1:E:231:LEU:HD23	1.88	0.43
1:E:258:VAL:CG1	1:E:300:LEU:HD13	2.48	0.43
1:B:53:PHE:CE1	1:B:95:PRO:HA	2.53	0.43
1:B:21:ILE:HA	1:B:41:PHE:O	2.18	0.43
1:C:10:ILE:C	1:C:12:ASP:H	2.21	0.43
1:E:129:LEU:HD23	1:E:129:LEU:HA	1.88	0.43
1:A:4:VAL:HG22	1:A:5:SER:H	1.83	0.43
1:C:257:PHE:CE1	1:D:255:THR:HG23	2.54	0.43
1:C:6:PRO:HD3	1:C:71:TRP:CE3	2.54	0.43
1:C:258:VAL:HG13	1:C:300:LEU:HB2	2.01	0.43
1:C:258:VAL:HG11	1:C:300:LEU:HD12	2.01	0.43
1:C:269:SER:HB2	1:C:289:ILE:CG2	2.49	0.43

Continued on next page...

Continued from previous page...

Atom-1	Atom-2	Interatomic distance (Å)	Clash overlap (Å)
1:E:141:LEU:O	1:E:170:PRO:HG3	2.18	0.43
1:B:269:SER:HB2	1:B:289:ILE:HG21	2.01	0.42
1:C:4:VAL:HG22	1:C:5:SER:H	1.84	0.42
1:E:273:ARG:NH1	1:E:286:ASP:OD2	2.52	0.42
1:C:41:PHE:HE1	1:C:104:ARG:HB2	1.84	0.42
1:D:115:PHE:O	1:D:283:THR:HG22	2.19	0.42
1:E:77:PHE:CE2	1:E:84:ARG:HD3	2.54	0.42
1:A:118:TYR:CD2	1:A:119:PRO:HA	2.54	0.42
1:B:4:VAL:HG22	1:B:5:SER:H	1.84	0.42
1:A:10:ILE:C	1:A:12:ASP:H	2.22	0.42
1:E:6:PRO:HD3	1:E:71:TRP:CE3	2.54	0.42
1:A:6:PRO:HA	1:A:50:ARG:HH11	1.84	0.42
1:A:129:LEU:HA	1:A:129:LEU:HD23	1.88	0.42
1:E:129:LEU:O	1:E:182:LYS:HG3	2.20	0.42
1:A:37:LYS:HE3	1:A:108:ARG:HD2	2.02	0.42
1:A:22:TYR:O	1:A:40:ALA:HB1	2.20	0.42
1:B:283:THR:O	1:B:286:ASP:HB2	2.20	0.42
1:E:306:VAL:HG13	1:E:317:ALA:HB1	2.01	0.42
1:B:7:PRO:HD2	1:B:50:ARG:HD2	2.01	0.42
1:E:62:VAL:CG2	1:E:63:LYS:N	2.81	0.42
1:C:306:VAL:HG21	1:C:392:ASP:OD1	2.19	0.42
1:C:242:VAL:HG22	2:C:501:A8Z:C7	2.50	0.42
1:B:41:PHE:CE2	3:C:502:ACT:H3	2.54	0.42
1:B:313:GLN:N	1:B:314:PRO:HD3	2.34	0.41
1:D:269:SER:HB2	1:D:289:ILE:HG21	2.01	0.41
1:B:291:VAL:HG11	1:B:406:PHE:CE1	2.55	0.41
1:C:157:THR:HG22	1:C:157:THR:O	2.18	0.41
1:D:231:LEU:HA	1:D:231:LEU:HD23	1.90	0.41
1:D:273:ARG:NH1	1:D:286:ASP:OD2	2.53	0.41
1:E:258:VAL:HG13	1:E:300:LEU:HB2	2.01	0.41
1:E:34:GLU:HG2	1:E:113:LEU:HG	2.02	0.41
1:D:236:THR:HG21	1:D:265:MET:HG2	2.01	0.41
1:E:125:LEU:HD12	1:E:187:LEU:HD23	2.02	0.41
1:E:223:GLY:O	1:E:226:VAL:HB	2.19	0.41
1:B:34:GLU:HG2	1:B:113:LEU:HG	2.02	0.41
1:B:54:ASP:O	1:B:58:SER:HB2	2.21	0.41
1:E:283:THR:O	1:E:286:ASP:HB2	2.21	0.41
1:E:6:PRO:HA	1:E:50:ARG:NH1	2.35	0.41
1:A:316:ARG:O	1:A:391:ILE:HG13	2.21	0.41
1:C:129:LEU:HD23	1:C:129:LEU:HA	1.87	0.41
1:D:258:VAL:HG13	1:D:300:LEU:HB2	2.02	0.41

Continued on next page...

Continued from previous page...

Atom-1	Atom-2	Interatomic distance (Å)	Clash overlap (Å)
1:E:186:GLN:OE1	1:E:188:ARG:NH2	2.54	0.41
1:E:233:CYS:O	1:E:237:VAL:HG23	2.21	0.41
1:A:257:PHE:CE1	1:B:255:THR:HG23	2.56	0.41
1:D:45:SER:HA	1:D:99:VAL:O	2.21	0.41
1:C:291:VAL:HG11	1:C:406:PHE:CZ	2.56	0.40
1:D:10:ILE:HB	1:D:13:GLU:HB2	2.03	0.40
1:C:134:VAL:HG23	1:C:137:ARG:H	1.86	0.40
1:B:121:ASP:OD1	1:B:121:ASP:N	2.50	0.40
1:C:306:VAL:HG13	1:C:317:ALA:HB1	2.02	0.40
1:A:295:PHE:CD2	1:A:403:PHE:HD1	2.38	0.40
1:B:125:LEU:HD12	1:B:187:LEU:HD23	2.04	0.40
1:B:4:VAL:O	1:B:50:ARG:NH2	2.51	0.40
1:C:6:PRO:HA	1:C:50:ARG:HH11	1.87	0.40
1:D:55:PRO:HG3	1:D:95:PRO:CG	2.52	0.40

There are no symmetry-related clashes.

5.3 Torsion angles [i](#)

5.3.1 Protein backbone [i](#)

In the following table, the Percentiles column shows the percent Ramachandran outliers of the chain as a percentile score with respect to all X-ray entries followed by that with respect to entries of similar resolution.

The Analysed column shows the number of residues for which the backbone conformation was analysed, and the total number of residues.

Mol	Chain	Analysed	Favoured	Allowed	Outliers	Percentiles	
1	A	311/336 (93%)	299 (96%)	12 (4%)	0	100	100
1	B	311/336 (93%)	299 (96%)	12 (4%)	0	100	100
1	C	306/336 (91%)	294 (96%)	10 (3%)	2 (1%)	22	60
1	D	311/336 (93%)	299 (96%)	11 (4%)	1 (0%)	41	74
1	E	311/336 (93%)	299 (96%)	12 (4%)	0	100	100
All	All	1550/1680 (92%)	1490 (96%)	57 (4%)	3 (0%)	47	79

All (3) Ramachandran outliers are listed below:

Mol	Chain	Res	Type
1	C	157	THR
1	D	157	THR
1	C	63	LYS

5.3.2 Protein sidechains [i](#)

In the following table, the Percentiles column shows the percent sidechain outliers of the chain as a percentile score with respect to all X-ray entries followed by that with respect to entries of similar resolution.

The Analysed column shows the number of residues for which the sidechain conformation was analysed, and the total number of residues.

Mol	Chain	Analysed	Rotameric	Outliers	Percentiles	
1	A	270/302 (89%)	269 (100%)	1 (0%)	91	95
1	B	271/302 (90%)	269 (99%)	2 (1%)	84	91
1	C	270/302 (89%)	268 (99%)	2 (1%)	84	91
1	D	270/302 (89%)	269 (100%)	1 (0%)	91	95
1	E	270/302 (89%)	269 (100%)	1 (0%)	91	95
All	All	1351/1510 (90%)	1344 (100%)	7 (0%)	88	94

All (7) residues with a non-rotameric sidechain are listed below:

Mol	Chain	Res	Type
1	A	26	CYS
1	B	26	CYS
1	B	227	ILE
1	C	26	CYS
1	C	227	ILE
1	D	26	CYS
1	E	26	CYS

Some sidechains can be flipped to improve hydrogen bonding and reduce clashes. There are no such sidechains identified.

5.3.3 RNA [i](#)

There are no RNA molecules in this entry.

5.4 Non-standard residues in protein, DNA, RNA chains [i](#)

There are no non-standard protein/DNA/RNA residues in this entry.

5.5 Carbohydrates [i](#)

There are no carbohydrates in this entry.

5.6 Ligand geometry [i](#)

Of 12 ligands modelled in this entry, 2 are monoatomic - leaving 10 for Mogul analysis.

In the following table, the Counts columns list the number of bonds (or angles) for which Mogul statistics could be retrieved, the number of bonds (or angles) that are observed in the model and the number of bonds (or angles) that are defined in the Chemical Component Dictionary. The Link column lists molecule types, if any, to which the group is linked. The Z score for a bond length (or angle) is the number of standard deviations the observed value is removed from the expected value. A bond length (or angle) with $|Z| > 2$ is considered an outlier worth inspection. RMSZ is the root-mean-square of all Z scores of the bond lengths (or angles).

Mol	Type	Chain	Res	Link	Bond lengths			Bond angles		
					Counts	RMSZ	# Z > 2	Counts	RMSZ	# Z > 2
3	ACT	A	503	-	1,3,3	1.30	0	0,3,3	0.00	-
2	A8Z	E	501	-	27,27,27	0.27	0	42,43,43	0.61	2 (4%)
3	ACT	D	501	-	1,3,3	1.31	0	0,3,3	0.00	-
2	A8Z	A	501	-	27,27,27	0.27	0	42,43,43	0.64	2 (4%)
2	A8Z	B	501	-	27,27,27	0.25	0	42,43,43	0.64	2 (4%)
3	ACT	C	502	-	1,3,3	1.33	0	0,3,3	0.00	-
3	ACT	E	502	-	1,3,3	1.33	0	0,3,3	0.00	-
3	ACT	B	502	-	1,3,3	1.28	0	0,3,3	0.00	-
2	A8Z	C	501	-	27,27,27	0.26	0	42,43,43	0.64	2 (4%)
2	A8Z	A	502	-	27,27,27	0.26	0	42,43,43	0.60	2 (4%)

In the following table, the Chirals column lists the number of chiral outliers, the number of chiral centers analysed, the number of these observed in the model and the number defined in the Chemical Component Dictionary. Similar counts are reported in the Torsion and Rings columns. '2' means no outliers of that kind were identified.

Mol	Type	Chain	Res	Link	Chirals	Torsions	Rings
2	A8Z	E	501	-	-	2/6/64/64	0/4/4/4
2	A8Z	A	501	-	-	0/6/64/64	0/4/4/4
2	A8Z	B	501	-	-	2/6/64/64	0/4/4/4

Continued on next page...

Continued from previous page...

Mol	Type	Chain	Res	Link	Chirals	Torsions	Rings
2	A8Z	C	501	-	-	1/6/64/64	0/4/4/4
2	A8Z	A	502	-	-	2/6/64/64	0/4/4/4

There are no bond length outliers.

All (10) bond angle outliers are listed below:

Mol	Chain	Res	Type	Atoms	Z	Observed(°)	Ideal(°)
2	B	501	A8Z	C13-C17-C20	-2.82	111.42	115.47
2	A	501	A8Z	C13-C17-C20	-2.78	111.49	115.47
2	C	501	A8Z	C13-C17-C20	-2.76	111.50	115.47
2	C	501	A8Z	O1-C21-C20	-2.61	105.64	112.66
2	A	501	A8Z	O1-C21-C20	-2.56	105.78	112.66
2	E	501	A8Z	O1-C21-C20	-2.52	105.88	112.66
2	A	502	A8Z	O1-C21-C20	-2.52	105.88	112.66
2	B	501	A8Z	O1-C21-C20	-2.49	105.96	112.66
2	E	501	A8Z	C13-C17-C20	-2.48	111.91	115.47
2	A	502	A8Z	C13-C17-C20	-2.29	112.18	115.47

There are no chirality outliers.

All (7) torsion outliers are listed below:

Mol	Chain	Res	Type	Atoms
2	B	501	A8Z	O-C20-C21-O1
2	E	501	A8Z	O-C20-C21-O1
2	A	502	A8Z	O-C20-C21-O1
2	E	501	A8Z	C17-C20-C21-O1
2	B	501	A8Z	C17-C20-C21-O1
2	A	502	A8Z	C17-C20-C21-O1
2	C	501	A8Z	O-C20-C21-O1

There are no ring outliers.

7 monomers are involved in 9 short contacts:

Mol	Chain	Res	Type	Clashes	Symm-Clashes
3	A	503	ACT	1	0
3	D	501	ACT	1	0
2	B	501	A8Z	2	0
3	C	502	ACT	1	0
3	E	502	ACT	1	0
3	B	502	ACT	2	0

Continued on next page...

Continued from previous page...

Mol	Chain	Res	Type	Clashes	Symm-Clashes
2	C	501	A8Z	1	0

The following is a two-dimensional graphical depiction of Mogul quality analysis of bond lengths, bond angles, torsion angles, and ring geometry for all instances of the Ligand of Interest. In addition, ligands with molecular weight > 250 and outliers as shown on the validation Tables will also be included. For torsion angles, if less than 5% of the Mogul distribution of torsion angles is within 10 degrees of the torsion angle in question, then that torsion angle is considered an outlier. Any bond that is central to one or more torsion angles identified as an outlier by Mogul will be highlighted in the graph. For rings, the root-mean-square deviation (RMSD) between the ring in question and similar rings identified by Mogul is calculated over all ring torsion angles. If the average RMSD is greater than 60 degrees and the minimal RMSD between the ring in question and any Mogul-identified rings is also greater than 60 degrees, then that ring is considered an outlier. The outliers are highlighted in purple. The color gray indicates Mogul did not find sufficient equivalents in the CSD to analyse the geometry.

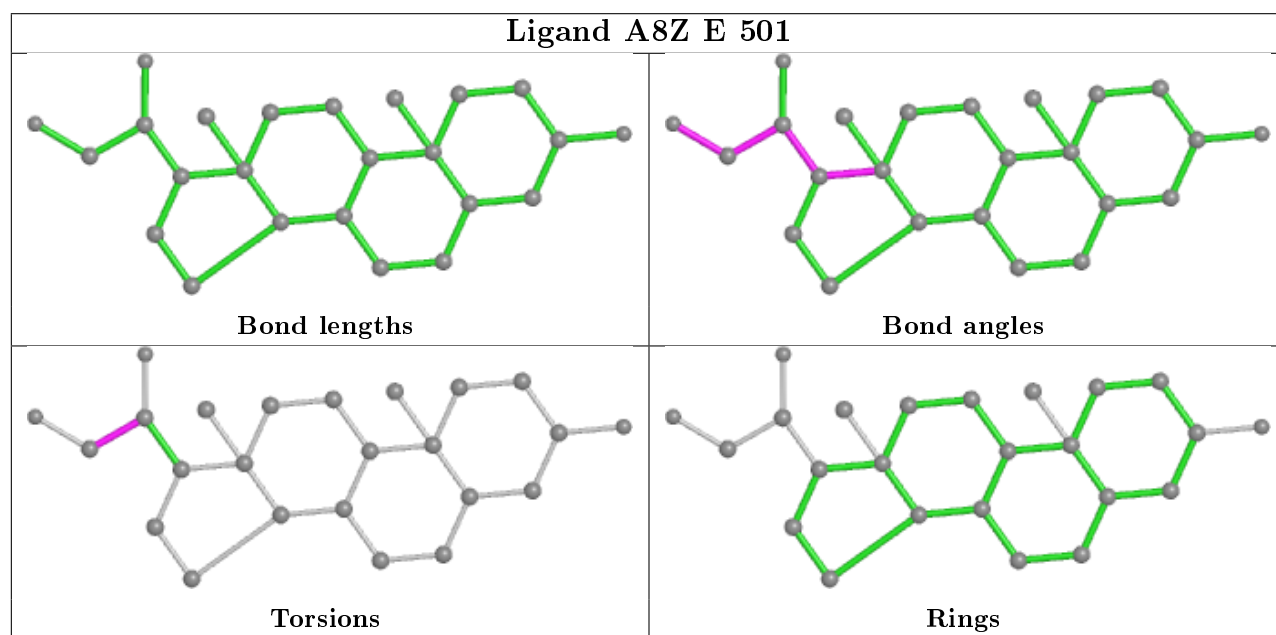

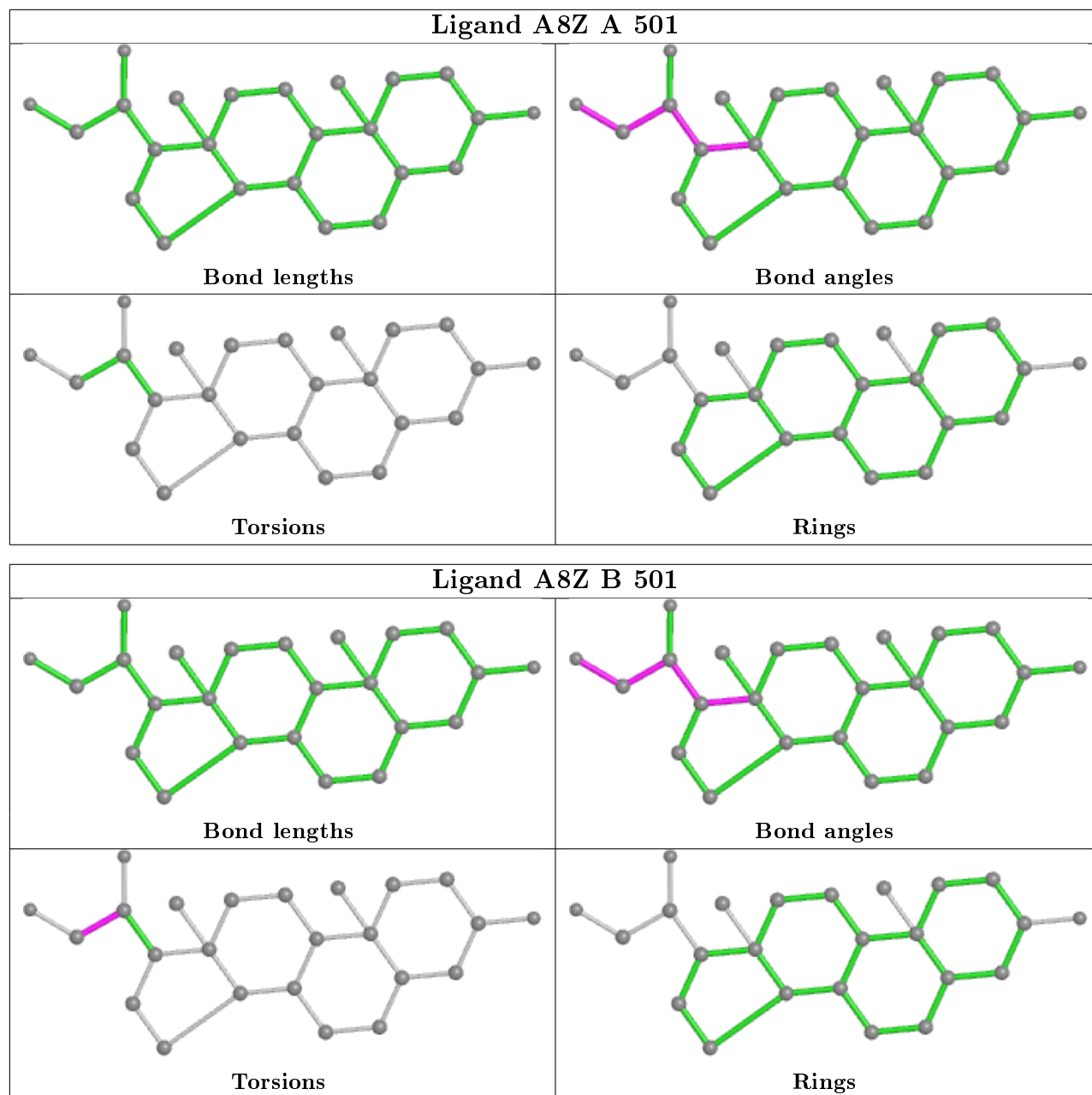

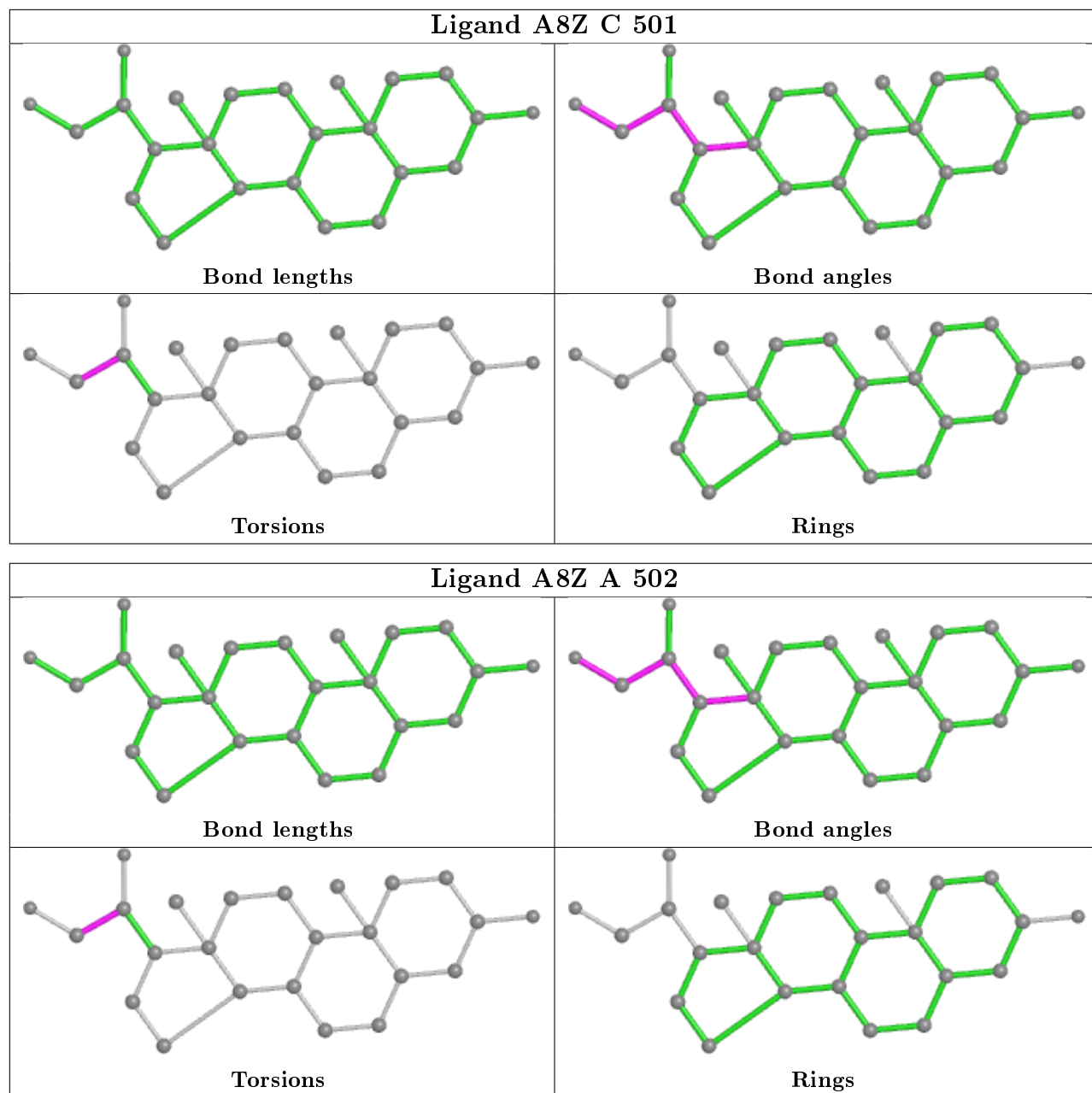

5.7 Other polymers [i](#)

There are no such residues in this entry.

5.8 Polymer linkage issues [i](#)

There are no chain breaks in this entry.

6 Fit of model and data [i](#)

6.1 Protein, DNA and RNA chains [i](#)

In the following table, the column labelled ‘#RSRZ> 2’ contains the number (and percentage) of RSRZ outliers, followed by percent RSRZ outliers for the chain as percentile scores relative to all X-ray entries and entries of similar resolution. The OWAB column contains the minimum, median, 95th percentile and maximum values of the occupancy-weighted average B-factor per residue. The column labelled ‘Q< 0.9’ lists the number of (and percentage) of residues with an average occupancy less than 0.9.

Mol	Chain	Analysed	<RSRZ>	#RSRZ>2	OWAB(Å ²)	Q<0.9
1	A	313/336 (93%)	-0.02	7 (2%) 62 54	130, 180, 227, 331	0
1	B	313/336 (93%)	0.25	18 (5%) 23 18	146, 183, 232, 325	0
1	C	310/336 (92%)	0.53	38 (12%) 4 4	79, 192, 239, 882	0
1	D	313/336 (93%)	0.37	18 (5%) 23 18	140, 183, 238, 300	0
1	E	313/336 (93%)	0.11	14 (4%) 33 28	142, 184, 238, 299	0
All	All	1562/1680 (92%)	0.25	95 (6%) 21 17	79, 184, 237, 882	0

All (95) RSRZ outliers are listed below:

Mol	Chain	Res	Type	RSRZ
1	C	20	GLY	6.1
1	C	147	LYS	5.9
1	D	147	LYS	5.8
1	C	103	GLU	5.8
1	C	19	THR	5.7
1	C	11	ALA	5.5
1	C	43	SER	5.5
1	D	176	GLU	5.3
1	B	147	LYS	5.2
1	E	177	ASP	4.7
1	C	12	ASP	4.7
1	C	42	LEU	4.6
1	A	90	ASP	4.4
1	C	177	ASP	4.4
1	B	397	ILE	4.3
1	A	101	TYR	4.2
1	E	19	THR	4.1
1	E	176	GLU	4.1
1	C	10	ILE	4.0
1	C	144	ASP	4.0

Continued on next page...

Continued from previous page...

Mol	Chain	Res	Type	RSRZ
1	C	101	TYR	3.8
1	C	132	ARG	3.7
1	B	184	ASP	3.7
1	D	177	ASP	3.5
1	D	180	GLU	3.4
1	C	235	MET	3.2
1	C	234	ILE	3.2
1	B	60	VAL	3.1
1	E	60	VAL	3.1
1	B	186	GLN	3.1
1	E	183	LEU	3.1
1	C	41	PHE	3.0
1	C	87	ASP	3.0
1	B	398	ALA	3.0
1	D	175	LEU	3.0
1	D	280	ALA	2.9
1	C	146	GLU	2.9
1	C	104	ARG	2.9
1	D	101	TYR	2.9
1	D	65	TYR	2.8
1	C	292	CYS	2.8
1	C	237	VAL	2.8
1	B	176	GLU	2.8
1	B	188	ARG	2.8
1	B	148	VAL	2.7
1	B	394	LEU	2.7
1	B	401	LEU	2.7
1	D	139	ILE	2.7
1	D	310	THR	2.6
1	C	44	LEU	2.6
1	C	180	GLU	2.6
1	D	192	GLN	2.6
1	D	141	LEU	2.5
1	C	193	TYR	2.5
1	B	187	LEU	2.5
1	E	180	GLU	2.5
1	C	18	ASN	2.5
1	D	113	LEU	2.5
1	D	60	VAL	2.5
1	C	192	GLN	2.4
1	C	236	THR	2.4
1	C	131	VAL	2.4

Continued on next page...

Continued from previous page...

Mol	Chain	Res	Type	RSRZ
1	C	238	ILE	2.4
1	C	403	PHE	2.4
1	C	179	LEU	2.4
1	A	12	ASP	2.4
1	D	31	ASP	2.4
1	D	193	TYR	2.3
1	A	188	ARG	2.3
1	B	185	TYR	2.3
1	A	103	GLU	2.3
1	C	86	ALA	2.3
1	E	182	LYS	2.3
1	E	181	SER	2.3
1	C	233	CYS	2.2
1	C	75	ILE	2.2
1	B	87	ASP	2.2
1	B	165	THR	2.2
1	E	18	ASN	2.2
1	C	102	LEU	2.2
1	D	277	PRO	2.1
1	C	17	VAL	2.1
1	E	153	ASP	2.1
1	C	76	ARG	2.1
1	C	84	ARG	2.1
1	E	20	GLY	2.1
1	E	101	TYR	2.1
1	B	246	LEU	2.1
1	B	126	HIS	2.1
1	A	100	GLN	2.1
1	E	131	VAL	2.0
1	A	44	LEU	2.0
1	B	20	GLY	2.0
1	D	144	ASP	2.0
1	E	73	PRO	2.0

6.2 Non-standard residues in protein, DNA, RNA chains [i](#)

There are no non-standard protein/DNA/RNA residues in this entry.

6.3 Carbohydrates [i](#)

There are no carbohydrates in this entry.

6.4 Ligands

In the following table, the Atoms column lists the number of modelled atoms in the group and the number defined in the chemical component dictionary. The B-factors column lists the minimum, median, 95th percentile and maximum values of B factors of atoms in the group. The column labelled 'Q<0.9' lists the number of atoms with occupancy less than 0.9.

Mol	Type	Chain	Res	Atoms	RSCC	RSR	B-factors(Å ²)	Q<0.9
2	A8Z	C	501	24/24	0.85	0.46	175,218,272,291	0
2	A8Z	B	501	24/24	0.86	0.54	176,215,284,291	0
3	ACT	D	501	4/4	0.87	1.34	168,202,293,293	0
4	CL	A	504	1/1	0.88	0.18	144,144,144,144	0
2	A8Z	E	501	24/24	0.88	0.45	171,207,234,245	0
2	A8Z	A	502	24/24	0.88	0.23	171,214,261,282	0
2	A8Z	A	501	24/24	0.89	0.40	166,198,254,274	0
3	ACT	C	502	4/4	0.90	1.09	166,184,260,260	0
3	ACT	E	502	4/4	0.92	1.07	133,156,256,256	0
3	ACT	B	502	4/4	0.93	0.83	164,167,212,212	0
3	ACT	A	503	4/4	0.93	0.34	156,177,188,193	0
4	CL	D	502	1/1	0.93	0.21	144,144,144,144	0

The following is a graphical depiction of the model fit to experimental electron density of all instances of the Ligand of Interest. In addition, ligands with molecular weight > 250 and outliers as shown on the geometry validation Tables will also be included. Each fit is shown from different orientation to approximate a three-dimensional view.

Electron density around A8Z C 501:

$2mF_o-DF_c$ (at 0.7 rmsd) in gray
 mF_o-DF_c (at 3 rmsd) in purple (negative)
and green (positive)

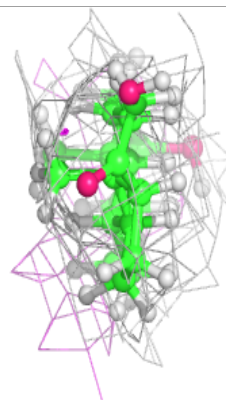
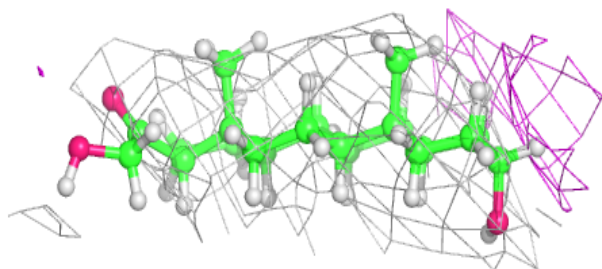
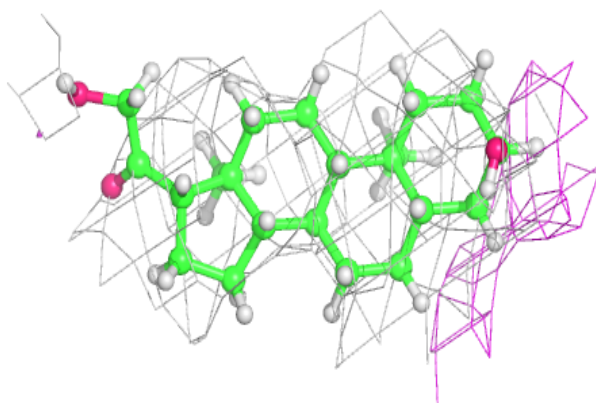
**Electron density around A8Z B 501:**

$2mF_o-DF_c$ (at 0.7 rmsd) in gray
 mF_o-DF_c (at 3 rmsd) in purple (negative)
and green (positive)

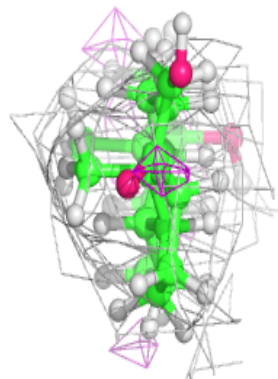
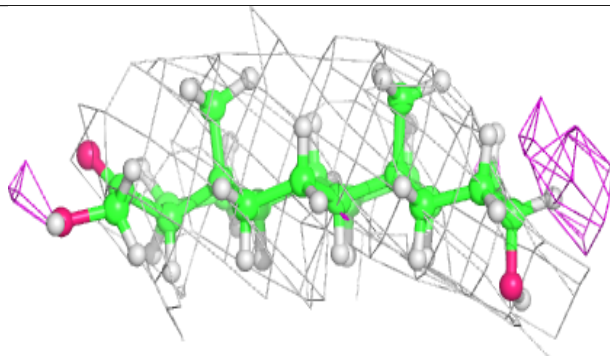
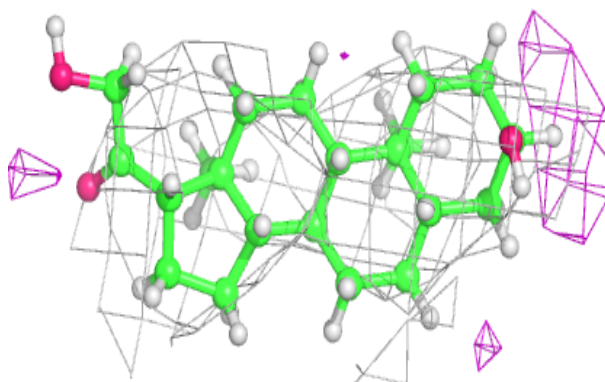

Electron density around A8Z E 501:

$2mF_o-DF_c$ (at 0.7 rmsd) in gray
 mF_o-DF_c (at 3 rmsd) in purple (negative)
and green (positive)

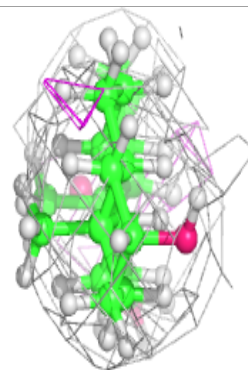
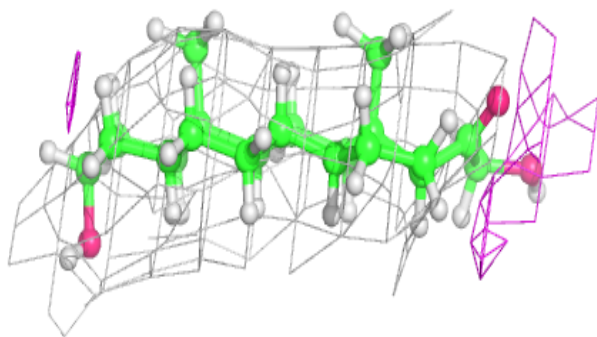
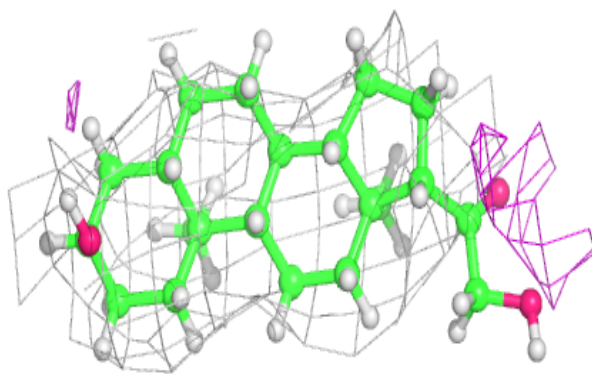
**Electron density around A8Z A 502:**

$2mF_o-DF_c$ (at 0.7 rmsd) in gray
 mF_o-DF_c (at 3 rmsd) in purple (negative)
and green (positive)

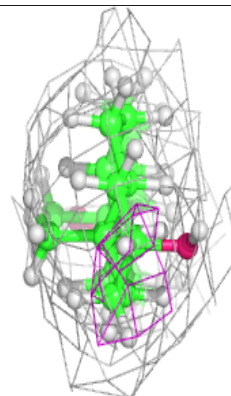
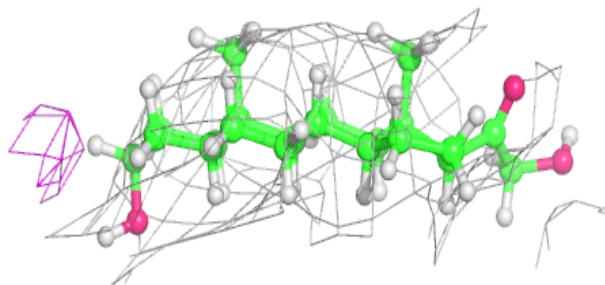
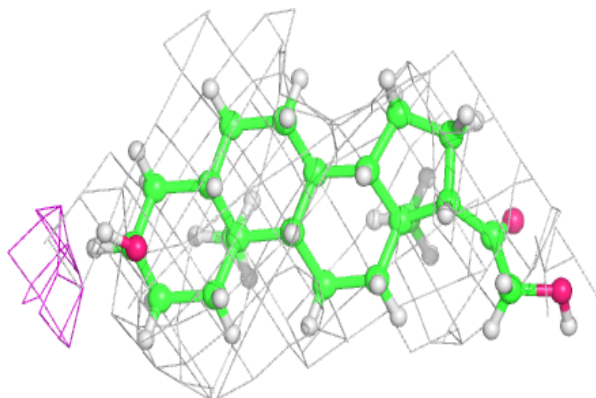

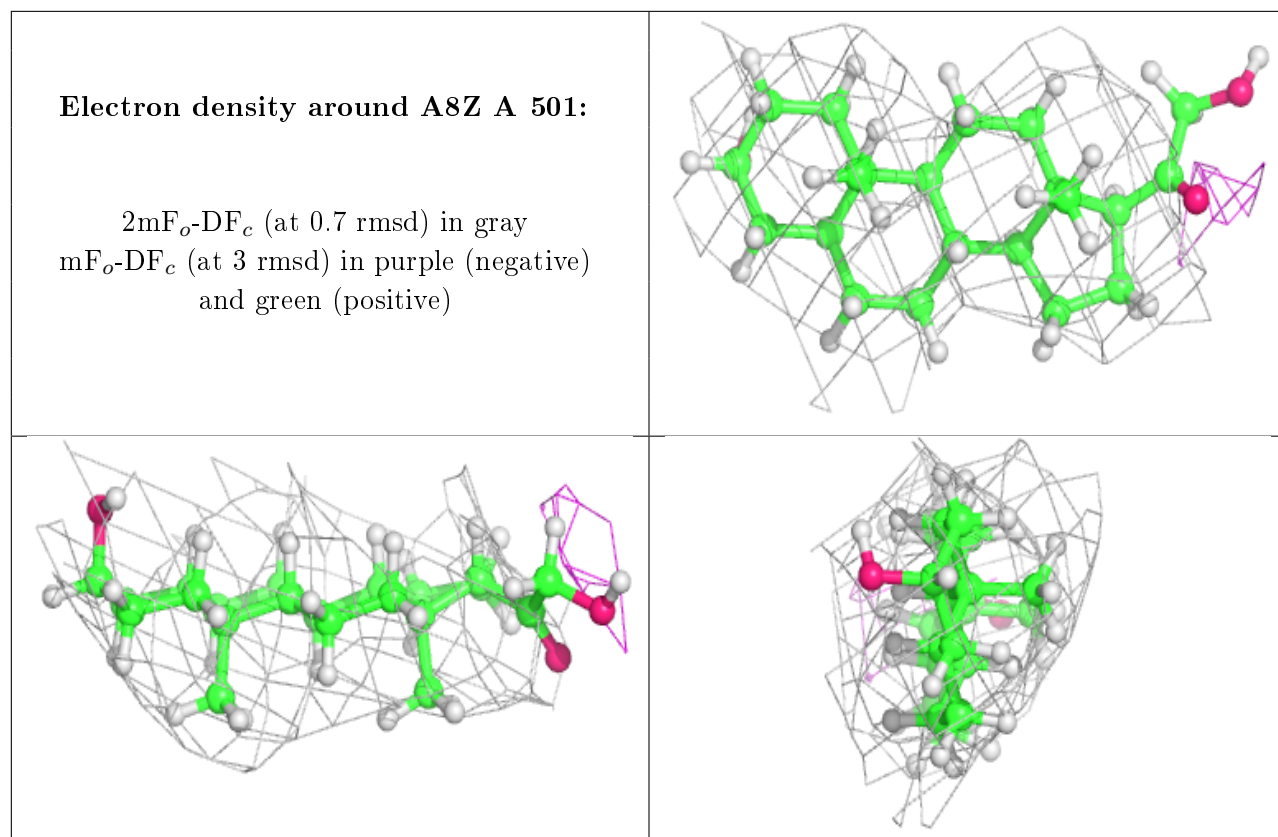

6.5 Other polymers [i](#)

There are no such residues in this entry.