



## wwPDB EM Validation Summary Report ⓘ

Nov 19, 2022 – 02:06 pm GMT

PDB ID : 5MPC  
EMDB ID : EMD-3537  
Title : 26S proteasome in presence of BeFx (s4)  
Authors : Wehmer, M.; Rudack, T.; Beck, F.; Aufderheide, A.; Pfeifer, G.; Plitzko, J.M.;  
Foerster, F.; Schulten, K.; Baumeister, W.; Sakata, E.  
Deposited on : 2016-12-16  
Resolution : 7.70 Å(reported)

This is a wwPDB EM Validation Summary Report for a publicly released PDB entry.

We welcome your comments at [validation@mail.wwpdb.org](mailto:validation@mail.wwpdb.org)

A user guide is available at

<https://www.wwpdb.org/validation/2017/EMValidationReportHelp>

with specific help available everywhere you see the ⓘ symbol.

The types of validation reports are described at

<http://www.wwpdb.org/validation/2017/FAQs#types>.

---

The following versions of software and data (see [references ⓘ](#)) were used in the production of this report:

EMDB validation analysis : 0.0.1.dev43  
Mogul : 1.8.4, CSD as541be (2020)  
MolProbity : 4.02b-467  
buster-report : 1.1.7 (2018)  
Percentile statistics : 20191225.v01 (using entries in the PDB archive December 25th 2019)  
MapQ : 1.9.9  
Ideal geometry (proteins) : Engh & Huber (2001)  
Ideal geometry (DNA, RNA) : Parkinson et al. (1996)  
Validation Pipeline (wwPDB-VP) : 2.31.2

# 1 Overall quality at a glance

The following experimental techniques were used to determine the structure:  
*ELECTRON MICROSCOPY*

The reported resolution of this entry is 7.70 Å.

Percentile scores (ranging between 0-100) for global validation metrics of the entry are shown in the following graphic. The table shows the number of entries on which the scores are based.

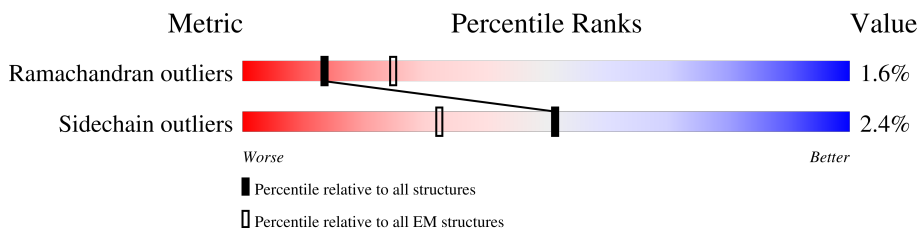

Metric	Whole archive (#Entries)	EM structures (#Entries)
Ramachandran outliers	154571	4023
Sidechain outliers	154315	3826

The table below summarises the geometric issues observed across the polymeric chains and their fit to the map. The red, orange, yellow and green segments of the bar indicate the fraction of residues that contain outliers for  $\geq 3$ , 2, 1 and 0 types of geometric quality criteria respectively. A grey segment represents the fraction of residues that are not modelled. The numeric value for each fraction is indicated below the corresponding segment, with a dot representing fractions  $\leq 5\%$ . The upper red bar (where present) indicates the fraction of residues that have poor fit to the EM map (all-atom inclusion  $< 40\%$ ). The numeric value is given above the bar.

Mol	Chain	Length	Quality of chain
1	A	252	15% (red), 73% (green), 21% (yellow), 5% (orange), 5% (grey)
1	a	252	21% (red), 72% (green), 21% (yellow), 5% (orange), 5% (grey)
2	B	250	20% (red), 81% (green), 17% (yellow), 5% (orange), 5% (grey)
2	b	250	30% (red), 78% (green), 19% (yellow), 5% (orange), 5% (grey)
3	C	258	22% (red), 72% (green), 19% (yellow), 5% (orange), 5% (grey)
3	c	258	24% (red), 69% (green), 20% (yellow), 5% (orange), 5% (grey)
4	D	254	19% (red), 70% (green), 21% (yellow), 5% (orange), 6% (grey)
4	d	254	18% (red), 70% (green), 20% (yellow), 5% (orange), 6% (grey)
5	E	260	19% (red), 73% (green), 17% (yellow), 5% (orange), 7% (grey)

*Continued on next page...*

Continued from previous page...

Mol	Chain	Length	Quality of chain
5	e	260	23% 76% 14% 7%
6	F	234	21% 76% 21%
6	f	234	21% 76% 18%
7	G	288	12% 67% 16% 16%
7	g	288	15% 63% 20% 16%
8	1	215	12% 74% 15% 9%
8	h	215	13% 71% 17% 9%
9	2	261	11% 72% 13% 13%
9	i	261	18% 72% 13% 13%
10	3	205	23% 80% 18%
10	j	205	24% 76% 21%
11	4	198	12% 77% 19%
11	k	198	13% 75% 21%
12	5	287	11% 60% 11% 26%
12	l	287	11% 60% 9% 5% 26%
13	6	241	12% 70% 20% 8%
13	m	241	12% 71% 18% 8%
14	7	266	10% 68% 14% 5% 14%
14	n	266	13% 65% 17% 5% 13%
15	H	467	26% 65% 15% 19%
16	I	437	35% 72% 15% 12%
17	K	428	34% 71% 18% 9%
18	L	437	35% 71% 14% 11%
19	M	434	28% 73% 12% 12%
20	J	405	38% 79% 17%

Continued on next page...

Continued from previous page...

Mol	Chain	Length	Quality of chain
21	W	268	
22	V	306	
23	T	274	
24	X	156	
25	Y	89	
26	Z	993	
27	N	945	
28	S	523	
29	P	445	
30	Q	434	
31	R	429	
32	U	338	
33	O	393	
34	8	499	

## 2 Entry composition [i](#)

There are 37 unique types of molecules in this entry. The entry contains 112042 atoms, of which 0 are hydrogens and 0 are deuteriums.

In the tables below, the AltConf column contains the number of residues with at least one atom in alternate conformation and the Trace column contains the number of residues modelled with at most 2 atoms.

- Molecule 1 is a protein called Proteasome subunit alpha type-1.

Mol	Chain	Residues	Atoms					AltConf	Trace
			Total	C	N	O	S		
1	a	241	Total	C	N	O	S	0	0
			1907	1214	320	365	8		
1	A	241	Total	C	N	O	S	0	0
			1907	1214	320	365	8		

- Molecule 2 is a protein called Proteasome subunit alpha type-2.

Mol	Chain	Residues	Atoms					AltConf	Trace
			Total	C	N	O	S		
2	b	250	Total	C	N	O	S	0	0
			1915	1219	315	377	4		
2	B	250	Total	C	N	O	S	0	0
			1915	1219	315	377	4		

- Molecule 3 is a protein called Proteasome subunit alpha type-3.

Mol	Chain	Residues	Atoms					AltConf	Trace
			Total	C	N	O	S		
3	c	244	Total	C	N	O	S	0	0
			1904	1201	321	379	3		
3	C	244	Total	C	N	O	S	0	0
			1904	1201	321	379	3		

- Molecule 4 is a protein called Proteasome subunit alpha type-4.

Mol	Chain	Residues	Atoms					AltConf	Trace
			Total	C	N	O	S		
4	d	240	Total	C	N	O	S	0	0
			1881	1176	329	372	4		
4	D	240	Total	C	N	O	S	0	0
			1881	1176	329	372	4		

- Molecule 5 is a protein called Proteasome subunit alpha type-5.

Mol	Chain	Residues	Atoms					AltConf	Trace
5	e	242	Total	C	N	O	S	0	0
			1861	1162	314	378	7		
5	E	242	Total	C	N	O	S	0	0
			1861	1162	314	378	7		

- Molecule 6 is a protein called Proteasome subunit alpha type-6.

Mol	Chain	Residues	Atoms					AltConf	Trace
6	f	231	Total	C	N	O	S	0	0
			1773	1114	307	348	4		
6	F	233	Total	C	N	O	S	0	0
			1795	1129	312	350	4		

- Molecule 7 is a protein called Probable proteasome subunit alpha type-7.

Mol	Chain	Residues	Atoms					AltConf	Trace
7	g	243	Total	C	N	O	S	0	0
			1892	1203	329	356	4		
7	G	243	Total	C	N	O	S	0	0
			1892	1203	329	356	4		

- Molecule 8 is a protein called Proteasome subunit beta type-1.

Mol	Chain	Residues	Atoms					AltConf	Trace
8	h	196	Total	C	N	O	S	0	0
			1512	955	250	300	7		
8	1	196	Total	C	N	O	S	0	0
			1512	955	250	300	7		

- Molecule 9 is a protein called Proteasome subunit beta type-2.

Mol	Chain	Residues	Atoms					AltConf	Trace
9	i	226	Total	C	N	O	S	0	0
			1719	1082	298	332	7		
9	2	226	Total	C	N	O	S	0	0
			1719	1082	298	332	7		

- Molecule 10 is a protein called Proteasome subunit beta type-3.

Mol	Chain	Residues	Atoms					AltConf	Trace
10	j	204	Total	C	N	O	S	0	0
			1581	1010	258	305	8		

*Continued on next page...*

*Continued from previous page...*

Mol	Chain	Residues	Atoms					AltConf	Trace
10	3	204	Total	C	N	O	S	0	0
			1581	1010	258	305	8		

- Molecule 11 is a protein called Proteasome subunit beta type-4.

Mol	Chain	Residues	Atoms					AltConf	Trace
11	k	195	Total	C	N	O	S	0	0
			1561	992	264	299	6		
11	4	195	Total	C	N	O	S	0	0
			1561	992	264	299	6		

- Molecule 12 is a protein called Proteasome subunit beta type-5.

Mol	Chain	Residues	Atoms					AltConf	Trace
12	l	212	Total	C	N	O	S	0	0
			1644	1045	280	312	7		
12	5	212	Total	C	N	O	S	0	0
			1644	1045	280	312	7		

- Molecule 13 is a protein called Proteasome subunit beta type-6.

Mol	Chain	Residues	Atoms					AltConf	Trace
13	m	222	Total	C	N	O	S	0	0
			1757	1115	303	335	4		
13	6	222	Total	C	N	O	S	0	0
			1757	1115	303	335	4		

- Molecule 14 is a protein called Proteasome subunit beta type-7.

Mol	Chain	Residues	Atoms					AltConf	Trace
14	n	232	Total	C	N	O	S	0	0
			1815	1148	311	349	7		
14	7	229	Total	C	N	O	S	0	0
			1790	1133	306	344	7		

- Molecule 15 is a protein called 26S protease regulatory subunit 7 homolog.

Mol	Chain	Residues	Atoms					AltConf	Trace
15	H	380	Total	C	N	O	S	0	0
			2967	1869	531	551	16		

- Molecule 16 is a protein called 26S protease regulatory subunit 4 homolog.

Mol	Chain	Residues	Atoms					AltConf	Trace
			Total	C	N	O	S		
16	I	385	3022	1899	508	598	17	0	0

- Molecule 17 is a protein called 26S protease regulatory subunit 6B homolog.

Mol	Chain	Residues	Atoms					AltConf	Trace
			Total	C	N	O	S		
17	K	389	3078	1933	540	595	10	0	0

- Molecule 18 is a protein called 26S protease subunit RPT4.

Mol	Chain	Residues	Atoms					AltConf	Trace
			Total	C	N	O	S		
18	L	388	3082	1942	548	580	12	0	0

- Molecule 19 is a protein called 26S protease regulatory subunit 6A.

Mol	Chain	Residues	Atoms					AltConf	Trace
			Total	C	N	O	S		
19	M	381	2986	1870	524	580	12	0	0

- Molecule 20 is a protein called 26S protease regulatory subunit 8 homolog.

Mol	Chain	Residues	Atoms					AltConf	Trace
			Total	C	N	O	S		
20	J	393	3089	1944	552	576	17	0	0

- Molecule 21 is a protein called 26S proteasome regulatory subunit RPN10.

Mol	Chain	Residues	Atoms					AltConf	Trace
			Total	C	N	O	S		
21	W	197	1534	962	269	300	3	0	0

- Molecule 22 is a protein called Ubiquitin carboxyl-terminal hydrolase RPN11.

Mol	Chain	Residues	Atoms					AltConf	Trace
			Total	C	N	O	S		
22	V	289	2274	1425	389	446	14	0	0

- Molecule 23 is a protein called 26S proteasome regulatory subunit RPN12.



Mol	Chain	Residues	Atoms					AltConf	Trace
			Total	C	N	O	S		
23	T	266	2192	1405	349	432	6	0	0

- Molecule 24 is a protein called 26S proteasome regulatory subunit RPN13.

Mol	Chain	Residues	Atoms					AltConf	Trace
			Total	C	N	O	S		
24	X	127	1032	664	169	195	4	0	0

- Molecule 25 is a protein called 26S proteasome complex subunit SEM1.

Mol	Chain	Residues	Atoms				AltConf	Trace
			Total	C	N	O		
25	Y	51	435	264	69	102		0

- Molecule 26 is a protein called 26S proteasome regulatory subunit RPN1.

Mol	Chain	Residues	Atoms					AltConf	Trace
			Total	C	N	O	S		
26	Z	906	7005	4416	1150	1409	30	0	0

- Molecule 27 is a protein called 26S proteasome regulatory subunit RPN2.

Mol	Chain	Residues	Atoms					AltConf	Trace
			Total	C	N	O	S		
27	N	890	6882	4373	1156	1325	28	0	0

- Molecule 28 is a protein called 26S proteasome regulatory subunit RPN3.

Mol	Chain	Residues	Atoms					AltConf	Trace
			Total	C	N	O	S		
28	S	475	3894	2488	653	738	15	0	0

- Molecule 29 is a protein called 26S proteasome regulatory subunit RPN5.

Mol	Chain	Residues	Atoms					AltConf	Trace
			Total	C	N	O	S		
29	P	440	3608	2297	604	697	10	0	0

- Molecule 30 is a protein called 26S proteasome regulatory subunit RPN6.

Mol	Chain	Residues	Atoms					AltConf	Trace
			Total	C	N	O	S		
30	Q	434	3499	2225	577	681	16	0	0

- Molecule 31 is a protein called 26S proteasome regulatory subunit RPN7.

Mol	Chain	Residues	Atoms					AltConf	Trace
			Total	C	N	O	S		
31	R	381	3060	1955	502	593	10	0	0

- Molecule 32 is a protein called 26S proteasome regulatory subunit RPN8.

Mol	Chain	Residues	Atoms					AltConf	Trace
			Total	C	N	O	S		
32	U	298	2373	1496	404	466	7	0	0

- Molecule 33 is a protein called 26S proteasome regulatory subunit RPN9.

Mol	Chain	Residues	Atoms					AltConf	Trace
			Total	C	N	O	S		
33	O	388	3186	2051	519	608	8	0	0

- Molecule 34 is a protein called Ubiquitin carboxyl-terminal hydrolase 6.

Mol	Chain	Residues	Atoms					AltConf	Trace
			Total	C	N	O	S		
34	8	395	3219	2029	554	623	13	0	0

- Molecule 35 is ADENOSINE-5'-TRIPHOSPHATE (three-letter code: ATP) (formula:  $C_{10}H_{16}N_5O_{13}P_3$ ).

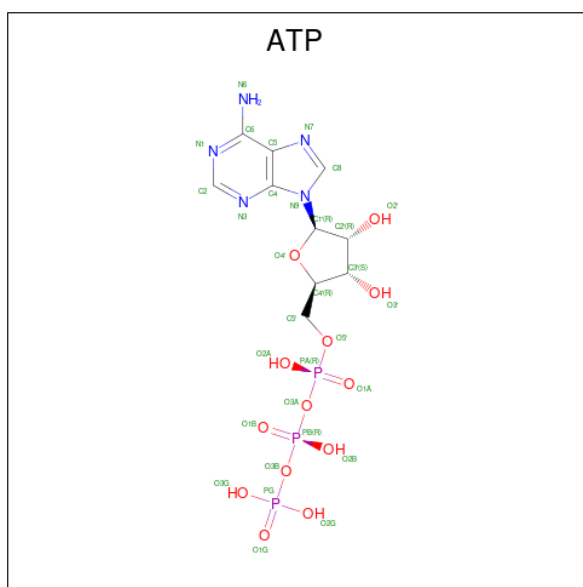

Mol	Chain	Residues	Atoms					AltConf
			Total	C	N	O	P	
35	H	1	Total	C	N	O	P	0
			31	10	5	13	3	
35	I	1	Total	C	N	O	P	0
			31	10	5	13	3	
35	M	1	Total	C	N	O	P	0
			31	10	5	13	3	
35	J	1	Total	C	N	O	P	0
			31	10	5	13	3	

- Molecule 36 is MAGNESIUM ION (three-letter code: MG) (formula: Mg).

Mol	Chain	Residues	Atoms		AltConf
			Total	Mg	
36	H	1	Total	Mg	0
			1	1	
36	I	1	Total	Mg	0
			1	1	
36	K	1	Total	Mg	0
			1	1	
36	L	1	Total	Mg	0
			1	1	
36	M	1	Total	Mg	0
			1	1	
36	J	1	Total	Mg	0
			1	1	

- Molecule 37 is ADENOSINE-5'-DIPHOSPHATE (three-letter code: ADP) (formula: C<sub>10</sub>H<sub>15</sub>N<sub>5</sub>O<sub>10</sub>P<sub>2</sub>).



Mol	Chain	Residues	Atoms					AltConf
			Total	C	N	O	P	
37	K	1	27	10	5	10	2	0
37	L	1	27	10	5	10	2	0

### 3 Residue-property plots [i](#)

These plots are drawn for all protein, RNA, DNA and oligosaccharide chains in the entry. The first graphic for a chain summarises the proportions of the various outlier classes displayed in the second graphic. The second graphic shows the sequence view annotated by issues in geometry and atom inclusion in map density. Residues are color-coded according to the number of geometric quality criteria for which they contain at least one outlier: green = 0, yellow = 1, orange = 2 and red = 3 or more. A red diamond above a residue indicates a poor fit to the EM map for this residue (all-atom inclusion < 40%). Stretches of 2 or more consecutive residues without any outlier are shown as a green connector. Residues present in the sample, but not in the model, are shown in grey.

- Molecule 1: Proteasome subunit alpha type-1

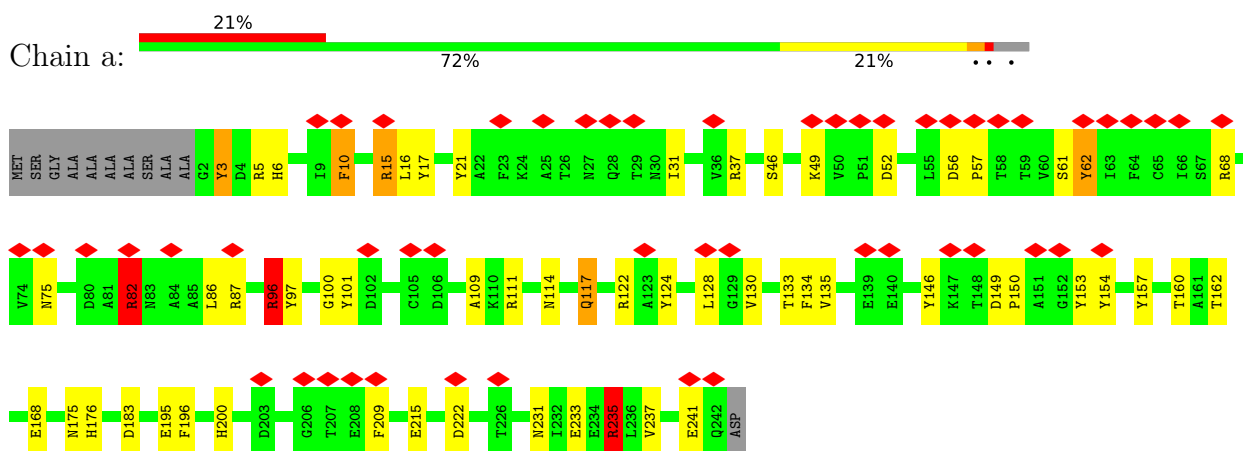

- Molecule 1: Proteasome subunit alpha type-1

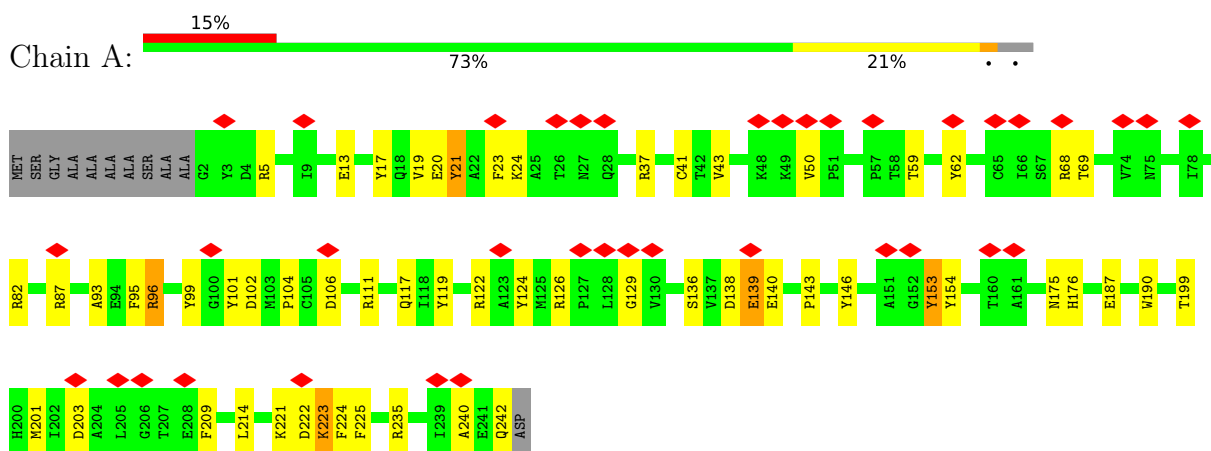

- Molecule 2: Proteasome subunit alpha type-2

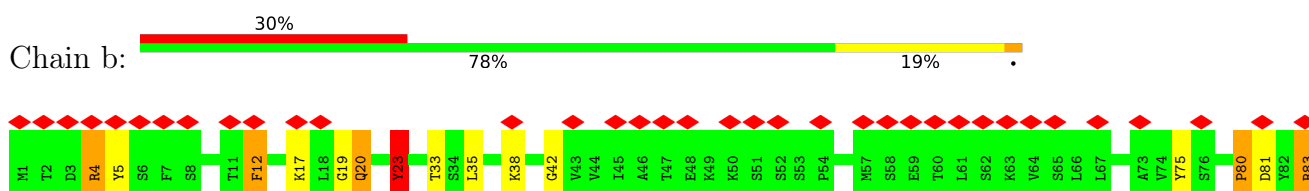

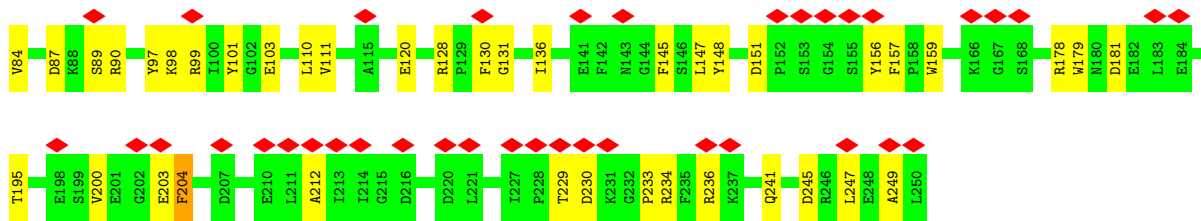

• Molecule 2: Proteasome subunit alpha type-2

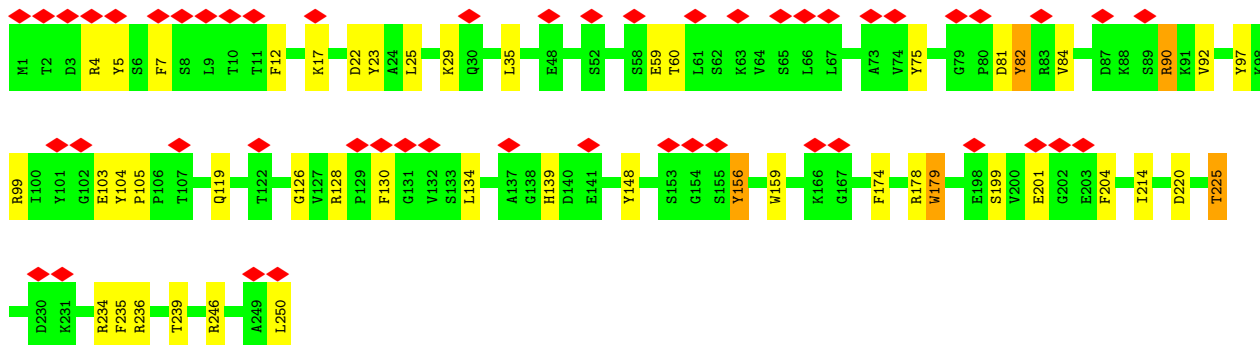
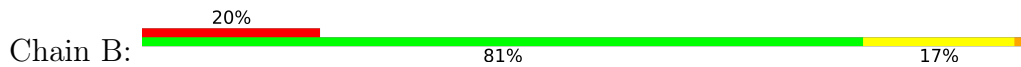

• Molecule 3: Proteasome subunit alpha type-3

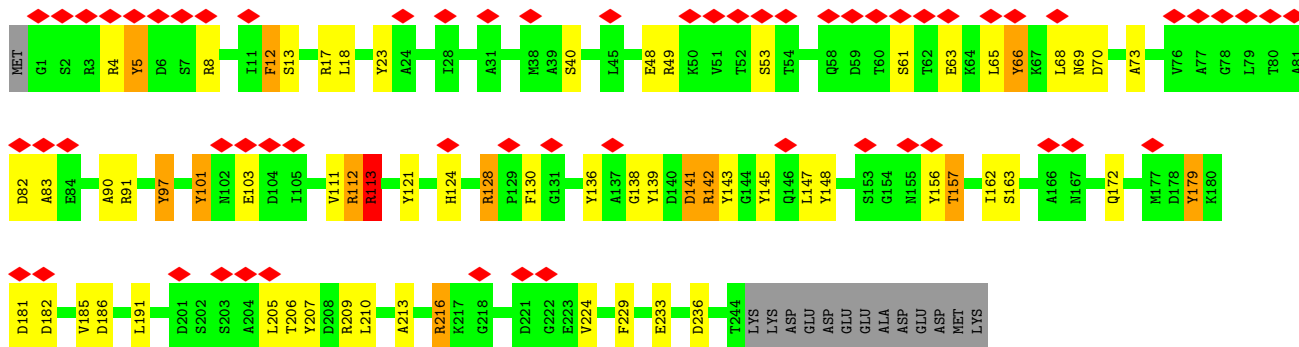

• Molecule 3: Proteasome subunit alpha type-3

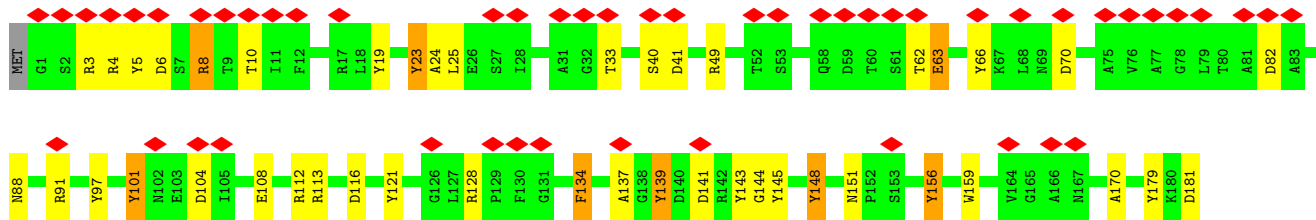
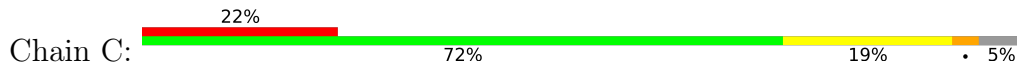

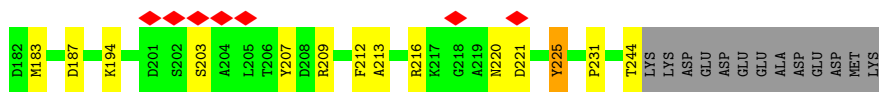

• Molecule 4: Proteasome subunit alpha type-4

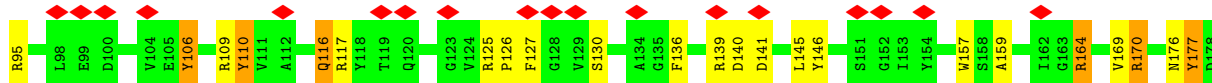
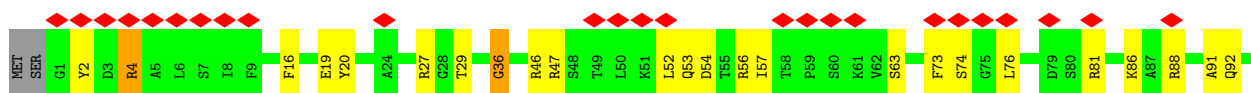

• Molecule 4: Proteasome subunit alpha type-4

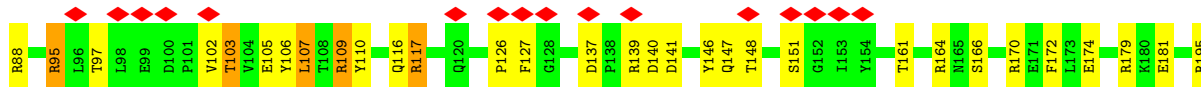

• Molecule 5: Proteasome subunit alpha type-5

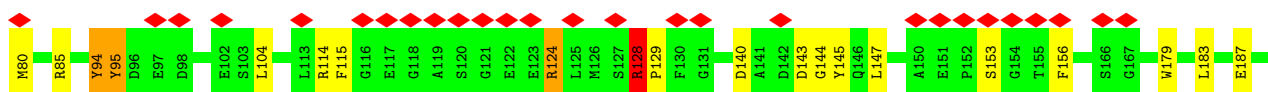
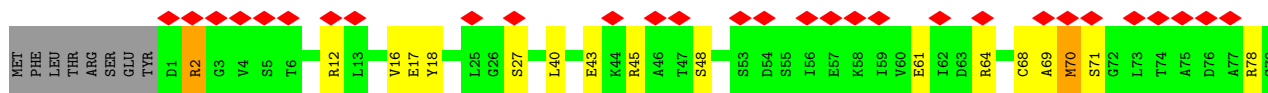
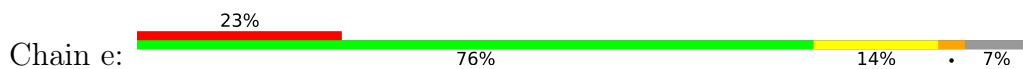

• Molecule 5: Proteasome subunit alpha type-5

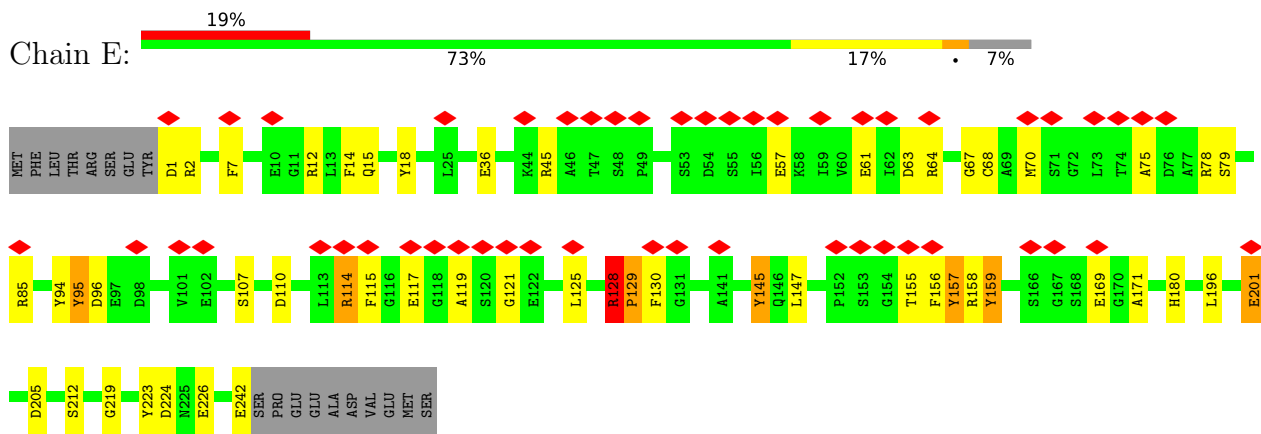

• Molecule 6: Proteasome subunit alpha type-6

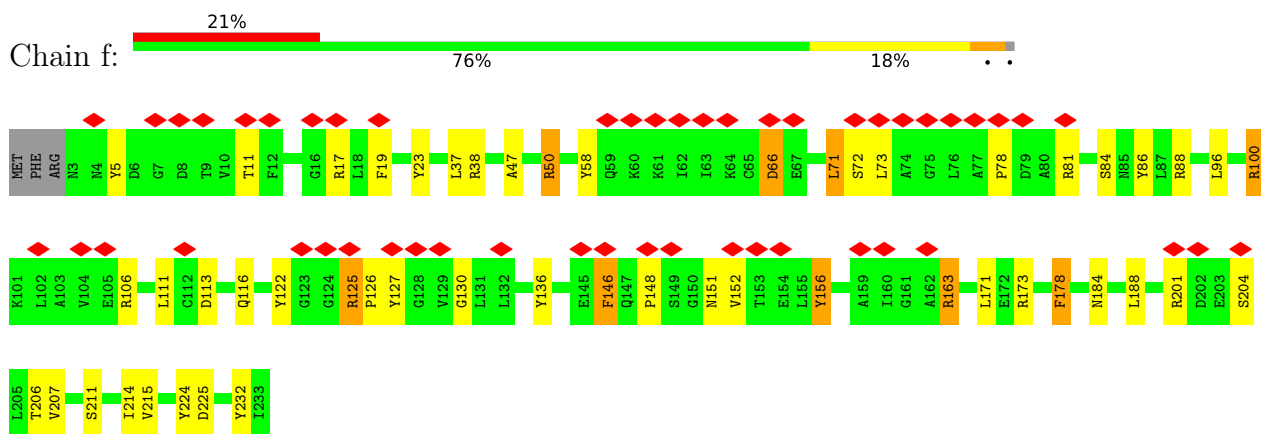

• Molecule 6: Proteasome subunit alpha type-6

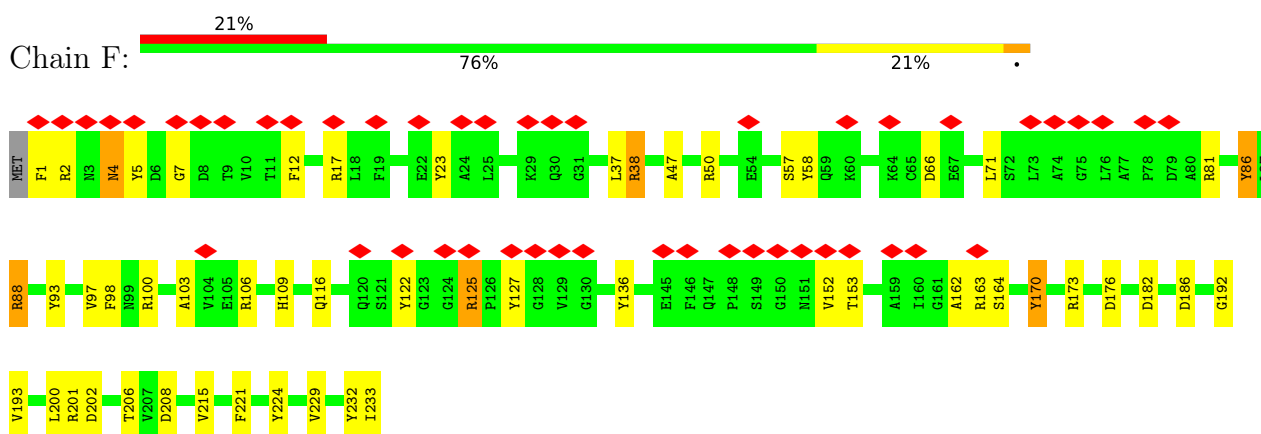

• Molecule 7: Probable proteasome subunit alpha type-7

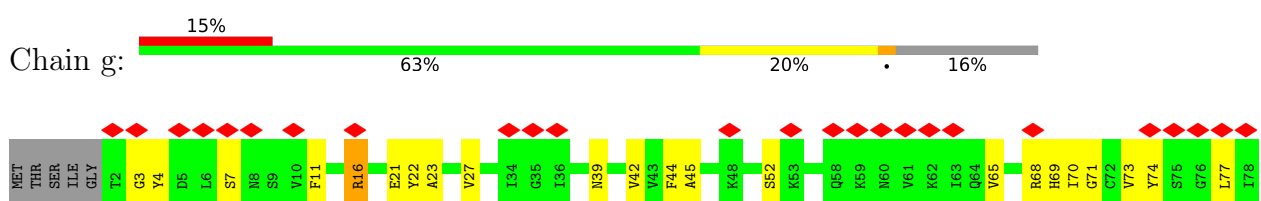



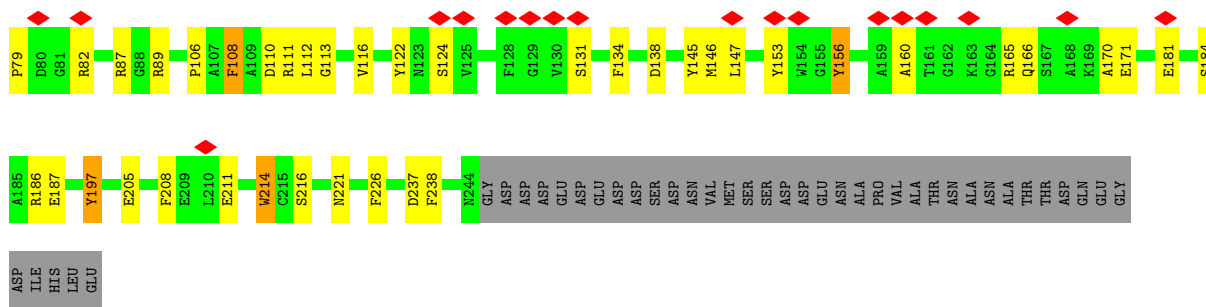

• Molecule 7: Probable proteasome subunit alpha type-7

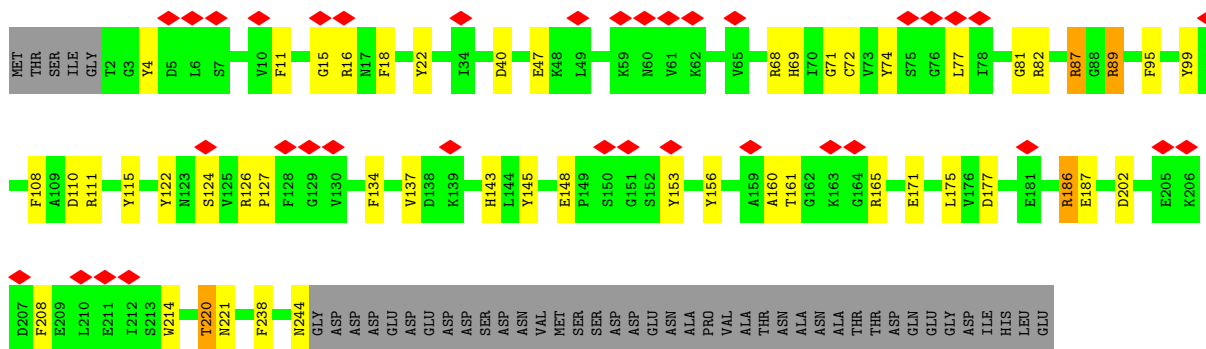

• Molecule 8: Proteasome subunit beta type-1

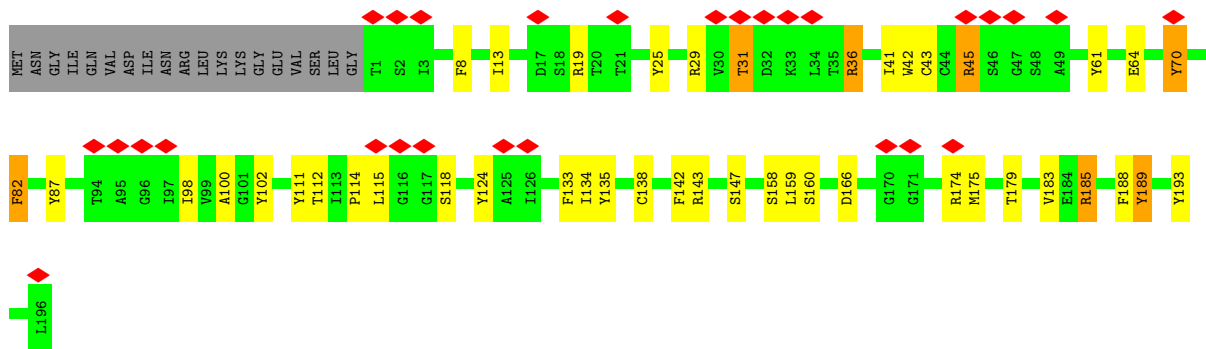

• Molecule 8: Proteasome subunit beta type-1

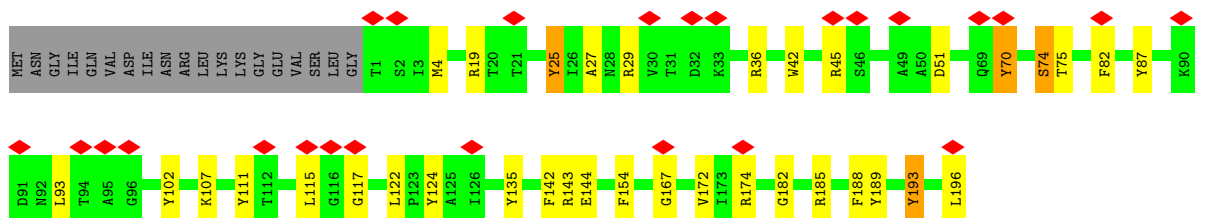

- Molecule 9: Proteasome subunit beta type-2

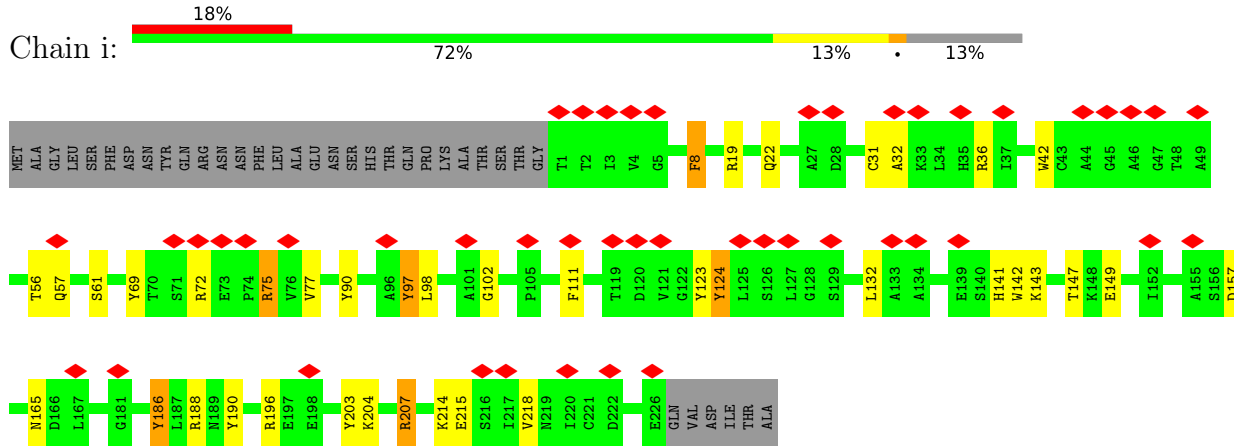

- Molecule 9: Proteasome subunit beta type-2

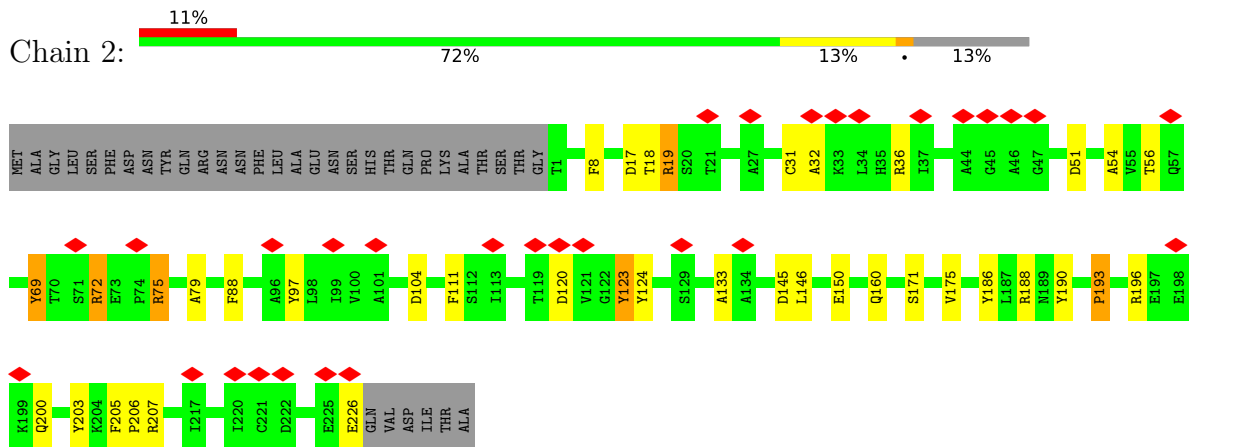

- Molecule 10: Proteasome subunit beta type-3

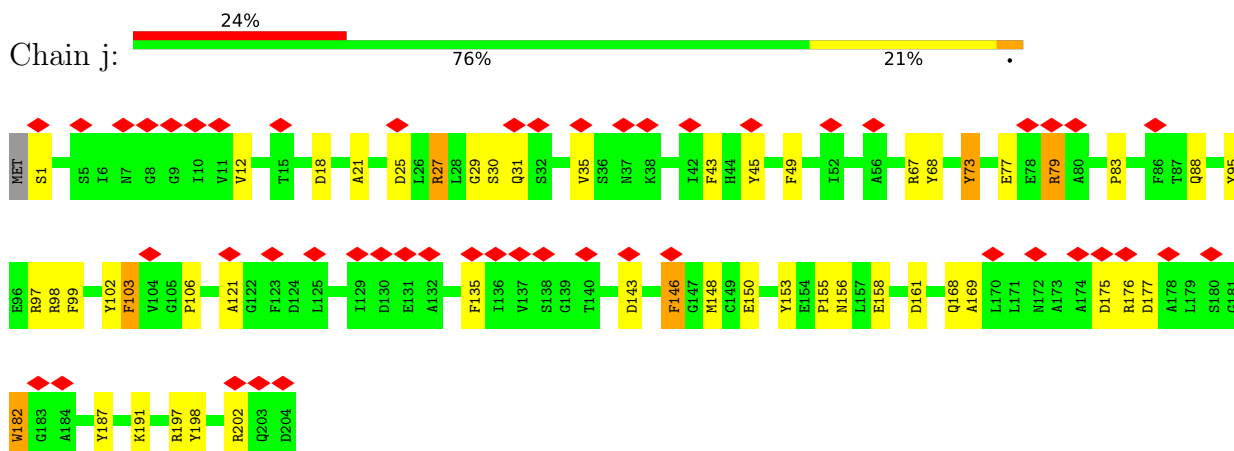

- Molecule 10: Proteasome subunit beta type-3

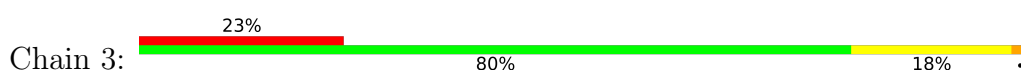

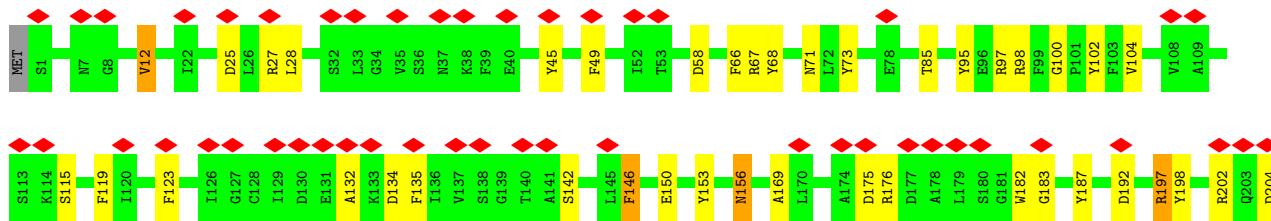

• Molecule 11: Proteasome subunit beta type-4

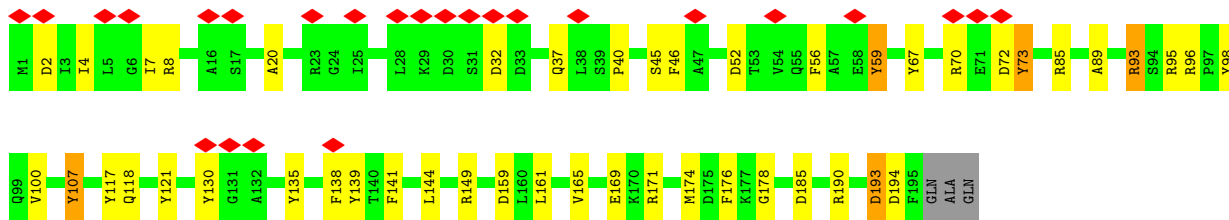
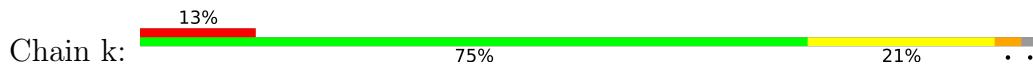

• Molecule 11: Proteasome subunit beta type-4

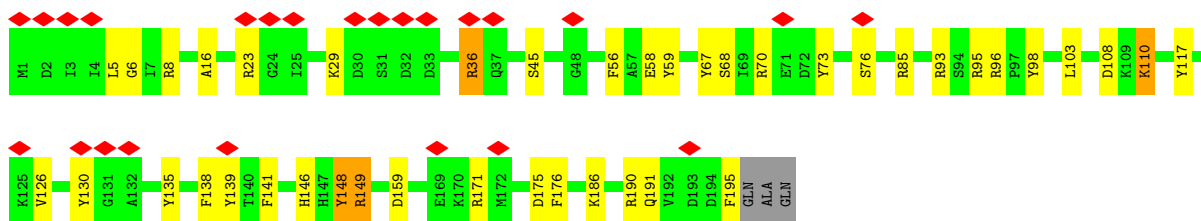
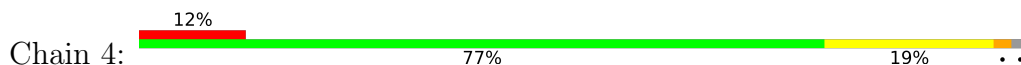

• Molecule 12: Proteasome subunit beta type-5

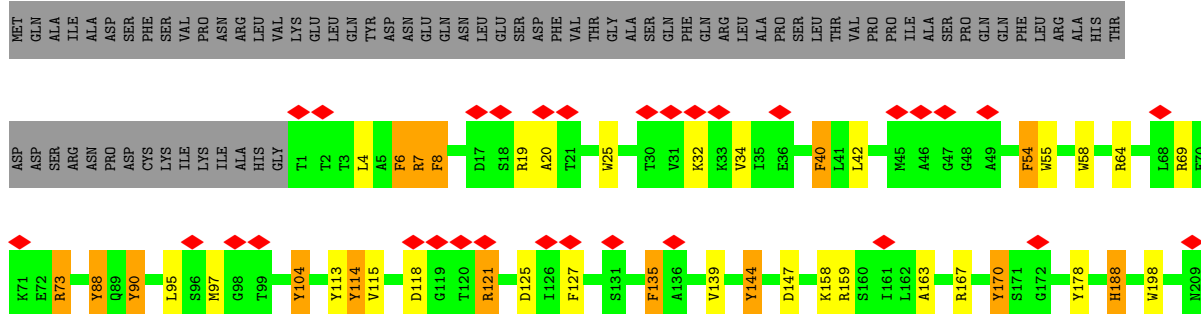

• Molecule 12: Proteasome subunit beta type-5



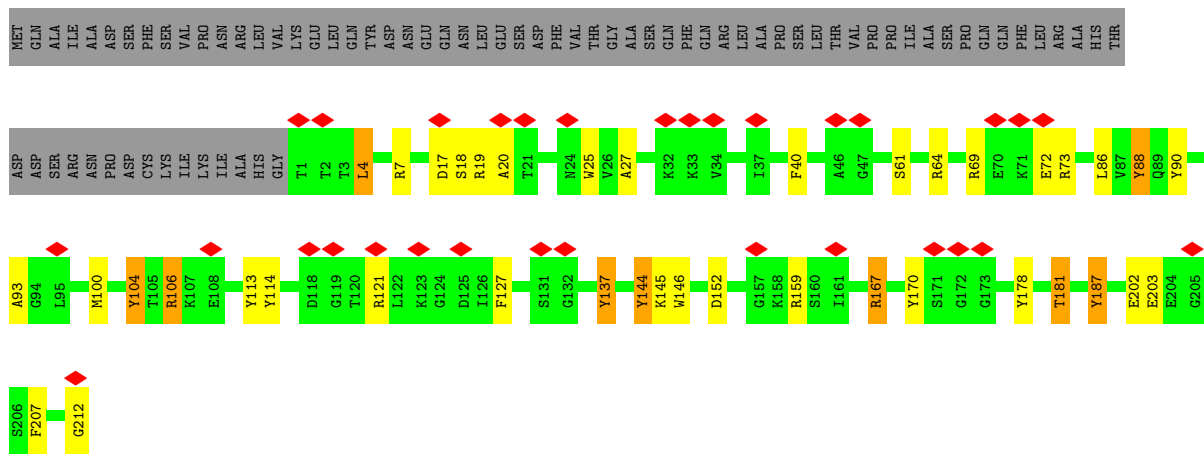

• Molecule 13: Proteasome subunit beta type-6

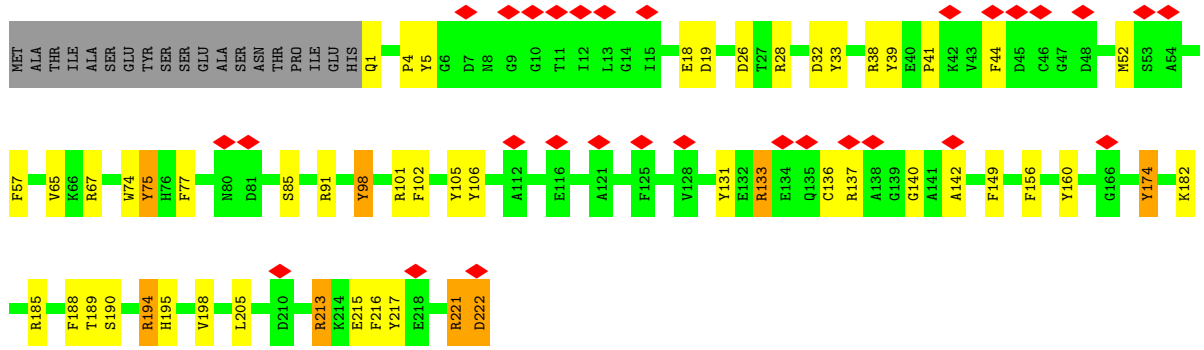

• Molecule 13: Proteasome subunit beta type-6

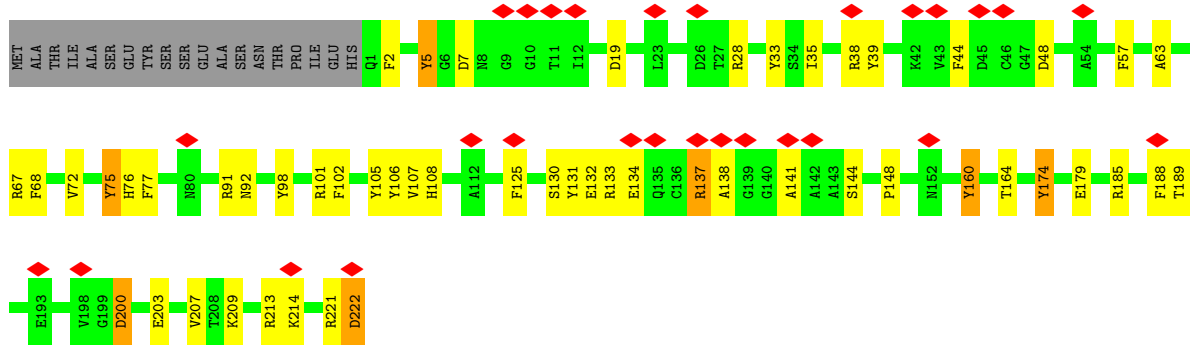

• Molecule 14: Proteasome subunit beta type-7

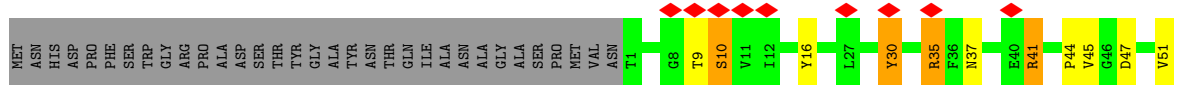

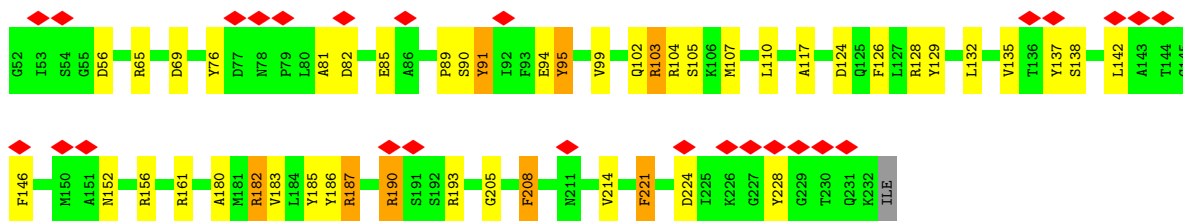

• Molecule 14: Proteasome subunit beta type-7

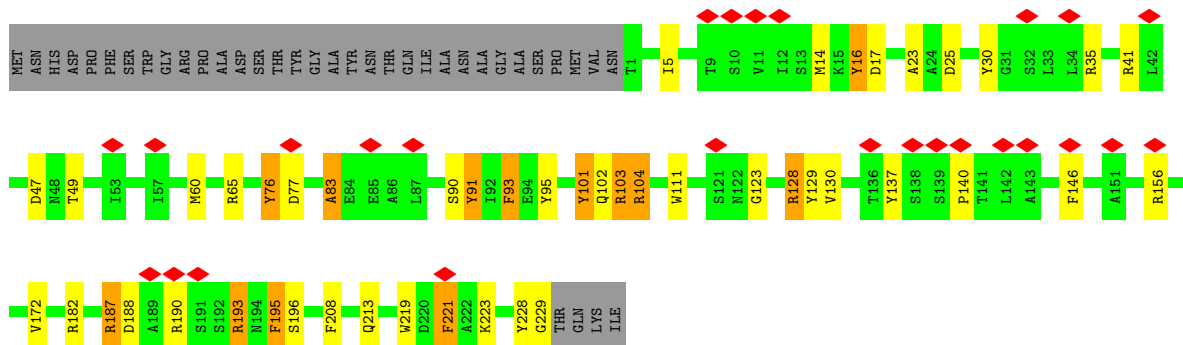

• Molecule 15: 26S protease regulatory subunit 7 homolog

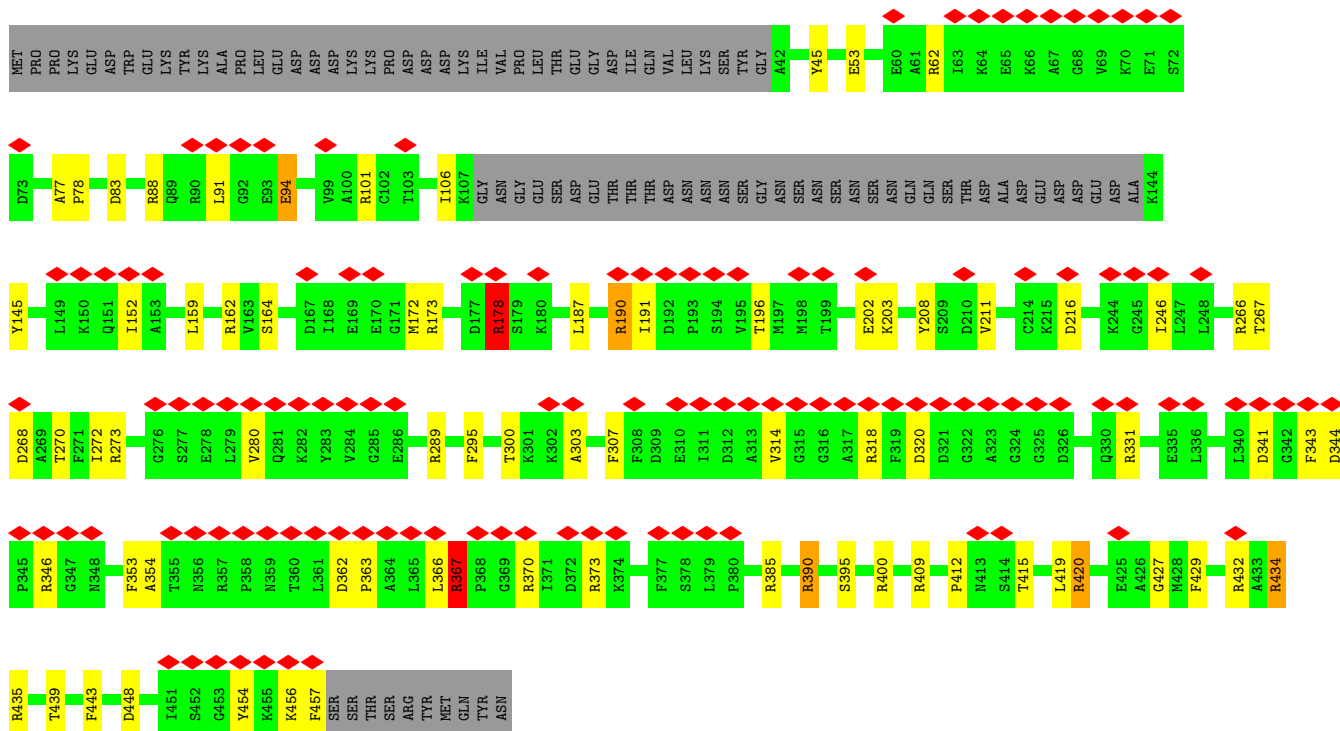

• Molecule 16: 26S protease regulatory subunit 4 homolog

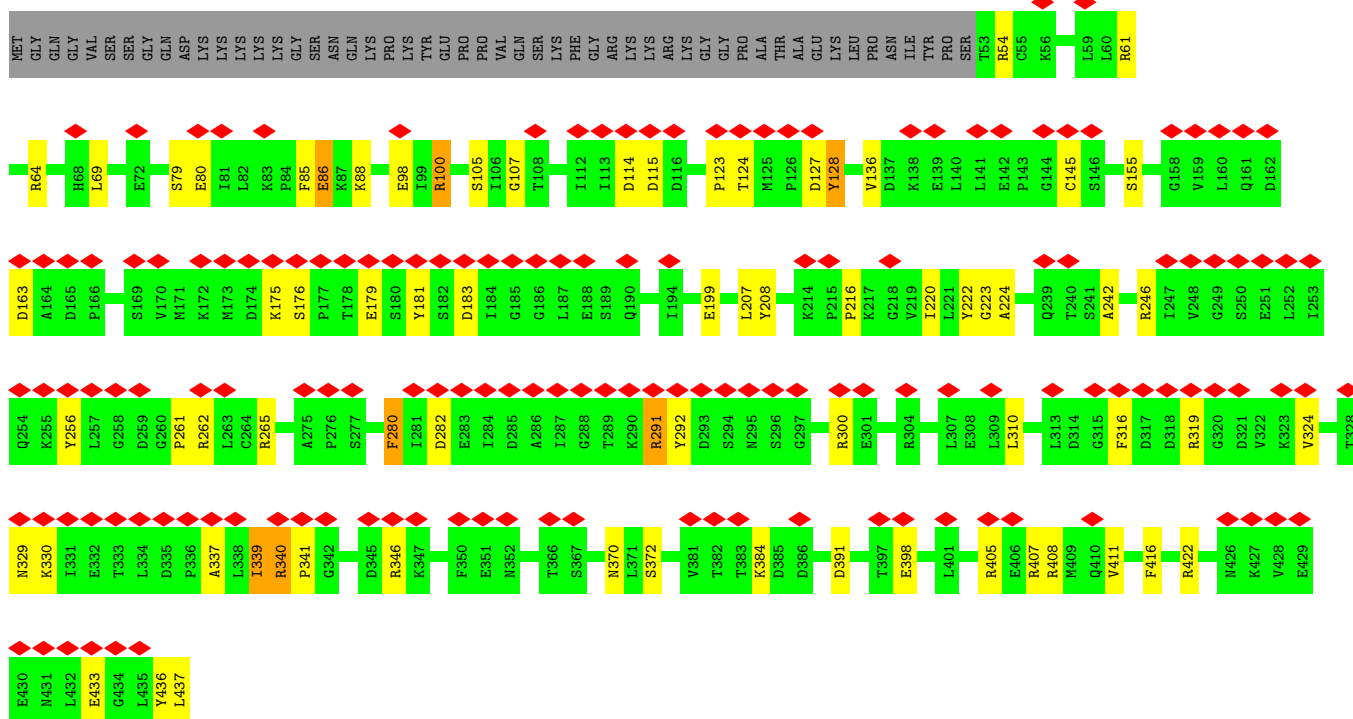

• Molecule 17: 26S protease regulatory subunit 6B homolog

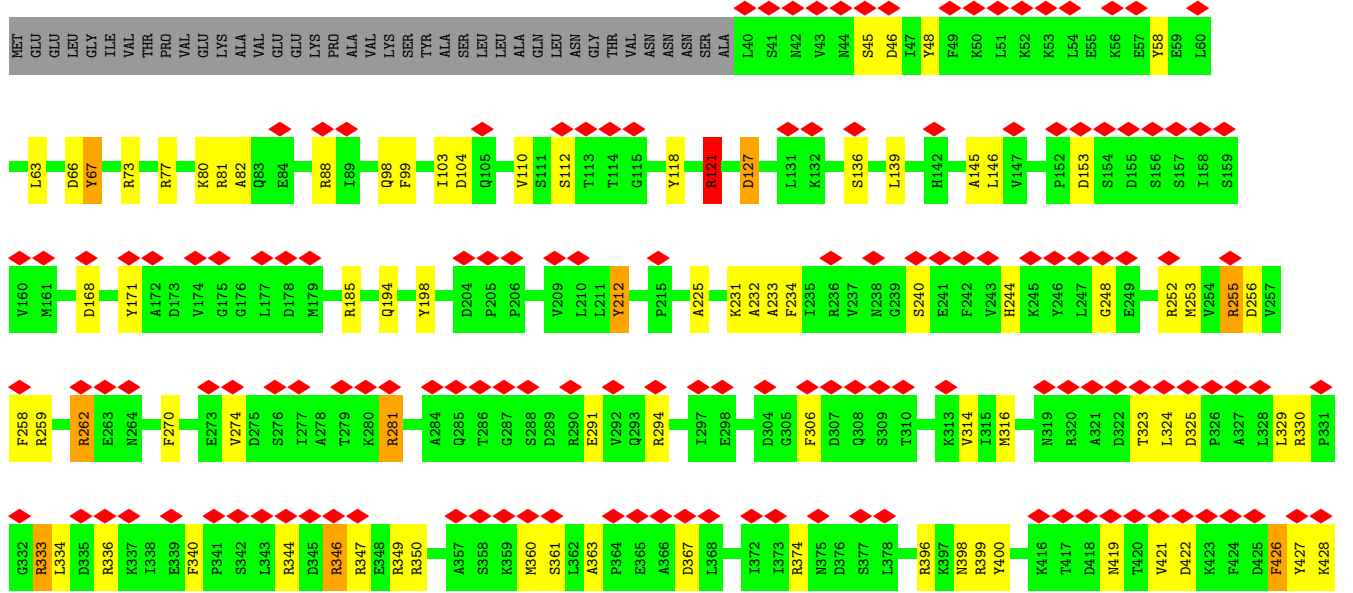

• Molecule 18: 26S protease subunit RPT4



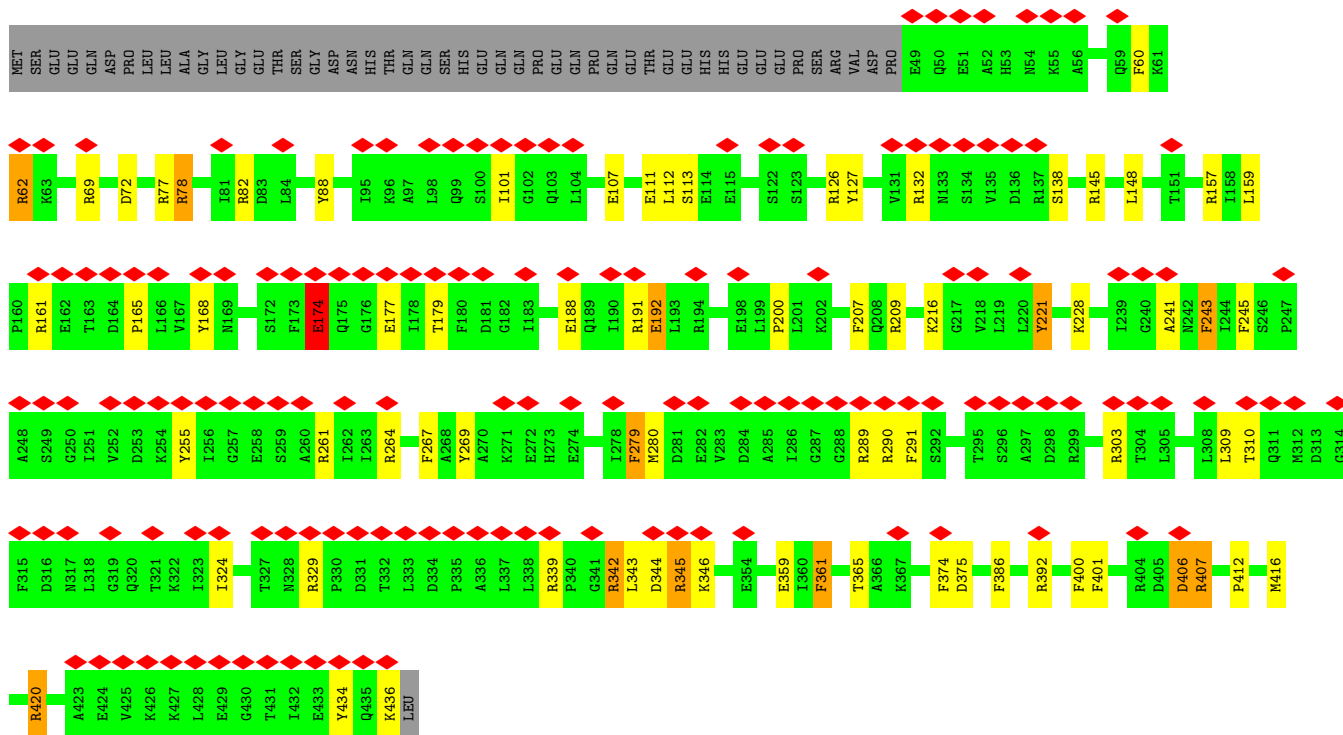

• Molecule 19: 26S protease regulatory subunit 6A

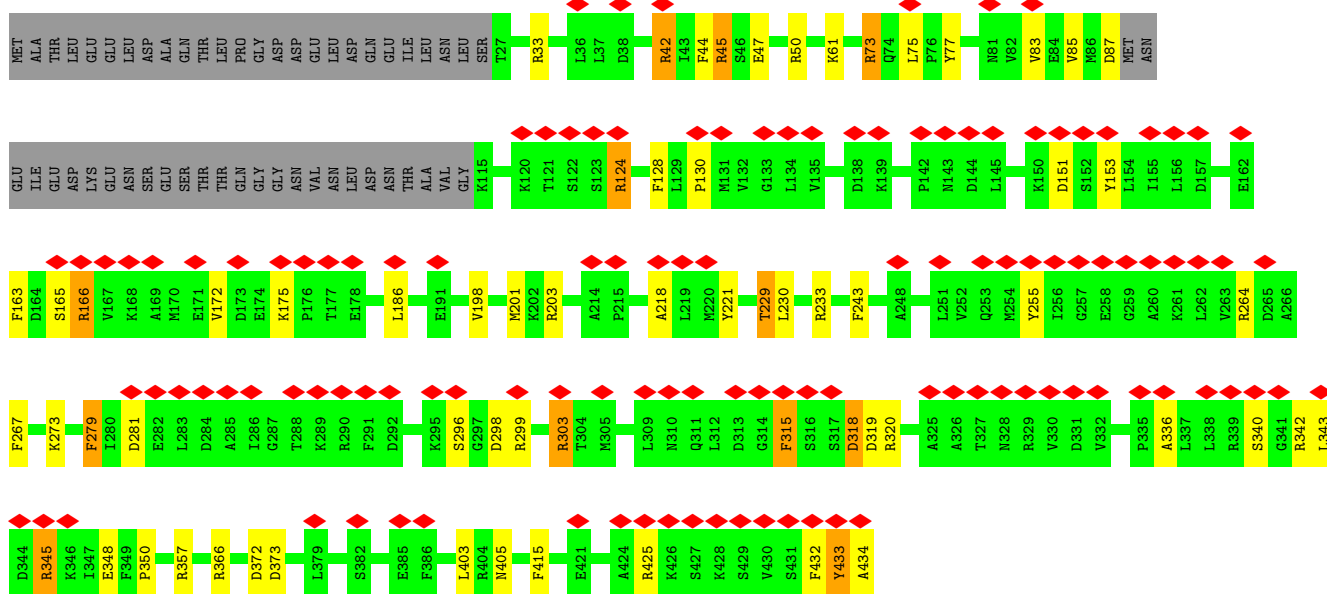
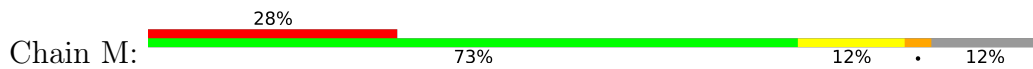

• Molecule 20: 26S protease regulatory subunit 8 homolog

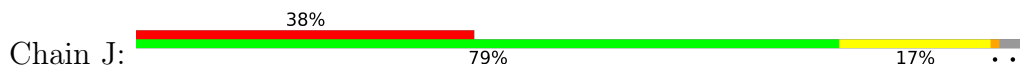

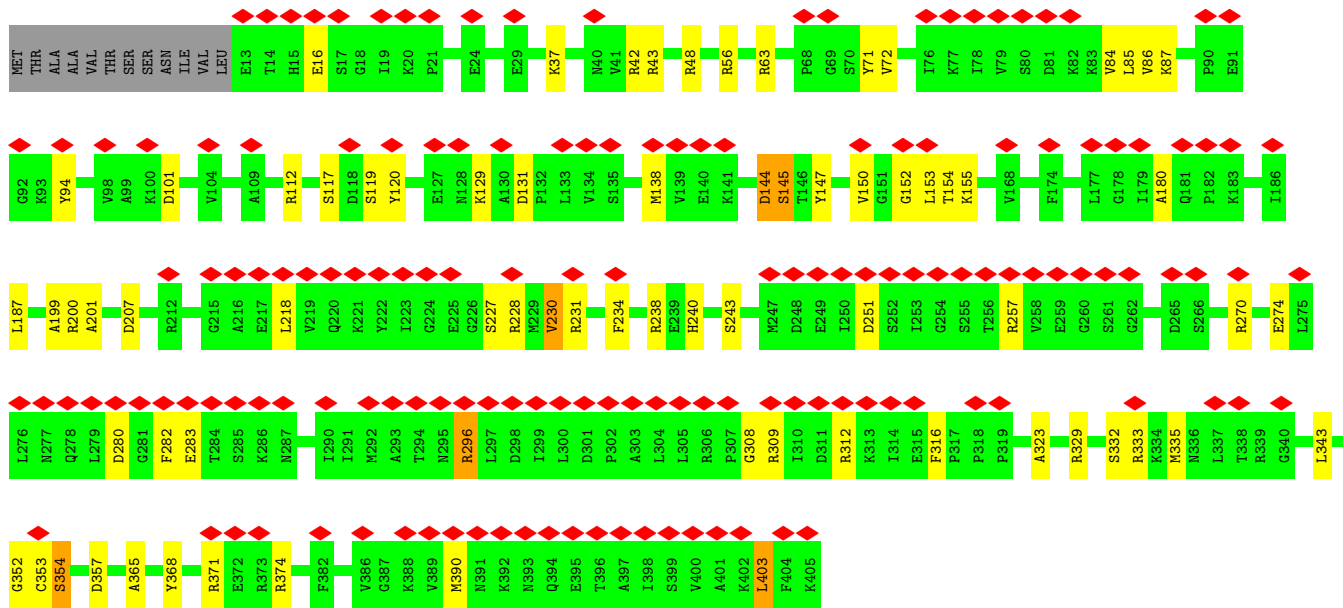

• Molecule 21: 26S proteasome regulatory subunit RPN10

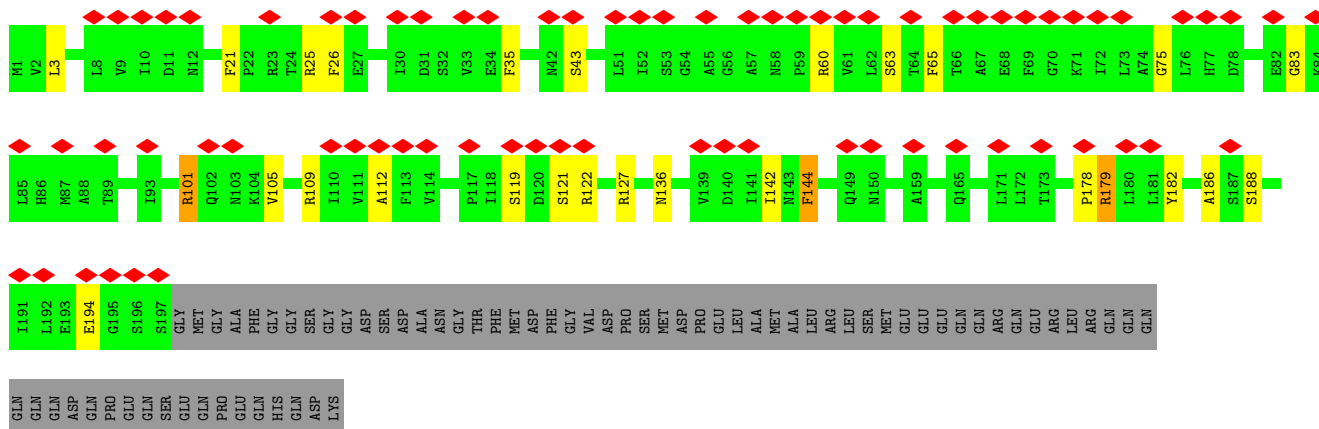

• Molecule 22: Ubiquitin carboxyl-terminal hydrolase RPN11

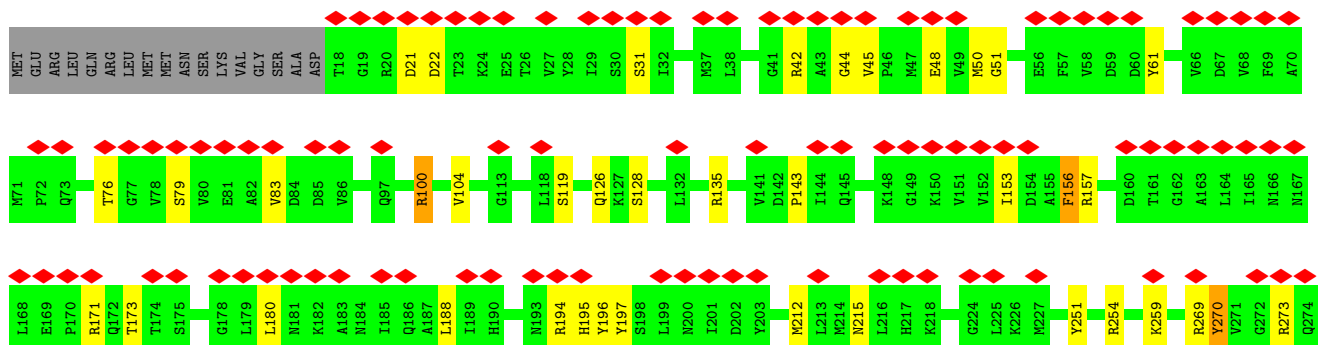
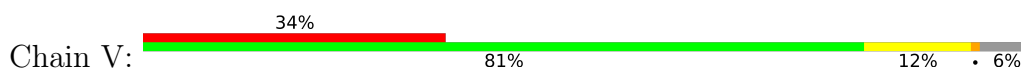





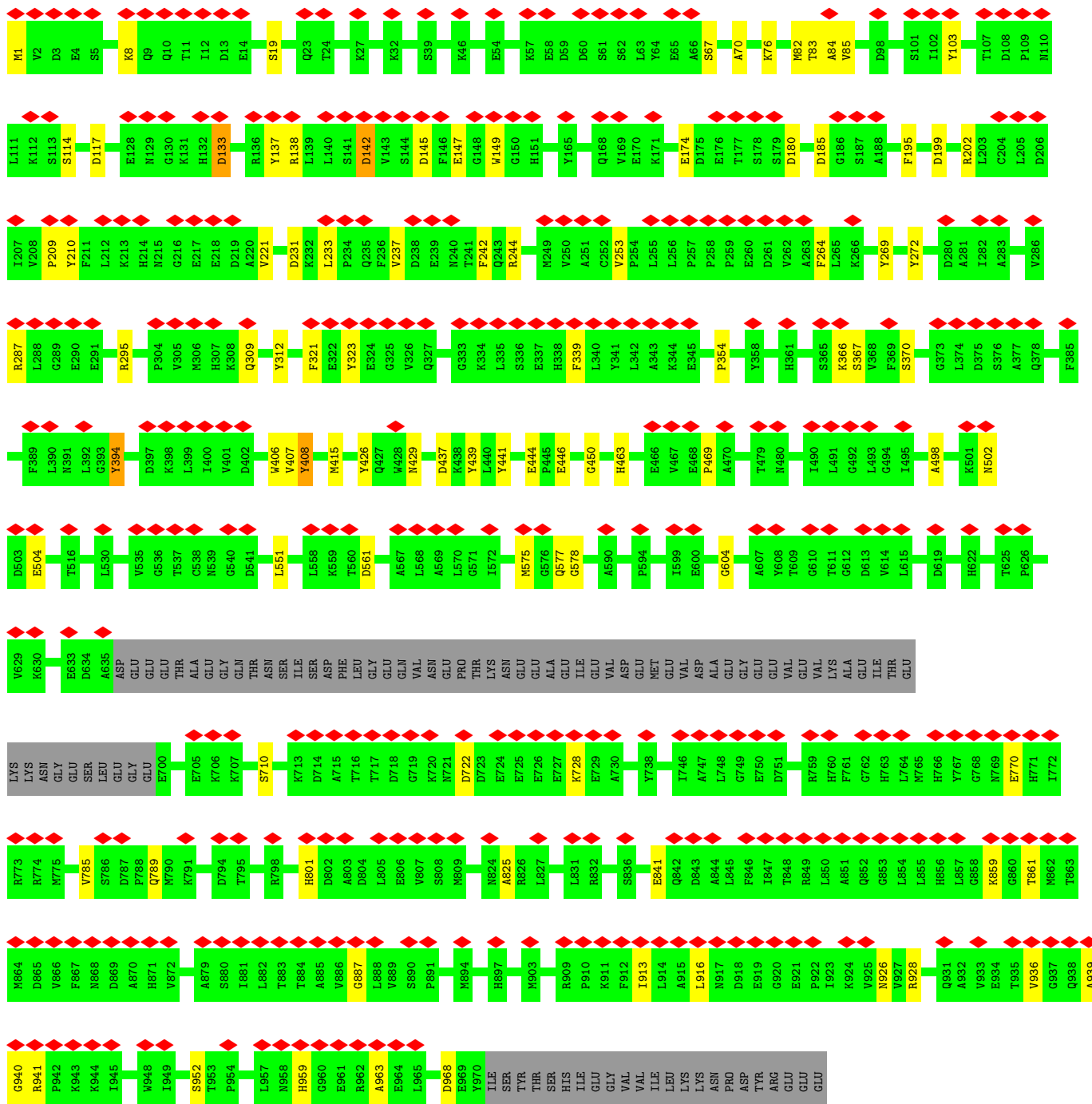
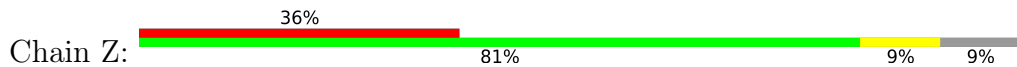

• Molecule 27: 26S proteasome regulatory subunit RPN2

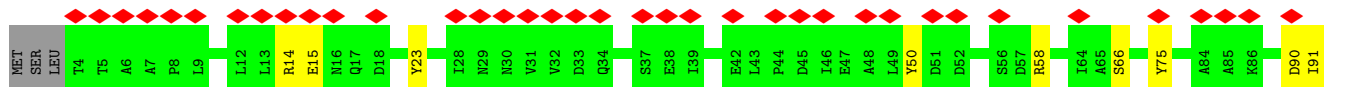
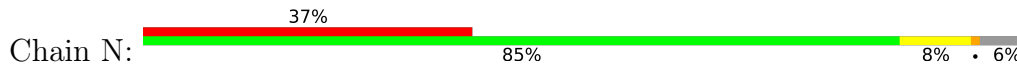

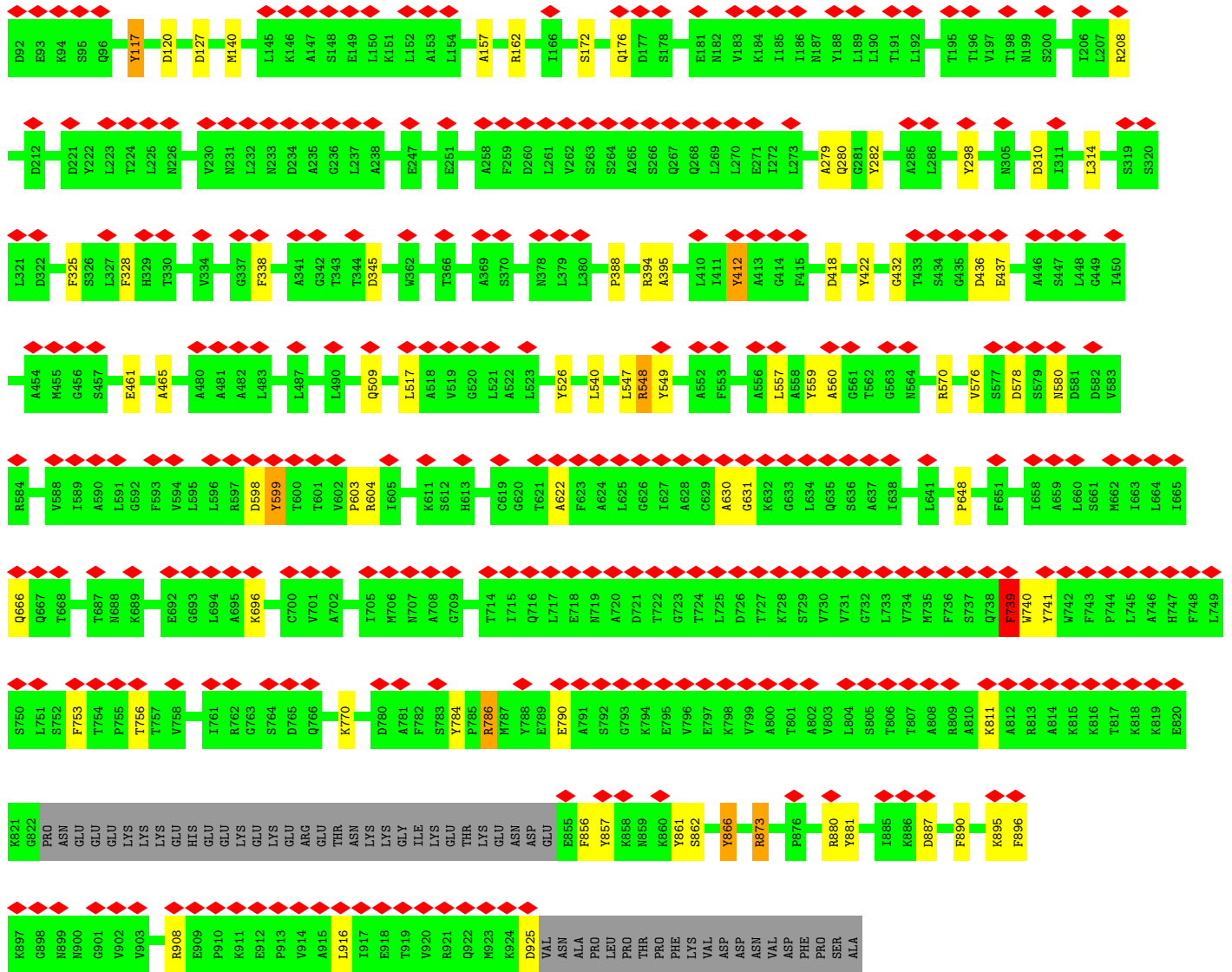

● Molecule 28: 26S proteasome regulatory subunit RPN3

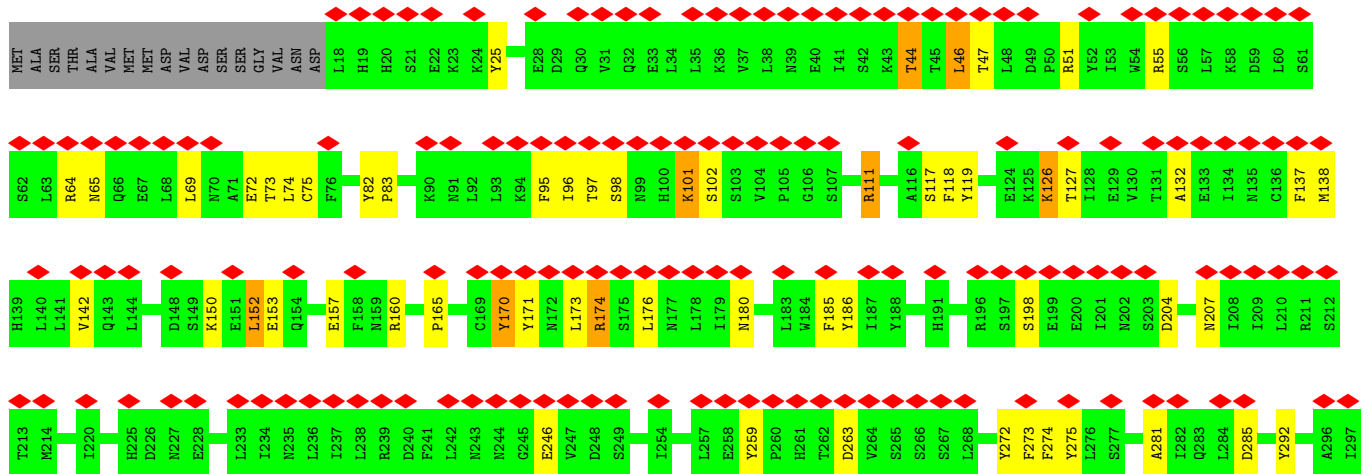
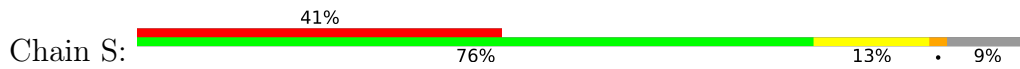

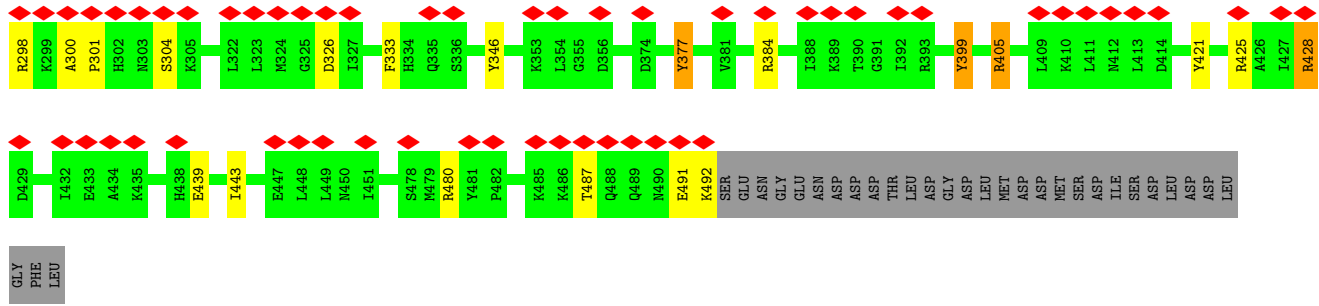

• Molecule 29: 26S proteasome regulatory subunit RPN5

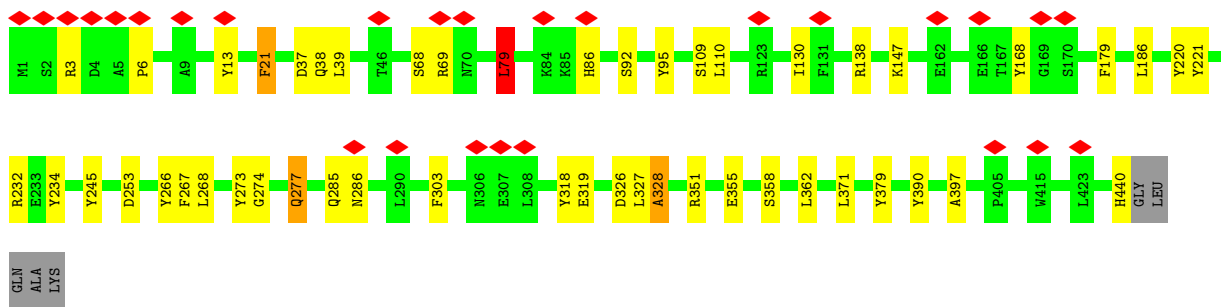
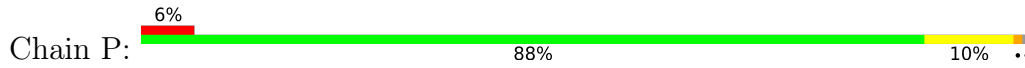

• Molecule 30: 26S proteasome regulatory subunit RPN6

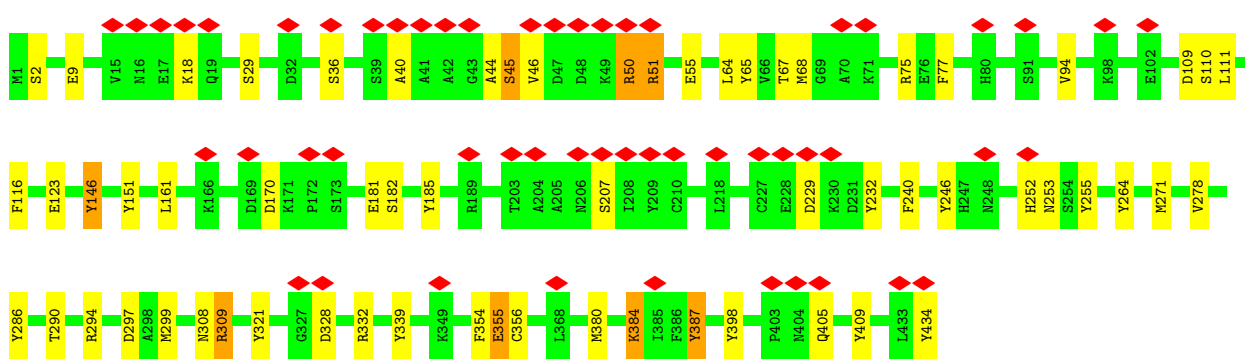
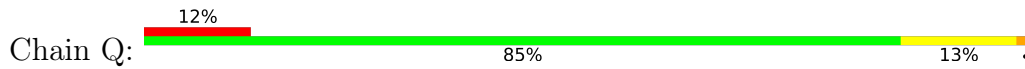

• Molecule 31: 26S proteasome regulatory subunit RPN7

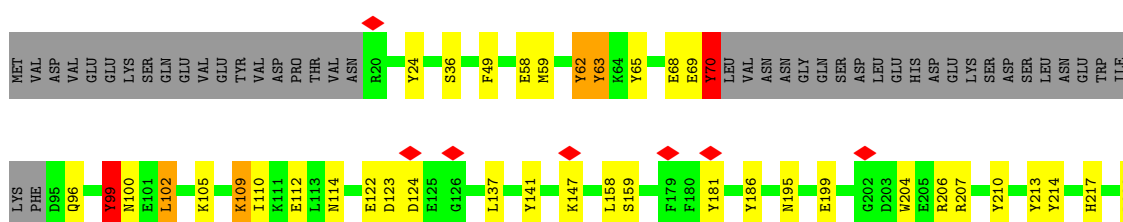
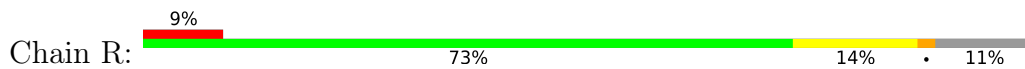

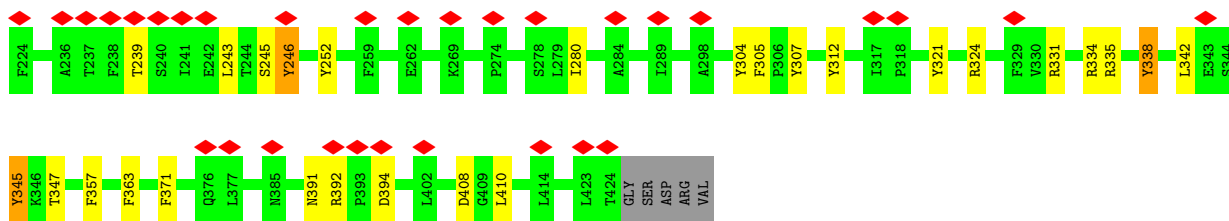

• Molecule 32: 26S proteasome regulatory subunit RPN8

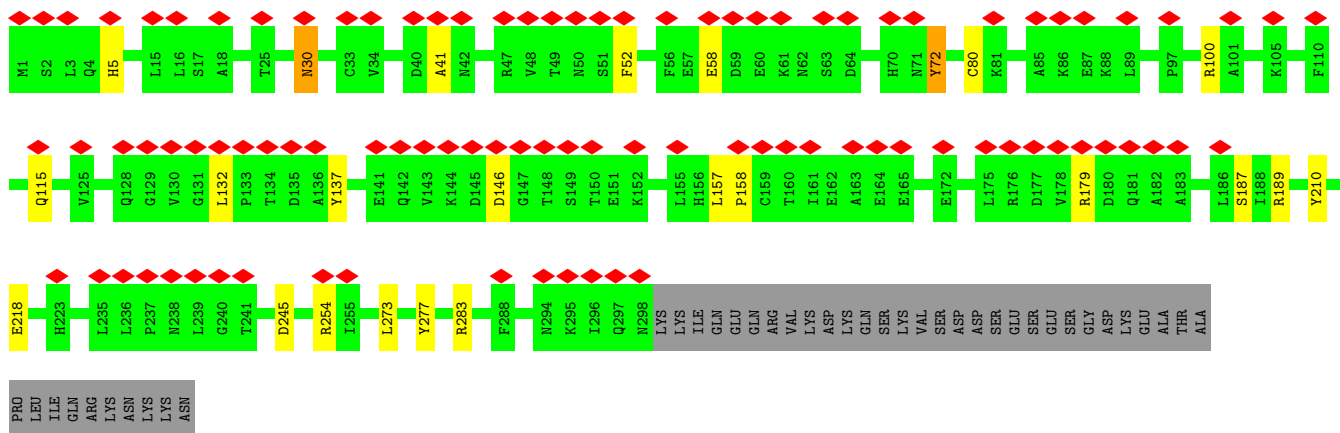
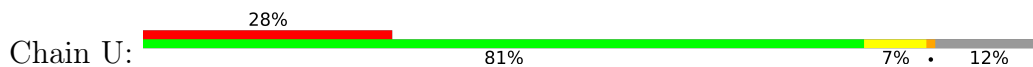

• Molecule 33: 26S proteasome regulatory subunit RPN9

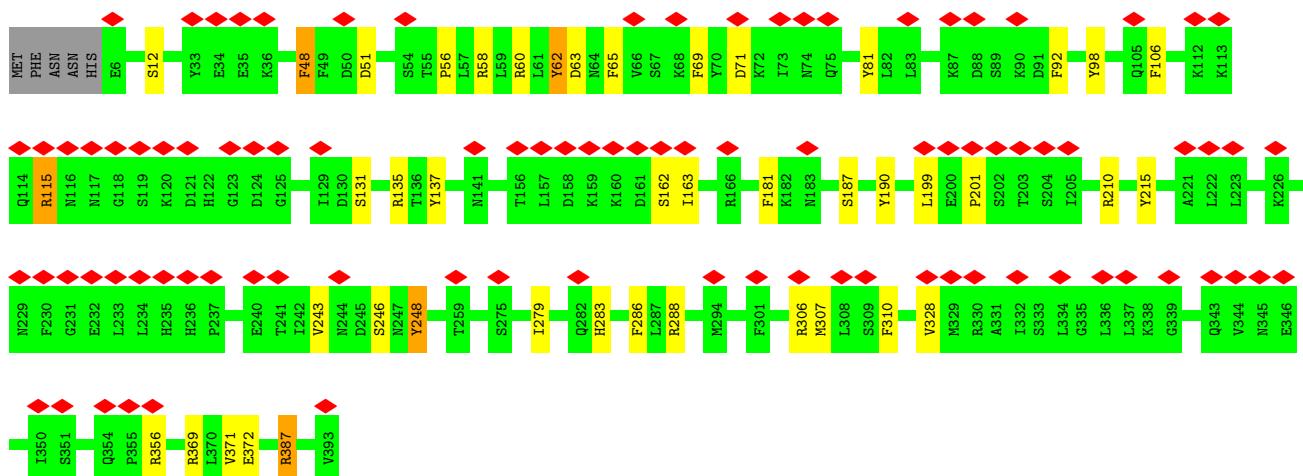
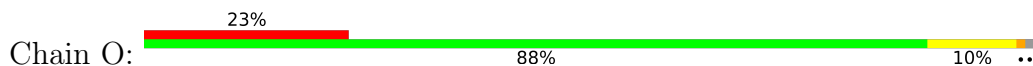

• Molecule 34: Ubiquitin carboxyl-terminal hydrolase 6

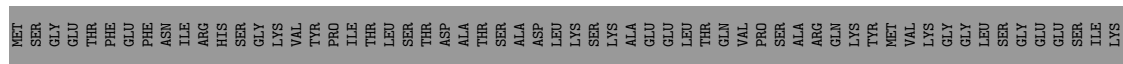
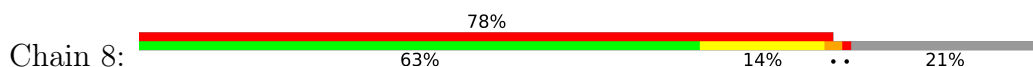

ILE	TYR	PRO	LEU	ILE	LYS	PRO	GLY	SER	THR	VAL	MET	LEU	LEU	GLY	THR	PRO	ASP	ASP	ALA	ASN	ASN	PHE	ILE	GLU	ASP	LEU	ALA	PRO	PRO	GLU	GLN	GLN	VAL	GLN	GLN	PHE	A105	Q106	L107	P108	V109	G110	F111	K112	N113	M114	G115	N116	T117	C118	Y119	L120							
M121	A122	T123	L124	Q125	A126	L127	Y128	R129	V130	N131	D132	L133	R134	D135	M136	I137	L138	M139	Y140	N141	P142	S143	Q144	G145	V146	S147	M148	S149	G150	A151	Q152	D153	E154	E155	I156	H157	K158	Q159	I160	V161	I162	E163	M164	F165	R166	C167	F168	E169	N170	L171	Q172	N173	K174	S175	F176	K177	S178	V179	L180
P181	T182	V183	L184	L185	M186	T187	L188	R189	K190	C191	Y192	P193	Q194	F195	A196	E197	R198	D199	S200	Q201	G202	G203	F204	Y205	K206	Q207	Q208	D209	A210	E211	E212	L213	F214	T215	Q216	L217	F218	H219	S220	M221	S222	I223	V224	F225	G226	D227	K228	F229	S230	E231	D232	F233	R234	I235	Q236	F237	K238	T239	T240
I241	K242	D243	T244	A245	N246	D247	N248	D249	I250	T251	V252	K253	E254	N255	E256	S257	S259	K260	L261	Q262	C263	H264	I265	S266	G267	T268	T269	N270	F271	M272	R273	N274	G275	L276	L277	E278	G279	L280	N281	E282	K283	I284	E285	K286	R287	S288	D289	L290	T291	G292	A293	N294	S295	I296	Y297	S298	V299	E300	
K301	K302	I303	S304	R305	L306	P307	K308	F309	L310	T311	V312	Q313	Y314	V315	R316	F317	F318	W319	K320	R321	S322	T323	N324	K325	K326	I329	L330	R331	K332	V333	V334	F335	P336	F337	Q338	L339	D340	V341	A342	D343	M344	L345	T346	P347	E348	Y349	A350	A351	E352	K353	V354	K355	V356	R357	D358	E359	L360	R361	
K362	V363	E364	K365	E366	K367	N368	E369	K370	E371	R372	E373	I374	K375	R376	R377	K378	F379	D380	P381	S382	S383	S384	E385	N386	V387	M388	T389	P390	R391	E392	Q393	Y394	E395	T396	Q397	V398	A399	L400	N401	E402	S403	E404	K405	D406	Q407	W408	L409	E410	E411	Y412	K413	K414	H415	F416	P417	N418	N419	L420	E421
K422	G423	E424	N425	P426	S427	C428	V429	Y430	N431	L432	T433	G434	V435	I436	T437	H438	Q439	G440	A441	N442	S443	E444	S445	G446	H447	Y448	Q449	A450	F451	I452	R453	D454	E455	L456	D457	E458	N459	K460	N461	Y462	K463	F464	N465	D466	D467	K468	V469	S470	V471	V472	E473	K474	E475	K476	T477	E478	S479	L480	A481
G482	G483	G484	E485	S486	D487	S488	A489	L490	T491	L492	M493	Y494	K495	G496	F497	G498	L499																																										

## 4 Experimental information

Property	Value	Source
EM reconstruction method	SINGLE PARTICLE	Depositor
Imposed symmetry	POINT, C1	Depositor
Number of particles used	27600	Depositor
Resolution determination method	FSC 0.143 CUT-OFF	Depositor
CTF correction method	PHASE FLIPPING AND AMPLITUDE CORRECTION	Depositor
Microscope	FEI TITAN KRIOS	Depositor
Voltage (kV)	300	Depositor
Electron dose ( $e^-/\text{\AA}^2$ )	45	Depositor
Minimum defocus (nm)	1500	Depositor
Maximum defocus (nm)	3500	Depositor
Magnification	Not provided	
Image detector	FEI FALCON II (4k x 4k)	Depositor
Maximum map value	0.117	Depositor
Minimum map value	-0.080	Depositor
Average map value	0.000	Depositor
Map value standard deviation	0.004	Depositor
Recommended contour level	0.023	Depositor
Map size (Å)	1.0, 1.0, 1.0	wwPDB
Map dimensions	416, 416, 416	wwPDB
Map angles (°)	90.0, 90.0, 90.0	wwPDB
Pixel spacing (Å)	1.3500001, 1.3500001, 1.3500001	Depositor

## 5 Model quality i

### 5.1 Standard geometry i

Bond lengths and bond angles in the following residue types are not validated in this section: ATP, ADP, MG

The Z score for a bond length (or angle) is the number of standard deviations the observed value is removed from the expected value. A bond length (or angle) with  $|Z| > 5$  is considered an outlier worth inspection. RMSZ is the root-mean-square of all Z scores of the bond lengths (or angles).

Mol	Chain	Bond lengths		Bond angles	
		RMSZ	$\# Z  > 5$	RMSZ	$\# Z  > 5$
1	A	1.77	27/1945 (1.4%)	1.95	52/2634 (2.0%)
1	a	1.78	25/1945 (1.3%)	1.93	47/2634 (1.8%)
2	B	1.74	21/1952 (1.1%)	1.87	40/2642 (1.5%)
2	b	1.73	19/1952 (1.0%)	1.92	46/2642 (1.7%)
3	C	1.73	18/1934 (0.9%)	1.96	58/2618 (2.2%)
3	c	1.73	20/1934 (1.0%)	2.04	69/2618 (2.6%)
4	D	1.82	29/1910 (1.5%)	1.88	50/2586 (1.9%)
4	d	1.76	23/1910 (1.2%)	1.94	55/2586 (2.1%)
5	E	1.77	16/1886 (0.8%)	1.87	43/2541 (1.7%)
5	e	1.72	11/1886 (0.6%)	1.95	45/2541 (1.8%)
6	F	1.75	21/1823 (1.2%)	1.95	48/2463 (1.9%)
6	f	1.77	21/1800 (1.2%)	1.95	48/2433 (2.0%)
7	G	1.73	16/1932 (0.8%)	1.91	42/2609 (1.6%)
7	g	1.76	21/1932 (1.1%)	1.93	61/2609 (2.3%)
8	1	1.77	20/1541 (1.3%)	1.97	41/2087 (2.0%)
8	h	1.73	12/1541 (0.8%)	1.93	47/2087 (2.3%)
9	2	1.65	12/1750 (0.7%)	1.84	40/2373 (1.7%)
9	i	1.72	24/1750 (1.4%)	1.86	31/2373 (1.3%)
10	3	1.80	15/1611 (0.9%)	1.92	41/2174 (1.9%)
10	j	1.78	14/1611 (0.9%)	1.98	43/2174 (2.0%)
11	4	1.80	25/1589 (1.6%)	1.96	39/2142 (1.8%)
11	k	1.73	14/1589 (0.9%)	2.03	43/2142 (2.0%)
12	5	1.80	18/1681 (1.1%)	1.89	37/2274 (1.6%)
12	l	1.79	12/1681 (0.7%)	2.03	49/2274 (2.2%)
13	6	1.82	22/1795 (1.2%)	1.88	45/2420 (1.9%)
13	m	1.76	26/1795 (1.4%)	2.00	52/2420 (2.1%)
14	7	1.75	20/1821 (1.1%)	2.01	46/2470 (1.9%)
14	n	1.82	31/1846 (1.7%)	1.98	48/2503 (1.9%)
15	H	1.64	24/3014 (0.8%)	1.75	47/4058 (1.2%)
16	I	1.60	26/3061 (0.8%)	1.73	41/4121 (1.0%)
17	K	1.63	28/3121 (0.9%)	1.79	70/4213 (1.7%)
18	L	1.63	25/3128 (0.8%)	1.79	70/4204 (1.7%)



Mol	Chain	Bond lengths		Bond angles	
		RMSZ	# Z  >5	RMSZ	# Z  >5
19	M	1.59	24/3023 (0.8%)	1.76	47/4070 (1.2%)
20	J	1.56	16/3130 (0.5%)	1.72	50/4203 (1.2%)
21	W	1.48	11/1557 (0.7%)	1.63	19/2111 (0.9%)
22	V	1.45	14/2309 (0.6%)	1.59	28/3115 (0.9%)
23	T	1.46	8/2235 (0.4%)	1.67	36/3017 (1.2%)
24	X	1.66	9/1058 (0.9%)	1.78	22/1432 (1.5%)
25	Y	1.66	2/438 (0.5%)	1.61	5/583 (0.9%)
26	Z	1.46	21/7122 (0.3%)	1.51	62/9645 (0.6%)
27	N	1.48	20/6994 (0.3%)	1.58	82/9455 (0.9%)
28	S	1.60	17/3966 (0.4%)	1.65	52/5355 (1.0%)
29	P	1.46	12/3663 (0.3%)	1.62	29/4940 (0.6%)
30	Q	1.47	12/3556 (0.3%)	1.64	49/4787 (1.0%)
31	R	1.58	13/3110 (0.4%)	1.85	74/4193 (1.8%)
32	U	1.46	4/2407 (0.2%)	1.52	27/3258 (0.8%)
33	O	1.50	13/3247 (0.4%)	1.65	38/4380 (0.9%)
34	8	1.72	29/3278 (0.9%)	2.00	90/4402 (2.0%)
All	All	1.64	881/113759 (0.8%)	1.80	2244/153611 (1.5%)

Chiral center outliers are detected by calculating the chiral volume of a chiral center and verifying if the center is modelled as a planar moiety or with the opposite hand. A planarity outlier is detected by checking planarity of atoms in a peptide group, atoms in a mainchain group or atoms of a sidechain that are expected to be planar.

Mol	Chain	#Chirality outliers	#Planarity outliers
1	A	0	5
1	a	0	7
2	B	0	6
2	b	0	5
3	C	0	10
3	c	0	10
4	D	0	6
4	d	0	8
5	E	0	11
5	e	0	4
6	F	0	7
6	f	0	7
7	G	0	4
7	g	0	5
8	l	0	4
8	h	0	8
9	2	0	6
9	i	0	8

*Continued on next page...*

*Continued from previous page...*

Mol	Chain	#Chirality outliers	#Planarity outliers
10	3	0	1
10	j	0	6
11	4	0	5
11	k	0	7
12	5	0	4
12	l	0	12
13	6	0	8
13	m	0	9
14	7	0	10
14	n	0	11
15	H	0	6
16	I	0	7
17	K	0	13
18	L	0	12
19	M	0	13
20	J	0	6
21	W	0	4
22	V	0	4
23	T	0	9
24	X	0	4
26	Z	0	3
27	N	0	10
28	S	0	10
29	P	0	10
30	Q	0	6
31	R	0	16
32	U	0	2
33	O	0	7
34	8	0	11
All	All	0	347

The worst 5 of 881 bond length outliers are listed below:

Mol	Chain	Res	Type	Atoms	Z	Observed(Å)	Ideal(Å)
28	S	126	LYS	CA-CB	-39.49	0.67	1.53
27	N	861	TYR	CA-CB	15.62	1.88	1.53
14	7	229	GLY	C-O	-14.51	1.00	1.23
12	5	212	GLY	C-O	-14.49	1.00	1.23
13	6	222	ASP	C-OXT	-12.08	1.00	1.23

The worst 5 of 2244 bond angle outliers are listed below:

Mol	Chain	Res	Type	Atoms	Z	Observed(°)	Ideal(°)
29	P	86	HIS	CB-CA-C	-25.66	59.08	110.40
29	P	86	HIS	N-CA-CB	21.88	149.97	110.60
31	R	70	TYR	CB-CG-CD1	20.53	133.32	121.00
31	R	70	TYR	CB-CG-CD2	-20.08	108.95	121.00
11	k	96	ARG	NE-CZ-NH1	18.02	129.31	120.30

There are no chirality outliers.

5 of 347 planarity outliers are listed below:

Mol	Chain	Res	Type	Group
1	a	15	ARG	Sidechain
1	a	3	TYR	Sidechain
1	a	62	TYR	Sidechain
1	a	82	ARG	Sidechain
1	a	96	ARG	Sidechain

## 5.2 Too-close contacts [i](#)

Due to software issues we are unable to calculate clashes - this section is therefore empty.

## 5.3 Torsion angles [i](#)

### 5.3.1 Protein backbone [i](#)

In the following table, the Percentiles column shows the percent Ramachandran outliers of the chain as a percentile score with respect to all PDB entries followed by that with respect to all EM entries.

The Analysed column shows the number of residues for which the backbone conformation was analysed, and the total number of residues.

Mol	Chain	Analysed	Favoured	Allowed	Outliers	Percentiles	
1	A	239/252 (95%)	227 (95%)	11 (5%)	1 (0%)	34	72
1	a	239/252 (95%)	231 (97%)	8 (3%)	0	100	100
2	B	248/250 (99%)	236 (95%)	11 (4%)	1 (0%)	34	72
2	b	248/250 (99%)	234 (94%)	11 (4%)	3 (1%)	13	50
3	C	242/258 (94%)	228 (94%)	11 (4%)	3 (1%)	13	50
3	c	242/258 (94%)	227 (94%)	12 (5%)	3 (1%)	13	50
4	D	238/254 (94%)	222 (93%)	12 (5%)	4 (2%)	9	42

*Continued on next page...*

*Continued from previous page...*

Mol	Chain	Analysed	Favoured	Allowed	Outliers	Percentiles	
4	d	238/254 (94%)	219 (92%)	16 (7%)	3 (1%)	12	48
5	E	240/260 (92%)	227 (95%)	11 (5%)	2 (1%)	19	60
5	e	240/260 (92%)	228 (95%)	10 (4%)	2 (1%)	19	60
6	F	231/234 (99%)	220 (95%)	9 (4%)	2 (1%)	17	57
6	f	229/234 (98%)	221 (96%)	8 (4%)	0	100	100
7	G	241/288 (84%)	228 (95%)	12 (5%)	1 (0%)	34	72
7	g	241/288 (84%)	230 (95%)	10 (4%)	1 (0%)	34	72
8	l	194/215 (90%)	184 (95%)	8 (4%)	2 (1%)	15	55
8	h	194/215 (90%)	189 (97%)	5 (3%)	0	100	100
9	2	224/261 (86%)	213 (95%)	9 (4%)	2 (1%)	17	57
9	i	224/261 (86%)	214 (96%)	10 (4%)	0	100	100
10	3	202/205 (98%)	190 (94%)	10 (5%)	2 (1%)	15	55
10	j	202/205 (98%)	187 (93%)	12 (6%)	3 (2%)	10	46
11	4	193/198 (98%)	187 (97%)	6 (3%)	0	100	100
11	k	193/198 (98%)	188 (97%)	4 (2%)	1 (0%)	29	69
12	5	210/287 (73%)	201 (96%)	9 (4%)	0	100	100
12	l	210/287 (73%)	202 (96%)	7 (3%)	1 (0%)	29	69
13	6	220/241 (91%)	205 (93%)	13 (6%)	2 (1%)	17	57
13	m	220/241 (91%)	203 (92%)	17 (8%)	0	100	100
14	7	227/266 (85%)	209 (92%)	16 (7%)	2 (1%)	17	57
14	n	230/266 (86%)	214 (93%)	14 (6%)	2 (1%)	17	57
15	H	376/467 (80%)	340 (90%)	23 (6%)	13 (4%)	3	25
16	I	383/437 (88%)	346 (90%)	27 (7%)	10 (3%)	5	31
17	K	387/428 (90%)	351 (91%)	24 (6%)	12 (3%)	4	27
18	L	386/437 (88%)	353 (92%)	26 (7%)	7 (2%)	8	40
19	M	377/434 (87%)	350 (93%)	19 (5%)	8 (2%)	7	36
20	J	391/405 (96%)	360 (92%)	21 (5%)	10 (3%)	5	31
21	W	195/268 (73%)	180 (92%)	11 (6%)	4 (2%)	7	36
22	V	287/306 (94%)	263 (92%)	20 (7%)	4 (1%)	11	46
23	T	264/274 (96%)	240 (91%)	19 (7%)	5 (2%)	8	38
24	X	125/156 (80%)	101 (81%)	15 (12%)	9 (7%)	1	14

*Continued on next page...*

Continued from previous page...

Mol	Chain	Analysed	Favoured	Allowed	Outliers	Percentiles	
25	Y	47/89 (53%)	44 (94%)	1 (2%)	2 (4%)	2	22
26	Z	902/993 (91%)	824 (91%)	52 (6%)	26 (3%)	4	29
27	N	886/945 (94%)	850 (96%)	25 (3%)	11 (1%)	13	50
28	S	473/523 (90%)	435 (92%)	18 (4%)	20 (4%)	3	22
29	P	438/445 (98%)	417 (95%)	13 (3%)	8 (2%)	8	40
30	Q	432/434 (100%)	387 (90%)	28 (6%)	17 (4%)	3	23
31	R	377/429 (88%)	355 (94%)	18 (5%)	4 (1%)	14	52
32	U	296/338 (88%)	284 (96%)	9 (3%)	3 (1%)	15	55
33	O	386/393 (98%)	368 (95%)	16 (4%)	2 (0%)	29	69
34	8	393/499 (79%)	366 (93%)	21 (5%)	6 (2%)	10	46
All	All	14100/15638 (90%)	13178 (94%)	698 (5%)	224 (2%)	13	44

5 of 224 Ramachandran outliers are listed below:

Mol	Chain	Res	Type
5	e	129	PRO
10	j	182	TRP
5	E	128	ARG
5	E	129	PRO
6	F	162	ALA

### 5.3.2 Protein sidechains [i](#)

In the following table, the Percentiles column shows the percent sidechain outliers of the chain as a percentile score with respect to all PDB entries followed by that with respect to all EM entries.

The Analysed column shows the number of residues for which the sidechain conformation was analysed, and the total number of residues.

Mol	Chain	Analysed	Rotameric	Outliers	Percentiles	
1	A	206/210 (98%)	199 (97%)	7 (3%)	37	60
1	a	206/210 (98%)	192 (93%)	14 (7%)	16	41
2	B	209/209 (100%)	205 (98%)	4 (2%)	57	75
2	b	209/209 (100%)	199 (95%)	10 (5%)	25	51
3	C	203/216 (94%)	195 (96%)	8 (4%)	32	56
3	c	203/216 (94%)	192 (95%)	11 (5%)	22	47

Continued on next page...

*Continued from previous page...*

Mol	Chain	Analysed	Rotameric	Outliers	Percentiles	
4	D	212/226 (94%)	204 (96%)	8 (4%)	33	57
4	d	212/226 (94%)	205 (97%)	7 (3%)	38	61
5	E	198/215 (92%)	191 (96%)	7 (4%)	36	59
5	e	198/215 (92%)	188 (95%)	10 (5%)	24	48
6	F	192/193 (100%)	187 (97%)	5 (3%)	46	66
6	f	190/193 (98%)	183 (96%)	7 (4%)	34	58
7	G	201/239 (84%)	195 (97%)	6 (3%)	41	63
7	g	201/239 (84%)	199 (99%)	2 (1%)	76	86
8	1	162/178 (91%)	161 (99%)	1 (1%)	86	92
8	h	162/178 (91%)	160 (99%)	2 (1%)	71	83
9	2	185/214 (86%)	185 (100%)	0	100	100
9	i	185/214 (86%)	181 (98%)	4 (2%)	52	71
10	3	172/173 (99%)	167 (97%)	5 (3%)	42	64
10	j	172/173 (99%)	168 (98%)	4 (2%)	50	70
11	4	173/175 (99%)	167 (96%)	6 (4%)	36	59
11	k	173/175 (99%)	168 (97%)	5 (3%)	42	64
12	5	169/235 (72%)	161 (95%)	8 (5%)	26	51
12	l	169/235 (72%)	164 (97%)	5 (3%)	41	63
13	6	185/201 (92%)	179 (97%)	6 (3%)	39	61
13	m	185/201 (92%)	181 (98%)	4 (2%)	52	71
14	7	195/224 (87%)	186 (95%)	9 (5%)	27	52
14	n	198/224 (88%)	191 (96%)	7 (4%)	36	59
15	H	320/399 (80%)	307 (96%)	13 (4%)	30	55
16	I	342/385 (89%)	326 (95%)	16 (5%)	26	51
17	K	342/374 (91%)	336 (98%)	6 (2%)	59	77
18	L	332/377 (88%)	321 (97%)	11 (3%)	38	61
19	M	329/375 (88%)	322 (98%)	7 (2%)	53	72
20	J	342/352 (97%)	328 (96%)	14 (4%)	30	55
21	W	171/230 (74%)	170 (99%)	1 (1%)	86	92
22	V	253/268 (94%)	251 (99%)	2 (1%)	81	89
23	T	249/256 (97%)	244 (98%)	5 (2%)	55	74

*Continued on next page...*

Continued from previous page...

Mol	Chain	Analysed	Rotameric	Outliers	Percentiles	
24	X	116/144 (81%)	110 (95%)	6 (5%)	23	48
25	Y	50/81 (62%)	49 (98%)	1 (2%)	55	74
26	Z	773/850 (91%)	766 (99%)	7 (1%)	78	87
27	N	745/797 (94%)	740 (99%)	5 (1%)	84	90
28	S	447/489 (91%)	439 (98%)	8 (2%)	59	77
29	P	412/415 (99%)	408 (99%)	4 (1%)	76	86
30	Q	391/391 (100%)	385 (98%)	6 (2%)	65	80
31	R	333/379 (88%)	327 (98%)	6 (2%)	59	77
32	U	271/308 (88%)	270 (100%)	1 (0%)	91	94
33	O	363/368 (99%)	360 (99%)	3 (1%)	81	89
34	8	359/449 (80%)	353 (98%)	6 (2%)	60	78
All	All	12265/13503 (91%)	11965 (98%)	300 (2%)	51	69

5 of 300 residues with a non-rotameric sidechain are listed below:

Mol	Chain	Res	Type
20	J	230	VAL
31	R	109	LYS
20	J	403	LEU
26	Z	577	GLN
1	A	221	LYS

Sometimes sidechains can be flipped to improve hydrogen bonding and reduce clashes. 5 of 102 such sidechains are listed below:

Mol	Chain	Res	Type
17	K	72	GLN
21	W	106	GLN
34	8	415	HIS
17	K	142	HIS
19	M	189	GLN

### 5.3.3 RNA [i](#)

There are no RNA molecules in this entry.

## 5.4 Non-standard residues in protein, DNA, RNA chains [i](#)

There are no non-standard protein/DNA/RNA residues in this entry.

## 5.5 Carbohydrates [i](#)

There are no monosaccharides in this entry.

## 5.6 Ligand geometry [i](#)

Of 12 ligands modelled in this entry, 6 are monoatomic - leaving 6 for Mogul analysis.

In the following table, the Counts columns list the number of bonds (or angles) for which Mogul statistics could be retrieved, the number of bonds (or angles) that are observed in the model and the number of bonds (or angles) that are defined in the Chemical Component Dictionary. The Link column lists molecule types, if any, to which the group is linked. The Z score for a bond length (or angle) is the number of standard deviations the observed value is removed from the expected value. A bond length (or angle) with  $|Z| > 2$  is considered an outlier worth inspection. RMSZ is the root-mean-square of all Z scores of the bond lengths (or angles).

Mol	Type	Chain	Res	Link	Bond lengths			Bond angles		
					Counts	RMSZ	# Z  > 2	Counts	RMSZ	# Z  > 2
35	ATP	J	501	36	26,33,33	1.26	3 (11%)	31,52,52	1.88	4 (12%)
35	ATP	M	501	36	26,33,33	1.24	2 (7%)	31,52,52	1.82	6 (19%)
37	ADP	K	501	36	24,29,29	1.28	3 (12%)	29,45,45	2.34	7 (24%)
35	ATP	I	501	36	26,33,33	1.60	4 (15%)	31,52,52	2.37	7 (22%)
37	ADP	L	501	36	24,29,29	1.39	2 (8%)	29,45,45	1.74	5 (17%)
35	ATP	H	501	36	26,33,33	1.52	6 (23%)	31,52,52	1.83	5 (16%)

In the following table, the Chirals column lists the number of chiral outliers, the number of chiral centers analysed, the number of these observed in the model and the number defined in the Chemical Component Dictionary. Similar counts are reported in the Torsion and Rings columns. '-' means no outliers of that kind were identified.

Mol	Type	Chain	Res	Link	Chirals	Torsions	Rings
35	ATP	J	501	36	-	6/18/38/38	0/3/3/3
35	ATP	M	501	36	-	5/18/38/38	0/3/3/3
37	ADP	K	501	36	-	3/12/32/32	0/3/3/3
35	ATP	I	501	36	-	3/18/38/38	0/3/3/3
37	ADP	L	501	36	-	3/12/32/32	0/3/3/3
35	ATP	H	501	36	-	6/18/38/38	0/3/3/3



The worst 5 of 20 bond length outliers are listed below:

Mol	Chain	Res	Type	Atoms	Z	Observed(Å)	Ideal(Å)
35	M	501	ATP	C8-N7	-4.25	1.27	1.34
35	I	501	ATP	C8-N7	-3.56	1.28	1.34
35	I	501	ATP	O4'-C1'	3.44	1.45	1.41
37	L	501	ADP	C8-N7	-3.12	1.29	1.34
35	J	501	ATP	C8-N7	-3.08	1.29	1.34

The worst 5 of 34 bond angle outliers are listed below:

Mol	Chain	Res	Type	Atoms	Z	Observed(°)	Ideal(°)
37	K	501	ADP	PA-O3A-PB	9.57	165.66	132.83
35	I	501	ATP	PB-O3B-PG	7.73	159.35	132.83
35	H	501	ATP	PB-O3B-PG	6.70	155.82	132.83
35	J	501	ATP	PB-O3B-PG	6.66	155.66	132.83
35	I	501	ATP	PA-O3A-PB	6.64	155.61	132.83

There are no chirality outliers.

5 of 26 torsion outliers are listed below:

Mol	Chain	Res	Type	Atoms
35	H	501	ATP	PB-O3B-PG-O2G
35	I	501	ATP	C5'-O5'-PA-O1A
35	M	501	ATP	PB-O3B-PG-O2G
35	M	501	ATP	PB-O3B-PG-O3G
35	J	501	ATP	C5'-O5'-PA-O3A

There are no ring outliers.

No monomer is involved in short contacts.

The following is a two-dimensional graphical depiction of Mogul quality analysis of bond lengths, bond angles, torsion angles, and ring geometry for all instances of the Ligand of Interest. In addition, ligands with molecular weight > 250 and outliers as shown on the validation Tables will also be included. For torsion angles, if less than 5% of the Mogul distribution of torsion angles is within 10 degrees of the torsion angle in question, then that torsion angle is considered an outlier. Any bond that is central to one or more torsion angles identified as an outlier by Mogul will be highlighted in the graph. For rings, the root-mean-square deviation (RMSD) between the ring in question and similar rings identified by Mogul is calculated over all ring torsion angles. If the average RMSD is greater than 60 degrees and the minimal RMSD between the ring in question and any Mogul-identified rings is also greater than 60 degrees, then that ring is considered an outlier. The outliers are highlighted in purple. The color gray indicates Mogul did not find sufficient equivalents in the CSD to analyse the geometry.

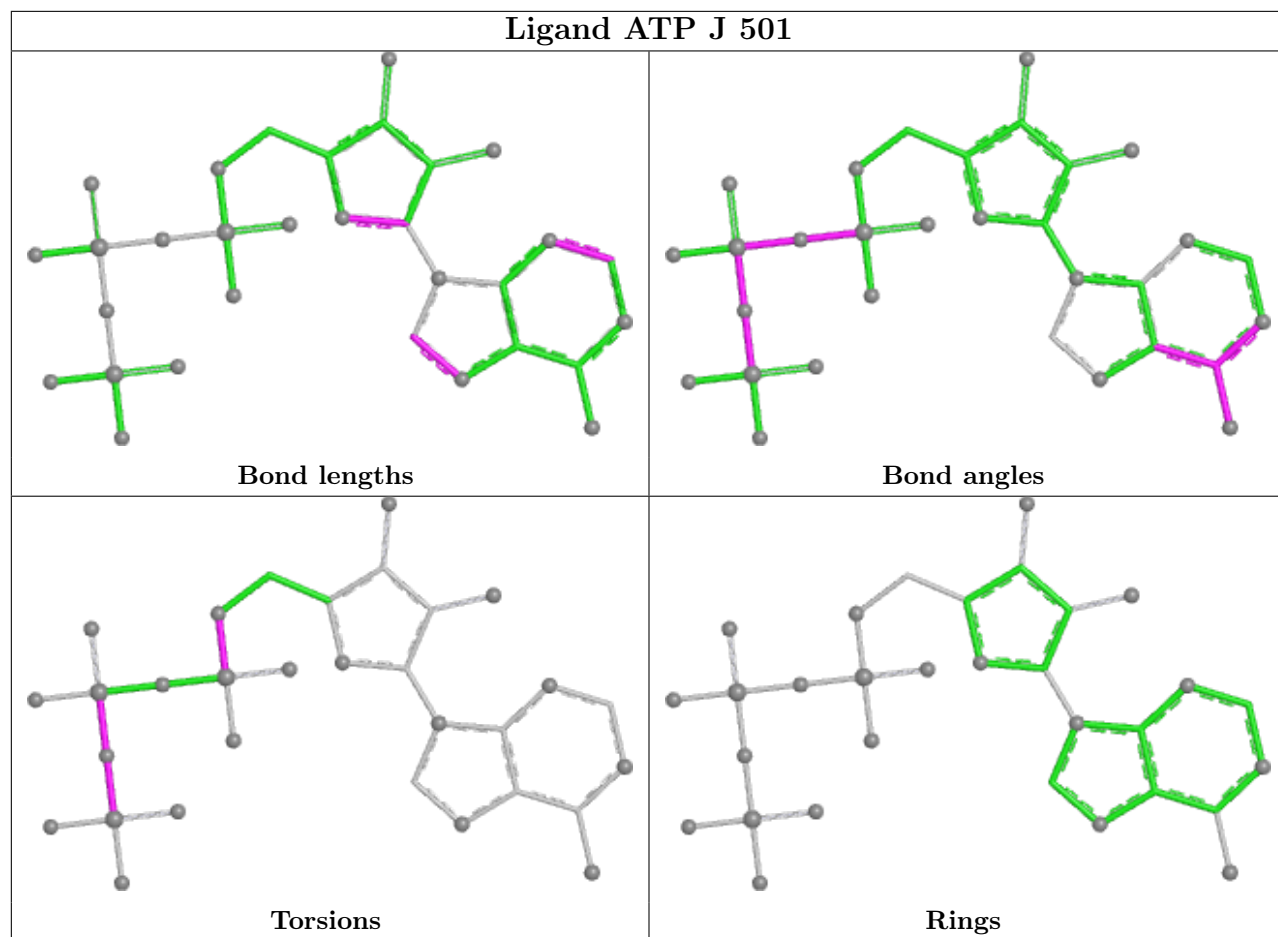

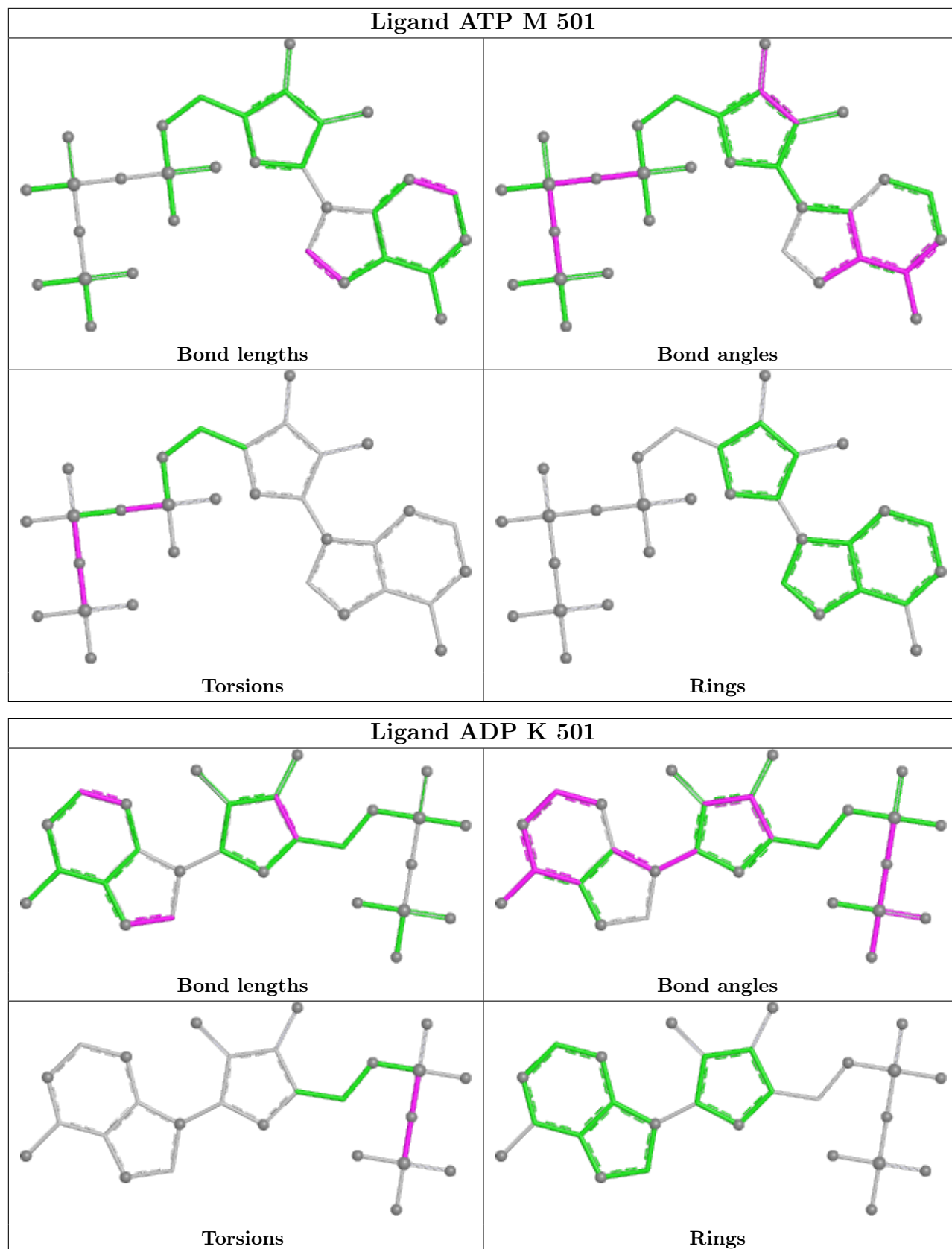

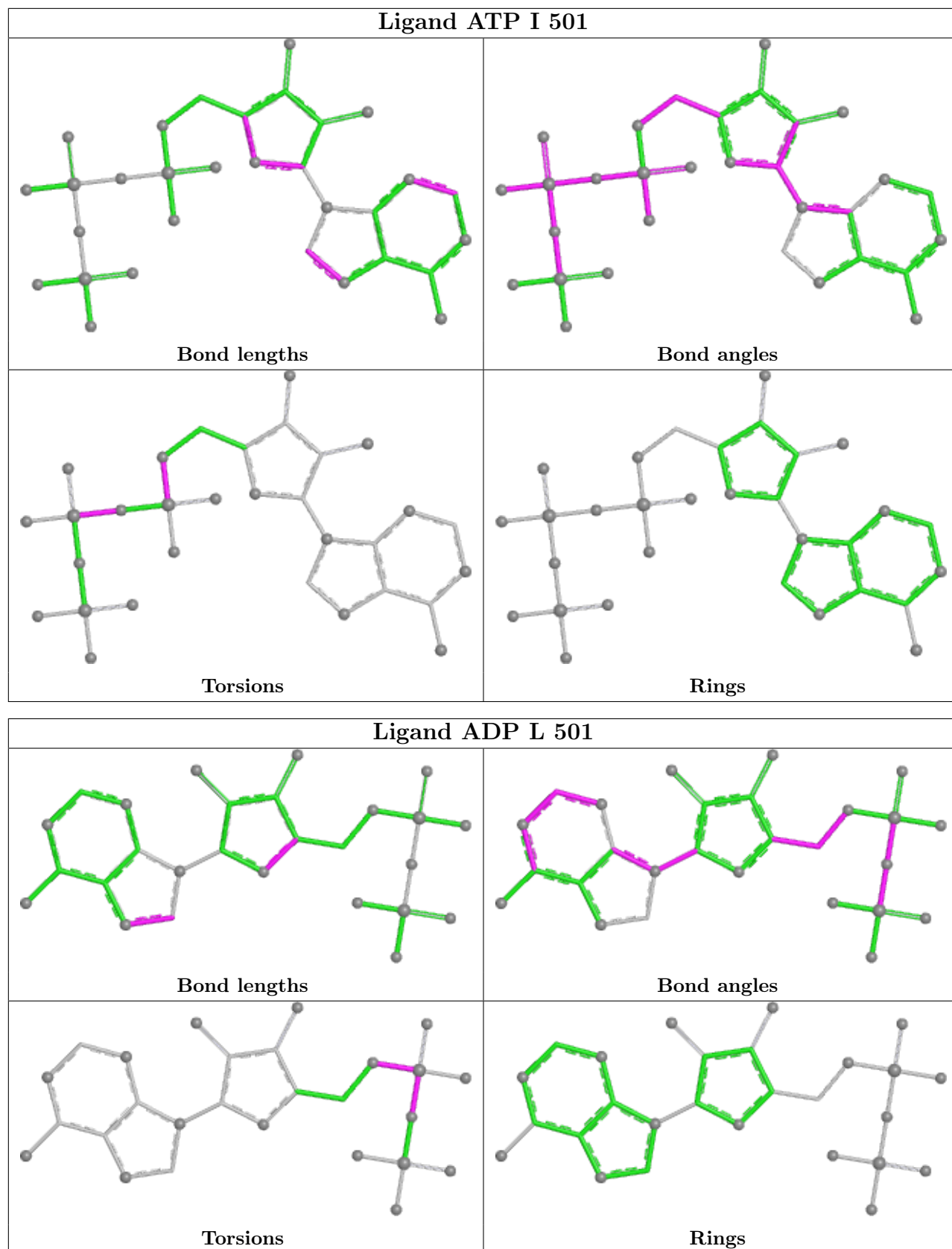

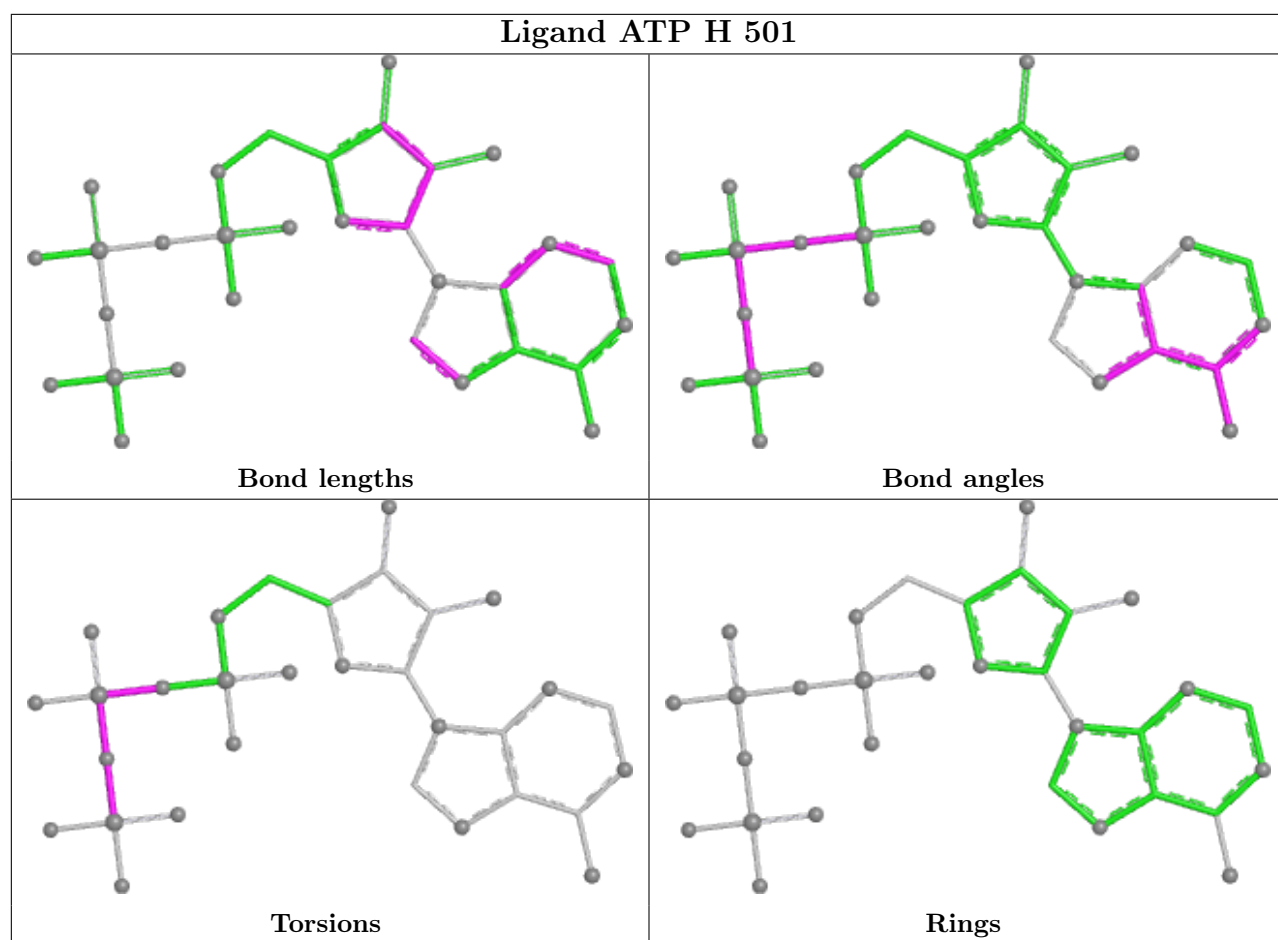

## 5.7 Other polymers [i](#)

There are no such residues in this entry.

## 5.8 Polymer linkage issues [i](#)

There are no chain breaks in this entry.

## 6 Map visualisation [i](#)

This section contains visualisations of the EMDB entry EMD-3537. These allow visual inspection of the internal detail of the map and identification of artifacts.

No raw map or half-maps were deposited for this entry and therefore no images, graphs, etc. pertaining to the raw map can be shown.

### 6.1 Orthogonal projections [i](#)

#### 6.1.1 Primary map

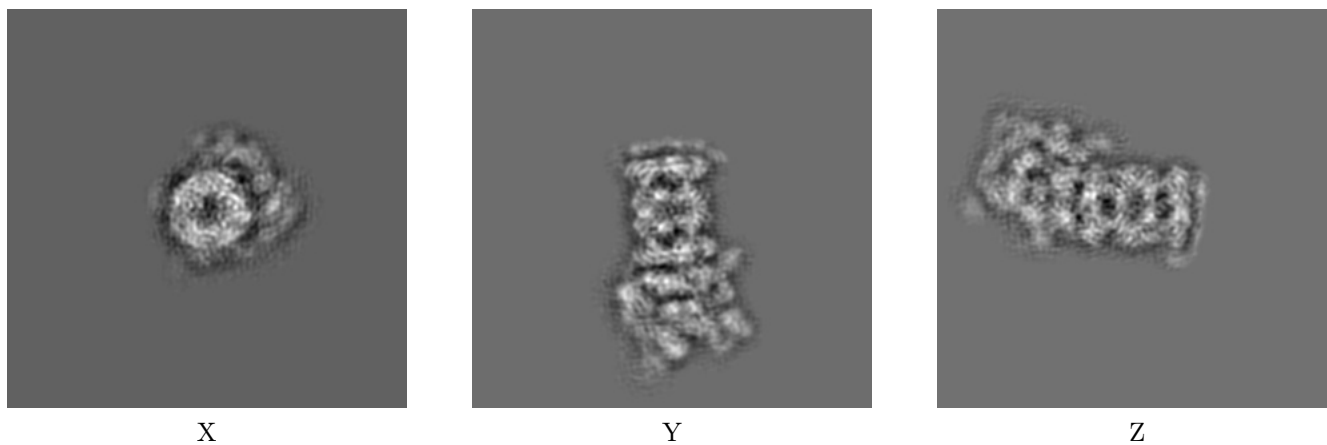

The images above show the map projected in three orthogonal directions.

### 6.2 Central slices [i](#)

#### 6.2.1 Primary map

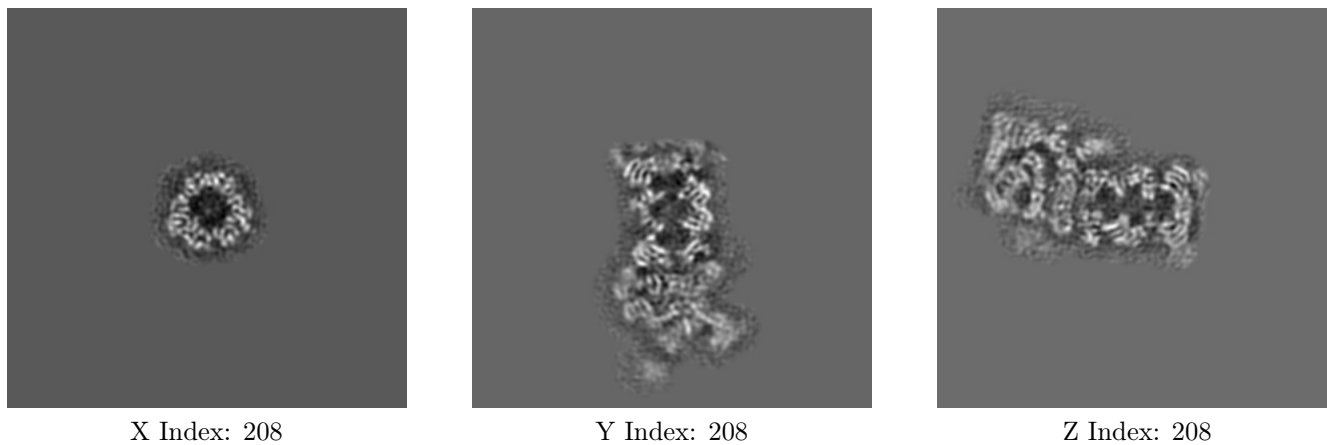

The images above show central slices of the map in three orthogonal directions.

## 6.3 Largest variance slices [i](#)

### 6.3.1 Primary map

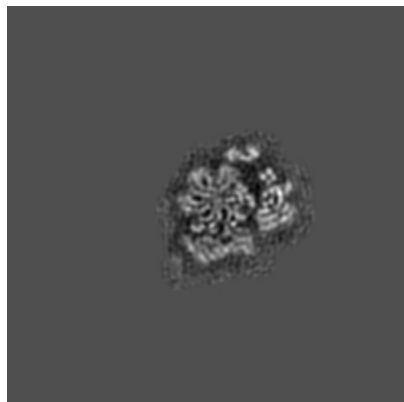

X Index: 126

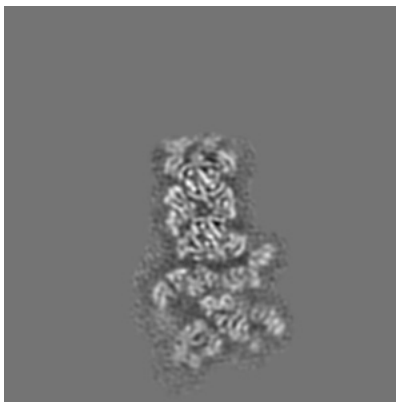

Y Index: 230

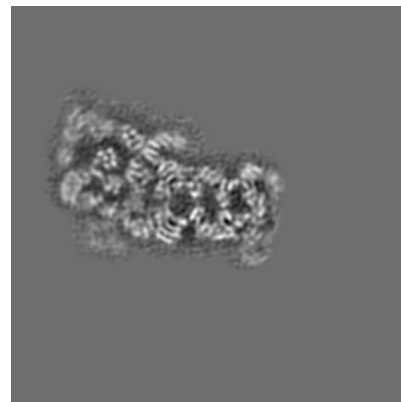

Z Index: 216

The images above show the largest variance slices of the map in three orthogonal directions.

## 6.4 Orthogonal surface views [i](#)

### 6.4.1 Primary map

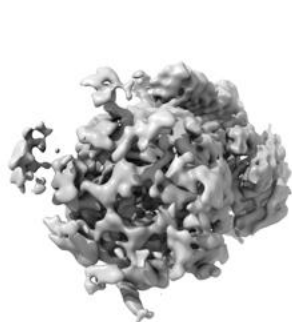

X



Y



Z

The images above show the 3D surface view of the map at the recommended contour level 0.023. These images, in conjunction with the slice images, may facilitate assessment of whether an appropriate contour level has been provided.

## 6.5 Mask visualisation

This section was not generated. No masks/segmentation were deposited.



## 7 Map analysis [i](#)

This section contains the results of statistical analysis of the map.

### 7.1 Map-value distribution [i](#)

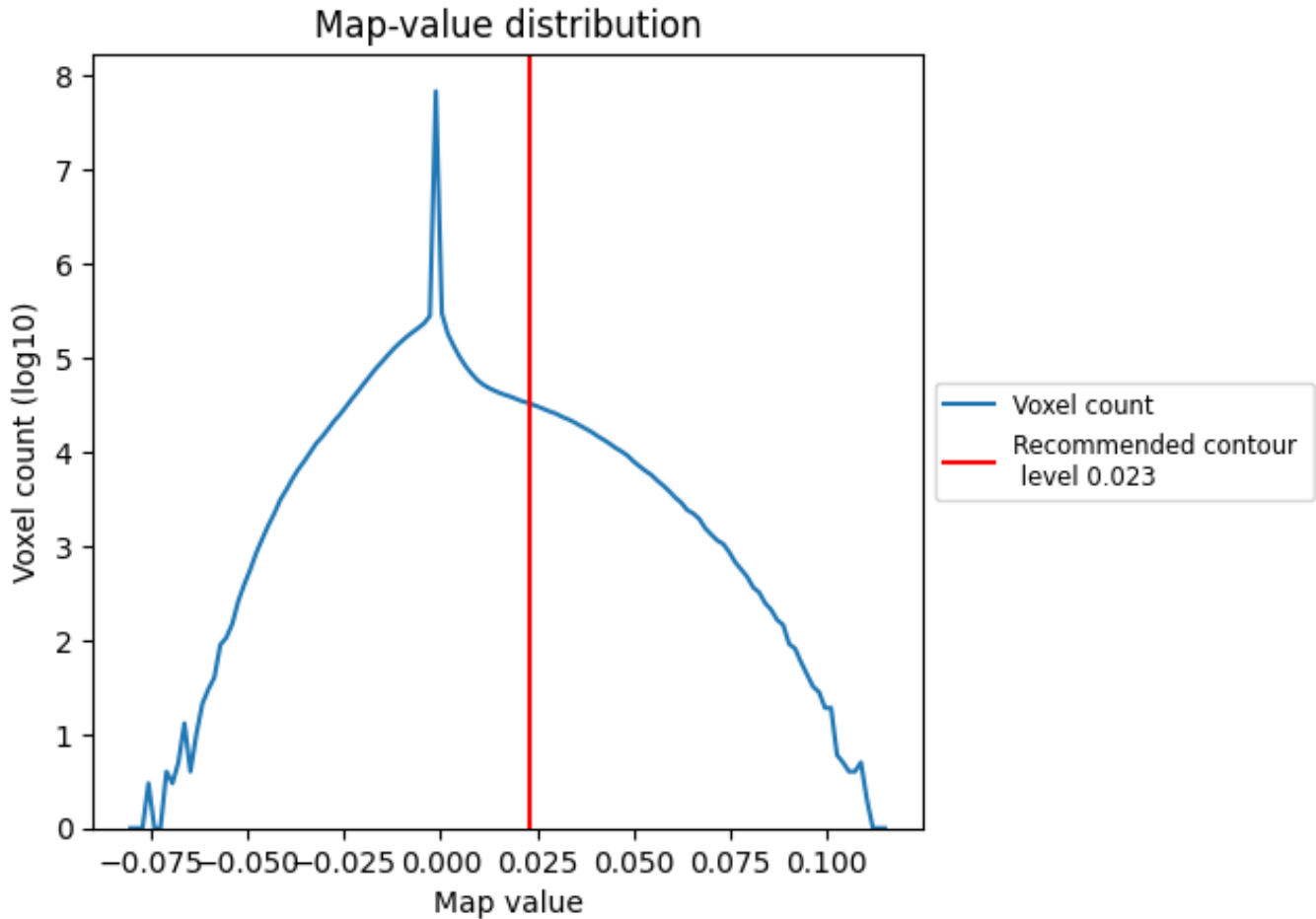

The map-value distribution is plotted in 128 intervals along the x-axis. The y-axis is logarithmic. A spike in this graph at zero usually indicates that the volume has been masked.

## 7.2 Volume estimate [i](#)

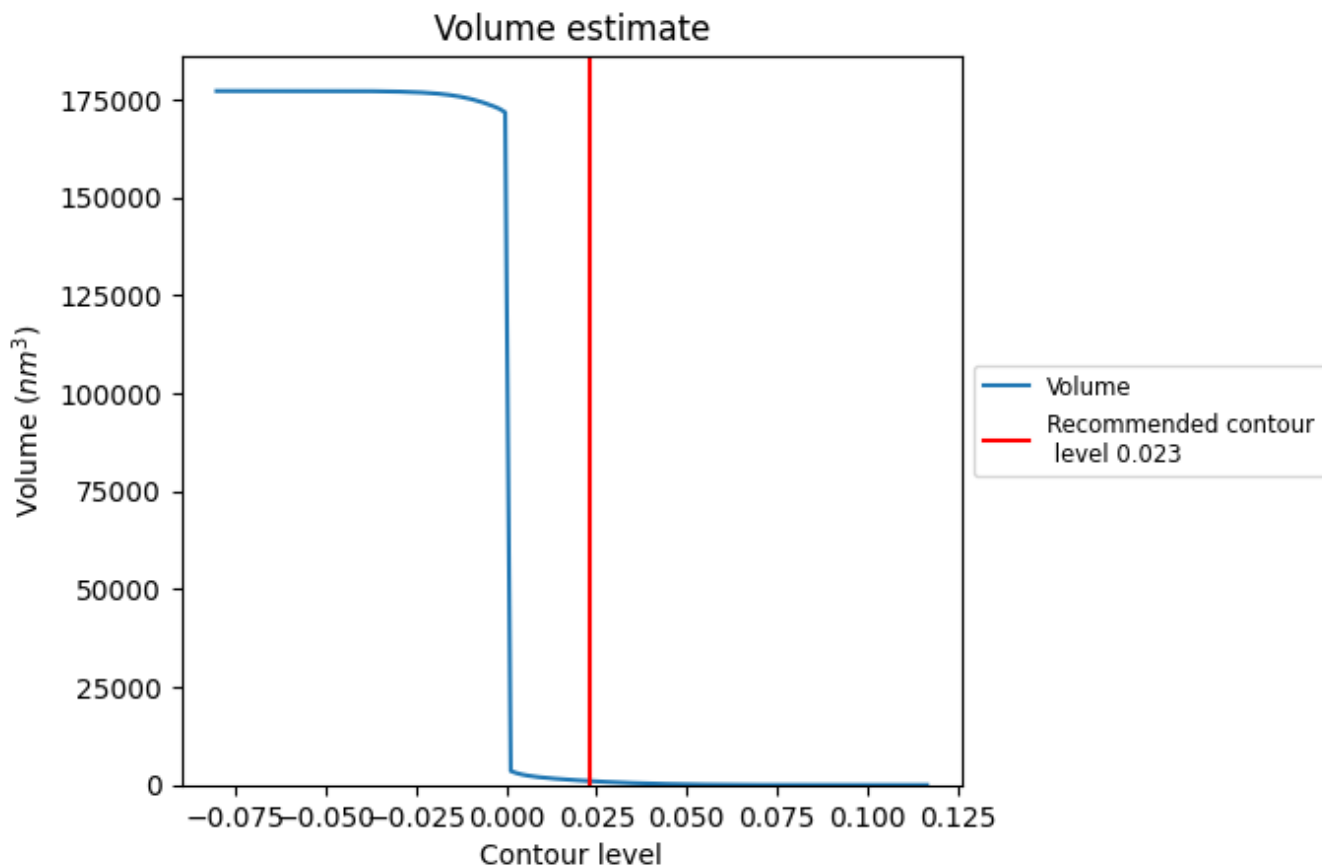

The volume at the recommended contour level is 1008 nm<sup>3</sup>; this corresponds to an approximate mass of 911 kDa.

The volume estimate graph shows how the enclosed volume varies with the contour level. The recommended contour level is shown as a vertical line and the intersection between the line and the curve gives the volume of the enclosed surface at the given level.

### 7.3 Rotationally averaged power spectrum [i](#)

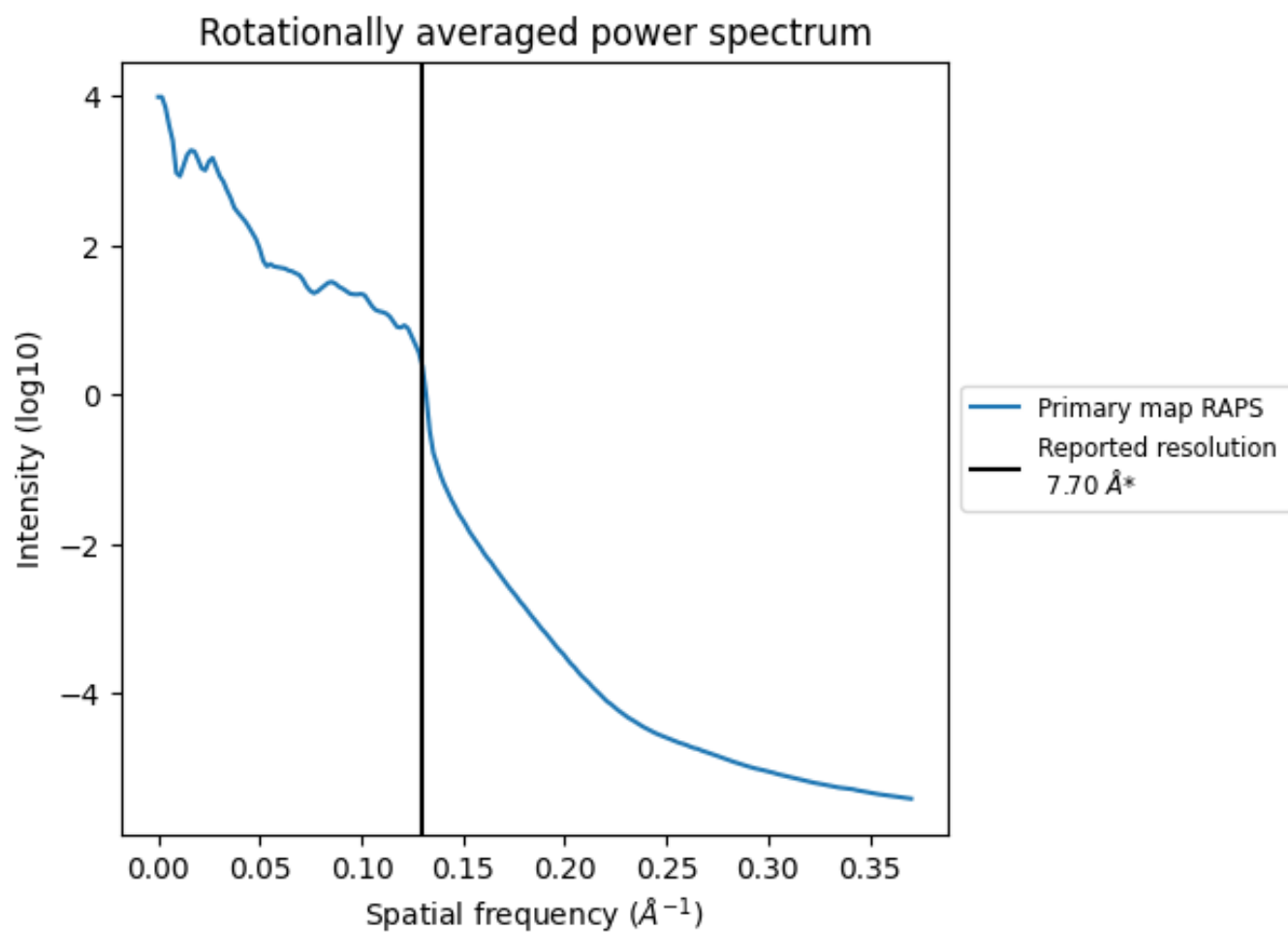

\*Reported resolution corresponds to spatial frequency of  $0.130 \text{\AA}^{-1}$

## 8 Fourier-Shell correlation

This section was not generated. No FSC curve or half-maps provided.

## 9 Map-model fit [i](#)

This section contains information regarding the fit between EMDB map EMD-3537 and PDB model 5MPC. Per-residue inclusion information can be found in section [3](#) on page [13](#).

### 9.1 Map-model overlay [i](#)

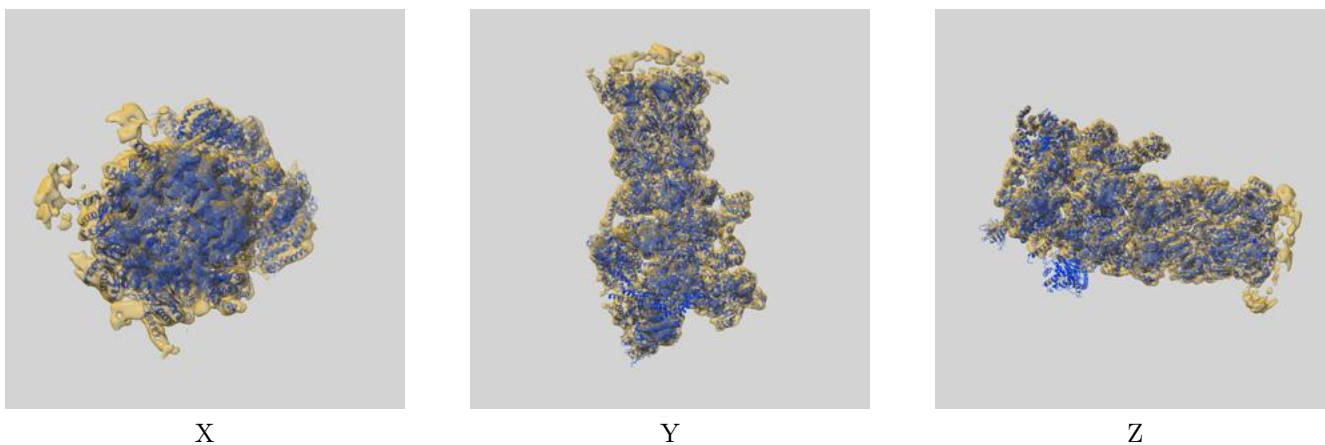

The images above show the 3D surface view of the map at the recommended contour level 0.023 at 50% transparency in yellow overlaid with a ribbon representation of the model coloured in blue. These images allow for the visual assessment of the quality of fit between the atomic model and the map.

## 9.2 Q-score mapped to coordinate model [i](#)

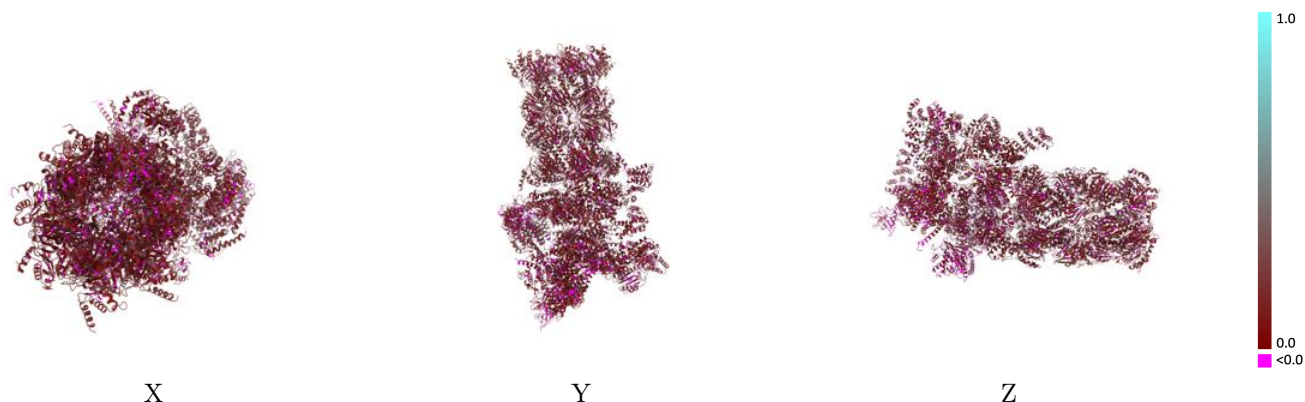

The images above show the model with each residue coloured according to its Q-score. This shows their resolvability in the map with higher Q-score values reflecting better resolvability. Please note: Q-score is calculating the resolvability of atoms, and thus high values are only expected at resolutions at which atoms can be resolved. Low Q-score values may therefore be expected for many entries.

## 9.3 Atom inclusion mapped to coordinate model [i](#)

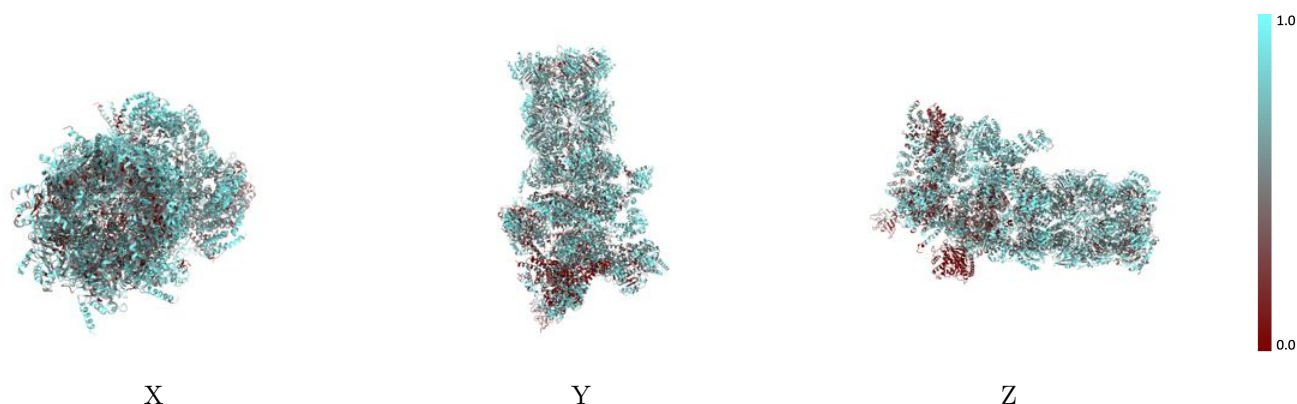

The images above show the model with each residue coloured according to its atom inclusion. This shows to what extent they are inside the map at the recommended contour level (0.023).



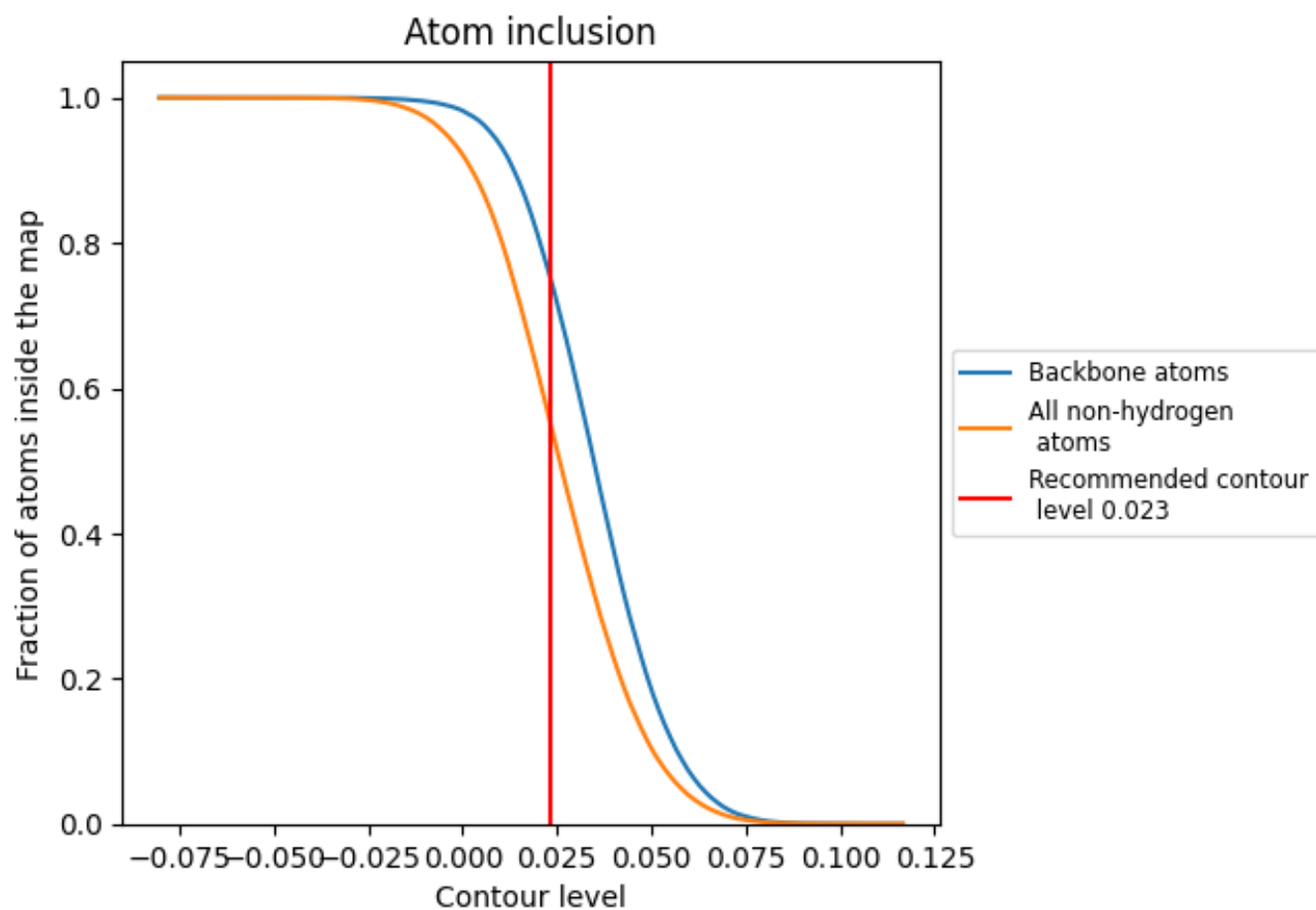



































































## 9.4 Atom inclusion [i](#)



At the recommended contour level, 76% of all backbone atoms, 56% of all non-hydrogen atoms, are inside the map.

## 9.5 Map-model fit summary

The table lists the average atom inclusion at the recommended contour level (0.023) and Q-score for the entire model and for each chain.





























Chain	Atom inclusion	Q-score
All	 0.5573	 0.1350
1	 0.6671	 0.1510
2	 0.6505	 0.1520
3	 0.5713	 0.1440
4	 0.6584	 0.1530
5	 0.6911	 0.1510
6	 0.6632	 0.1460
7	 0.6783	 0.1580
8	 0.0202	 0.0730
A	 0.6408	 0.1500
B	 0.5857	 0.1460
C	 0.5733	 0.1450
D	 0.6101	 0.1450
E	 0.6034	 0.1480
F	 0.6418	 0.1480
G	 0.6633	 0.1450
H	 0.5287	 0.1280
I	 0.4631	 0.1340
J	 0.4632	 0.1230
K	 0.4847	 0.1240
L	 0.4995	 0.1200
M	 0.5329	 0.1350
N	 0.5010	 0.1310
O	 0.6040	 0.1470
P	 0.7570	 0.1490
Q	 0.7037	 0.1430
R	 0.6903	 0.1460
S	 0.4410	 0.1290
T	 0.3330	 0.1250
U	 0.5107	 0.1410
V	 0.5203	 0.1350
W	 0.5483	 0.1110
X	 0.1510	 0.0710
Y	 0.4116	 0.0880
Z	 0.5139	 0.1040



*Continued on next page...*



*Continued from previous page...*

Chain	Atom inclusion	Q-score
a	 0.6211	 0.1460
b	 0.5427	 0.1380
c	 0.5561	 0.1380
d	 0.6150	 0.1420
e	 0.5985	 0.1440
f	 0.6199	 0.1400
g	 0.6445	 0.1500
h	 0.6509	 0.1420
i	 0.6257	 0.1470
j	 0.5848	 0.1390
k	 0.6479	 0.1410
l	 0.6781	 0.1490
m	 0.6551	 0.1510
n	 0.6395	 0.1430