



wwPDB X-ray Structure Validation Summary Report ⓘ

Sep 11, 2023 – 05:19 PM EDT

PDB ID : 4MHJ
Title : Crystal structure of Fab H5M9 in complex with influenza virus hemagglutinin from A/goose/Guangdong/1/96 (H5N1)
Authors : Zhu, X.; Wilson, I.A.
Deposited on : 2013-08-29
Resolution : 6.98 Å(reported)

This is a wwPDB X-ray Structure Validation Summary Report for a publicly released PDB entry.

We welcome your comments at validation@mail.wwpdb.org

A user guide is available at

<https://www.wwpdb.org/validation/2017/XrayValidationReportHelp>

with specific help available everywhere you see the ⓘ symbol.

The types of validation reports are described at

<http://www.wwpdb.org/validation/2017/FAQs#types>.

The following versions of software and data (see [references ⓘ](#)) were used in the production of this report:

MolProbity : 4.02b-467
Mogul : 1.8.5 (274361), CSD as541be (2020)
Xtriage (Phenix) : 1.13
EDS : 2.35.1
Percentile statistics : 20191225.v01 (using entries in the PDB archive December 25th 2019)
Refmac : 5.8.0158
CCP4 : 7.0.044 (Gargrove)
Ideal geometry (proteins) : Engh & Huber (2001)
Ideal geometry (DNA, RNA) : Parkinson et al. (1996)
Validation Pipeline (wwPDB-VP) : 2.35.1

1 Overall quality at a glance

The following experimental techniques were used to determine the structure:

X-RAY DIFFRACTION



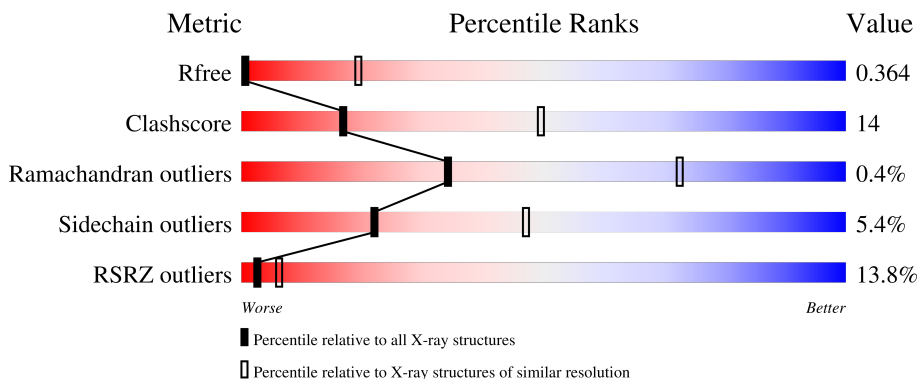

The reported resolution of this entry is 6.98 Å.

Percentile scores (ranging between 0-100) for global validation metrics of the entry are shown in the following graphic. The table shows the number of entries on which the scores are based.

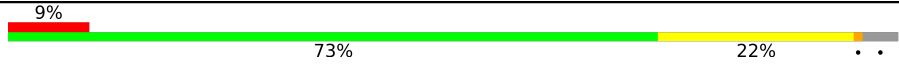

Metric	Whole archive (#Entries)	Similar resolution (#Entries, resolution range(Å))
R_{free}	130704	1004 (10.00-3.90)
Clashscore	141614	1069 (10.00-3.90)
Ramachandran outliers	138981	1002 (10.00-3.90)
Sidechain outliers	138945	1002 (10.00-3.86)
RSRZ outliers	127900	1004 (9.50-3.80)

The table below summarises the geometric issues observed across the polymeric chains and their fit to the electron density. The red, orange, yellow and green segments of the lower bar indicate the fraction of residues that contain outliers for ≥ 3 , 2, 1 and 0 types of geometric quality criteria respectively. A grey segment represents the fraction of residues that are not modelled. The numeric value for each fraction is indicated below the corresponding segment, with a dot representing fractions $\leq 5\%$. The upper red bar (where present) indicates the fraction of residues that have poor fit to the electron density. The numeric value is given above the bar.

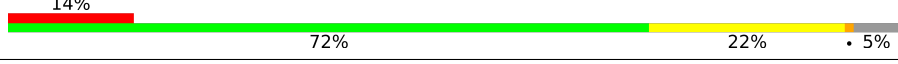
Mol	Chain	Length	Quality of chain
1	A	334	
1	C	334	
1	G	334	
1	M	334	
1	O	334	



Continued on next page...

Continued from previous page...

Mol	Chain	Length	Quality of chain
1	S	334	11% 74% 22% 5%
2	B	182	5% 81% 13% 5%
2	D	182	7% 75% 19% 5%
2	I	182	12% 77% 18% 5%
2	N	182	8% 77% 15% 7%
2	P	182	4% 79% 15% 5%
2	U	182	3% 74% 20% 5%
3	E	218	20% 66% 30% 5%
3	J	218	15% 63% 30% 5%
3	L	218	11% 65% 30% 5%
3	Q	218	12% 68% 27% 5%
3	V	218	25% 65% 30% 5%
3	X	218	6% 63% 33% 5%
4	F	222	19% 68% 28% 5%
4	H	222	27% 66% 28% 5%
4	K	222	19% 68% 27% 5%
4	R	222	18% 70% 26% 5%
4	T	222	17% 65% 29% 5%
4	W	222	24% 66% 29% 5%
5	Y	3	33% 67%
5	d	3	100%
5	f	3	100%
6	Z	8	100%
7	a	2	100%
7	c	2	100%

Continued on next page...

Continued from previous page...

Mol	Chain	Length	Quality of chain
8	b	3	 67% 33%
9	e	4	 25% 75%

The following table lists non-polymeric compounds, carbohydrate monomers and non-standard residues in protein, DNA, RNA chains that are outliers for geometric or electron-density-fit criteria:

Mol	Type	Chain	Res	Chirality	Geometry	Clashes	Electron density
10	NAG	A	2004	-	-	-	X
10	NAG	P	2001	-	-	-	X
10	NAG	S	2004	-	-	-	X
5	NAG	Y	2	-	-	-	X
5	MAN	Y	3	-	-	-	X
5	NAG	d	1	-	-	-	X
5	MAN	d	3	-	-	-	X
6	MAN	Z	5	-	-	-	X
7	NAG	c	1	-	-	-	X
7	NAG	c	2	-	-	-	X
8	BMA	b	3	-	-	-	X
9	NAG	e	1	-	-	-	X
9	MAN	e	4	-	-	-	X

2 Entry composition i

There are 10 unique types of molecules in this entry. The entry contains 43995 atoms, of which 0 are hydrogens and 0 are deuteriums.

In the tables below, the ZeroOcc column contains the number of atoms modelled with zero occupancy, the AltConf column contains the number of residues with at least one atom in alternate conformation and the Trace column contains the number of residues modelled with at most 2 atoms.

- Molecule 1 is a protein called Hemagglutinin HA1 chain.

Mol	Chain	Residues	Atoms					ZeroOcc	AltConf	Trace
			Total	C	N	O	S			
1	A	322	2542	1603	440	484	15	0	0	0
1	C	321	2533	1598	438	482	15	0	0	0
1	G	321	2530	1594	439	482	15	0	0	0
1	M	322	2542	1603	440	484	15	0	0	0
1	O	318	2514	1587	435	477	15	0	0	0
1	S	322	2542	1603	440	484	15	0	0	0

There are 24 discrepancies between the modelled and reference sequences:

Chain	Residue	Modelled	Actual	Comment	Reference
A	7	ALA	-	expression tag	UNP Q9Q0U6
A	8	ASP	-	expression tag	UNP Q9Q0U6
A	9	PRO	-	expression tag	UNP Q9Q0U6
A	10	GLY	-	expression tag	UNP Q9Q0U6
C	7	ALA	-	expression tag	UNP Q9Q0U6
C	8	ASP	-	expression tag	UNP Q9Q0U6
C	9	PRO	-	expression tag	UNP Q9Q0U6
C	10	GLY	-	expression tag	UNP Q9Q0U6
G	7	ALA	-	expression tag	UNP Q9Q0U6
G	8	ASP	-	expression tag	UNP Q9Q0U6
G	9	PRO	-	expression tag	UNP Q9Q0U6
G	10	GLY	-	expression tag	UNP Q9Q0U6
M	7	ALA	-	expression tag	UNP Q9Q0U6
M	8	ASP	-	expression tag	UNP Q9Q0U6
M	9	PRO	-	expression tag	UNP Q9Q0U6
M	10	GLY	-	expression tag	UNP Q9Q0U6
O	7	ALA	-	expression tag	UNP Q9Q0U6

Continued on next page...

Continued from previous page...

Chain	Residue	Modelled	Actual	Comment	Reference
O	8	ASP	-	expression tag	UNP Q9Q0U6
O	9	PRO	-	expression tag	UNP Q9Q0U6
O	10	GLY	-	expression tag	UNP Q9Q0U6
S	7	ALA	-	expression tag	UNP Q9Q0U6
S	8	ASP	-	expression tag	UNP Q9Q0U6
S	9	PRO	-	expression tag	UNP Q9Q0U6
S	10	GLY	-	expression tag	UNP Q9Q0U6

- Molecule 2 is a protein called Hemagglutinin HA2 chain.

Mol	Chain	Residues	Atoms					ZeroOcc	AltConf	Trace
			Total	C	N	O	S			
2	B	172	Total 1393	C 866	N 239	O 280	S 8	0	0	0
2	D	172	Total 1393	C 866	N 239	O 280	S 8	0	0	0
2	N	169	Total 1363	C 846	N 233	O 276	S 8	0	0	0
2	P	172	Total 1393	C 866	N 239	O 280	S 8	0	0	0
2	I	173	Total 1403	C 872	N 242	O 281	S 8	0	0	0
2	U	173	Total 1403	C 872	N 242	O 281	S 8	0	0	0

There are 42 discrepancies between the modelled and reference sequences:

Chain	Residue	Modelled	Actual	Comment	Reference
B	176	SER	-	expression tag	UNP Q9Q0U6
B	177	GLY	-	expression tag	UNP Q9Q0U6
B	178	ARG	-	expression tag	UNP Q9Q0U6
B	179	LEU	-	expression tag	UNP Q9Q0U6
B	180	VAL	-	expression tag	UNP Q9Q0U6
B	181	PRO	-	expression tag	UNP Q9Q0U6
B	182	ARG	-	expression tag	UNP Q9Q0U6
D	176	SER	-	expression tag	UNP Q9Q0U6
D	177	GLY	-	expression tag	UNP Q9Q0U6
D	178	ARG	-	expression tag	UNP Q9Q0U6
D	179	LEU	-	expression tag	UNP Q9Q0U6
D	180	VAL	-	expression tag	UNP Q9Q0U6
D	181	PRO	-	expression tag	UNP Q9Q0U6
D	182	ARG	-	expression tag	UNP Q9Q0U6
N	176	SER	-	expression tag	UNP Q9Q0U6

Continued on next page...

Continued from previous page...

Chain	Residue	Modelled	Actual	Comment	Reference
N	177	GLY	-	expression tag	UNP Q9Q0U6
N	178	ARG	-	expression tag	UNP Q9Q0U6
N	179	LEU	-	expression tag	UNP Q9Q0U6
N	180	VAL	-	expression tag	UNP Q9Q0U6
N	181	PRO	-	expression tag	UNP Q9Q0U6
N	182	ARG	-	expression tag	UNP Q9Q0U6
P	176	SER	-	expression tag	UNP Q9Q0U6
P	177	GLY	-	expression tag	UNP Q9Q0U6
P	178	ARG	-	expression tag	UNP Q9Q0U6
P	179	LEU	-	expression tag	UNP Q9Q0U6
P	180	VAL	-	expression tag	UNP Q9Q0U6
P	181	PRO	-	expression tag	UNP Q9Q0U6
P	182	ARG	-	expression tag	UNP Q9Q0U6
I	176	SER	-	expression tag	UNP Q9Q0U6
I	177	GLY	-	expression tag	UNP Q9Q0U6
I	178	ARG	-	expression tag	UNP Q9Q0U6
I	179	LEU	-	expression tag	UNP Q9Q0U6
I	180	VAL	-	expression tag	UNP Q9Q0U6
I	181	PRO	-	expression tag	UNP Q9Q0U6
I	182	ARG	-	expression tag	UNP Q9Q0U6
U	176	SER	-	expression tag	UNP Q9Q0U6
U	177	GLY	-	expression tag	UNP Q9Q0U6
U	178	ARG	-	expression tag	UNP Q9Q0U6
U	179	LEU	-	expression tag	UNP Q9Q0U6
U	180	VAL	-	expression tag	UNP Q9Q0U6
U	181	PRO	-	expression tag	UNP Q9Q0U6
U	182	ARG	-	expression tag	UNP Q9Q0U6

- Molecule 3 is a protein called H5M9 antibody, light chain (kappa).

Mol	Chain	Residues	Atoms					ZeroOcc	AltConf	Trace
3	L	215	Total	C	N	O	S	0	0	0
			1666	1032	289	339	6			
3	E	216	Total	C	N	O	S	0	0	0
			1672	1035	290	341	6			
3	J	211	Total	C	N	O	S	0	0	0
			1634	1015	280	333	6			
3	X	216	Total	C	N	O	S	0	0	0
			1672	1035	290	341	6			
3	Q	215	Total	C	N	O	S	0	0	0
			1665	1031	289	339	6			
3	V	214	Total	C	N	O	S	0	0	0
			1655	1026	285	338	6			

- Molecule 4 is a protein called H5M9 antibody, heavy chain (IgG1).

Mol	Chain	Residues	Atoms					ZeroOcc	AltConf	Trace
4	H	221	Total	C	N	O	S	0	0	0
			1675	1059	276	331	9			
4	F	221	Total	C	N	O	S	0	0	0
			1675	1059	276	331	9			
4	K	221	Total	C	N	O	S	0	0	0
			1674	1057	276	332	9			
4	T	220	Total	C	N	O	S	0	0	0
			1666	1054	274	329	9			
4	R	221	Total	C	N	O	S	0	0	0
			1675	1059	276	331	9			
4	W	221	Total	C	N	O	S	0	0	0
			1675	1059	276	331	9			

- Molecule 5 is an oligosaccharide called alpha-D-mannopyranose-(1-4)-2-acetamido-2-deoxy-beta-D-glucopyranose-(1-4)-2-acetamido-2-deoxy-beta-D-glucopyranose.



Mol	Chain	Residues	Atoms				ZeroOcc	AltConf	Trace
5	Y	3	Total	C	N	O	0	0	0
			39	22	2	15			
5	d	3	Total	C	N	O	0	0	0
			39	22	2	15			
5	f	3	Total	C	N	O	0	0	0
			39	22	2	15			

- Molecule 6 is an oligosaccharide called alpha-D-mannopyranose-(1-2)-alpha-D-mannopyranose-(1-3)-[alpha-D-mannopyranose-(1-2)-alpha-D-mannopyranose-(1-6)]alpha-D-mannopyranose-(1-6)-beta-D-mannopyranose-(1-4)-2-acetamido-2-deoxy-beta-D-glucopyranose-(1-4)-2-acetamido-2-deoxy-beta-D-glucopyranose.

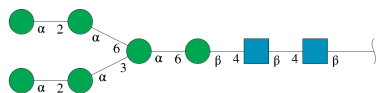

Mol	Chain	Residues	Atoms				ZeroOcc	AltConf	Trace
6	Z	8	Total	C	N	O	0	0	0
			94	52	2	40			

- Molecule 7 is an oligosaccharide called 2-acetamido-2-deoxy-beta-D-glucopyranose-(1-4)-2-acetamido-2-deoxy-beta-D-glucopyranose.



Mol	Chain	Residues	Atoms				ZeroOcc	AltConf	Trace
			Total	C	N	O			
7	a	2	28	16	2	10	0	0	0
7	c	2	28	16	2	10	0	0	0

- Molecule 8 is an oligosaccharide called beta-D-mannopyranose-(1-4)-2-acetamido-2-deoxy-beta-D-glucopyranose-(1-4)-2-acetamido-2-deoxy-beta-D-glucopyranose.

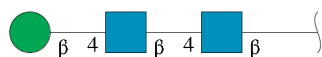

Mol	Chain	Residues	Atoms				ZeroOcc	AltConf	Trace
			Total	C	N	O			
8	b	3	39	22	2	15	0	0	0

- Molecule 9 is an oligosaccharide called alpha-D-mannopyranose-(1-3)-beta-D-mannopyranose-(1-4)-2-acetamido-2-deoxy-beta-D-glucopyranose-(1-4)-2-acetamido-2-deoxy-beta-D-glucopyranose.



Mol	Chain	Residues	Atoms				ZeroOcc	AltConf	Trace
			Total	C	N	O			
9	e	4	50	28	2	20	0	0	0

- Molecule 10 is 2-acetamido-2-deoxy-beta-D-glucopyranose (three-letter code: NAG) (formula: C₈H₁₅NO₆).



Mol	Chain	Residues	Atoms				ZeroOcc	AltConf
			Total	C	N	O		
10	A	1	Total 14	8	1	5	0	0
10	C	1	Total 14	8	1	5	0	0
10	M	1	Total 14	8	1	5	0	0
10	O	1	Total 14	8	1	5	0	0
10	P	1	Total 14	8	1	5	0	0
10	S	1	Total 14	8	1	5	0	0

3 Residue-property plots [i](#)

These plots are drawn for all protein, RNA, DNA and oligosaccharide chains in the entry. The first graphic for a chain summarises the proportions of the various outlier classes displayed in the second graphic. The second graphic shows the sequence view annotated by issues in geometry and electron density. Residues are color-coded according to the number of geometric quality criteria for which they contain at least one outlier: green = 0, yellow = 1, orange = 2 and red = 3 or more. A red dot above a residue indicates a poor fit to the electron density ($RSRZ > 2$). Stretches of 2 or more consecutive residues without any outlier are shown as a green connector. Residues present in the sample, but not in the model, are shown in grey.

- Molecule 1: Hemagglutinin HA1 chain

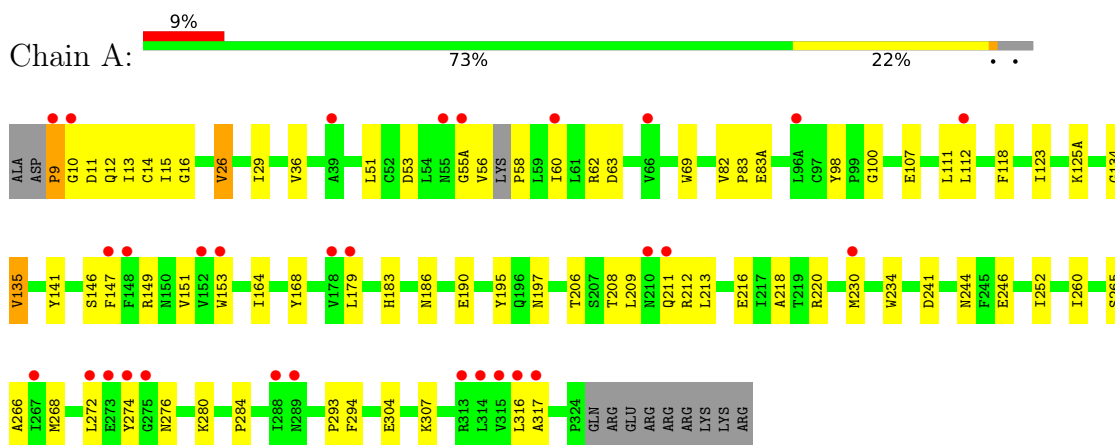

- Molecule 1: Hemagglutinin HA1 chain

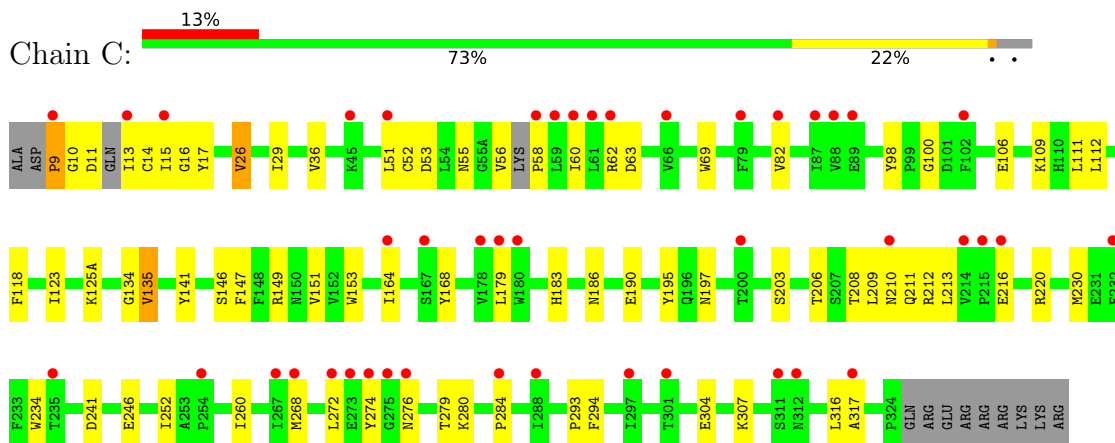

- Molecule 1: Hemagglutinin HA1 chain

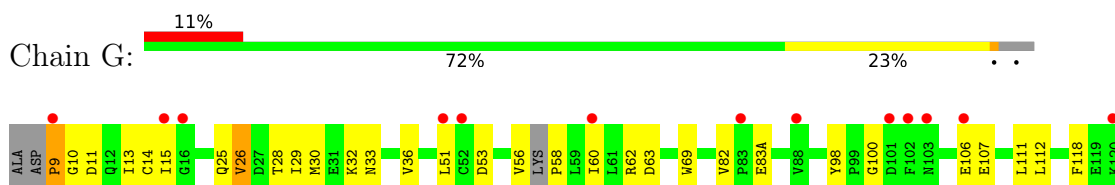

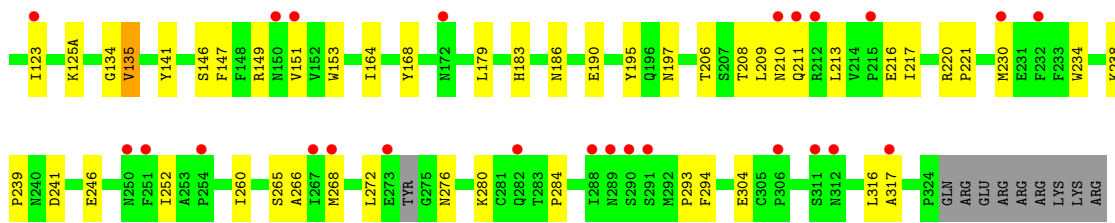

• Molecule 1: Hemagglutinin HA1 chain

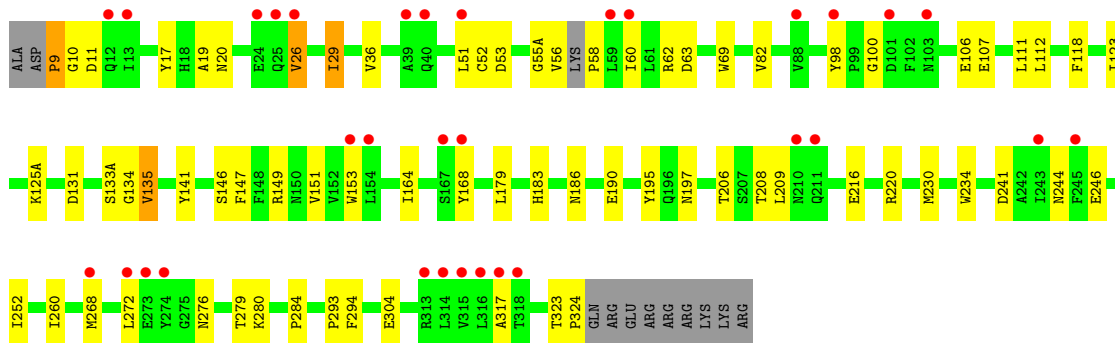
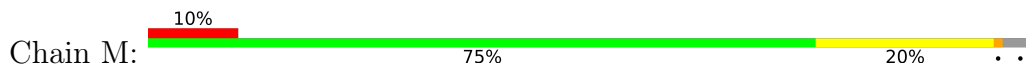

• Molecule 1: Hemagglutinin HA1 chain

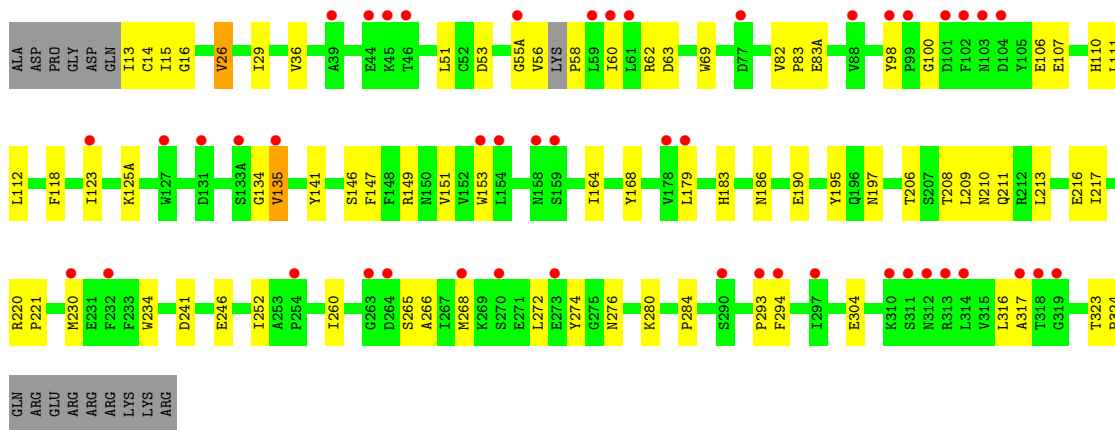

• Molecule 1: Hemagglutinin HA1 chain

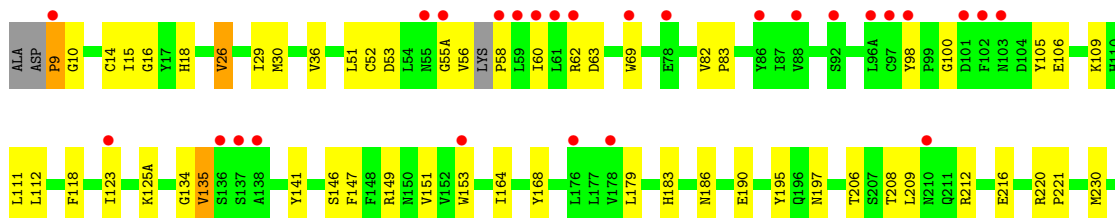

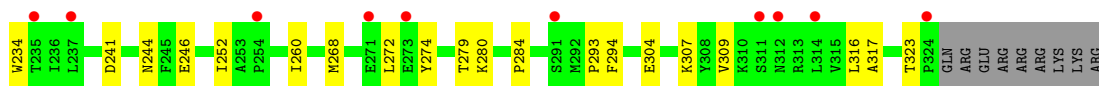

• Molecule 2: Hemagglutinin HA2 chain

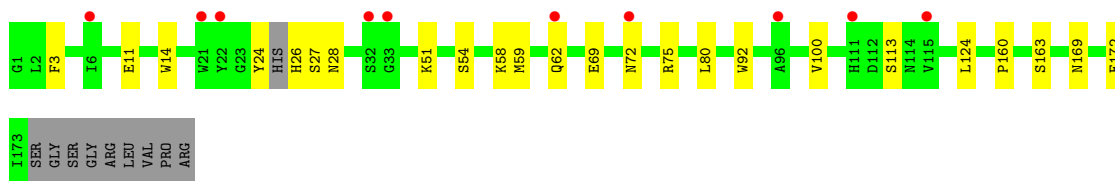
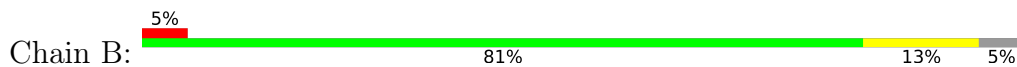

• Molecule 2: Hemagglutinin HA2 chain

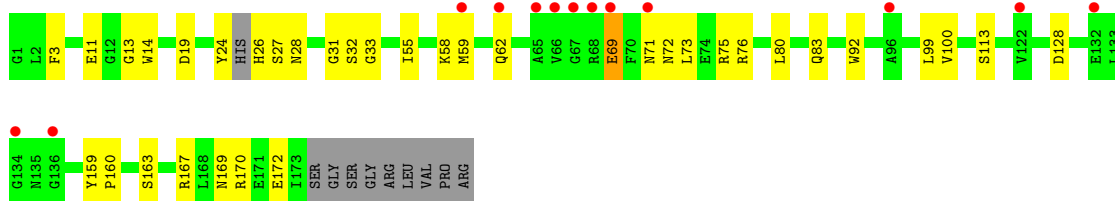
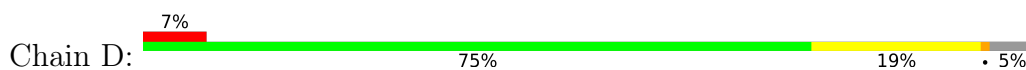

• Molecule 2: Hemagglutinin HA2 chain

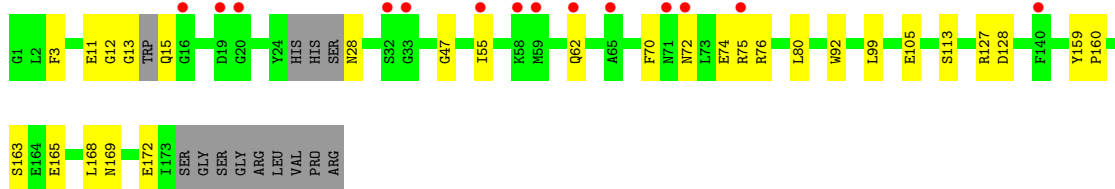
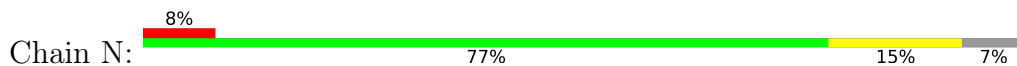

• Molecule 2: Hemagglutinin HA2 chain

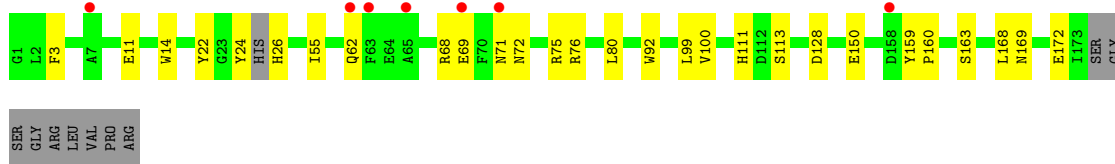
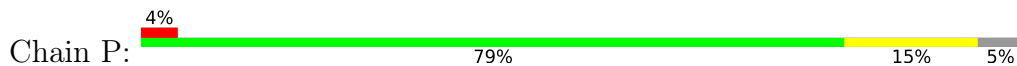

• Molecule 2: Hemagglutinin HA2 chain

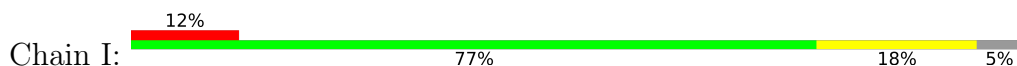

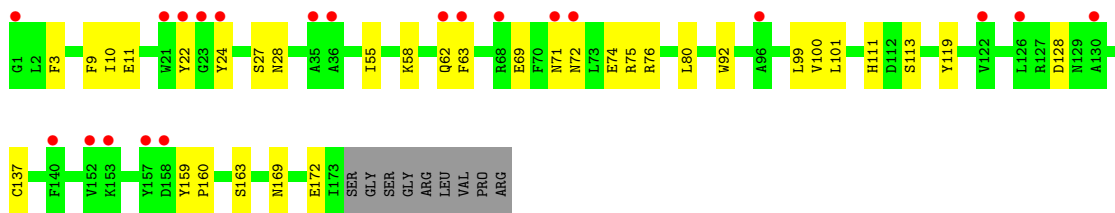

• Molecule 2: Hemagglutinin HA2 chain

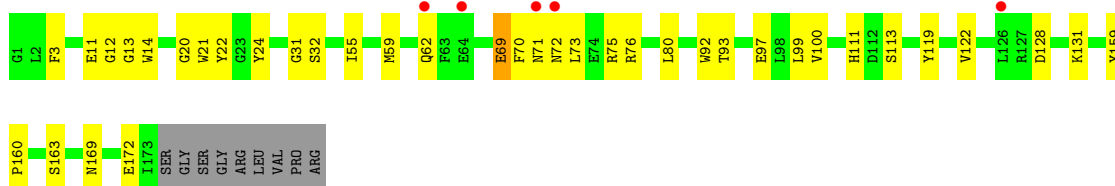
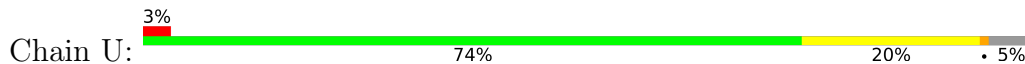

• Molecule 3: H5M9 antibody, light chain (kappa)

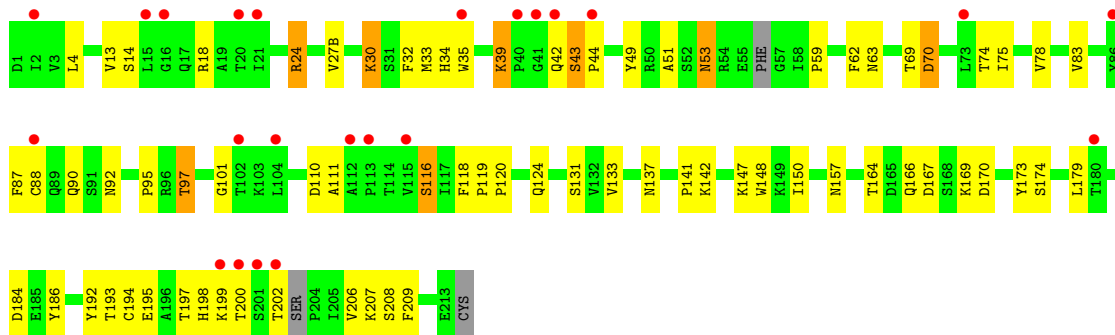

• Molecule 3: H5M9 antibody, light chain (kappa)

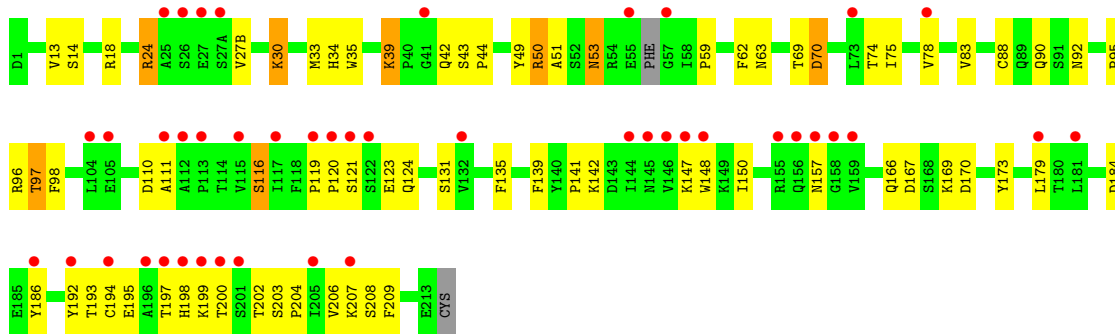

• Molecule 3: H5M9 antibody, light chain (kappa)



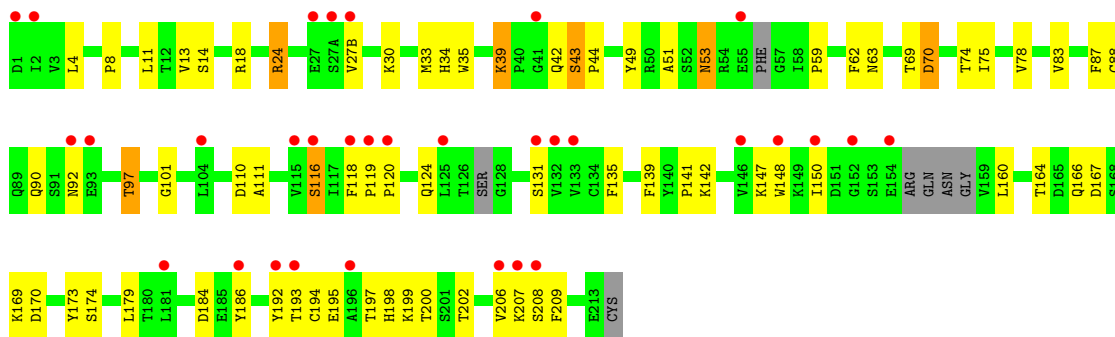

• Molecule 3: H5M9 antibody, light chain (kappa)

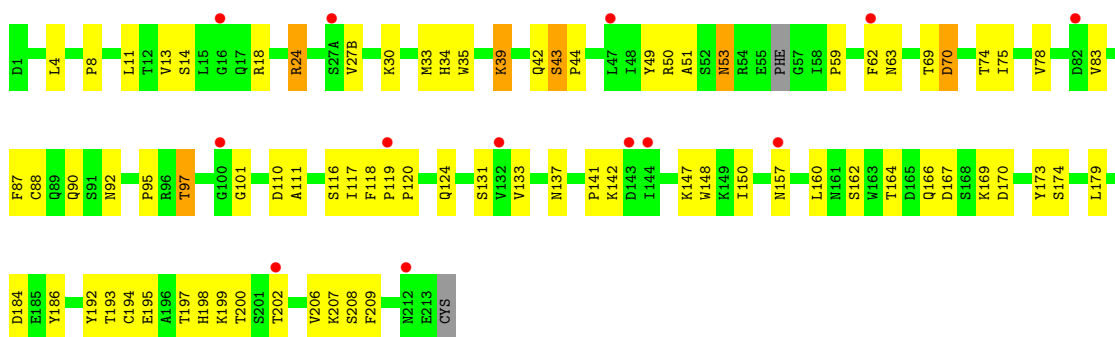

• Molecule 3: H5M9 antibody, light chain (kappa)

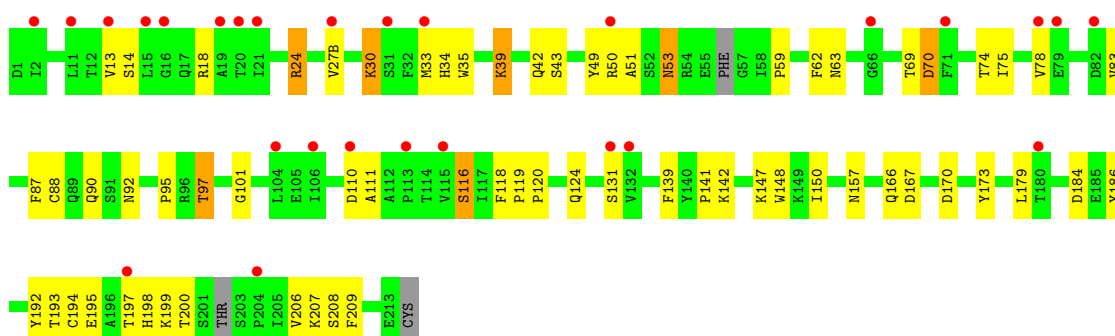

• Molecule 3: H5M9 antibody, light chain (kappa)

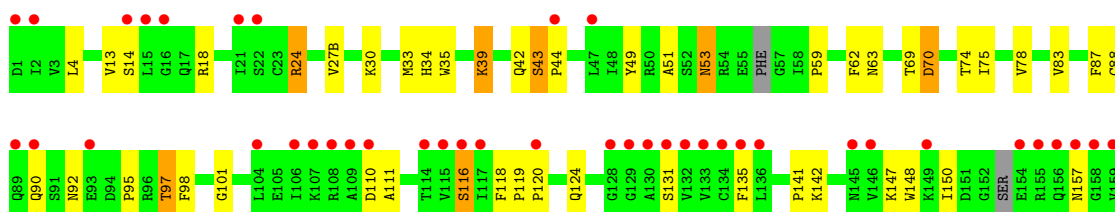



● Molecule 4: H5M9 antibody, heavy chain (IgG1)

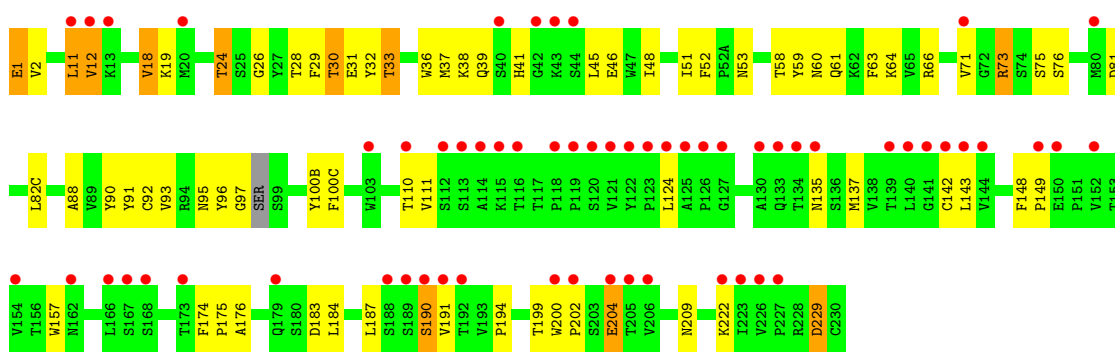

● Molecule 4: H5M9 antibody, heavy chain (IgG1)

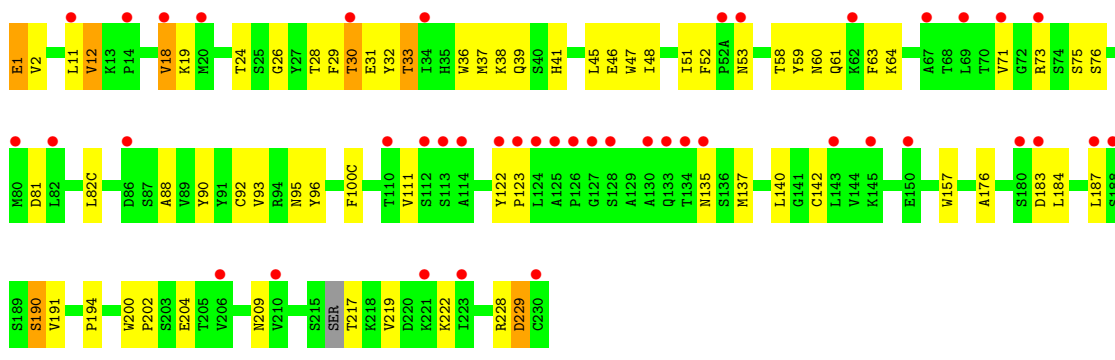

● Molecule 4: H5M9 antibody, heavy chain (IgG1)

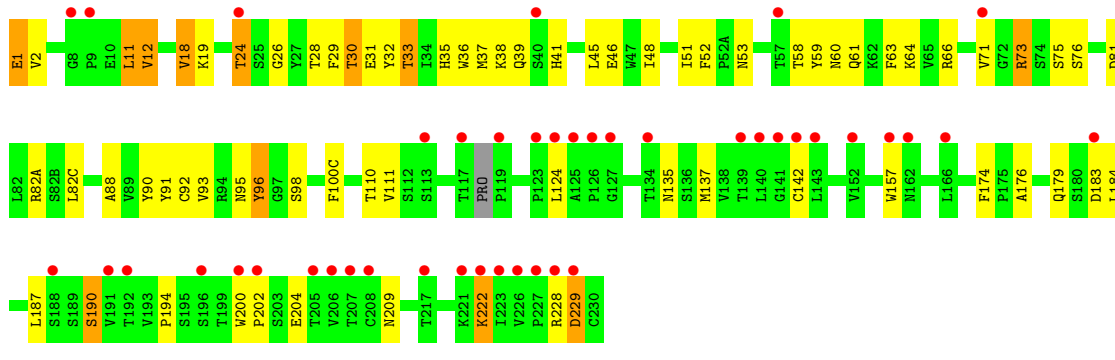

● Molecule 4: H5M9 antibody, heavy chain (IgG1)

Chain T: 

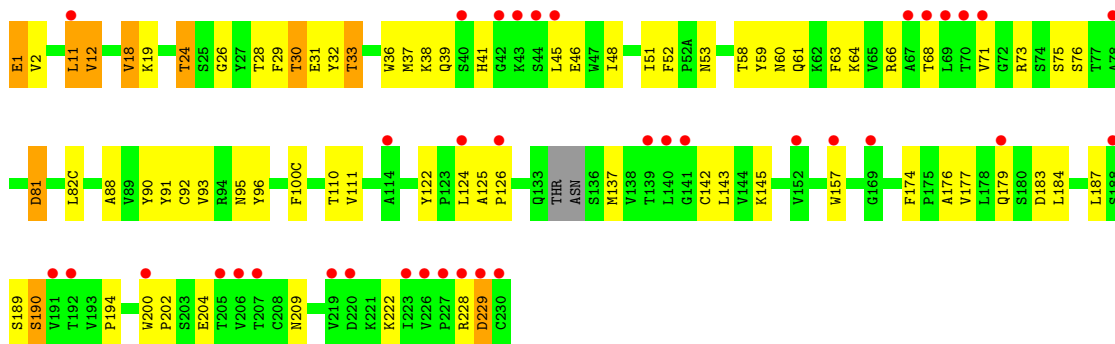

• Molecule 4: H5M9 antibody, heavy chain (IgG1)

Chain R: 

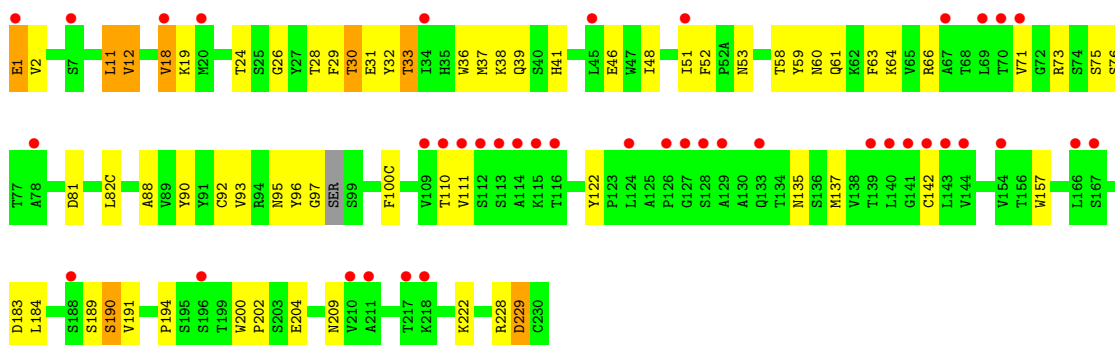

• Molecule 4: H5M9 antibody, heavy chain (IgG1)

Chain W: 

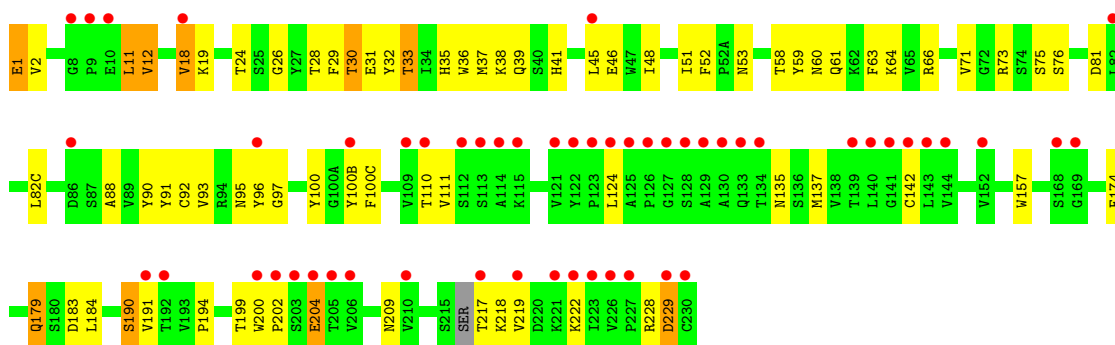

• Molecule 5: alpha-D-mannopyranose-(1-4)-2-acetamido-2-deoxy-beta-D-glucopyranose-(1-4)-2-acetamido-2-deoxy-beta-D-glucopyranose

Chain Y: 



- Molecule 5: alpha-D-mannopyranose-(1-4)-2-acetamido-2-deoxy-beta-D-glucopyranose-(1-4)-2-acetamido-2-deoxy-beta-D-glucopyranose

Chain d:  100%

MAG1
MAG2
MAN3

- Molecule 5: alpha-D-mannopyranose-(1-4)-2-acetamido-2-deoxy-beta-D-glucopyranose-(1-4)-2-acetamido-2-deoxy-beta-D-glucopyranose

Chain f:  100%

MAG1
MAG2
MAN3

- Molecule 6: alpha-D-mannopyranose-(1-2)-alpha-D-mannopyranose-(1-3)-[alpha-D-mannopyranose-(1-2)-alpha-D-mannopyranose-(1-6)]alpha-D-mannopyranose-(1-6)-beta-D-mannopyranose-(1-4)-2-acetamido-2-deoxy-beta-D-glucopyranose-(1-4)-2-acetamido-2-deoxy-beta-D-glucopyranose

Chain Z:  100%

MAG1
MAG2
BMA3
MAN4
MAN5
MAN6
MAN7
MAN8

- Molecule 7: 2-acetamido-2-deoxy-beta-D-glucopyranose-(1-4)-2-acetamido-2-deoxy-beta-D-glucopyranose

Chain a:  100%

MAG1
MAG2

- Molecule 7: 2-acetamido-2-deoxy-beta-D-glucopyranose-(1-4)-2-acetamido-2-deoxy-beta-D-glucopyranose

Chain c:  100%

MAG1
MAG2

- Molecule 8: beta-D-mannopyranose-(1-4)-2-acetamido-2-deoxy-beta-D-glucopyranose-(1-4)-2-acetamido-2-deoxy-beta-D-glucopyranose

Chain b:  67% 33%

MAG1
MAG2
BMA3

- Molecule 9: alpha-D-mannopyranose-(1-3)-beta-D-mannopyranose-(1-4)-2-acetamido-2-deoxy-beta-D-glucopyranose-(1-4)-2-acetamido-2-deoxy-beta-D-glucopyranose

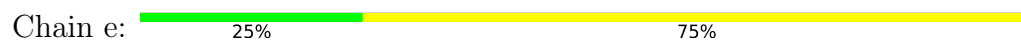

MAG1	MAG2	MAG3	MAG4
------	------	------	------

4 Data and refinement statistics i

Property	Value	Source
Space group	P 31 2 1	Depositor
Cell constants a, b, c, α , β , γ	199.55Å 199.55Å 466.89Å 90.00° 90.00° 120.00°	Depositor
Resolution (Å)	50.08 – 6.98 50.03 – 6.98	Depositor EDS
% Data completeness (in resolution range)	92.7 (50.08-6.98) 93.0 (50.03-6.98)	Depositor EDS
R_{merge}	(Not available)	Depositor
R_{sym}	0.14	Depositor
$\langle I/\sigma(I) \rangle$ ¹	1.56 (at 6.68Å)	Xtrriage
Refinement program	REFMAC 5.7.0032	Depositor
R, R_{free}	0.377 , 0.387 0.368 , 0.364	Depositor DCC
R_{free} test set	843 reflections (5.10%)	wwPDB-VP
Wilson B-factor (Å ²)	375.9	Xtrriage
Anisotropy	0.537	Xtrriage
Bulk solvent k_{sol} (e/Å ³), B_{sol} (Å ²)	0.34 , 214.2	EDS
L-test for twinning ²	$\langle L \rangle = 0.45$, $\langle L^2 \rangle = 0.27$	Xtrriage
Estimated twinning fraction	0.045 for -h,-k,l	Xtrriage
F_o, F_c correlation	0.78	EDS
Total number of atoms	43995	wwPDB-VP
Average B, all atoms (Å ²)	89.0	wwPDB-VP

Xtrriage's analysis on translational NCS is as follows: *The largest off-origin peak in the Patterson function is 3.16% of the height of the origin peak. No significant pseudotranslation is detected.*

¹Intensities estimated from amplitudes.

²Theoretical values of $\langle |L| \rangle$, $\langle L^2 \rangle$ for acentric reflections are 0.5, 0.333 respectively for untwinned datasets, and 0.375, 0.2 for perfectly twinned datasets.

5 Model quality [i](#)

5.1 Standard geometry [i](#)

Bond lengths and bond angles in the following residue types are not validated in this section: BMA, NAG, MAN

The Z score for a bond length (or angle) is the number of standard deviations the observed value is removed from the expected value. A bond length (or angle) with $|Z| > 5$ is considered an outlier worth inspection. RMSZ is the root-mean-square of all Z scores of the bond lengths (or angles).

Mol	Chain	Bond lengths		Bond angles	
		RMSZ	# Z >5	RMSZ	# Z >5
1	A	0.47	0/2606	0.67	1/3542 (0.0%)
1	C	0.47	0/2596	0.67	1/3527 (0.0%)
1	G	0.47	0/2592	0.67	1/3521 (0.0%)
1	M	0.47	0/2606	0.67	1/3542 (0.0%)
1	O	0.46	0/2577	0.66	0/3503
1	S	0.47	0/2606	0.67	1/3542 (0.0%)
2	B	0.50	0/1418	0.65	0/1906
2	D	0.50	0/1418	0.65	0/1906
2	I	0.49	0/1430	0.65	0/1924
2	N	0.50	0/1384	0.65	0/1857
2	P	0.50	0/1418	0.65	0/1906
2	U	0.50	0/1430	0.65	0/1924
3	E	0.64	0/1707	0.74	0/2313
3	J	0.64	0/1667	0.75	0/2257
3	L	0.65	0/1700	0.74	0/2301
3	Q	0.65	0/1699	0.74	0/2300
3	V	0.64	0/1688	0.74	0/2285
3	X	0.64	0/1707	0.74	0/2313
4	F	0.62	0/1720	0.77	0/2350
4	H	0.62	0/1720	0.77	0/2350
4	K	0.62	0/1718	0.77	0/2345
4	R	0.62	0/1720	0.77	0/2350
4	T	0.61	0/1711	0.77	0/2337
4	W	0.62	0/1720	0.77	0/2350
All	All	0.55	0/44558	0.71	5/60451 (0.0%)

Chiral center outliers are detected by calculating the chiral volume of a chiral center and verifying if the center is modelled as a planar moiety or with the opposite hand. A planarity outlier is detected by checking planarity of atoms in a peptide group, atoms in a mainchain group or atoms of a sidechain that are expected to be planar.

Mol	Chain	#Chirality outliers	#Planarity outliers
3	E	0	1

There are no bond length outliers.

All (5) bond angle outliers are listed below:

Mol	Chain	Res	Type	Atoms	Z	Observed(°)	Ideal(°)
1	A	9	PRO	CA-N-CD	-8.46	99.65	111.50
1	C	9	PRO	CA-N-CD	-8.46	99.66	111.50
1	G	9	PRO	CA-N-CD	-8.46	99.66	111.50
1	M	9	PRO	CA-N-CD	-8.44	99.68	111.50
1	S	9	PRO	CA-N-CD	-8.44	99.68	111.50

There are no chirality outliers.

All (1) planarity outliers are listed below:

Mol	Chain	Res	Type	Group
3	E	50	ARG	Sidechain

5.2 Too-close contacts [i](#)

In the following table, the Non-H and H(model) columns list the number of non-hydrogen atoms and hydrogen atoms in the chain respectively. The H(added) column lists the number of hydrogen atoms added and optimized by MolProbity. The Clashes column lists the number of clashes within the asymmetric unit, whereas Symm-Clashes lists symmetry-related clashes.

Mol	Chain	Non-H	H(model)	H(added)	Clashes	Symm-Clashes
1	A	2542	0	2464	74	0
1	C	2533	0	2455	75	0
1	G	2530	0	2453	68	0
1	M	2542	0	2464	77	0
1	O	2514	0	2440	75	0
1	S	2542	0	2463	73	0
2	B	1393	0	1295	24	0
2	D	1393	0	1295	55	0
2	I	1403	0	1302	36	0
2	N	1363	0	1272	54	0
2	P	1393	0	1294	35	0
2	U	1403	0	1302	46	0
3	E	1672	0	1597	57	0
3	J	1634	0	1560	77	0
3	L	1666	0	1592	70	0

Continued on next page...

Continued from previous page...

Mol	Chain	Non-H	H(model)	H(added)	Clashes	Symm-Clashes
3	Q	1665	0	1589	57	0
3	V	1655	0	1577	76	0
3	X	1672	0	1597	77	0
4	F	1675	0	1626	61	0
4	H	1675	0	1626	75	0
4	K	1674	0	1625	79	0
4	R	1675	0	1626	60	0
4	T	1666	0	1618	79	0
4	W	1675	0	1626	100	0
5	Y	39	0	34	1	0
5	d	39	0	34	0	0
5	f	39	0	34	0	0
6	Z	94	0	79	0	0
7	a	28	0	25	0	0
7	c	28	0	25	0	0
8	b	39	0	34	0	0
9	e	50	0	43	0	0
10	A	14	0	13	0	0
10	C	14	0	13	0	0
10	M	14	0	13	0	0
10	O	14	0	13	0	0
10	P	14	0	13	2	0
10	S	14	0	13	0	0
All	All	43995	0	42144	1200	0

The all-atom clashscore is defined as the number of clashes found per 1000 atoms (including hydrogen atoms). The all-atom clashscore for this structure is 14.

The worst 5 of 1200 close contacts within the same asymmetric unit are listed below, sorted by their clash magnitude.

Atom-1	Atom-2	Interatomic distance (Å)	Clash overlap (Å)
4:H:31:GLU:HG3	4:H:32:TYR:CD1	1.57	1.40
4:K:31:GLU:HG3	4:K:32:TYR:CD1	1.57	1.39
4:W:31:GLU:HG3	4:W:32:TYR:CD1	1.57	1.39
3:V:164:THR:HG23	4:W:174:PHE:CD1	1.59	1.38
4:R:31:GLU:HG3	4:R:32:TYR:CD1	1.57	1.38

There are no symmetry-related clashes.

5.3 Torsion angles [i](#)

5.3.1 Protein backbone [i](#)

In the following table, the Percentiles column shows the percent Ramachandran outliers of the chain as a percentile score with respect to all X-ray entries followed by that with respect to entries of similar resolution.

The Analysed column shows the number of residues for which the backbone conformation was analysed, and the total number of residues.

Mol	Chain	Analysed	Favoured	Allowed	Outliers	Percentiles	
1	A	318/334 (95%)	309 (97%)	9 (3%)	0	100	100
1	C	315/334 (94%)	305 (97%)	10 (3%)	0	100	100
1	G	315/334 (94%)	306 (97%)	9 (3%)	0	100	100
1	M	318/334 (95%)	309 (97%)	9 (3%)	0	100	100
1	O	314/334 (94%)	305 (97%)	9 (3%)	0	100	100
1	S	318/334 (95%)	308 (97%)	10 (3%)	0	100	100
2	B	168/182 (92%)	164 (98%)	4 (2%)	0	100	100
2	D	168/182 (92%)	164 (98%)	4 (2%)	0	100	100
2	I	171/182 (94%)	167 (98%)	4 (2%)	0	100	100
2	N	163/182 (90%)	160 (98%)	3 (2%)	0	100	100
2	P	168/182 (92%)	164 (98%)	4 (2%)	0	100	100
2	U	171/182 (94%)	167 (98%)	4 (2%)	0	100	100
3	E	212/218 (97%)	194 (92%)	18 (8%)	0	100	100
3	J	203/218 (93%)	185 (91%)	18 (9%)	0	100	100
3	L	209/218 (96%)	191 (91%)	18 (9%)	0	100	100
3	Q	209/218 (96%)	191 (91%)	18 (9%)	0	100	100
3	V	206/218 (94%)	189 (92%)	17 (8%)	0	100	100
3	X	212/218 (97%)	194 (92%)	18 (8%)	0	100	100
4	F	217/222 (98%)	187 (86%)	26 (12%)	4 (2%)	8	40
4	H	217/222 (98%)	189 (87%)	24 (11%)	4 (2%)	8	40
4	K	217/222 (98%)	188 (87%)	25 (12%)	4 (2%)	8	40
4	R	217/222 (98%)	189 (87%)	24 (11%)	4 (2%)	8	40
4	T	216/222 (97%)	188 (87%)	25 (12%)	3 (1%)	11	46
4	W	217/222 (98%)	188 (87%)	25 (12%)	4 (2%)	8	40
All	All	5459/5736 (95%)	5101 (93%)	335 (6%)	23 (0%)	34	72

5 of 23 Ramachandran outliers are listed below:

Mol	Chain	Res	Type
4	H	135	ASN
4	F	135	ASN
4	K	135	ASN
4	R	135	ASN
4	W	135	ASN

5.3.2 Protein sidechains [i](#)

In the following table, the Percentiles column shows the percent sidechain outliers of the chain as a percentile score with respect to all X-ray entries followed by that with respect to entries of similar resolution.

The Analysed column shows the number of residues for which the sidechain conformation was analysed, and the total number of residues.

Mol	Chain	Analysed	Rotameric	Outliers	Percentiles
1	A	286/297 (96%)	276 (96%)	10 (4%)	36 59
1	C	285/297 (96%)	274 (96%)	11 (4%)	32 56
1	G	285/297 (96%)	275 (96%)	10 (4%)	36 59
1	M	286/297 (96%)	276 (96%)	10 (4%)	36 59
1	O	283/297 (95%)	273 (96%)	10 (4%)	36 59
1	S	286/297 (96%)	276 (96%)	10 (4%)	36 59
2	B	147/155 (95%)	146 (99%)	1 (1%)	84 90
2	D	147/155 (95%)	146 (99%)	1 (1%)	84 90
2	I	148/155 (96%)	147 (99%)	1 (1%)	84 90
2	N	144/155 (93%)	144 (100%)	0	100 100
2	P	147/155 (95%)	146 (99%)	1 (1%)	84 90
2	U	148/155 (96%)	146 (99%)	2 (1%)	67 80
3	E	189/191 (99%)	172 (91%)	17 (9%)	9 30
3	J	185/191 (97%)	169 (91%)	16 (9%)	10 32
3	L	188/191 (98%)	171 (91%)	17 (9%)	9 30
3	Q	188/191 (98%)	172 (92%)	16 (8%)	10 33
3	V	187/191 (98%)	170 (91%)	17 (9%)	9 29
3	X	189/191 (99%)	172 (91%)	17 (9%)	9 30
4	F	192/193 (100%)	176 (92%)	16 (8%)	11 34

Continued on next page...

Continued from previous page...

Mol	Chain	Analysed	Rotameric	Outliers	Percentiles	
4	H	192/193 (100%)	176 (92%)	16 (8%)	11	34
4	K	192/193 (100%)	176 (92%)	16 (8%)	11	34
4	R	192/193 (100%)	176 (92%)	16 (8%)	11	34
4	T	191/193 (99%)	174 (91%)	17 (9%)	9	30
4	W	192/193 (100%)	175 (91%)	17 (9%)	9	30
All	All	4869/5016 (97%)	4604 (95%)	265 (5%)	22	47

5 of 265 residues with a non-rotameric sidechain are listed below:

Mol	Chain	Res	Type
4	T	229	ASP
4	R	30	THR
4	W	190	SER
3	E	202	THR
3	E	157	ASN

Sometimes sidechains can be flipped to improve hydrogen bonding and reduce clashes. 5 of 17 such sidechains are listed below:

Mol	Chain	Res	Type
4	R	95	ASN
4	W	95	ASN
1	S	211	GLN
3	V	38	GLN
4	H	95	ASN

5.3.3 RNA [i](#)

There are no RNA molecules in this entry.

5.4 Non-standard residues in protein, DNA, RNA chains [i](#)

There are no non-standard protein/DNA/RNA residues in this entry.

5.5 Carbohydrates [i](#)

28 monosaccharides are modelled in this entry.

In the following table, the Counts columns list the number of bonds (or angles) for which Mogul statistics could be retrieved, the number of bonds (or angles) that are observed in the model and the number of bonds (or angles) that are defined in the Chemical Component Dictionary. The Link column lists molecule types, if any, to which the group is linked. The Z score for a bond length (or angle) is the number of standard deviations the observed value is removed from the expected value. A bond length (or angle) with $|Z| > 2$ is considered an outlier worth inspection. RMSZ is the root-mean-square of all Z scores of the bond lengths (or angles).

Mol	Type	Chain	Res	Link	Bond lengths			Bond angles		
					Counts	RMSZ	# Z > 2	Counts	RMSZ	# Z > 2
5	NAG	Y	1	5,1	14,14,15	1.31	2 (14%)	17,19,21	2.07	5 (29%)
5	NAG	Y	2	5	14,14,15	1.85	4 (28%)	17,19,21	1.57	3 (17%)
5	MAN	Y	3	5	11,11,12	1.97	4 (36%)	15,15,17	2.01	5 (33%)
6	NAG	Z	1	6,1	14,14,15	0.49	0	17,19,21	2.23	3 (17%)
6	NAG	Z	2	6	14,14,15	0.51	0	17,19,21	1.39	3 (17%)
6	BMA	Z	3	6	11,11,12	0.64	0	15,15,17	1.47	3 (20%)
6	MAN	Z	4	6	11,11,12	0.61	0	15,15,17	2.54	4 (26%)
6	MAN	Z	5	6	11,11,12	0.59	0	15,15,17	2.03	6 (40%)
6	MAN	Z	6	6	11,11,12	0.60	0	15,15,17	2.02	6 (40%)
6	MAN	Z	7	6	11,11,12	0.60	0	15,15,17	2.43	7 (46%)
6	MAN	Z	8	6	11,11,12	0.62	0	15,15,17	2.42	6 (40%)
7	NAG	a	1	1,7	14,14,15	1.39	3 (21%)	17,19,21	2.00	4 (23%)
7	NAG	a	2	7	14,14,15	1.72	4 (28%)	17,19,21	1.79	6 (35%)
8	NAG	b	1	1,8	14,14,15	0.55	0	17,19,21	1.29	3 (17%)
8	NAG	b	2	8	14,14,15	0.45	0	17,19,21	0.70	0
8	BMA	b	3	8	11,11,12	0.63	0	15,15,17	0.68	0
7	NAG	c	1	1,7	14,14,15	1.30	2 (14%)	17,19,21	2.07	5 (29%)
7	NAG	c	2	7	14,14,15	1.84	4 (28%)	17,19,21	1.57	2 (11%)
5	NAG	d	1	5,1	14,14,15	1.27	2 (14%)	17,19,21	1.84	4 (23%)
5	NAG	d	2	5	14,14,15	1.81	4 (28%)	17,19,21	1.76	6 (35%)
5	MAN	d	3	5	11,11,12	1.86	3 (27%)	15,15,17	2.03	4 (26%)
9	NAG	e	1	9,1	14,14,15	0.59	0	17,19,21	1.25	2 (11%)
9	NAG	e	2	9	14,14,15	0.48	0	17,19,21	1.14	1 (5%)
9	BMA	e	3	9	11,11,12	0.75	0	15,15,17	0.65	0
9	MAN	e	4	9	11,11,12	0.61	0	15,15,17	1.06	1 (6%)
5	NAG	f	1	5,1	14,14,15	1.39	3 (21%)	17,19,21	2.01	4 (23%)
5	NAG	f	2	5	14,14,15	1.73	4 (28%)	17,19,21	1.80	6 (35%)
5	MAN	f	3	5	11,11,12	1.83	3 (27%)	15,15,17	2.08	5 (33%)

In the following table, the Chirals column lists the number of chiral outliers, the number of chiral centers analysed, the number of these observed in the model and the number defined in the Chemical Component Dictionary. Similar counts are reported in the Torsion and Rings columns. '-' means no outliers of that kind were identified.

Mol	Type	Chain	Res	Link	Chirals	Torsions	Rings
5	NAG	Y	1	5,1	-	1/6/23/26	0/1/1/1
5	NAG	Y	2	5	-	0/6/23/26	0/1/1/1
5	MAN	Y	3	5	-	2/2/19/22	0/1/1/1
6	NAG	Z	1	6,1	-	1/6/23/26	0/1/1/1
6	NAG	Z	2	6	-	0/6/23/26	0/1/1/1
6	BMA	Z	3	6	-	2/2/19/22	0/1/1/1
6	MAN	Z	4	6	-	0/2/19/22	0/1/1/1
6	MAN	Z	5	6	-	0/2/19/22	0/1/1/1
6	MAN	Z	6	6	-	0/2/19/22	0/1/1/1
6	MAN	Z	7	6	-	0/2/19/22	0/1/1/1
6	MAN	Z	8	6	-	0/2/19/22	0/1/1/1
7	NAG	a	1	1,7	-	1/6/23/26	0/1/1/1
7	NAG	a	2	7	-	0/6/23/26	0/1/1/1
8	NAG	b	1	1,8	-	0/6/23/26	0/1/1/1
8	NAG	b	2	8	-	0/6/23/26	0/1/1/1
8	BMA	b	3	8	-	1/2/19/22	0/1/1/1
7	NAG	c	1	1,7	-	1/6/23/26	0/1/1/1
7	NAG	c	2	7	-	0/6/23/26	0/1/1/1
5	NAG	d	1	5,1	-	1/6/23/26	0/1/1/1
5	NAG	d	2	5	-	0/6/23/26	0/1/1/1
5	MAN	d	3	5	-	2/2/19/22	0/1/1/1
9	NAG	e	1	9,1	-	0/6/23/26	0/1/1/1
9	NAG	e	2	9	-	0/6/23/26	0/1/1/1
9	BMA	e	3	9	-	0/2/19/22	0/1/1/1
9	MAN	e	4	9	-	0/2/19/22	0/1/1/1
5	NAG	f	1	5,1	-	1/6/23/26	0/1/1/1
5	NAG	f	2	5	-	0/6/23/26	0/1/1/1
5	MAN	f	3	5	-	2/2/19/22	0/1/1/1

The worst 5 of 42 bond length outliers are listed below:

Mol	Chain	Res	Type	Atoms	Z	Observed(Å)	Ideal(Å)
5	Y	2	NAG	C1-C2	3.53	1.57	1.52
7	c	2	NAG	C1-C2	3.44	1.57	1.52
7	a	2	NAG	C1-C2	3.42	1.57	1.52
5	f	2	NAG	C1-C2	3.38	1.57	1.52
5	d	2	NAG	O4-C4	3.12	1.50	1.43

The worst 5 of 104 bond angle outliers are listed below:

Mol	Chain	Res	Type	Atoms	Z	Observed(°)	Ideal(°)
6	Z	1	NAG	O5-C1-C2	-7.36	99.67	111.29
6	Z	4	MAN	C1-C2-C3	6.99	118.25	109.67
6	Z	8	MAN	C1-O5-C5	5.78	120.02	112.19
7	c	1	NAG	C1-O5-C5	5.10	119.10	112.19
5	Y	1	NAG	C1-O5-C5	5.08	119.07	112.19

There are no chirality outliers.

5 of 15 torsion outliers are listed below:

Mol	Chain	Res	Type	Atoms
5	d	3	MAN	C4-C5-C6-O6
5	Y	3	MAN	C4-C5-C6-O6
5	f	3	MAN	C4-C5-C6-O6
5	d	3	MAN	O5-C5-C6-O6
5	f	3	MAN	O5-C5-C6-O6

There are no ring outliers.

2 monomers are involved in 1 short contact:

Mol	Chain	Res	Type	Clashes	Symm-Clashes
5	Y	2	NAG	1	0
5	Y	1	NAG	1	0

The following is a two-dimensional graphical depiction of Mogul quality analysis of bond lengths, bond angles, torsion angles, and ring geometry for oligosaccharide.

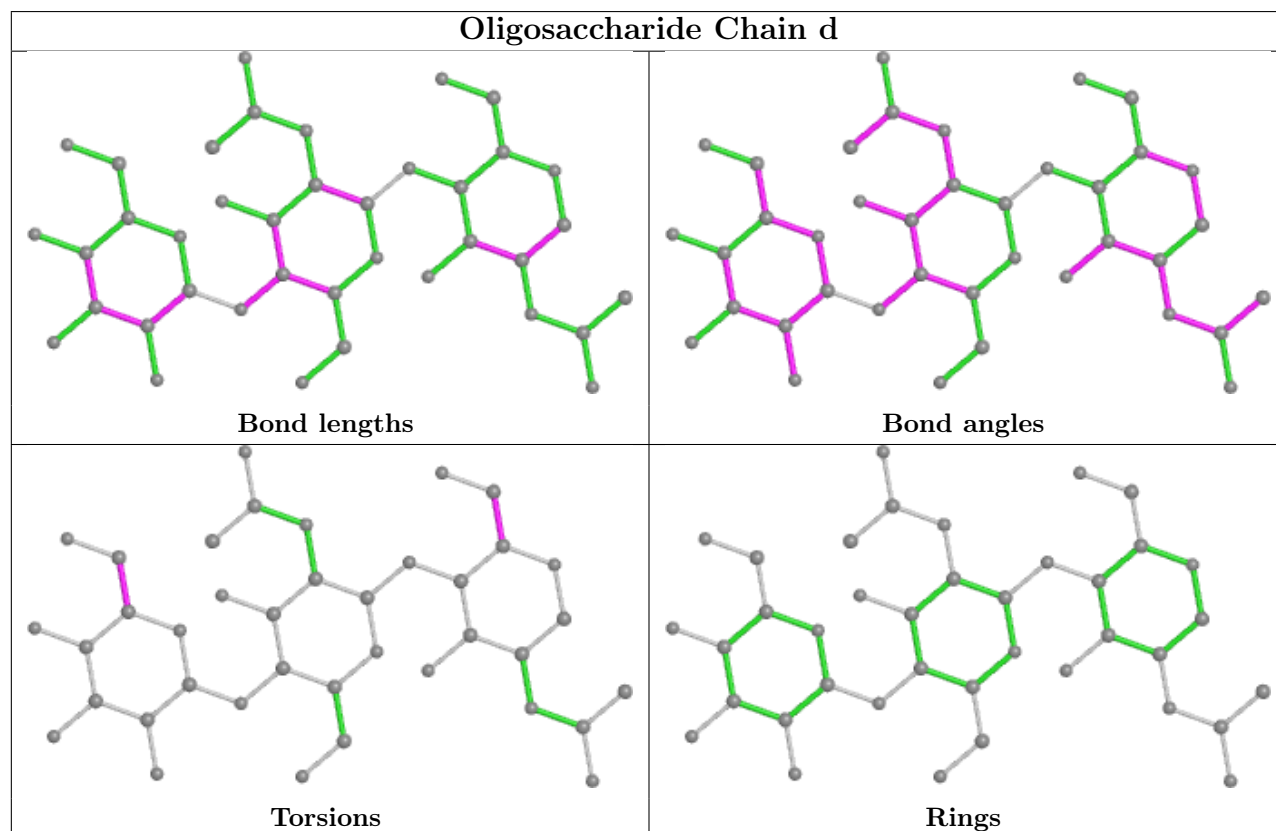
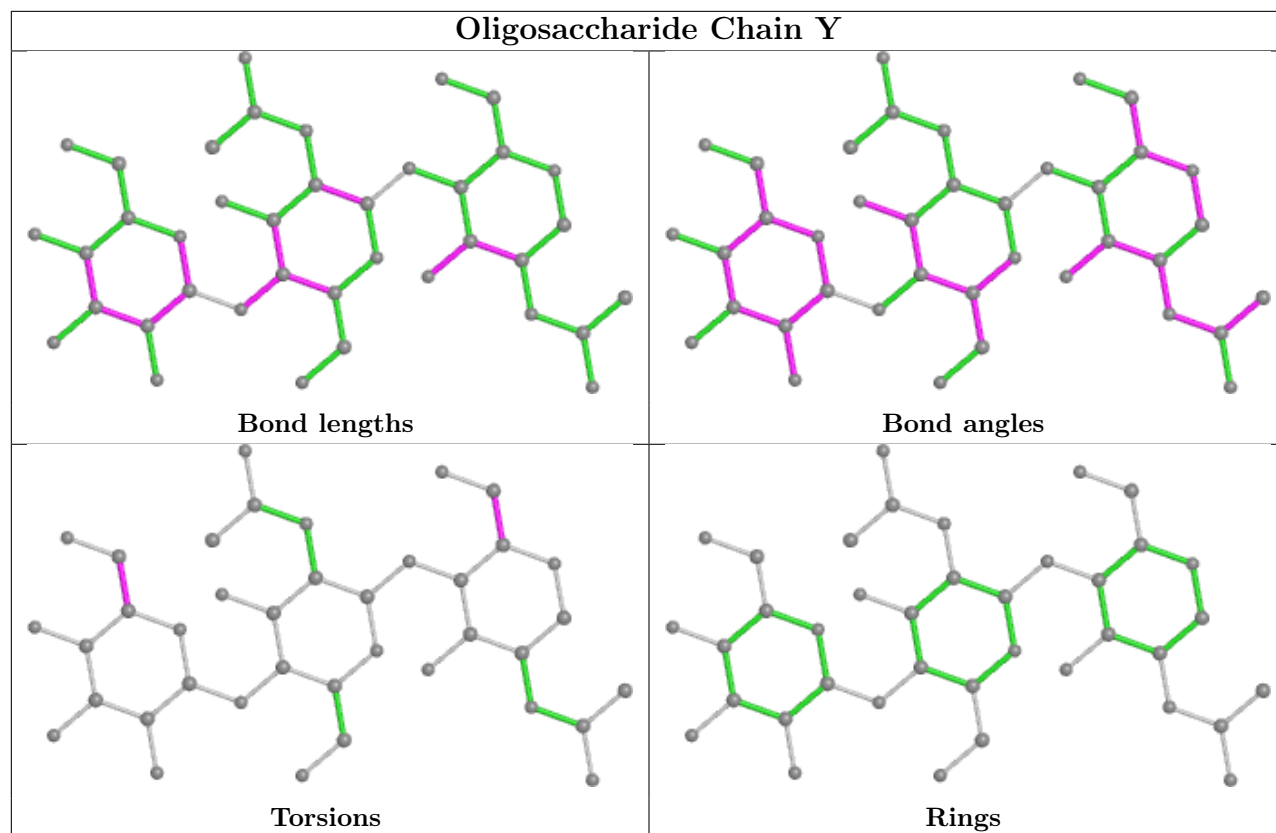

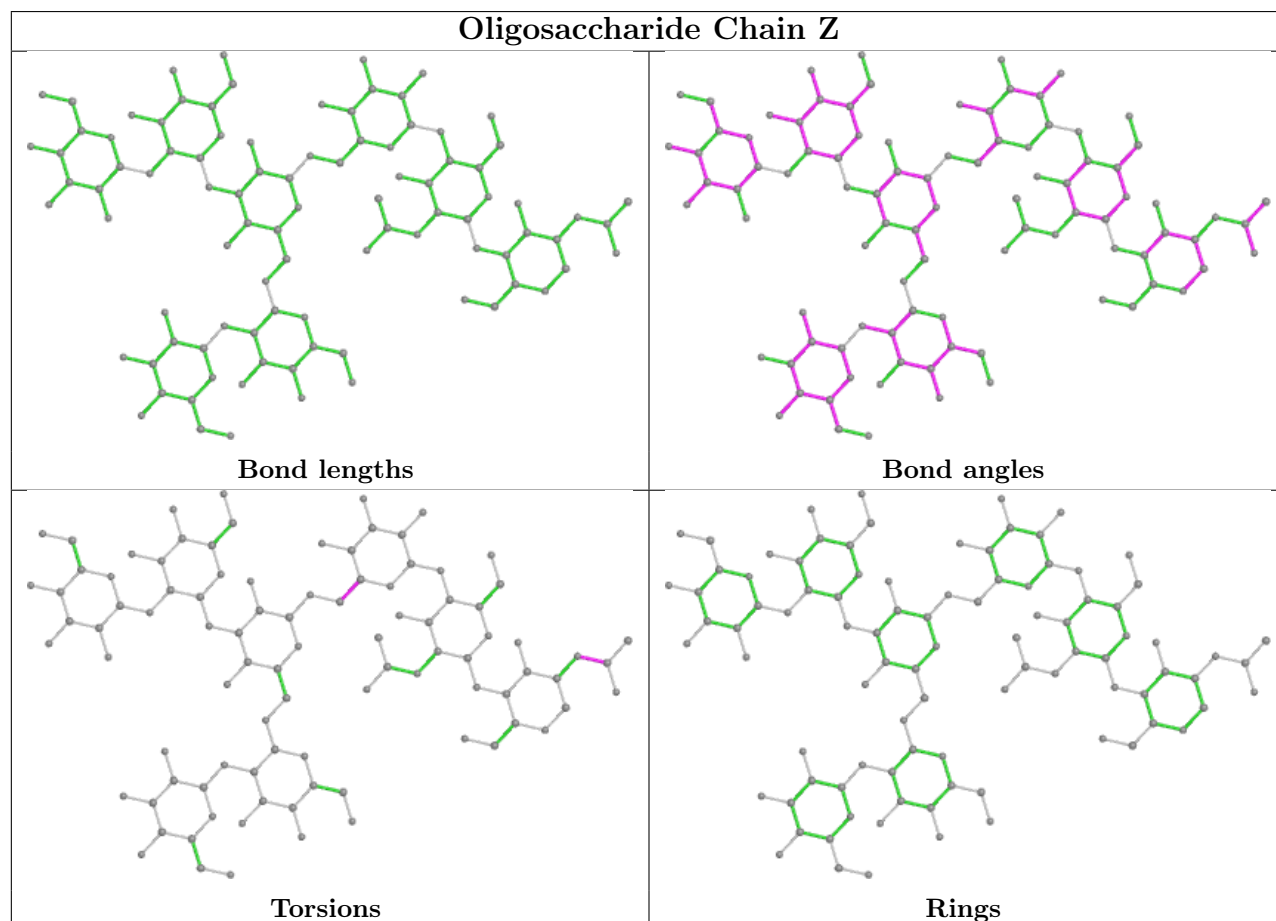
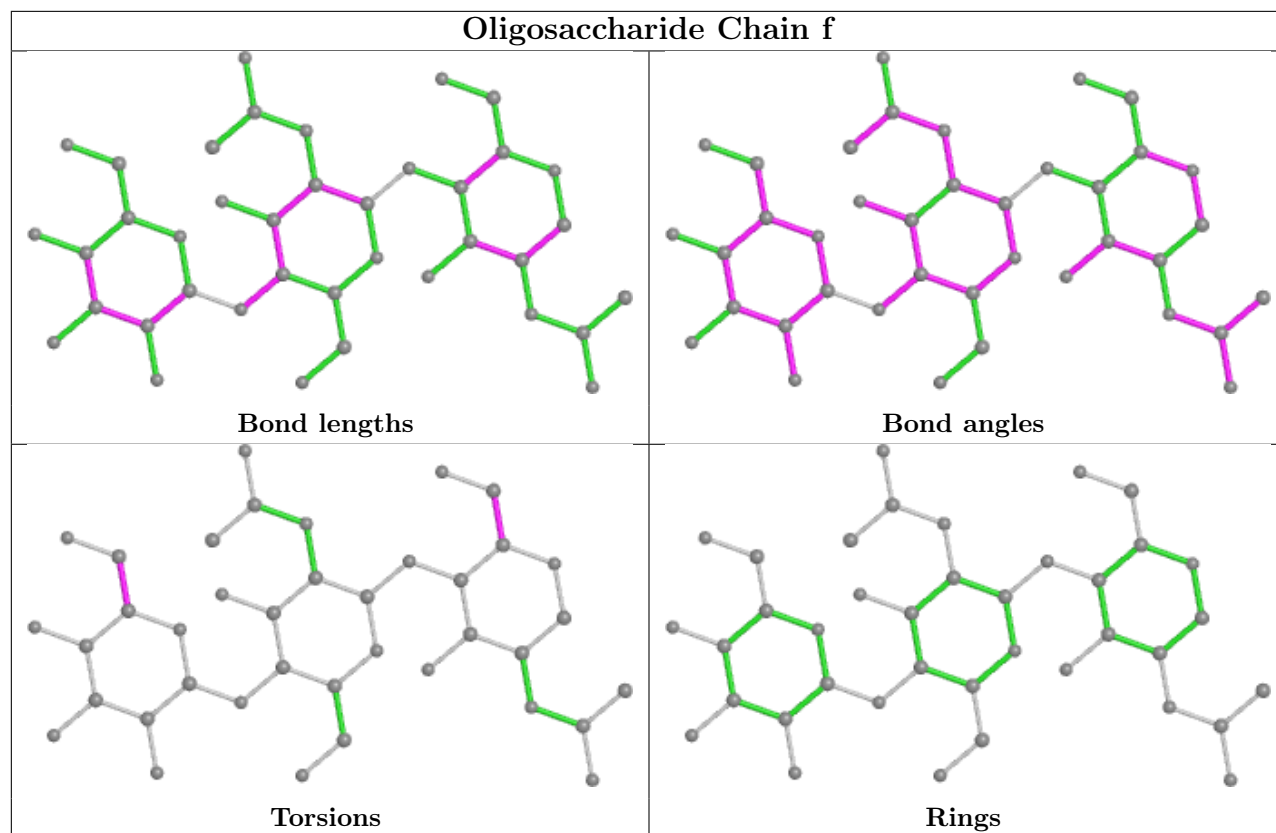

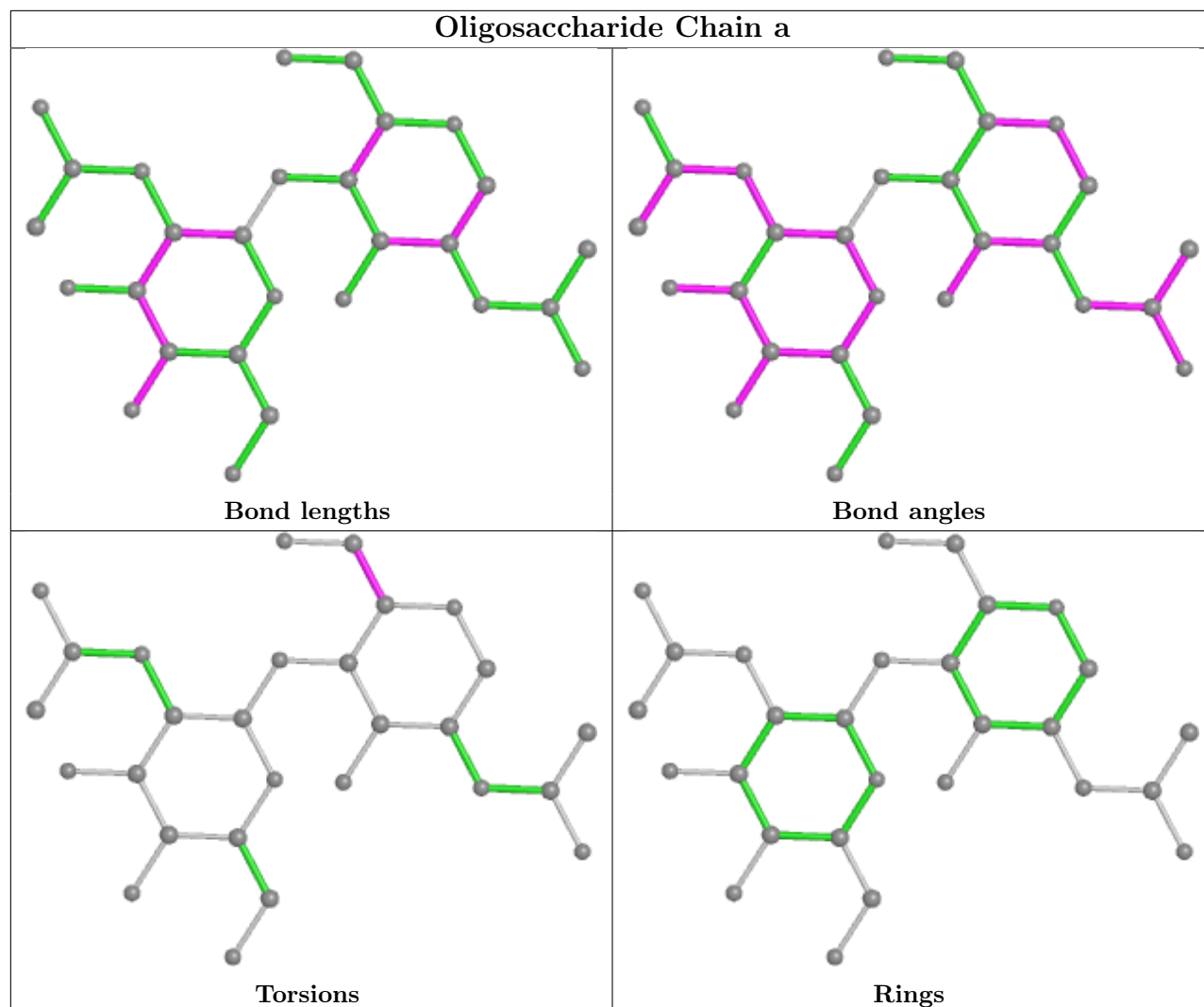

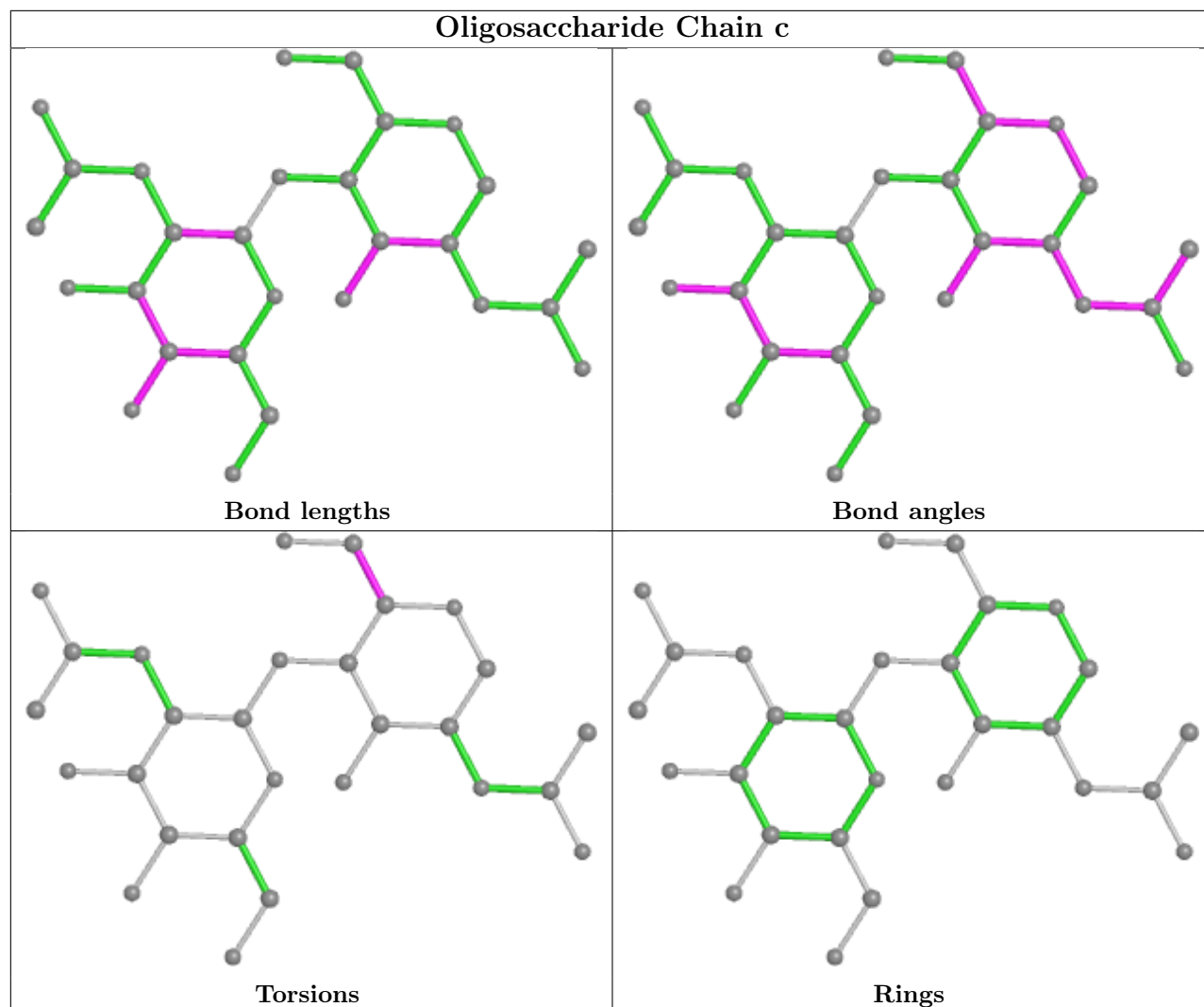

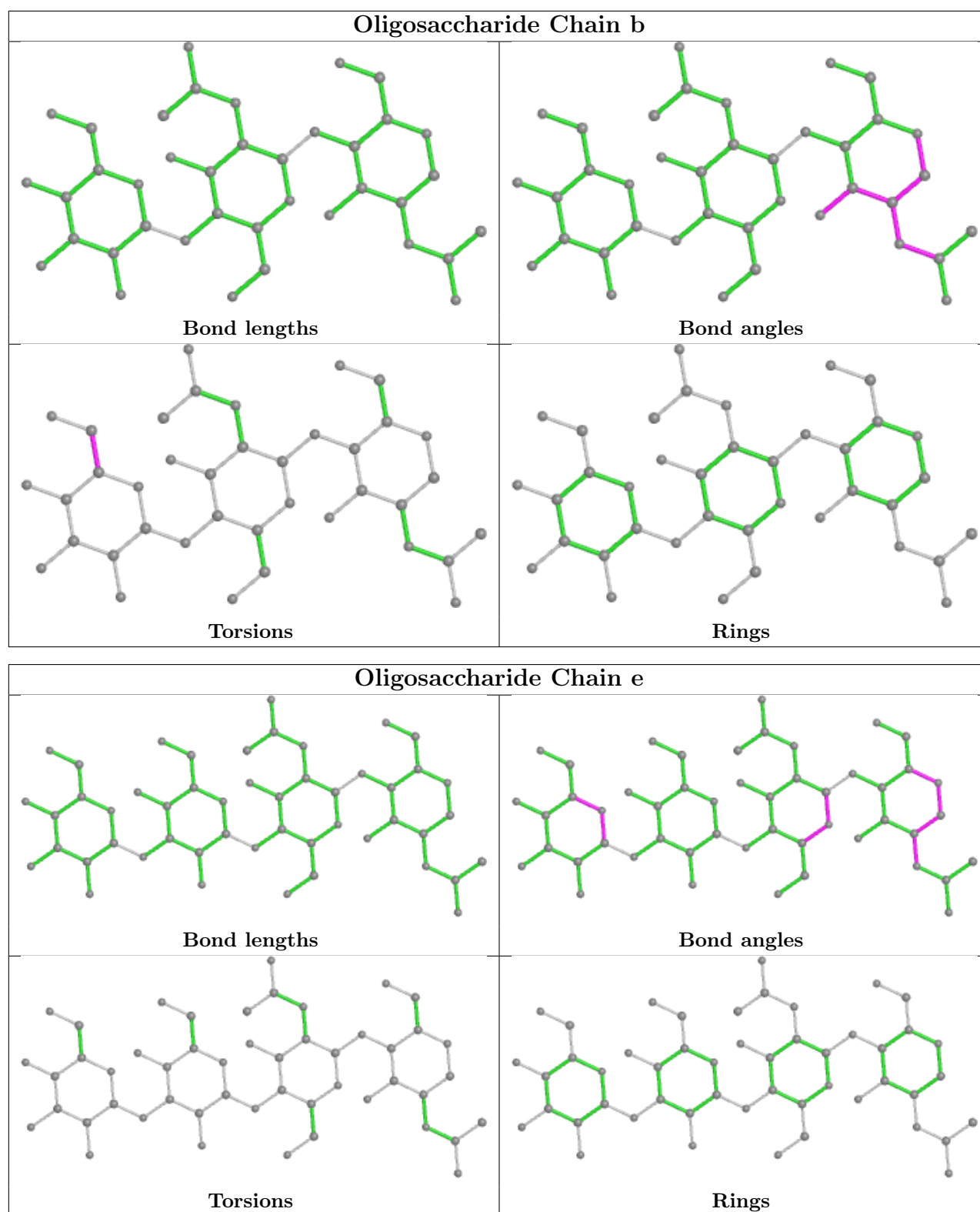

5.6 Ligand geometry [i](#)

6 ligands are modelled in this entry.

In the following table, the Counts columns list the number of bonds (or angles) for which Mogul

statistics could be retrieved, the number of bonds (or angles) that are observed in the model and the number of bonds (or angles) that are defined in the Chemical Component Dictionary. The Link column lists molecule types, if any, to which the group is linked. The Z score for a bond length (or angle) is the number of standard deviations the observed value is removed from the expected value. A bond length (or angle) with $|Z| > 2$ is considered an outlier worth inspection. RMSZ is the root-mean-square of all Z scores of the bond lengths (or angles).

Mol	Type	Chain	Res	Link	Bond lengths			Bond angles		
					Counts	RMSZ	# Z > 2	Counts	RMSZ	# Z > 2
10	NAG	S	2004	1	14,14,15	1.85	4 (28%)	17,19,21	2.62	8 (47%)
10	NAG	M	2003	1	14,14,15	1.93	4 (28%)	17,19,21	2.57	9 (52%)
10	NAG	C	2001	1	14,14,15	1.28	2 (14%)	17,19,21	1.84	4 (23%)
10	NAG	P	2001	2	14,14,15	2.18	5 (35%)	17,19,21	2.69	8 (47%)
10	NAG	A	2004	1	14,14,15	1.94	4 (28%)	17,19,21	2.58	9 (52%)
10	NAG	O	2004	1	14,14,15	1.88	4 (28%)	17,19,21	2.60	8 (47%)

In the following table, the Chirals column lists the number of chiral outliers, the number of chiral centers analysed, the number of these observed in the model and the number defined in the Chemical Component Dictionary. Similar counts are reported in the Torsion and Rings columns. '-' means no outliers of that kind were identified.

Mol	Type	Chain	Res	Link	Chirals	Torsions	Rings
10	NAG	S	2004	1	-	1/6/23/26	0/1/1/1
10	NAG	M	2003	1	-	1/6/23/26	0/1/1/1
10	NAG	C	2001	1	-	1/6/23/26	0/1/1/1
10	NAG	P	2001	2	-	2/6/23/26	0/1/1/1
10	NAG	A	2004	1	-	1/6/23/26	0/1/1/1
10	NAG	O	2004	1	-	1/6/23/26	0/1/1/1

The worst 5 of 23 bond length outliers are listed below:

Mol	Chain	Res	Type	Atoms	Z	Observed(Å)	Ideal(Å)
10	P	2001	NAG	C1-C2	4.32	1.58	1.52
10	A	2004	NAG	C1-C2	3.56	1.57	1.52
10	O	2004	NAG	C1-C2	3.55	1.57	1.52
10	M	2003	NAG	C1-C2	3.53	1.57	1.52
10	P	2001	NAG	C2-N2	3.30	1.51	1.46

The worst 5 of 46 bond angle outliers are listed below:

Mol	Chain	Res	Type	Atoms	Z	Observed(°)	Ideal(°)
10	P	2001	NAG	C2-N2-C7	8.06	134.38	122.90
10	O	2004	NAG	C1-C2-N2	5.69	120.21	110.49

Continued on next page...

Continued from previous page...

Mol	Chain	Res	Type	Atoms	Z	Observed(°)	Ideal(°)
10	S	2004	NAG	C4-C3-C2	5.62	119.26	111.02
10	A	2004	NAG	C1-C2-N2	5.08	119.16	110.49
10	M	2003	NAG	C1-C2-N2	5.04	119.11	110.49

There are no chirality outliers.

5 of 7 torsion outliers are listed below:

Mol	Chain	Res	Type	Atoms
10	S	2004	NAG	O5-C5-C6-O6
10	O	2004	NAG	O5-C5-C6-O6
10	A	2004	NAG	O5-C5-C6-O6
10	M	2003	NAG	O5-C5-C6-O6
10	C	2001	NAG	C4-C5-C6-O6

There are no ring outliers.

1 monomer is involved in 2 short contacts:

Mol	Chain	Res	Type	Clashes	Symm-Clashes
10	P	2001	NAG	2	0

5.7 Other polymers [i](#)

There are no such residues in this entry.

5.8 Polymer linkage issues [i](#)

There are no chain breaks in this entry.

6 Fit of model and data [i](#)

6.1 Protein, DNA and RNA chains [i](#)

In the following table, the column labelled '#RSRZ > 2' contains the number (and percentage) of RSRZ outliers, followed by percent RSRZ outliers for the chain as percentile scores relative to all X-ray entries and entries of similar resolution. The OWAB column contains the minimum, median, 95th percentile and maximum values of the occupancy-weighted average B-factor per residue. The column labelled 'Q < 0.9' lists the number of (and percentage) of residues with an average occupancy less than 0.9.

Mol	Chain	Analysed	<RSRZ>	#RSRZ>2	OWAB(Å ²)	Q<0.9
1	A	322/334 (96%)	0.71	30 (9%) 8 11	60, 90, 90, 90	0
1	C	321/334 (96%)	0.84	44 (13%) 3 6	60, 90, 90, 90	0
1	G	321/334 (96%)	0.80	38 (11%) 4 8	60, 90, 90, 90	0
1	M	322/334 (96%)	0.71	32 (9%) 7 10	60, 90, 90, 90	0
1	O	318/334 (95%)	0.90	47 (14%) 2 5	90, 90, 90, 90	0
1	S	322/334 (96%)	0.69	37 (11%) 4 9	60, 90, 90, 90	0
2	B	172/182 (94%)	0.36	10 (5%) 23 23	90, 90, 90, 90	0
2	D	172/182 (94%)	0.49	13 (7%) 13 15	90, 90, 90, 90	0
2	I	173/182 (95%)	0.97	21 (12%) 4 8	90, 90, 90, 90	0
2	N	169/182 (92%)	0.57	14 (8%) 11 13	90, 90, 90, 90	0
2	P	172/182 (94%)	0.49	7 (4%) 37 34	90, 90, 90, 90	0
2	U	173/182 (95%)	0.29	5 (2%) 51 44	90, 90, 90, 90	0
3	E	216/218 (99%)	1.17	44 (20%) 1 3	90, 90, 90, 90	0
3	J	211/218 (96%)	1.02	32 (15%) 2 5	90, 90, 90, 90	0
3	L	215/218 (98%)	0.68	23 (10%) 6 9	90, 90, 90, 90	0
3	Q	215/218 (98%)	0.80	27 (12%) 3 8	90, 90, 90, 90	0
3	V	214/218 (98%)	1.22	54 (25%) 0 2	90, 90, 90, 90	0
3	X	216/218 (99%)	0.62	13 (6%) 21 21	90, 90, 90, 90	0
4	F	221/222 (99%)	0.95	43 (19%) 1 3	90, 90, 90, 90	1 (0%)
4	H	221/222 (99%)	1.36	61 (27%) 0 2	90, 90, 90, 90	1 (0%)
4	K	221/222 (99%)	1.17	43 (19%) 1 3	90, 90, 90, 90	1 (0%)
4	R	221/222 (99%)	1.00	41 (18%) 1 4	90, 90, 90, 90	1 (0%)
4	T	220/222 (99%)	0.99	37 (16%) 1 4	90, 90, 90, 90	1 (0%)
4	W	221/222 (99%)	1.37	54 (24%) 0 2	90, 90, 90, 90	1 (0%)

Continued on next page...

Continued from previous page...

Mol	Chain	Analysed	<RSRZ>	#RSRZ>2	OWAB(Å ²)	Q<0.9
All	All	5569/5736 (97%)	0.85	770 (13%) 2 6	60, 90, 90, 90	6 (0%)

The worst 5 of 770 RSRZ outliers are listed below:

Mol	Chain	Res	Type	RSRZ
4	W	130	ALA	14.6
3	E	157	ASN	10.0
1	C	273	GLU	8.7
4	W	129	ALA	8.2
4	W	123	PRO	8.2

6.2 Non-standard residues in protein, DNA, RNA chains [i](#)

There are no non-standard protein/DNA/RNA residues in this entry.

6.3 Carbohydrates [i](#)

In the following table, the Atoms column lists the number of modelled atoms in the group and the number defined in the chemical component dictionary. The B-factors column lists the minimum, median, 95th percentile and maximum values of B factors of atoms in the group. The column labelled 'Q< 0.9' lists the number of atoms with occupancy less than 0.9.

Mol	Type	Chain	Res	Atoms	RSCC	RSR	B-factors(Å ²)	Q<0.9
5	MAN	Y	3	11/12	0.49	0.51	90,90,90,90	0
9	MAN	e	4	11/12	0.56	0.41	47,49,50,52	0
8	BMA	b	3	11/12	0.57	0.40	102,115,122,126	0
9	NAG	e	1	14/15	0.57	0.45	32,37,44,45	0
5	MAN	d	3	11/12	0.57	0.41	90,90,90,90	0
6	MAN	Z	6	11/12	0.59	0.28	90,90,90,90	0
5	MAN	f	3	11/12	0.66	0.23	90,90,90,90	0
6	NAG	Z	1	14/15	0.66	0.38	90,90,90,90	0
5	NAG	Y	2	14/15	0.66	0.51	90,90,90,90	0
5	NAG	f	1	14/15	0.68	0.33	90,90,90,90	0
7	NAG	a	2	14/15	0.69	0.31	90,90,90,90	0
5	NAG	d	2	14/15	0.69	0.40	90,90,90,90	0
8	NAG	b	2	14/15	0.70	0.40	48,62,76,87	0
9	BMA	e	3	11/12	0.71	0.37	43,47,56,63	0
7	NAG	c	2	14/15	0.76	0.40	90,90,90,90	0
7	NAG	a	1	14/15	0.76	0.23	90,90,90,90	0
5	NAG	f	2	14/15	0.77	0.25	90,90,90,90	0

Continued on next page...

Continued from previous page...

Mol	Type	Chain	Res	Atoms	RSCC	RSR	B-factors(\AA^2)	Q<0.9
6	NAG	Z	2	14/15	0.77	0.32	90,90,90,90	0
6	MAN	Z	5	11/12	0.77	0.48	90,90,90,90	0
5	NAG	d	1	14/15	0.77	0.44	90,90,90,90	0
6	MAN	Z	8	11/12	0.78	0.32	90,90,90,90	0
5	NAG	Y	1	14/15	0.80	0.42	90,90,90,90	0
7	NAG	c	1	14/15	0.80	0.48	90,90,90,90	0
6	MAN	Z	4	11/12	0.83	0.31	90,90,90,90	0
9	NAG	e	2	14/15	0.83	0.41	37,38,39,42	0
6	BMA	Z	3	11/12	0.84	0.35	90,90,90,90	0
8	NAG	b	1	14/15	0.88	0.25	38,47,53,63	0
6	MAN	Z	7	11/12	0.91	0.35	90,90,90,90	0

The following is a graphical depiction of the model fit to experimental electron density for oligosaccharide. Each fit is shown from different orientation to approximate a three-dimensional view.

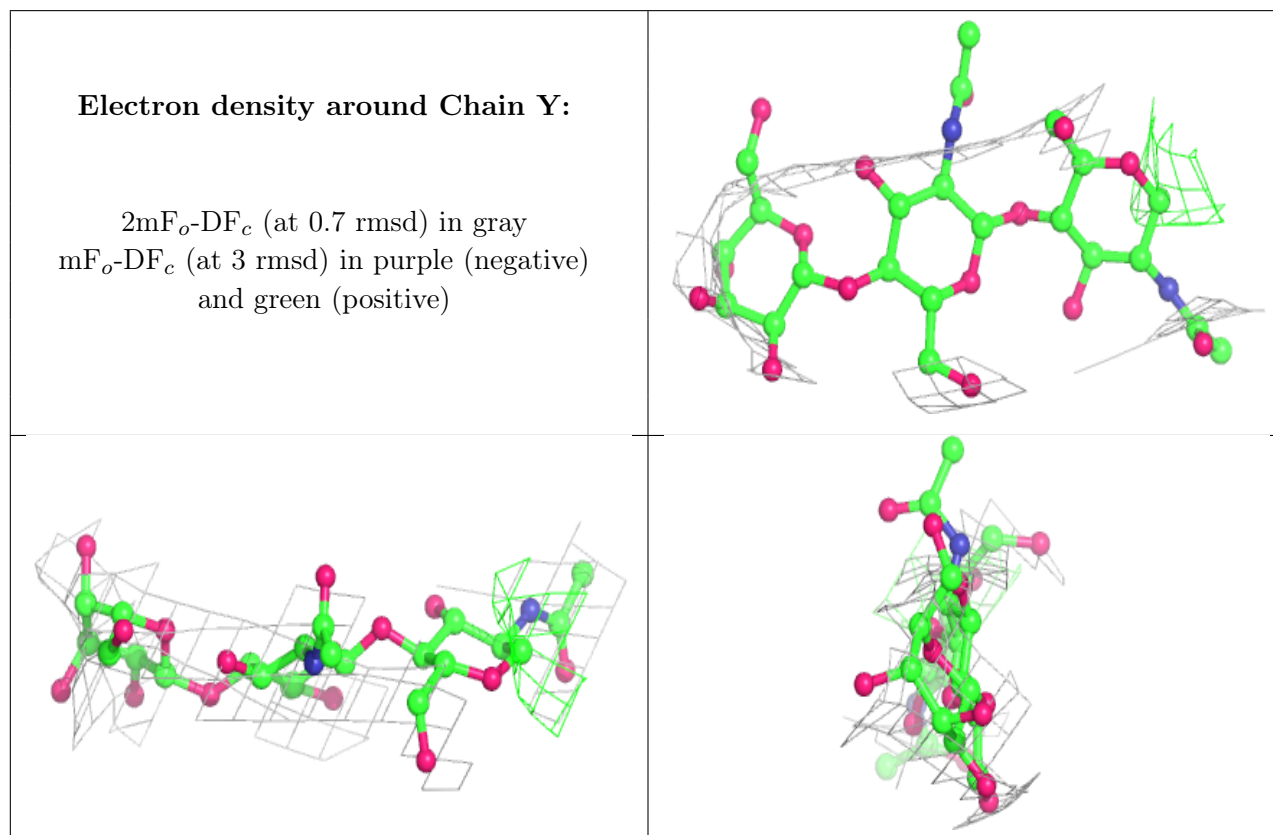

Electron density around Chain d:

$2mF_o-DF_c$ (at 0.7 rmsd) in gray
 mF_o-DF_c (at 3 rmsd) in purple (negative)
and green (positive)

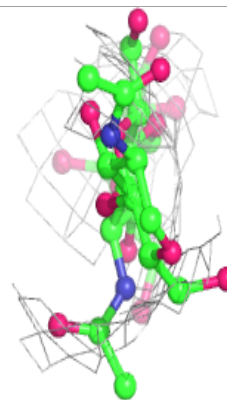
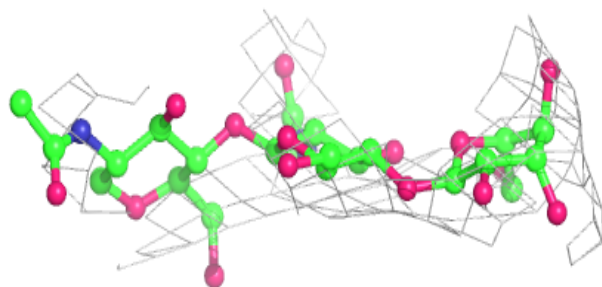
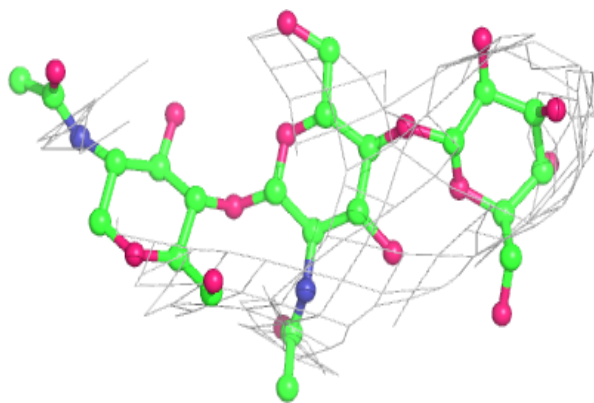
**Electron density around Chain f:**

$2mF_o-DF_c$ (at 0.7 rmsd) in gray
 mF_o-DF_c (at 3 rmsd) in purple (negative)
and green (positive)

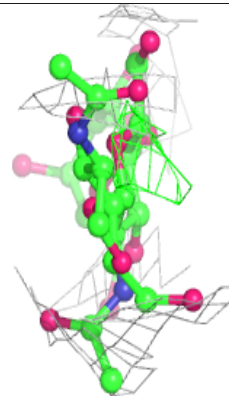
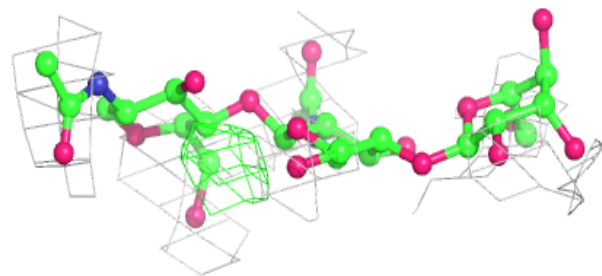
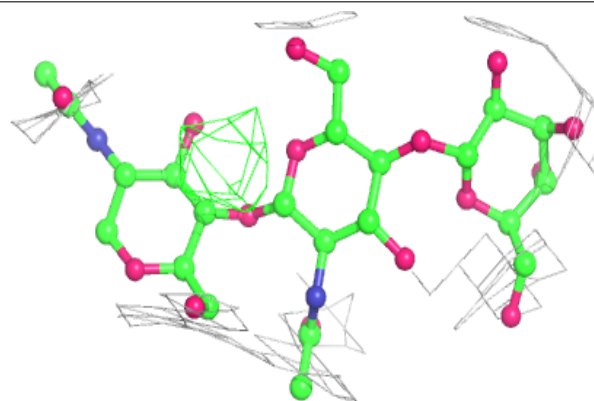

Electron density around Chain Z:

$2mF_o-DF_c$ (at 0.7 rmsd) in gray
 mF_o-DF_c (at 3 rmsd) in purple (negative)
and green (positive)

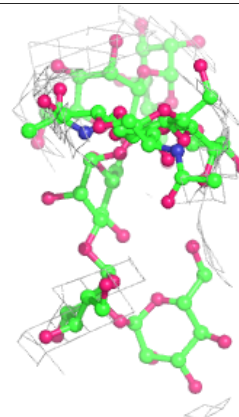
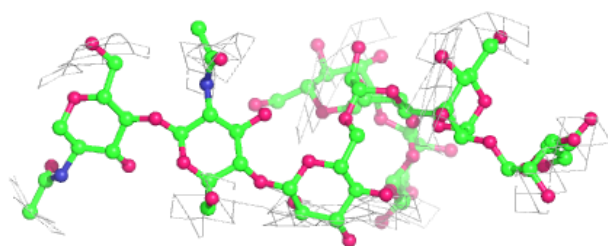
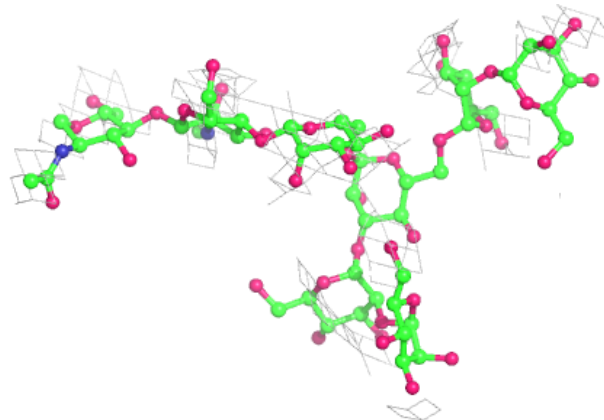
**Electron density around Chain a:**

$2mF_o-DF_c$ (at 0.7 rmsd) in gray
 mF_o-DF_c (at 3 rmsd) in purple (negative)
and green (positive)

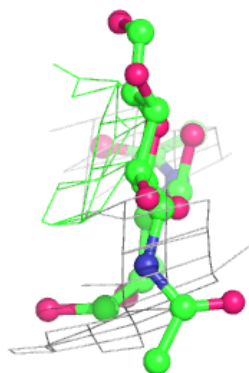
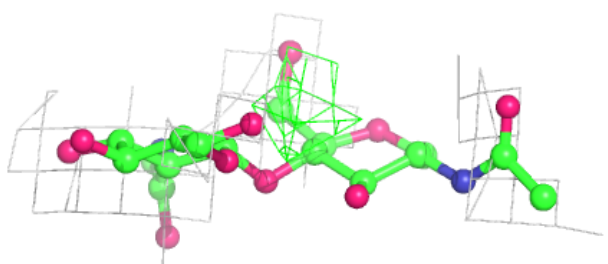
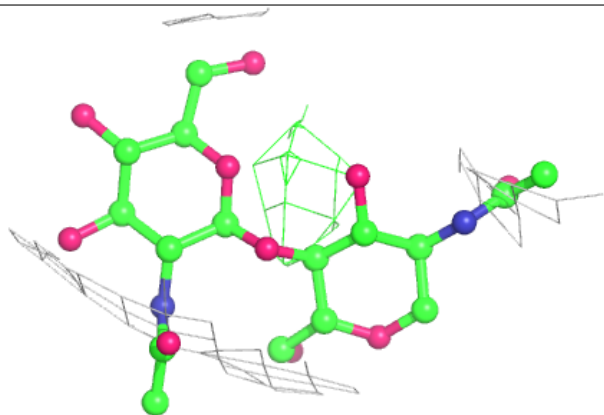

Electron density around Chain c:

$2mF_o-DF_c$ (at 0.7 rmsd) in gray
 mF_o-DF_c (at 3 rmsd) in purple (negative)
and green (positive)

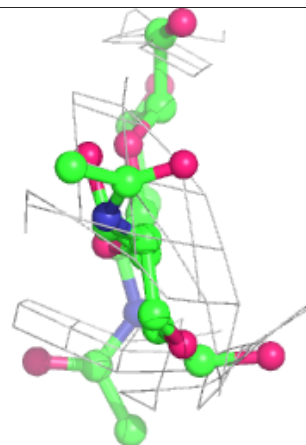
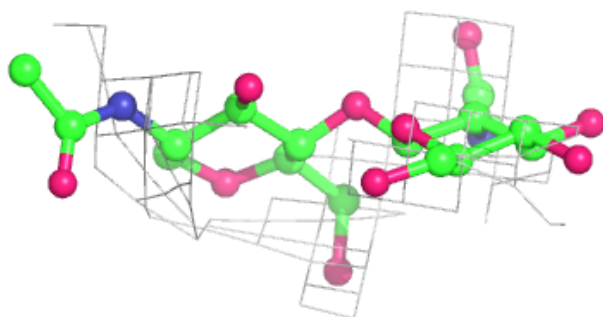
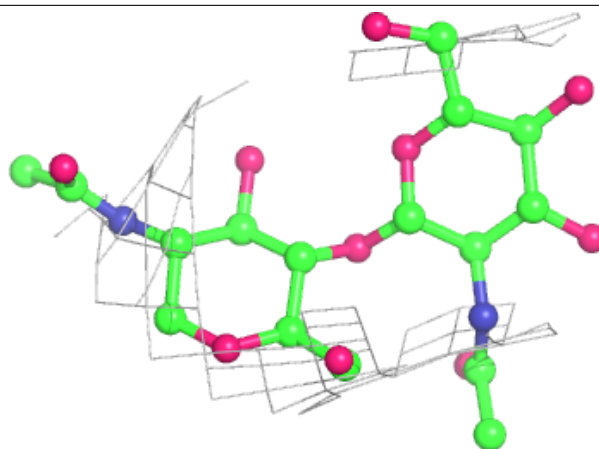
**Electron density around Chain b:**

$2mF_o-DF_c$ (at 0.7 rmsd) in gray
 mF_o-DF_c (at 3 rmsd) in purple (negative)
and green (positive)

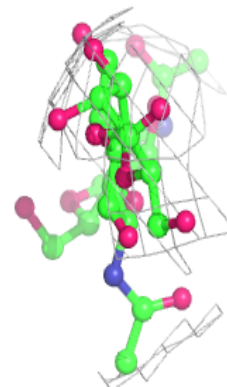
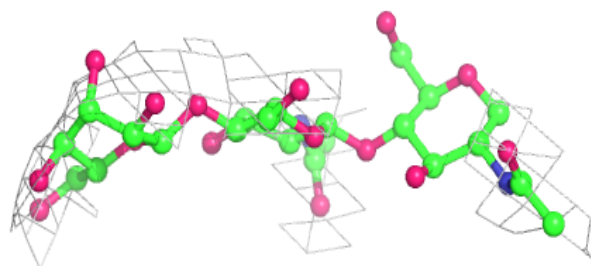
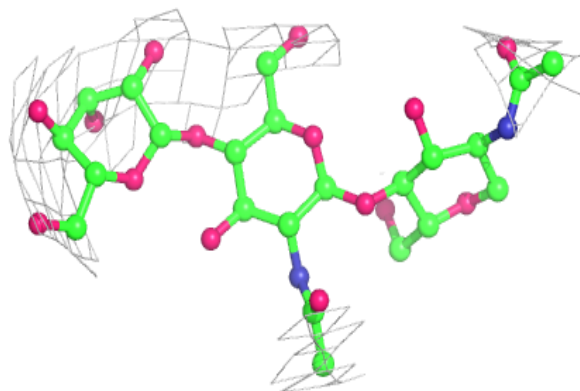

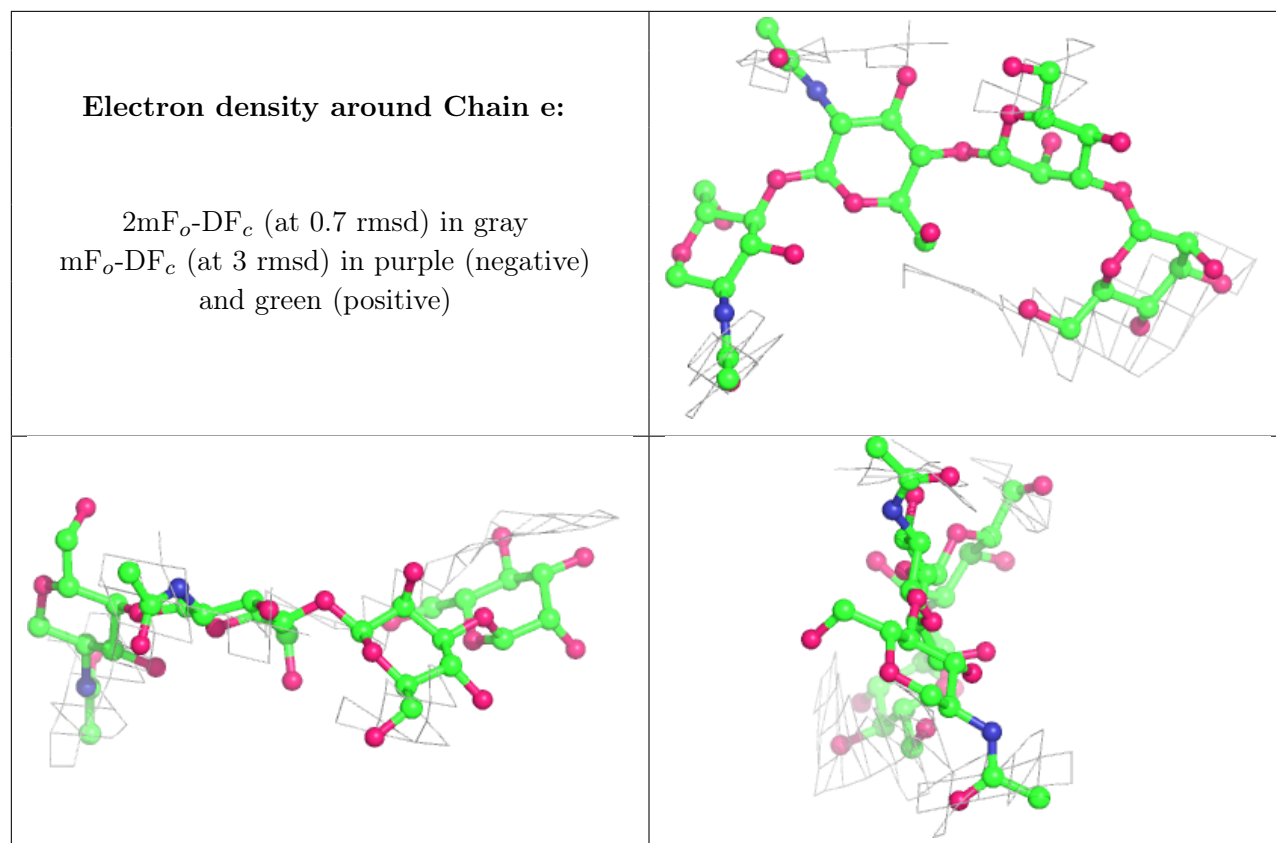

6.4 Ligands [i](#)

In the following table, the Atoms column lists the number of modelled atoms in the group and the number defined in the chemical component dictionary. The B-factors column lists the minimum, median, 95th percentile and maximum values of B factors of atoms in the group. The column labelled 'Q<0.9' lists the number of atoms with occupancy less than 0.9.

Mol	Type	Chain	Res	Atoms	RSCC	RSR	B-factors(\AA^2)	Q<0.9
10	NAG	S	2004	14/15	0.67	0.43	90,90,90,90	0
10	NAG	M	2003	14/15	0.68	0.40	90,90,90,90	0
10	NAG	A	2004	14/15	0.70	0.42	90,90,90,90	0
10	NAG	P	2001	14/15	0.73	0.43	90,90,90,90	0
10	NAG	C	2001	14/15	0.81	0.39	90,90,90,90	0
10	NAG	O	2004	14/15	0.87	0.24	90,90,90,90	0

6.5 Other polymers [i](#)

There are no such residues in this entry.