



wwPDB X-ray Structure Validation Summary Report ⓘ

Aug 6, 2020 – 09:18 PM BST

PDB ID : 6MFT
Title : Crystal structure of glycosylated 426c HIV-1 gp120 core G459C in complex with glVRC01 A60C heavy chain
Authors : Weidle, C.; Pancera, M.; Stamatatos, L.; Gray, M.
Deposited on : 2018-09-12
Resolution : 2.31 Å(reported)

This is a wwPDB X-ray Structure Validation Summary Report for a publicly released PDB entry.

We welcome your comments at validation@mail.wwpdb.org

A user guide is available at

<https://www.wwpdb.org/validation/2017/XrayValidationReportHelp>

with specific help available everywhere you see the ⓘ symbol.

The following versions of software and data (see [references ⓘ](#)) were used in the production of this report:

MolProbity : 4.02b-467
Mogul : 1.8.5 (274361), CSD as541be (2020)
Xtriage (Phenix) : 1.13
EDS : 2.13.1
buster-report : 1.1.7 (2018)
Percentile statistics : 20191225.v01 (using entries in the PDB archive December 25th 2019)
Refmac : 5.8.0158
CCP4 : 7.0.044 (Gargrove)
Ideal geometry (proteins) : Engh & Huber (2001)
Ideal geometry (DNA, RNA) : Parkinson et al. (1996)
Validation Pipeline (wwPDB-VP) : 2.13.1

1 Overall quality at a glance

The following experimental techniques were used to determine the structure:

X-RAY DIFFRACTION

The reported resolution of this entry is 2.31 Å.

Percentile scores (ranging between 0-100) for global validation metrics of the entry are shown in the following graphic. The table shows the number of entries on which the scores are based.

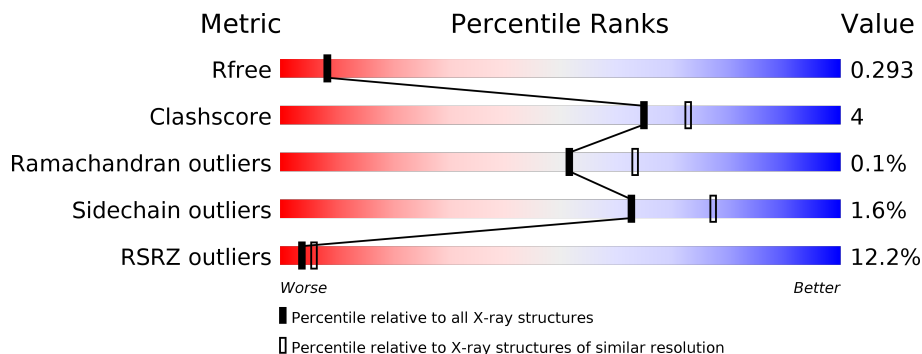



Metric	Whole archive (#Entries)	Similar resolution (#Entries, resolution range(Å))
R_{free}	130704	5974 (2.34-2.30)
Clashscore	141614	6604 (2.34-2.30)
Ramachandran outliers	138981	6523 (2.34-2.30)
Sidechain outliers	138945	6523 (2.34-2.30)
RSRZ outliers	127900	5855 (2.34-2.30)

The table below summarises the geometric issues observed across the polymeric chains and their fit to the electron density. The red, orange, yellow and green segments on the lower bar indicate the fraction of residues that contain outliers for ≥ 3 , 2, 1 and 0 types of geometric quality criteria respectively. A grey segment represents the fraction of residues that are not modelled. The numeric value for each fraction is indicated below the corresponding segment, with a dot representing fractions $\leq 5\%$. The upper red bar (where present) indicates the fraction of residues that have poor fit to the electron density. The numeric value is given above the bar.

Mol	Chain	Length	Quality of chain
1	A	233	
1	H	233	
2	B	210	
2	L	210	
3	C	347	
3	G	347	

Continued on next page...

Continued from previous page...

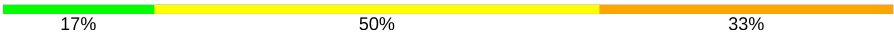
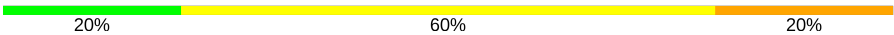
Mol	Chain	Length	Quality of chain
4	D	2	 50% 50%
4	E	2	 50% 50%
5	F	6	 17% 50% 33%
6	I	5	 20% 60% 20%

The following table lists non-polymeric compounds, carbohydrate monomers and non-standard residues in protein, DNA, RNA chains that are outliers for geometric or electron-density-fit criteria:

Mol	Type	Chain	Res	Chirality	Geometry	Clashes	Electron density
7	NAG	C	1609	-	-	-	X
7	NAG	G	508	-	-	-	X

2 Entry composition [i](#)

There are 11 unique types of molecules in this entry. The entry contains 23916 atoms, of which 11446 are hydrogens and 0 are deuteriums.

In the tables below, the ZeroOcc column contains the number of atoms modelled with zero occupancy, the AltConf column contains the number of residues with at least one atom in alternate conformation and the Trace column contains the number of residues modelled with at most 2 atoms.

- Molecule 1 is a protein called Heavy Chain glVRC01.

Mol	Chain	Residues	Atoms						ZeroOcc	AltConf	Trace
			Total	C	H	N	O	S			
1	H	216	Total	C	H	N	O	S	0	0	0
			3223	1034	1582	281	317	9			
1	A	215	Total	C	H	N	O	S	0	0	0
			3216	1032	1579	280	316	9			

- Molecule 2 is a protein called Light chain glVRC01.

Mol	Chain	Residues	Atoms						ZeroOcc	AltConf	Trace
			Total	C	H	N	O	S			
2	L	208	Total	C	H	N	O	S	0	0	0
			3158	1007	1554	269	324	4			
2	B	209	Total	C	H	N	O	S	0	0	0
			3177	1012	1564	270	327	4			

- Molecule 3 is a protein called Gp120.

Mol	Chain	Residues	Atoms						ZeroOcc	AltConf	Trace
			Total	C	H	N	O	S			
3	G	336	Total	C	H	N	O	S	0	1	0
			5199	1647	2572	454	502	24			
3	C	336	Total	C	H	N	O	S	0	0	0
			5192	1645	2568	454	502	23			

- Molecule 4 is an oligosaccharide called 2-acetamido-2-deoxy-beta-D-glucopyranose-(1-4)-2-acetamido-2-deoxy-beta-D-glucopyranose.



Mol	Chain	Residues	Atoms				ZeroOcc	AltConf	Trace
			Total	C	N	O			
4	D	2	Total	C	N	O	0	0	0
			28	16	2	10			

Continued on next page...

Continued from previous page...

Mol	Chain	Residues	Atoms				ZeroOcc	AltConf	Trace
			Total	C	N	O			
4	E	2	28	16	2	10	0	0	0

- Molecule 5 is an oligosaccharide called alpha-D-mannopyranose-(1-2)-alpha-D-mannopyranose-(1-3)-[alpha-D-mannopyranose-(1-6)]beta-D-mannopyranose-(1-4)-2-acetamido-2-deoxy-beta-D-glucopyranose-(1-4)-2-acetamido-2-deoxy-beta-D-glucopyranose.

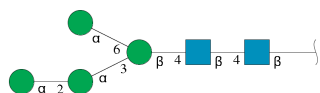

Mol	Chain	Residues	Atoms				ZeroOcc	AltConf	Trace
			Total	C	N	O			
5	F	6	72	40	2	30	0	0	0

- Molecule 6 is an oligosaccharide called alpha-D-mannopyranose-(1-3)-[alpha-D-mannopyranose-(1-6)]beta-D-mannopyranose-(1-4)-2-acetamido-2-deoxy-beta-D-glucopyranose-(1-4)-2-acetamido-2-deoxy-beta-D-glucopyranose.

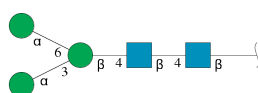

Mol	Chain	Residues	Atoms				ZeroOcc	AltConf	Trace
			Total	C	N	O			
6	I	5	61	34	2	25	0	0	0

- Molecule 7 is 2-acetamido-2-deoxy-beta-D-glucopyranose (three-letter code: NAG) (formula: C₈H₁₅NO₆) (labeled as "Ligand of Interest" by author).



Mol	Chain	Residues	Atoms				ZeroOcc	AltConf
			Total	C	N	O		
7	G	1	Total	C	N	O	0	0
			14	8	1	5		
7	G	1	Total	C	N	O	0	0
			14	8	1	5		
7	G	1	Total	C	N	O	0	0
			14	8	1	5		
7	G	1	Total	C	N	O	0	0
			14	8	1	5		
7	G	1	Total	C	N	O	0	0
			14	8	1	5		
7	G	1	Total	C	N	O	0	0
			14	8	1	5		
7	C	1	Total	C	N	O	0	0
			14	8	1	5		
7	C	1	Total	C	N	O	0	0
			14	8	1	5		
7	C	1	Total	C	N	O	0	0
			14	8	1	5		
7	C	1	Total	C	N	O	0	0
			14	8	1	5		

- Molecule 8 is DI(HYDROXYETHYL)ETHER (three-letter code: PEG) (formula: C₄H₁₀O₃).



Mol	Chain	Residues	Atoms				ZeroOcc	AltConf
			Total	C	H	O		
8	G	1	17	4	10	3	0	0

- Molecule 9 is CITRIC ACID (three-letter code: CIT) (formula: C₆H₈O₇).

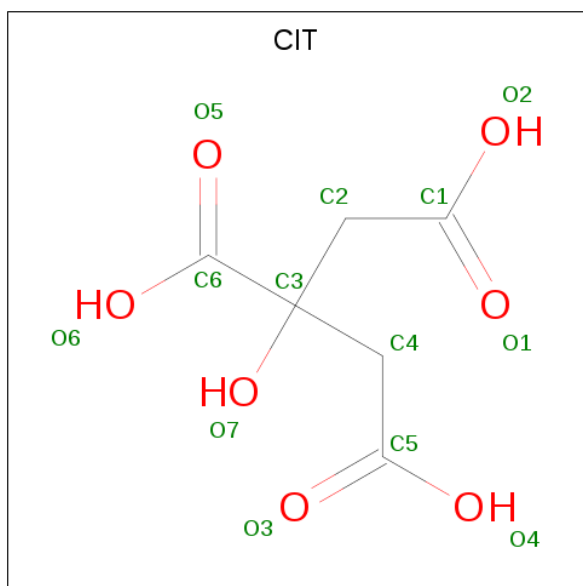

Mol	Chain	Residues	Atoms				ZeroOcc	AltConf
			Total	C	H	O		
9	C	1	18	6	5	7	0	0

- Molecule 10 is 1,2-ETHANEDIOL (three-letter code: EDO) (formula: C₂H₆O₂).

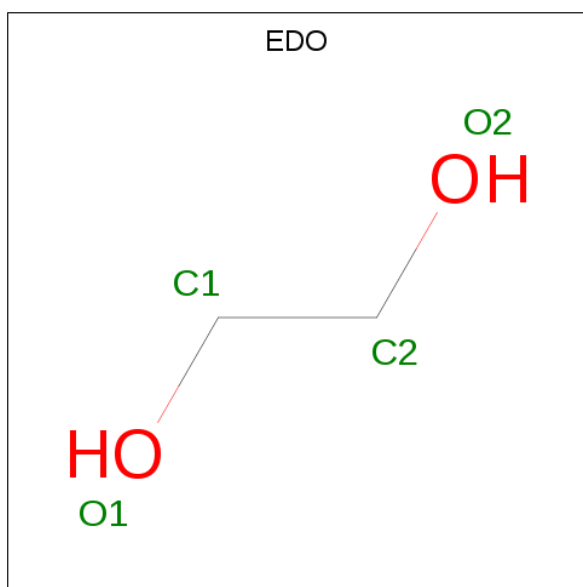

Mol	Chain	Residues	Atoms				ZeroOcc	AltConf
10	C	1	Total	C	H	O	0	0
			10	2	6	2		
10	C	1	Total	C	H	O	0	0
			10	2	6	2		

- Molecule 11 is water.

Mol	Chain	Residues	Atoms		ZeroOcc	AltConf
11	H	62	Total	O	0	0
			62	62		
11	L	44	Total	O	0	0
			44	44		
11	A	29	Total	O	0	0
			29	29		
11	B	23	Total	O	0	0
			23	23		
11	G	117	Total	O	0	0
			117	117		
11	C	50	Total	O	0	0
			50	50		

3 Residue-property plots [i](#)

These plots are drawn for all protein, RNA, DNA and oligosaccharide chains in the entry. The first graphic for a chain summarises the proportions of the various outlier classes displayed in the second graphic. The second graphic shows the sequence view annotated by issues in geometry and electron density. Residues are color-coded according to the number of geometric quality criteria for which they contain at least one outlier: green = 0, yellow = 1, orange = 2 and red = 3 or more. A red dot above a residue indicates a poor fit to the electron density ($RSRZ > 2$). Stretches of 2 or more consecutive residues without any outlier are shown as a green connector. Residues present in the sample, but not in the model, are shown in grey.

- Molecule 1: Heavy Chain glVRC01

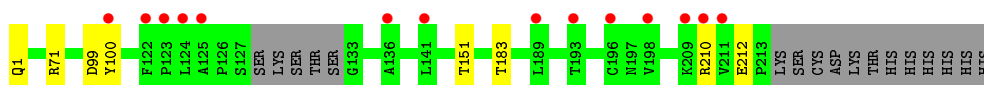
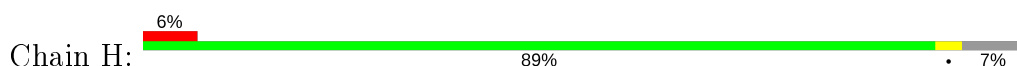

- Molecule 1: Heavy Chain glVRC01

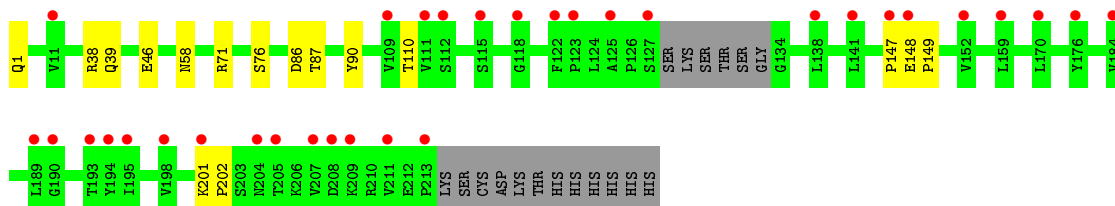
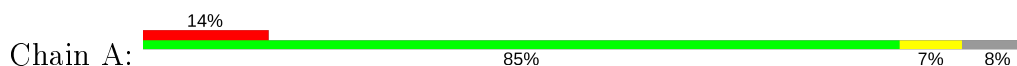

- Molecule 2: Light chain glVRC01

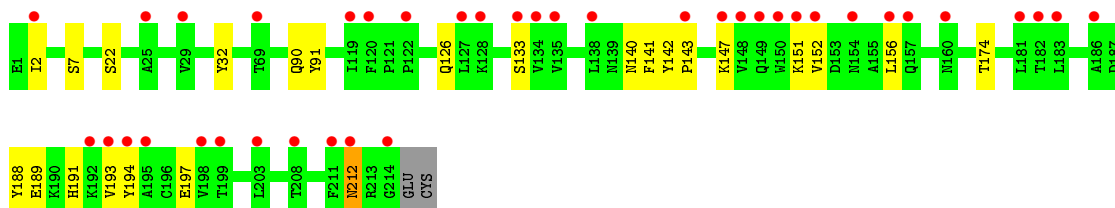
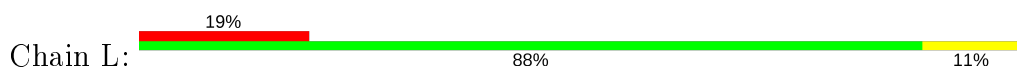

- Molecule 2: Light chain glVRC01

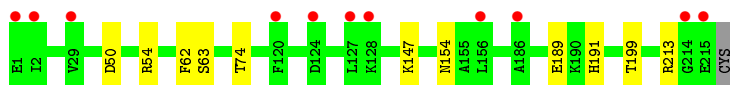

- Molecule 3: Gp120

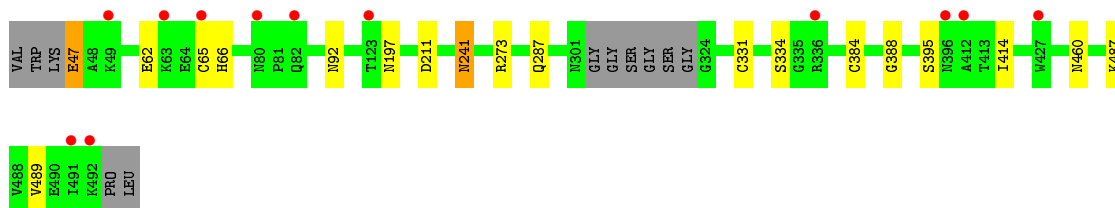
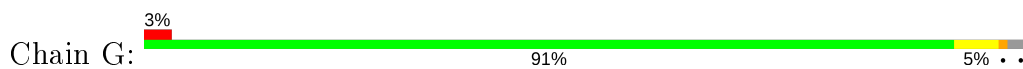

- Molecule 3: Gp120

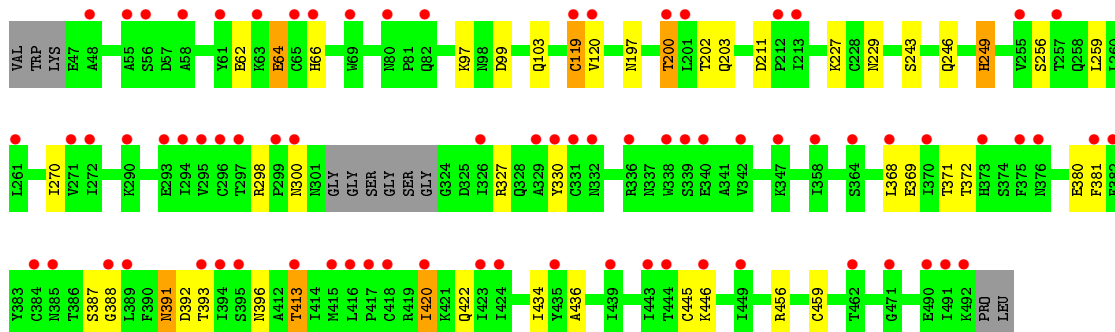
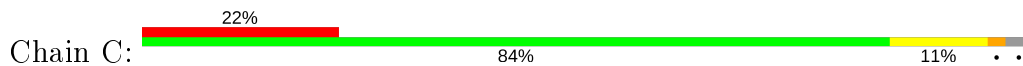

- Molecule 4: 2-acetamido-2-deoxy-beta-D-glucopyranose-(1-4)-2-acetamido-2-deoxy-beta-D-glucopyranose



- Molecule 4: 2-acetamido-2-deoxy-beta-D-glucopyranose-(1-4)-2-acetamido-2-deoxy-beta-D-glucopyranose



- Molecule 5: alpha-D-mannopyranose-(1-2)-alpha-D-mannopyranose-(1-3)-[alpha-D-mannopyranose-(1-6)]beta-D-mannopyranose-(1-4)-2-acetamido-2-deoxy-beta-D-glucopyranose-(1-4)-2-acetamido-2-deoxy-beta-D-glucopyranose

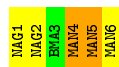
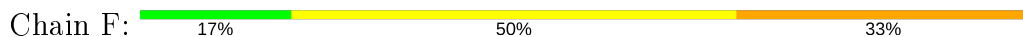

- Molecule 6: alpha-D-mannopyranose-(1-3)-[alpha-D-mannopyranose-(1-6)]beta-D-mannopyranose-(1-4)-2-acetamido-2-deoxy-beta-D-glucopyranose-(1-4)-2-acetamido-2-deoxy-beta-D-glucopyra

nose

Chain I:  20% 60% 20%

MAG1
MAG2
MAG3
MAIN4
MAIN5

4 Data and refinement statistics

Property	Value	Source
Space group	C 1 2 1	Depositor
Cell constants a, b, c, α , β , γ	197.08Å 109.00Å 103.22Å 90.00° 114.47° 90.00°	Depositor
Resolution (Å)	49.15 – 2.31 49.15 – 2.32	Depositor EDS
% Data completeness (in resolution range)	96.0 (49.15-2.31) 96.0 (49.15-2.32)	Depositor EDS
R_{merge}	(Not available)	Depositor
R_{sym}	(Not available)	Depositor
$\langle I/\sigma(I) \rangle$ ¹	2.35 (at 2.32Å)	Xtrriage
Refinement program	PHENIX (1.12_2829)	Depositor
R, R_{free}	0.244 , 0.295 0.241 , 0.293	Depositor DCC
R_{free} test set	4263 reflections (5.13%)	wwPDB-VP
Wilson B-factor (Å ²)	49.9	Xtrriage
Anisotropy	0.769	Xtrriage
Bulk solvent k_{sol} (e/Å ³), B_{sol} (Å ²)	0.35 , 49.6	EDS
L-test for twinning ²	$\langle L \rangle = 0.50$, $\langle L^2 \rangle = 0.33$	Xtrriage
Estimated twinning fraction	No twinning to report.	Xtrriage
F_o, F_c correlation	0.94	EDS
Total number of atoms	23916	wwPDB-VP
Average B, all atoms (Å ²)	81.0	wwPDB-VP

Xtrriage's analysis on translational NCS is as follows: *The largest off-origin peak in the Patterson function is 3.63% of the height of the origin peak. No significant pseudotranslation is detected.*

¹ Intensities estimated from amplitudes.

² Theoretical values of $\langle |L| \rangle$, $\langle L^2 \rangle$ for acentric reflections are 0.5, 0.333 respectively for untwinned datasets, and 0.375, 0.2 for perfectly twinned datasets.

5 Model quality [i](#)

5.1 Standard geometry [i](#)

Bond lengths and bond angles in the following residue types are not validated in this section: PCA, NAG, EDO, BMA, CIT, PEG, MAN

The Z score for a bond length (or angle) is the number of standard deviations the observed value is removed from the expected value. A bond length (or angle) with $|Z| > 5$ is considered an outlier worth inspection. RMSZ is the root-mean-square of all Z scores of the bond lengths (or angles).

Mol	Chain	Bond lengths		Bond angles	
		RMSZ	# Z >5	RMSZ	# Z >5
1	A	0.25	0/1673	0.47	0/2281
1	H	0.25	0/1677	0.46	0/2286
2	B	0.26	0/1648	0.46	0/2238
2	L	0.26	0/1639	0.48	0/2226
3	C	0.25	0/2676	0.45	0/3630
3	G	0.25	0/2682	0.45	0/3638
All	All	0.26	0/11995	0.46	0/16299

There are no bond length outliers.

There are no bond angle outliers.

There are no chirality outliers.

There are no planarity outliers.

5.2 Too-close contacts [i](#)

In the following table, the Non-H and H(model) columns list the number of non-hydrogen atoms and hydrogen atoms in the chain respectively. The H(added) column lists the number of hydrogen atoms added and optimized by MolProbity. The Clashes column lists the number of clashes within the asymmetric unit, whereas Symm-Clashes lists symmetry related clashes.

Mol	Chain	Non-H	H(model)	H(added)	Clashes	Symm-Clashes
1	A	1637	1579	1579	10	0
1	H	1641	1582	1582	3	0
2	B	1613	1564	1564	6	0
2	L	1604	1554	1558	15	0
3	C	2624	2568	2573	34	1
3	G	2627	2572	2574	19	0
4	D	28	0	25	1	0

Continued on next page...

Continued from previous page...

Mol	Chain	Non-H	H(model)	H(added)	Clashes	Symm-Clashes
4	E	28	0	25	3	0
5	F	72	0	61	6	0
6	I	61	0	52	5	0
7	C	84	0	78	14	0
7	G	98	0	91	8	0
8	G	7	10	10	0	0
9	C	13	5	5	1	0
10	C	8	12	12	0	0
11	A	29	0	0	1	0
11	B	23	0	0	0	0
11	C	50	0	0	5	0
11	G	117	0	0	1	0
11	H	62	0	0	1	0
11	L	44	0	0	2	0
All	All	12470	11446	11789	98	1

The all-atom clashscore is defined as the number of clashes found per 1000 atoms (including hydrogen atoms). The all-atom clashscore for this structure is 4.

The worst 5 of 98 close contacts within the same asymmetric unit are listed below, sorted by their clash magnitude.

Atom-1	Atom-2	Interatomic distance (Å)	Clash overlap (Å)
1:A:39:GLN:O	11:A:301:HOH:O	1.97	0.81
3:C:372:THR:OG1	11:C:1701:HOH:O	1.97	0.81
3:G:92:ASN:O	3:G:487:LYS:NZ	2.15	0.78
3:C:393:THR:CG2	7:C:1609:NAG:H4	2.15	0.76
3:G:197:ASN:OD1	7:G:511:NAG:H61	1.86	0.76

All (1) symmetry-related close contacts are listed below. The label for Atom-2 includes the symmetry operator and encoded unit-cell translations to be applied.

Atom-1	Atom-2	Interatomic distance (Å)	Clash overlap (Å)
3:C:200:THR:O	3:C:202:THR:H[2_557]	1.53	0.07

5.3 Torsion angles [i](#)

5.3.1 Protein backbone [i](#)

In the following table, the Percentiles column shows the percent Ramachandran outliers of the chain as a percentile score with respect to all X-ray entries followed by that with respect to entries of similar resolution.

The Analysed column shows the number of residues for which the backbone conformation was analysed, and the total number of residues.

Mol	Chain	Analysed	Favoured	Allowed	Outliers	Percentiles	
1	A	211/233 (91%)	201 (95%)	10 (5%)	0	100	100
1	H	212/233 (91%)	200 (94%)	12 (6%)	0	100	100
2	B	207/210 (99%)	193 (93%)	14 (7%)	0	100	100
2	L	206/210 (98%)	185 (90%)	20 (10%)	1 (0%)	29	35
3	C	332/347 (96%)	309 (93%)	22 (7%)	1 (0%)	41	50
3	G	333/347 (96%)	314 (94%)	19 (6%)	0	100	100
All	All	1501/1580 (95%)	1402 (93%)	97 (6%)	2 (0%)	51	63

All (2) Ramachandran outliers are listed below:

Mol	Chain	Res	Type
3	C	413	THR
2	L	140	ASN

5.3.2 Protein sidechains [i](#)

In the following table, the Percentiles column shows the percent sidechain outliers of the chain as a percentile score with respect to all X-ray entries followed by that with respect to entries of similar resolution.

The Analysed column shows the number of residues for which the sidechain conformation was analysed, and the total number of residues.

Mol	Chain	Analysed	Rotameric	Outliers	Percentiles	
1	A	181/198 (91%)	180 (99%)	1 (1%)	86	93
1	H	181/198 (91%)	179 (99%)	2 (1%)	73	85
2	B	181/182 (100%)	180 (99%)	1 (1%)	86	93
2	L	180/182 (99%)	178 (99%)	2 (1%)	73	85
3	C	300/307 (98%)	287 (96%)	13 (4%)	29	40

Continued on next page...

Continued from previous page...

Mol	Chain	Analysed	Rotameric	Outliers	Percentiles	
3	G	301/307 (98%)	299 (99%)	2 (1%)	84	92
All	All	1324/1374 (96%)	1303 (98%)	21 (2%)	62	77

5 of 21 residues with a non-rotameric sidechain are listed below:

Mol	Chain	Res	Type
3	C	119	CYS
3	C	249	HIS
3	C	413	THR
3	C	64	GLU
3	C	420	ILE

Some sidechains can be flipped to improve hydrogen bonding and reduce clashes. All (1) such sidechains are listed below:

Mol	Chain	Res	Type
2	L	90	GLN

5.3.3 RNA [i](#)

There are no RNA molecules in this entry.

5.4 Non-standard residues in protein, DNA, RNA chains [i](#)

2 non-standard protein/DNA/RNA residues are modelled in this entry.

In the following table, the Counts columns list the number of bonds (or angles) for which Mogul statistics could be retrieved, the number of bonds (or angles) that are observed in the model and the number of bonds (or angles) that are defined in the Chemical Component Dictionary. The Link column lists molecule types, if any, to which the group is linked. The Z score for a bond length (or angle) is the number of standard deviations the observed value is removed from the expected value. A bond length (or angle) with $|Z| > 2$ is considered an outlier worth inspection. RMSZ is the root-mean-square of all Z scores of the bond lengths (or angles).

Mol	Type	Chain	Res	Link	Bond lengths			Bond angles		
					Counts	RMSZ	$\# Z > 2$	Counts	RMSZ	$\# Z > 2$
1	PCA	H	1	1	7,8,9	2.21	2 (28%)	9,10,12	1.93	4 (44%)
1	PCA	A	1	1	7,8,9	2.20	2 (28%)	9,10,12	2.02	4 (44%)

In the following table, the Chirals column lists the number of chiral outliers, the number of chiral centers analysed, the number of these observed in the model and the number defined in the

Chemical Component Dictionary. Similar counts are reported in the Torsion and Rings columns. '-' means no outliers of that kind were identified.

Mol	Type	Chain	Res	Link	Chirals	Torsions	Rings
1	PCA	H	1	1	-	0/0/11/13	0/1/1/1
1	PCA	A	1	1	-	0/0/11/13	0/1/1/1

All (4) bond length outliers are listed below:

Mol	Chain	Res	Type	Atoms	Z	Observed(Å)	Ideal(Å)
1	A	1	PCA	CD-N	4.66	1.46	1.34
1	H	1	PCA	CD-N	4.64	1.46	1.34
1	H	1	PCA	CA-N	3.39	1.50	1.46
1	A	1	PCA	CA-N	3.32	1.50	1.46

The worst 5 of 8 bond angle outliers are listed below:

Mol	Chain	Res	Type	Atoms	Z	Observed(°)	Ideal(°)
1	A	1	PCA	CA-N-CD	-3.13	102.85	113.58
1	A	1	PCA	OE-CD-CG	-2.99	121.54	126.76
1	H	1	PCA	OE-CD-CG	-2.92	121.67	126.76
1	H	1	PCA	CA-N-CD	-2.88	103.71	113.58
1	A	1	PCA	CB-CA-N	2.44	110.29	103.30

There are no chirality outliers.

There are no torsion outliers.

There are no ring outliers.

No monomer is involved in short contacts.

5.5 Carbohydrates [i](#)

15 monosaccharides are modelled in this entry.

In the following table, the Counts columns list the number of bonds (or angles) for which Mogul statistics could be retrieved, the number of bonds (or angles) that are observed in the model and the number of bonds (or angles) that are defined in the Chemical Component Dictionary. The Link column lists molecule types, if any, to which the group is linked. The Z score for a bond length (or angle) is the number of standard deviations the observed value is removed from the expected value. A bond length (or angle) with $|Z| > 2$ is considered an outlier worth inspection. RMSZ is the root-mean-square of all Z scores of the bond lengths (or angles).

Mol	Type	Chain	Res	Link	Bond lengths			Bond angles		
					Counts	RMSZ	# Z > 2	Counts	RMSZ	# Z > 2
4	NAG	D	1	3,4	14,14,15	0.19	0	17,19,21	0.43	0
4	NAG	D	2	4	14,14,15	0.23	0	17,19,21	0.45	0
4	NAG	E	1	3,4	14,14,15	0.47	0	17,19,21	0.56	0
4	NAG	E	2	4	14,14,15	0.28	0	17,19,21	0.76	1 (5%)
5	NAG	F	1	3,5	14,14,15	0.37	0	17,19,21	0.59	0
5	NAG	F	2	5	14,14,15	0.22	0	17,19,21	0.41	0
5	BMA	F	3	5	11,11,12	0.63	0	15,15,17	0.81	0
5	MAN	F	4	5	11,11,12	0.75	0	15,15,17	1.02	1 (6%)
5	MAN	F	5	5	11,11,12	0.66	0	15,15,17	1.07	2 (13%)
5	MAN	F	6	5	11,11,12	0.64	0	15,15,17	1.26	3 (20%)
6	NAG	I	1	3,6	14,14,15	0.30	0	17,19,21	0.48	0
6	NAG	I	2	6	14,14,15	0.24	0	17,19,21	0.38	0
6	BMA	I	3	6	11,11,12	0.67	0	15,15,17	0.78	0
6	MAN	I	4	6	11,11,12	0.71	0	15,15,17	1.03	2 (13%)
6	MAN	I	5	6	11,11,12	1.05	1 (9%)	15,15,17	1.24	2 (13%)

In the following table, the Chirals column lists the number of chiral outliers, the number of chiral centers analysed, the number of these observed in the model and the number defined in the Chemical Component Dictionary. Similar counts are reported in the Torsion and Rings columns. '-' means no outliers of that kind were identified.

Mol	Type	Chain	Res	Link	Chirals	Torsions	Rings
4	NAG	D	1	3,4	-	2/6/23/26	0/1/1/1
4	NAG	D	2	4	-	0/6/23/26	0/1/1/1
4	NAG	E	1	3,4	-	2/6/23/26	0/1/1/1
4	NAG	E	2	4	-	2/6/23/26	0/1/1/1
5	NAG	F	1	3,5	-	2/6/23/26	0/1/1/1
5	NAG	F	2	5	-	2/6/23/26	0/1/1/1
5	BMA	F	3	5	-	0/2/19/22	0/1/1/1
5	MAN	F	4	5	-	2/2/19/22	0/1/1/1
5	MAN	F	5	5	-	0/2/19/22	0/1/1/1
5	MAN	F	6	5	-	1/2/19/22	0/1/1/1
6	NAG	I	1	3,6	-	0/6/23/26	0/1/1/1
6	NAG	I	2	6	-	0/6/23/26	0/1/1/1
6	BMA	I	3	6	-	2/2/19/22	0/1/1/1
6	MAN	I	4	6	-	1/2/19/22	0/1/1/1
6	MAN	I	5	6	-	2/2/19/22	0/1/1/1

All (1) bond length outliers are listed below:

Mol	Chain	Res	Type	Atoms	Z	Observed(Å)	Ideal(Å)
6	I	5	MAN	O5-C1	-2.01	1.40	1.43

The worst 5 of 11 bond angle outliers are listed below:

Mol	Chain	Res	Type	Atoms	Z	Observed(°)	Ideal(°)
4	E	2	NAG	C1-O5-C5	2.80	115.99	112.19
5	F	6	MAN	C1-O5-C5	2.69	115.83	112.19
5	F	4	MAN	O2-C2-C3	-2.45	105.23	110.14
6	I	4	MAN	C1-O5-C5	2.45	115.50	112.19
5	F	5	MAN	C1-O5-C5	2.37	115.40	112.19

There are no chirality outliers.

5 of 18 torsion outliers are listed below:

Mol	Chain	Res	Type	Atoms
5	F	4	MAN	O5-C5-C6-O6
6	I	3	BMA	O5-C5-C6-O6
4	E	1	NAG	C4-C5-C6-O6
4	E	1	NAG	O5-C5-C6-O6
4	D	1	NAG	O5-C5-C6-O6

There are no ring outliers.

10 monomers are involved in 15 short contacts:

Mol	Chain	Res	Type	Clashes	Symm-Clashes
6	I	4	MAN	1	0
5	F	5	MAN	1	0
6	I	1	NAG	3	0
4	E	2	NAG	3	0
6	I	2	NAG	3	0
5	F	1	NAG	2	0
4	E	1	NAG	3	0
4	D	1	NAG	1	0
5	F	2	NAG	3	0
5	F	4	MAN	3	0

The following is a two-dimensional graphical depiction of Mogul quality analysis of bond lengths, bond angles, torsion angles, and ring geometry for oligosaccharide.

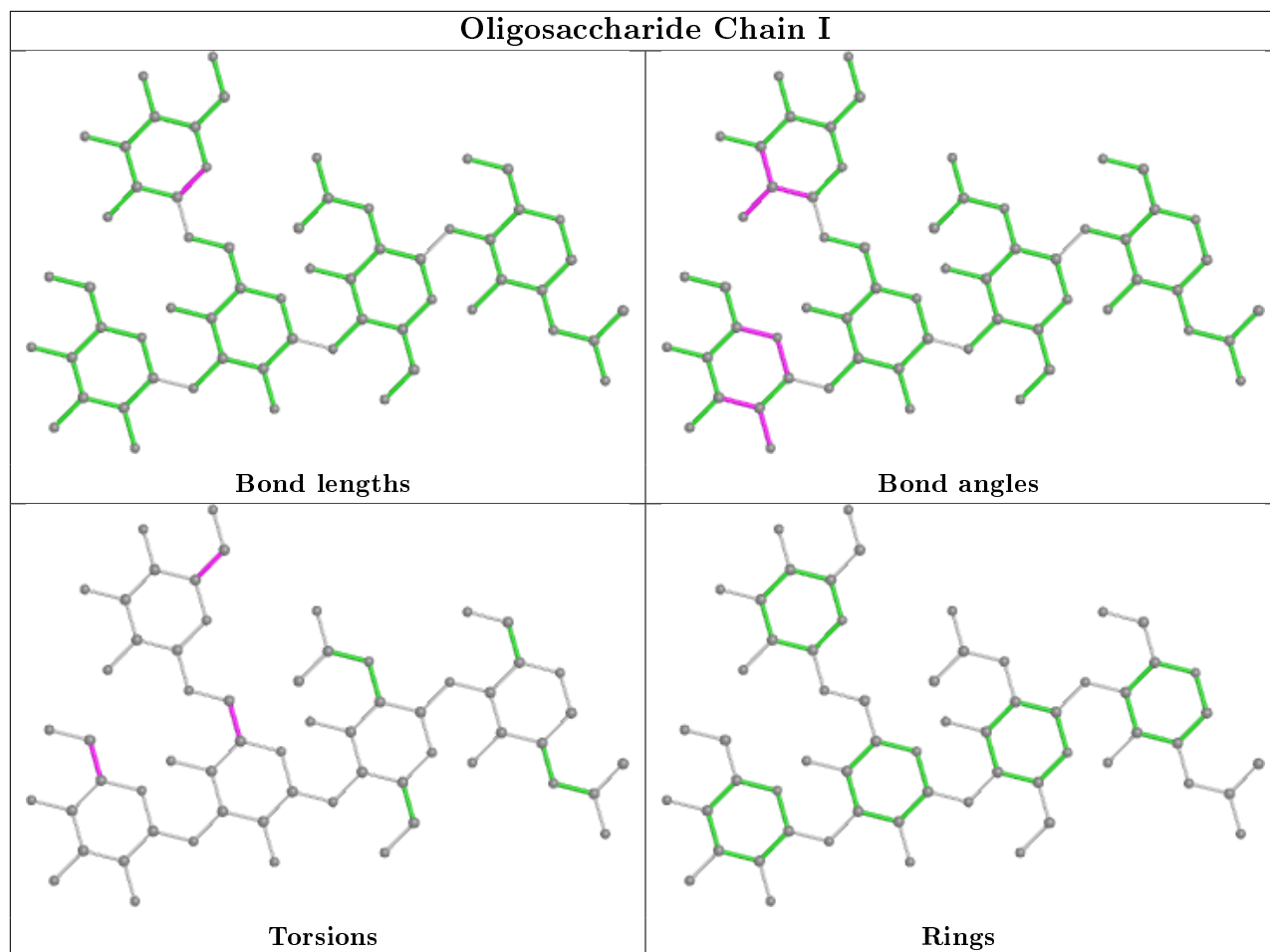

5.6 Ligand geometry [i](#)

17 ligands are modelled in this entry.

In the following table, the Counts columns list the number of bonds (or angles) for which Mogul statistics could be retrieved, the number of bonds (or angles) that are observed in the model and the number of bonds (or angles) that are defined in the Chemical Component Dictionary. The Link column lists molecule types, if any, to which the group is linked. The Z score for a bond length (or angle) is the number of standard deviations the observed value is removed from the expected value. A bond length (or angle) with $|Z| > 2$ is considered an outlier worth inspection. RMSZ is the root-mean-square of all Z scores of the bond lengths (or angles).

Mol	Type	Chain	Res	Link	Bond lengths			Bond angles		
					Counts	RMSZ	# $ Z > 2$	Counts	RMSZ	# $ Z > 2$
7	NAG	C	1609	3	14,14,15	0.22	0	17,19,21	0.37	0
7	NAG	C	1602	3	14,14,15	0.23	0	17,19,21	0.38	0
8	PEG	G	518	-	6,6,6	0.48	0	5,5,5	0.21	0
10	EDO	C	1613	-	3,3,3	0.44	0	2,2,2	0.32	0
7	NAG	C	1601	3	14,14,15	0.20	0	17,19,21	0.42	0
7	NAG	G	511	3	14,14,15	1.45	1 (7%)	17,19,21	1.65	1 (5%)

Mol	Type	Chain	Res	Link	Bond lengths			Bond angles		
					Counts	RMSZ	# Z > 2	Counts	RMSZ	# Z > 2
7	NAG	G	504	3	14,14,15	0.18	0	17,19,21	0.45	0
10	EDO	C	1614	-	3,3,3	0.45	0	2,2,2	0.30	0
7	NAG	G	501	3	14,14,15	0.27	0	17,19,21	0.44	0
7	NAG	C	1611	3	14,14,15	0.29	0	17,19,21	0.36	0
7	NAG	G	505	3	14,14,15	0.22	0	17,19,21	0.38	0
7	NAG	C	1603	3	14,14,15	0.52	0	17,19,21	0.77	1 (5%)
7	NAG	C	1610	3	14,14,15	0.26	0	17,19,21	0.50	0
7	NAG	G	506	3	14,14,15	0.23	0	17,19,21	0.43	0
9	CIT	C	1612	-	3,12,12	1.32	0	3,17,17	2.86	1 (33%)
7	NAG	G	508	3	14,14,15	0.25	0	17,19,21	0.44	0
7	NAG	G	507	3	14,14,15	0.22	0	17,19,21	0.40	0

In the following table, the Chirals column lists the number of chiral outliers, the number of chiral centers analysed, the number of these observed in the model and the number defined in the Chemical Component Dictionary. Similar counts are reported in the Torsion and Rings columns. '-' means no outliers of that kind were identified.

Mol	Type	Chain	Res	Link	Chirals	Torsions	Rings
7	NAG	C	1609	3	-	0/6/23/26	0/1/1/1
7	NAG	C	1602	3	-	2/6/23/26	0/1/1/1
8	PEG	G	518	-	-	0/4/4/4	-
10	EDO	C	1613	-	-	0/1/1/1	-
7	NAG	C	1601	3	-	2/6/23/26	0/1/1/1
7	NAG	G	511	3	-	3/6/23/26	0/1/1/1
7	NAG	G	504	3	-	2/6/23/26	0/1/1/1
10	EDO	C	1614	-	-	0/1/1/1	-
7	NAG	G	501	3	-	2/6/23/26	0/1/1/1
7	NAG	C	1611	3	-	2/6/23/26	0/1/1/1
7	NAG	G	505	3	-	2/6/23/26	0/1/1/1
7	NAG	C	1603	3	-	2/6/23/26	0/1/1/1
7	NAG	C	1610	3	-	2/6/23/26	0/1/1/1
7	NAG	G	506	3	-	4/6/23/26	0/1/1/1
9	CIT	C	1612	-	-	3/6/16/16	-
7	NAG	G	508	3	-	1/6/23/26	0/1/1/1
7	NAG	G	507	3	-	0/6/23/26	0/1/1/1

All (1) bond length outliers are listed below:

Mol	Chain	Res	Type	Atoms	Z	Observed(Å)	Ideal(Å)
7	G	511	NAG	O5-C1	5.27	1.52	1.43

All (3) bond angle outliers are listed below:

Mol	Chain	Res	Type	Atoms	Z	Observed(°)	Ideal(°)
7	G	511	NAG	C1-O5-C5	6.55	121.07	112.19
9	C	1612	CIT	C3-C4-C5	-4.40	107.95	114.98
7	C	1603	NAG	C1-O5-C5	2.89	116.11	112.19

There are no chirality outliers.

5 of 27 torsion outliers are listed below:

Mol	Chain	Res	Type	Atoms
7	C	1611	NAG	C1-C2-N2-C7
9	C	1612	CIT	O7-C3-C4-C5
9	C	1612	CIT	C6-C3-C4-C5
7	G	506	NAG	C4-C5-C6-O6
7	G	505	NAG	O5-C5-C6-O6

There are no ring outliers.

10 monomers are involved in 23 short contacts:

Mol	Chain	Res	Type	Clashes	Symm-Clashes
7	C	1609	NAG	5	0
7	C	1602	NAG	2	0
7	G	511	NAG	2	0
7	G	501	NAG	2	0
7	C	1611	NAG	3	0
7	G	505	NAG	3	0
7	C	1603	NAG	3	0
7	C	1610	NAG	1	0
9	C	1612	CIT	1	0
7	G	508	NAG	1	0

The following is a two-dimensional graphical depiction of Mogul quality analysis of bond lengths, bond angles, torsion angles, and ring geometry for all instances of the Ligand of Interest. In addition, ligands with molecular weight > 250 and outliers as shown on the validation Tables will also be included. For torsion angles, if less than 5% of the Mogul distribution of torsion angles is within 10 degrees of the torsion angle in question, then that torsion angle is considered an outlier. Any bond that is central to one or more torsion angles identified as an outlier by Mogul will be highlighted in the graph. For rings, the root-mean-square deviation (RMSD) between the ring in question and similar rings identified by Mogul is calculated over all ring torsion angles. If the

average RMSD is greater than 60 degrees and the minimal RMSD between the ring in question and any Mogul-identified rings is also greater than 60 degrees, then that ring is considered an outlier. The outliers are highlighted in purple. The color gray indicates Mogul did not find sufficient equivalents in the CSD to analyse the geometry.

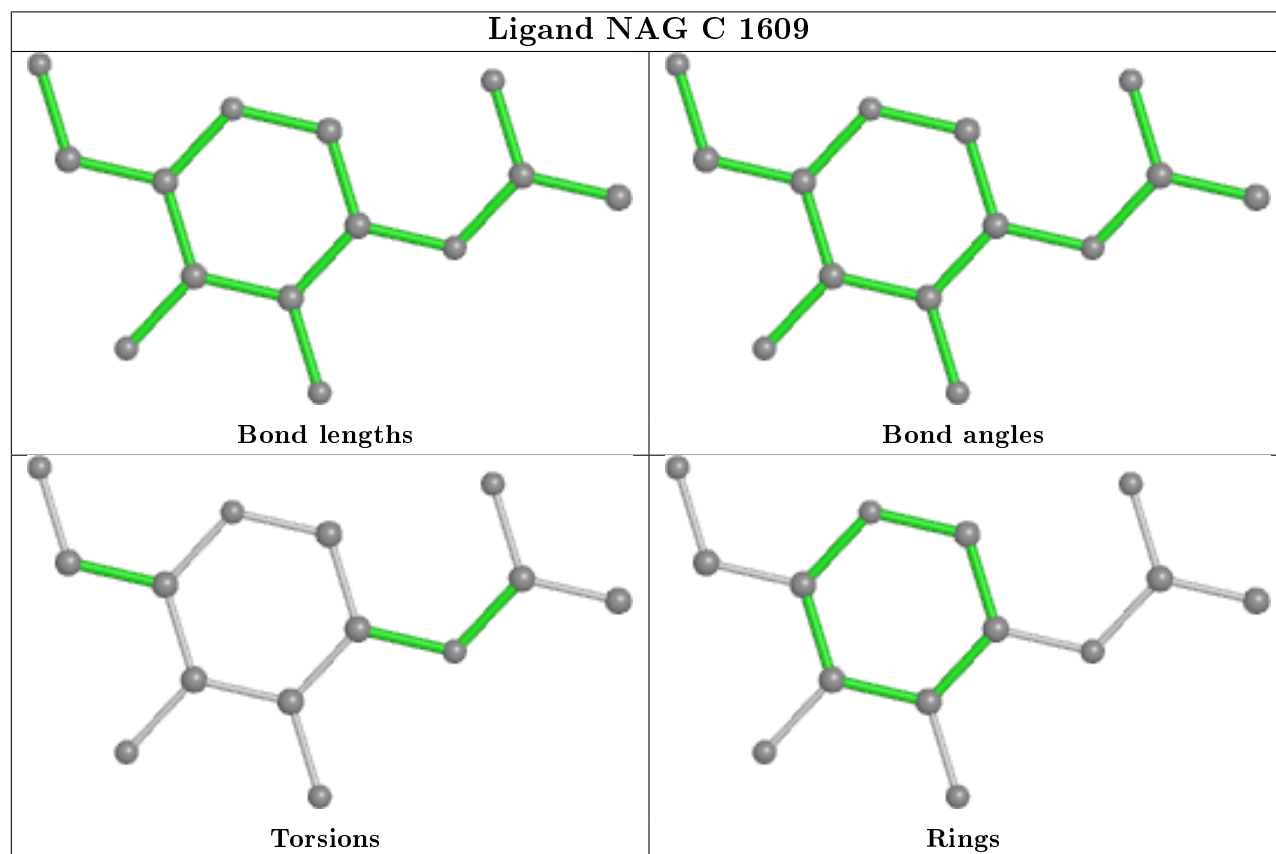

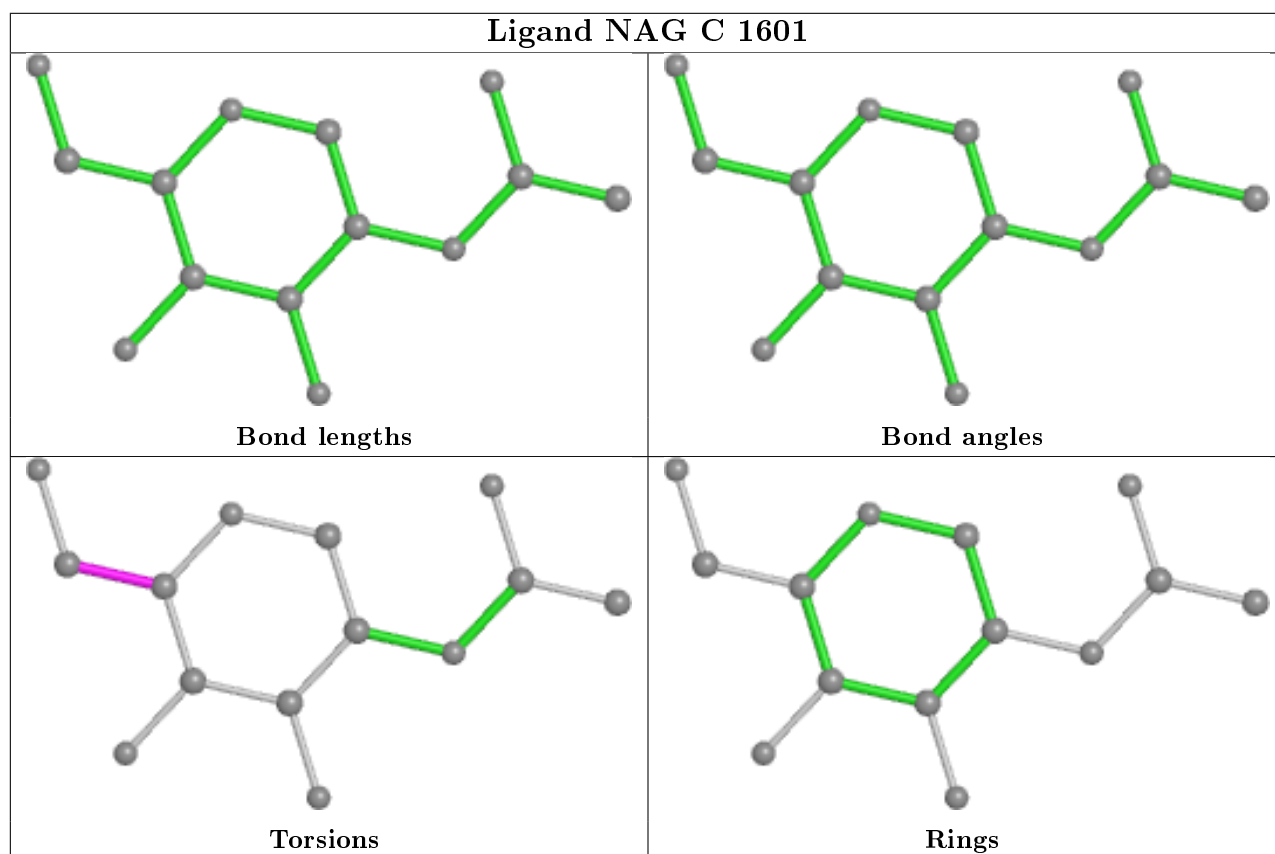
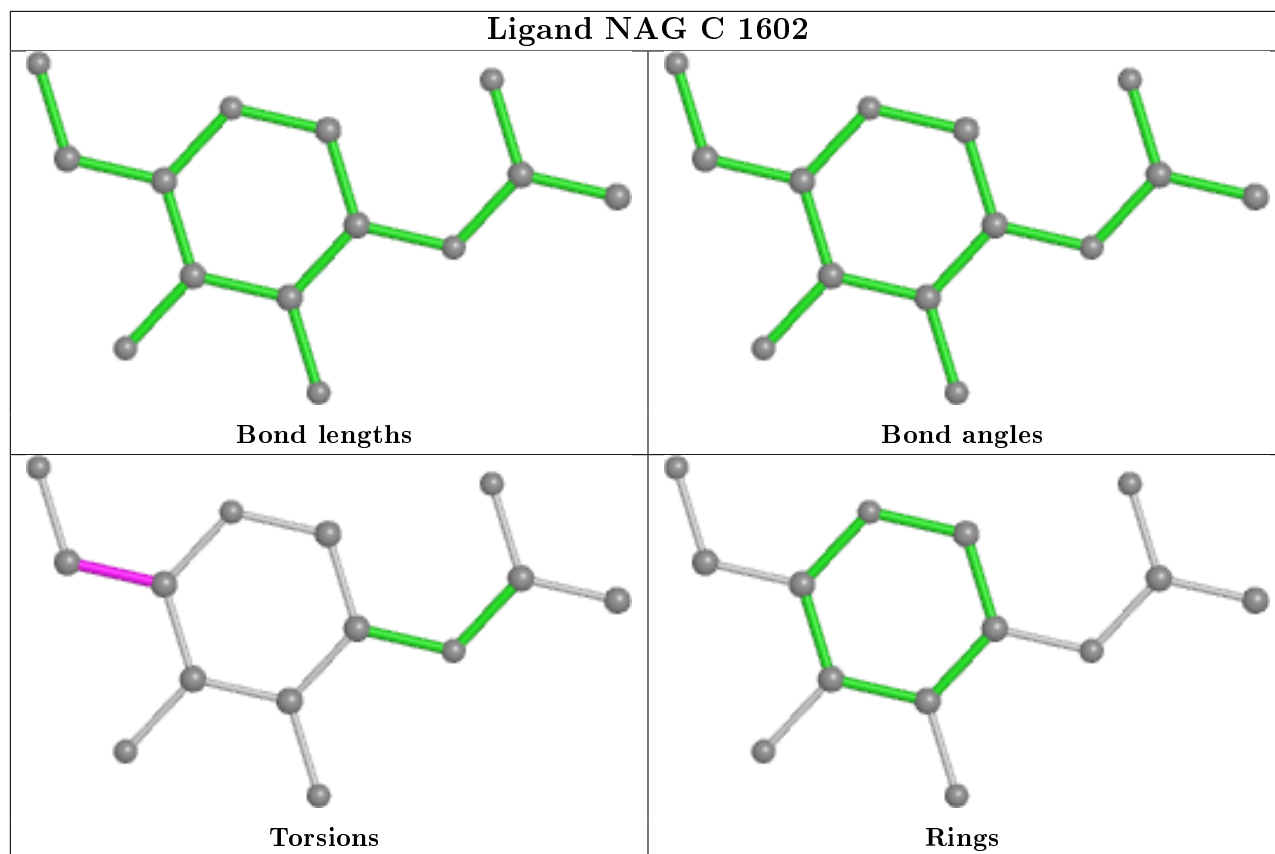

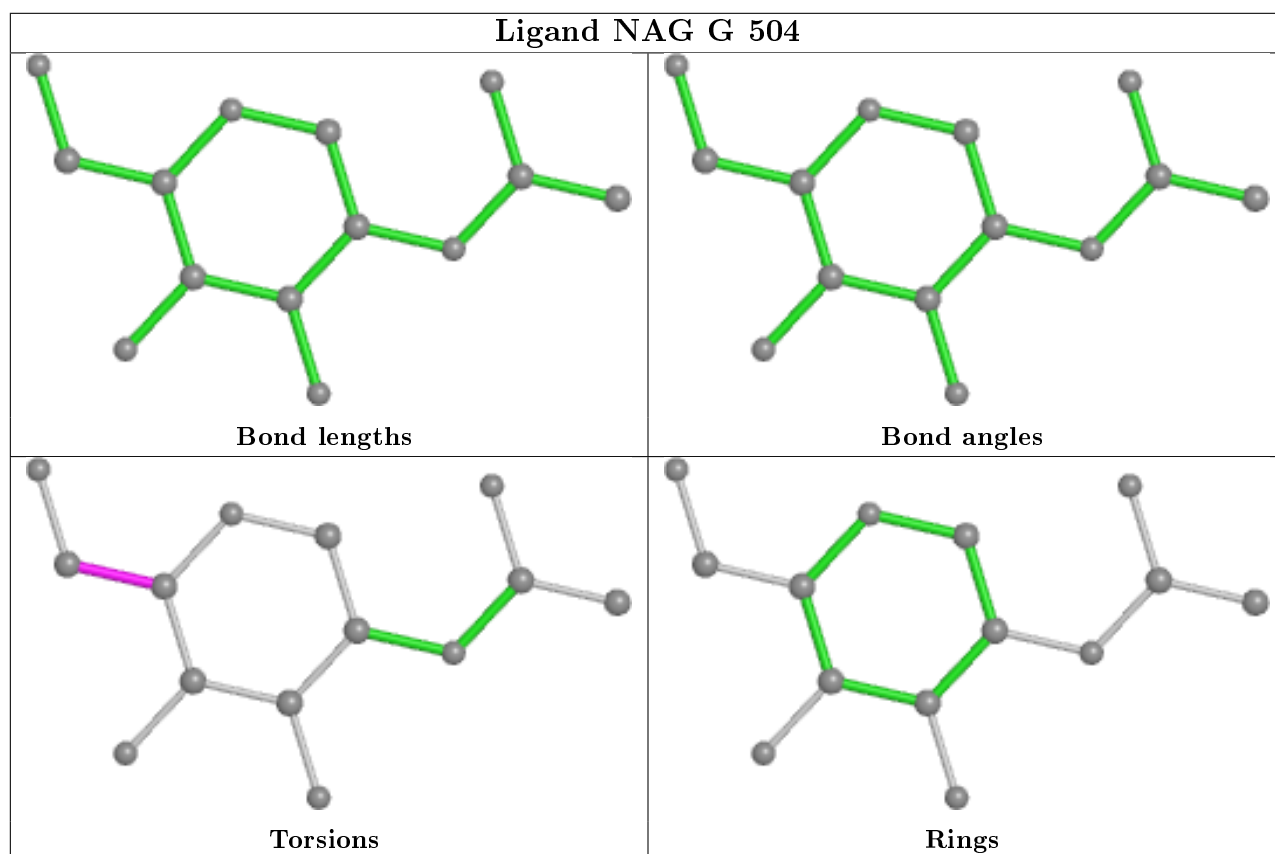
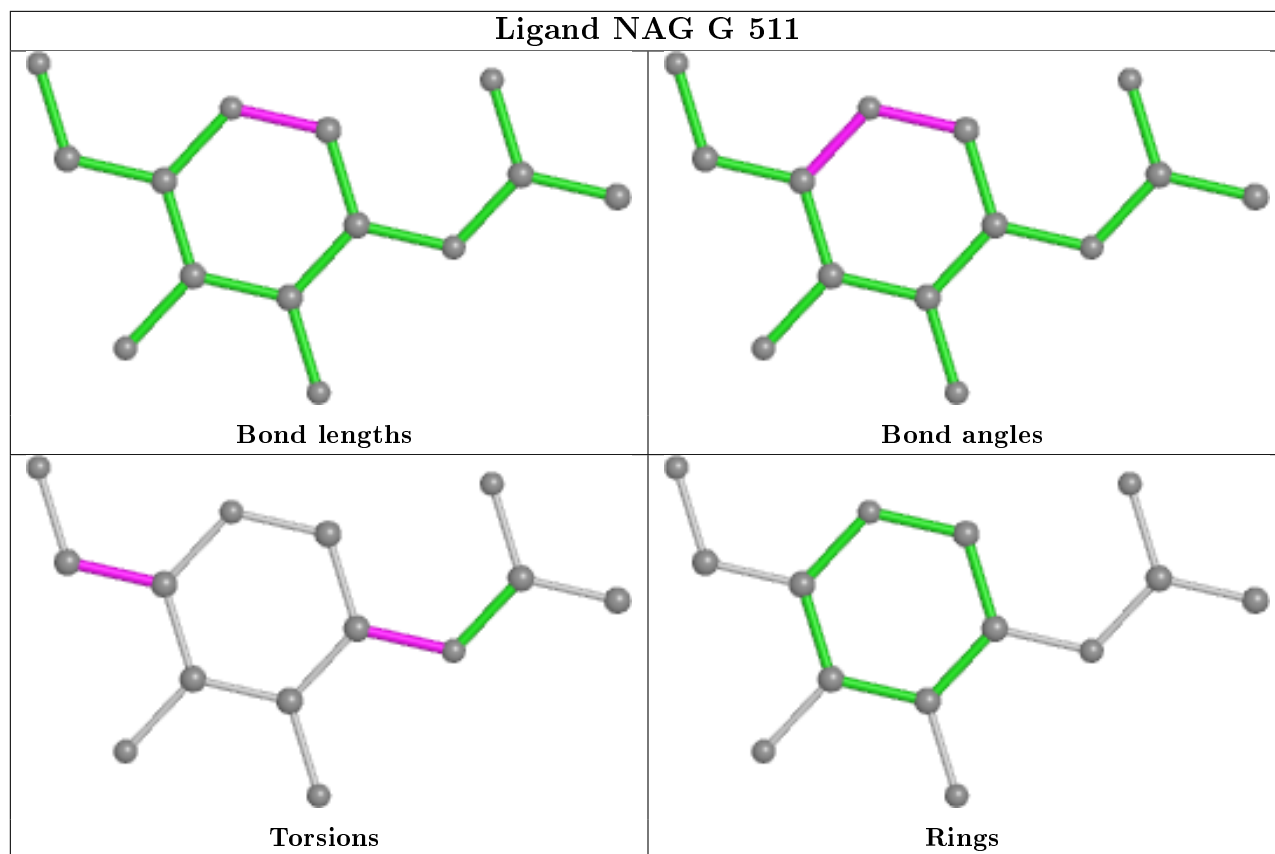

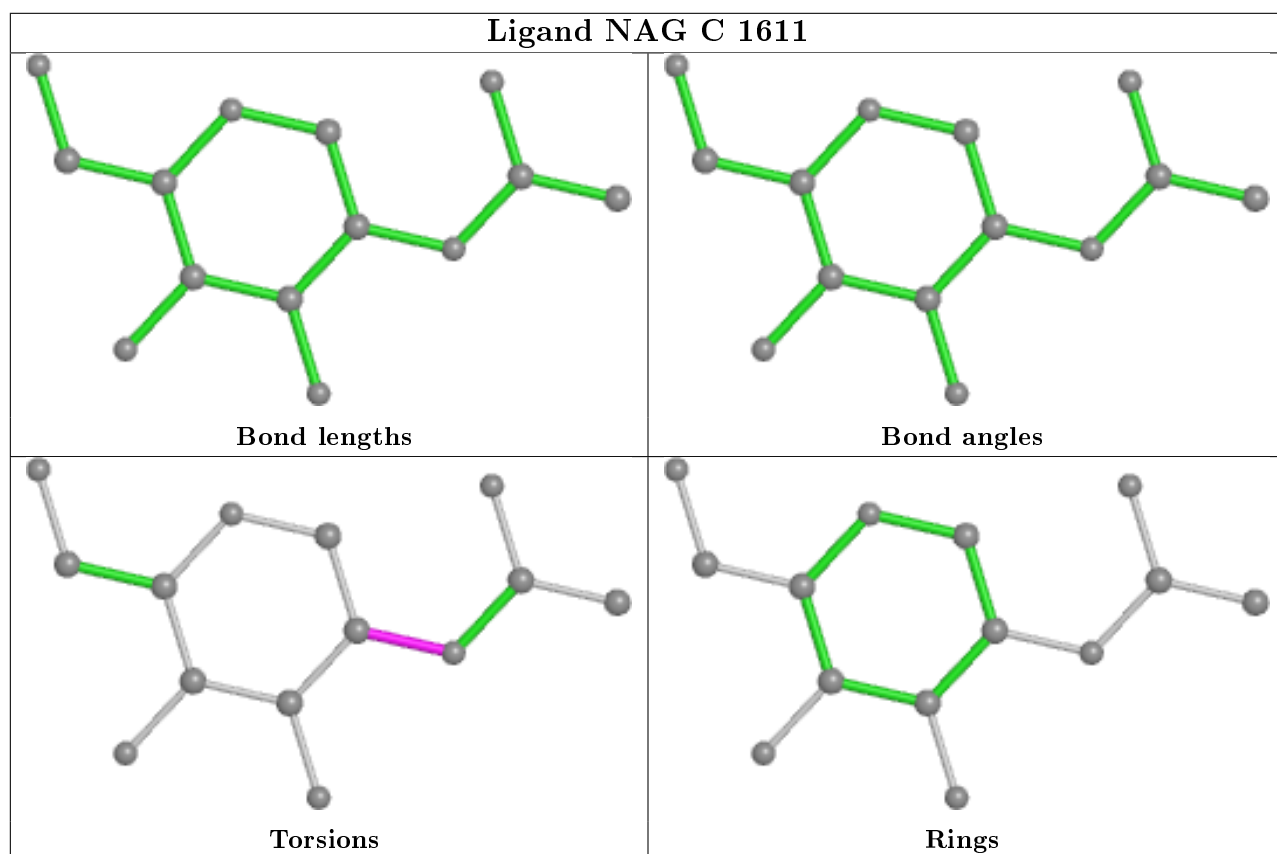
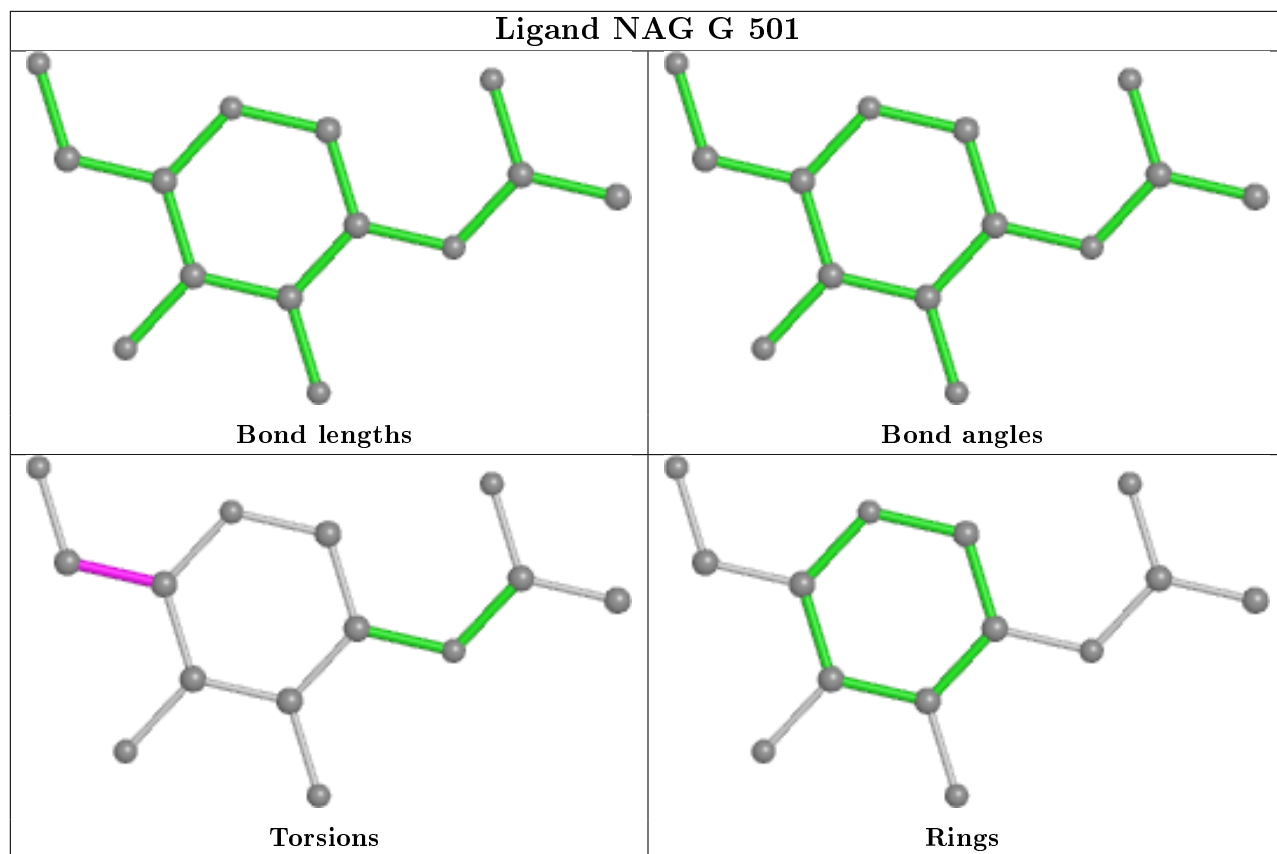

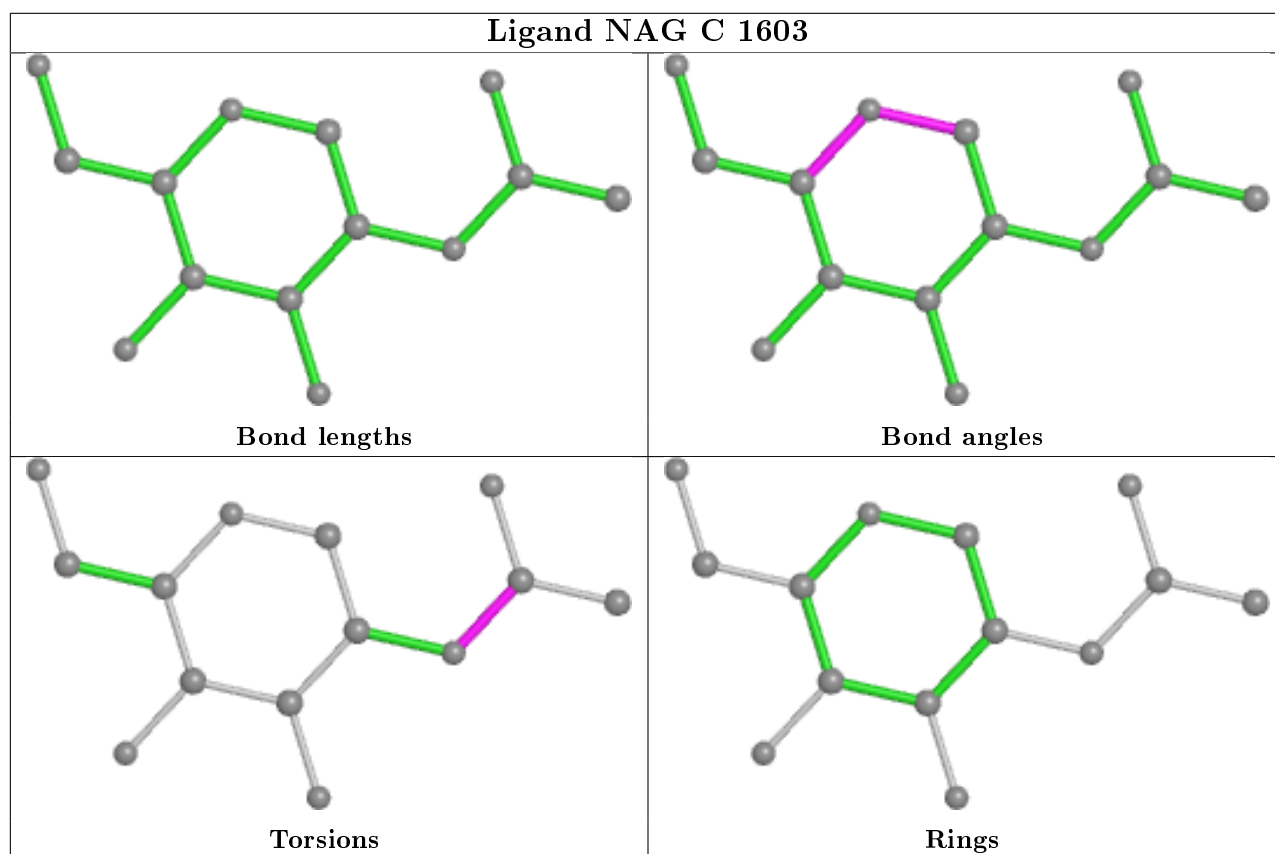
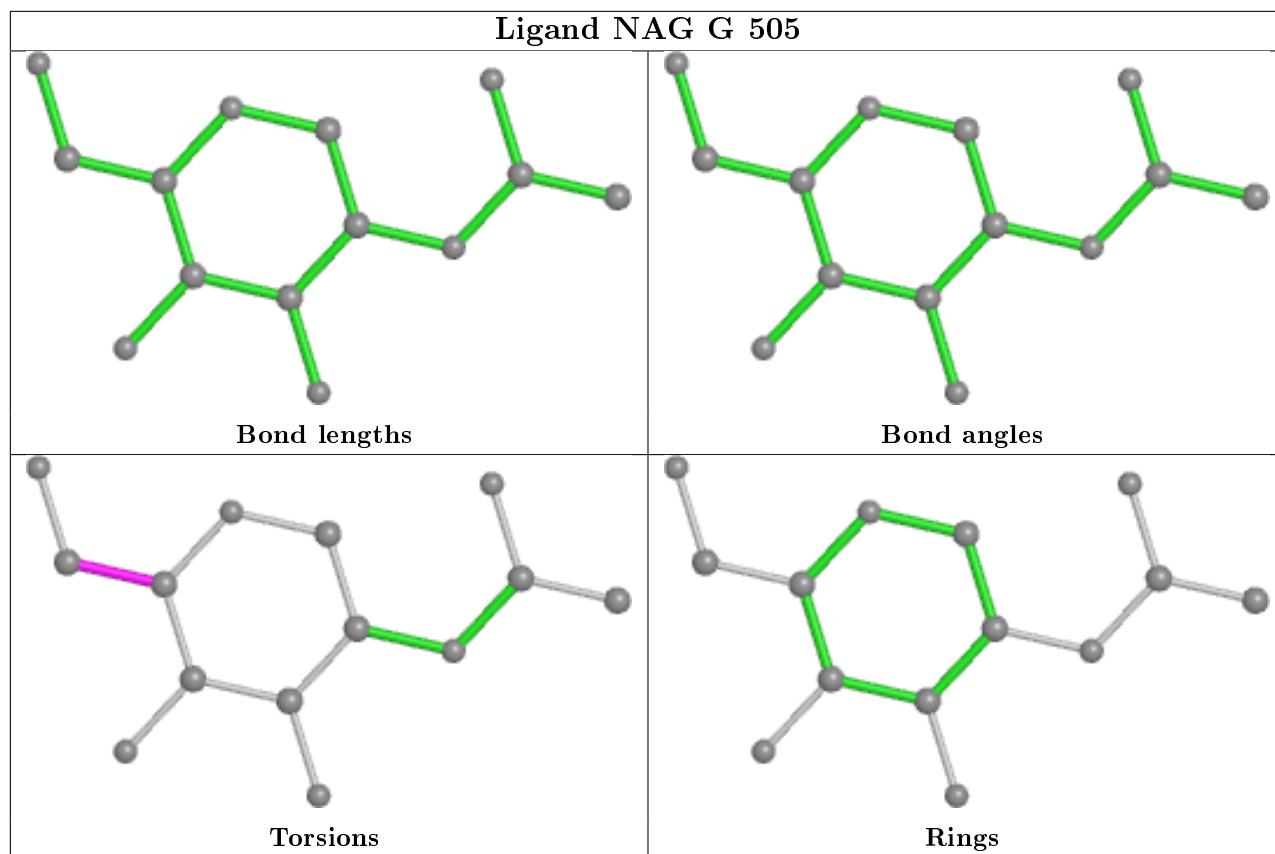

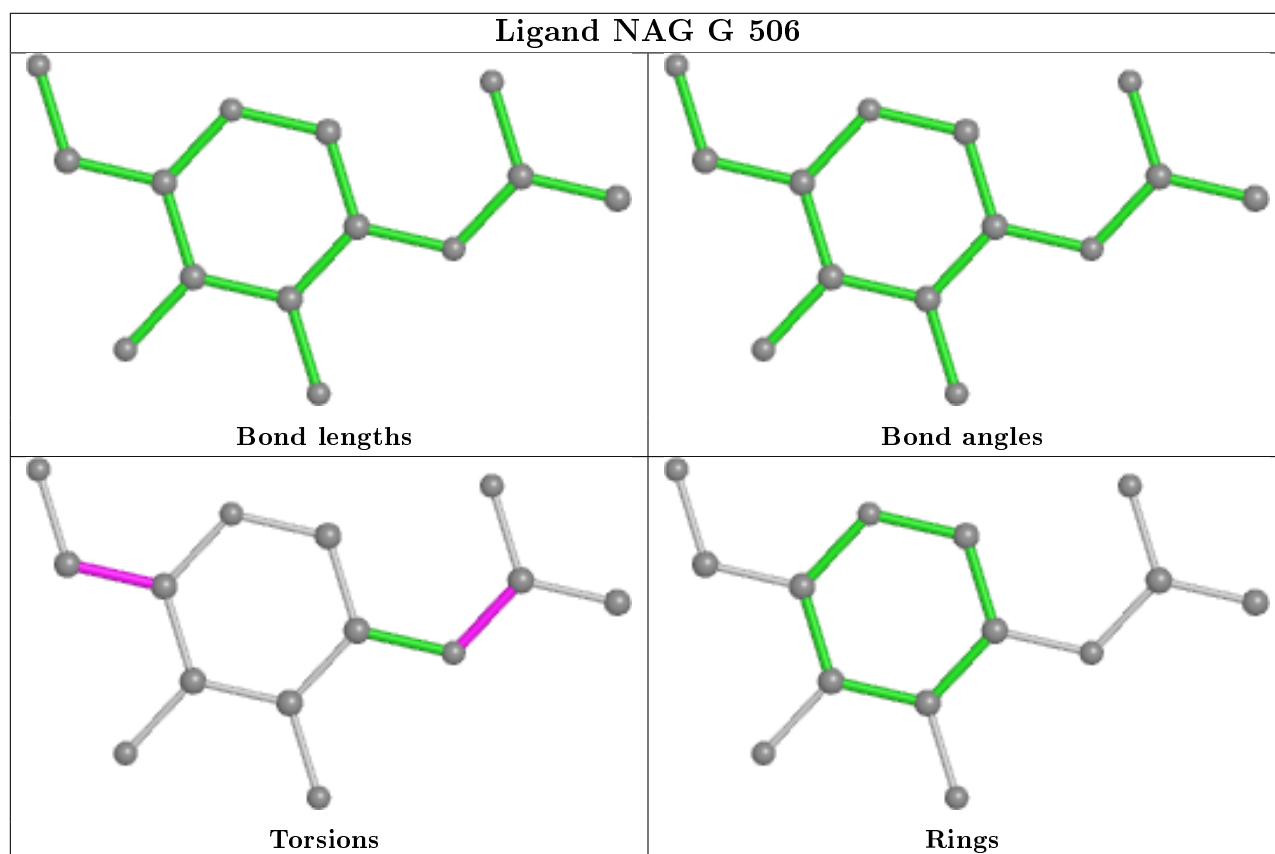
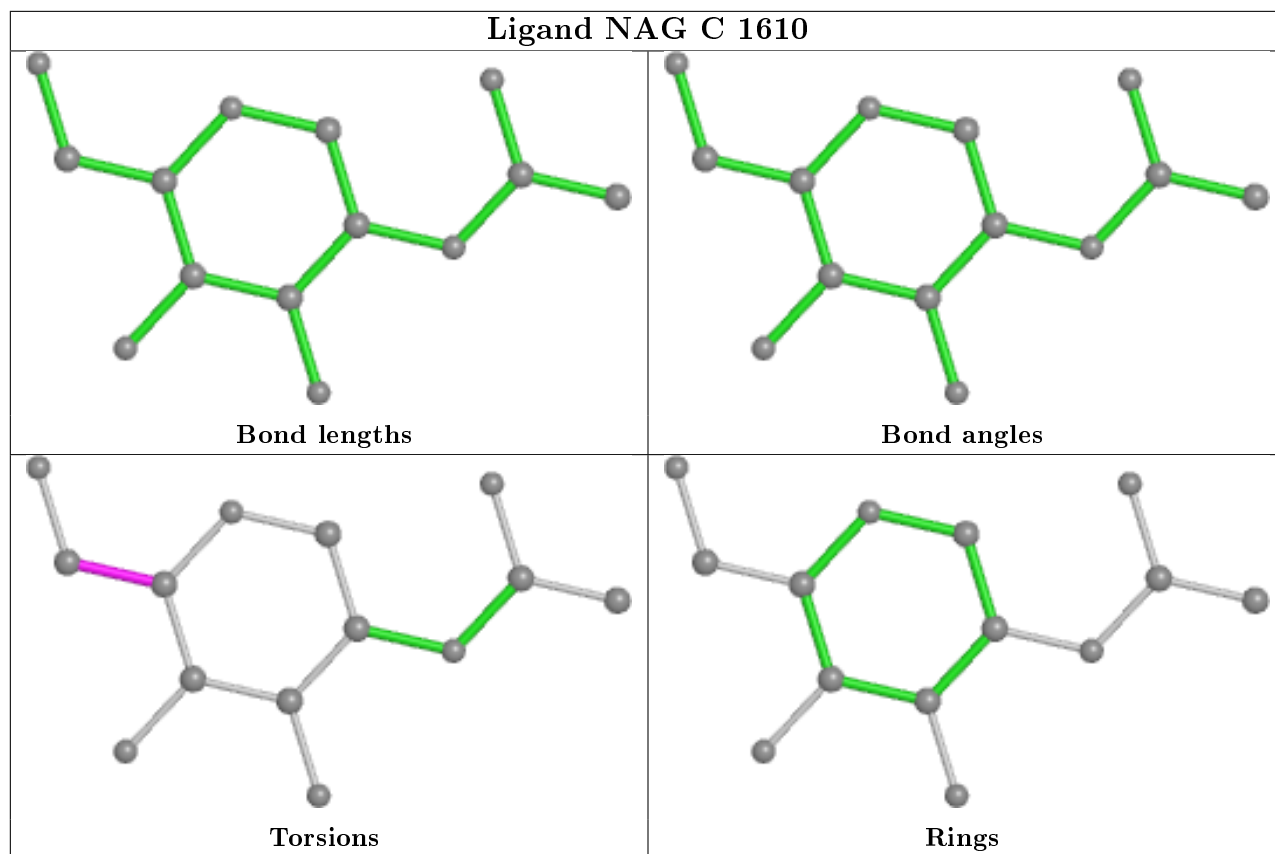

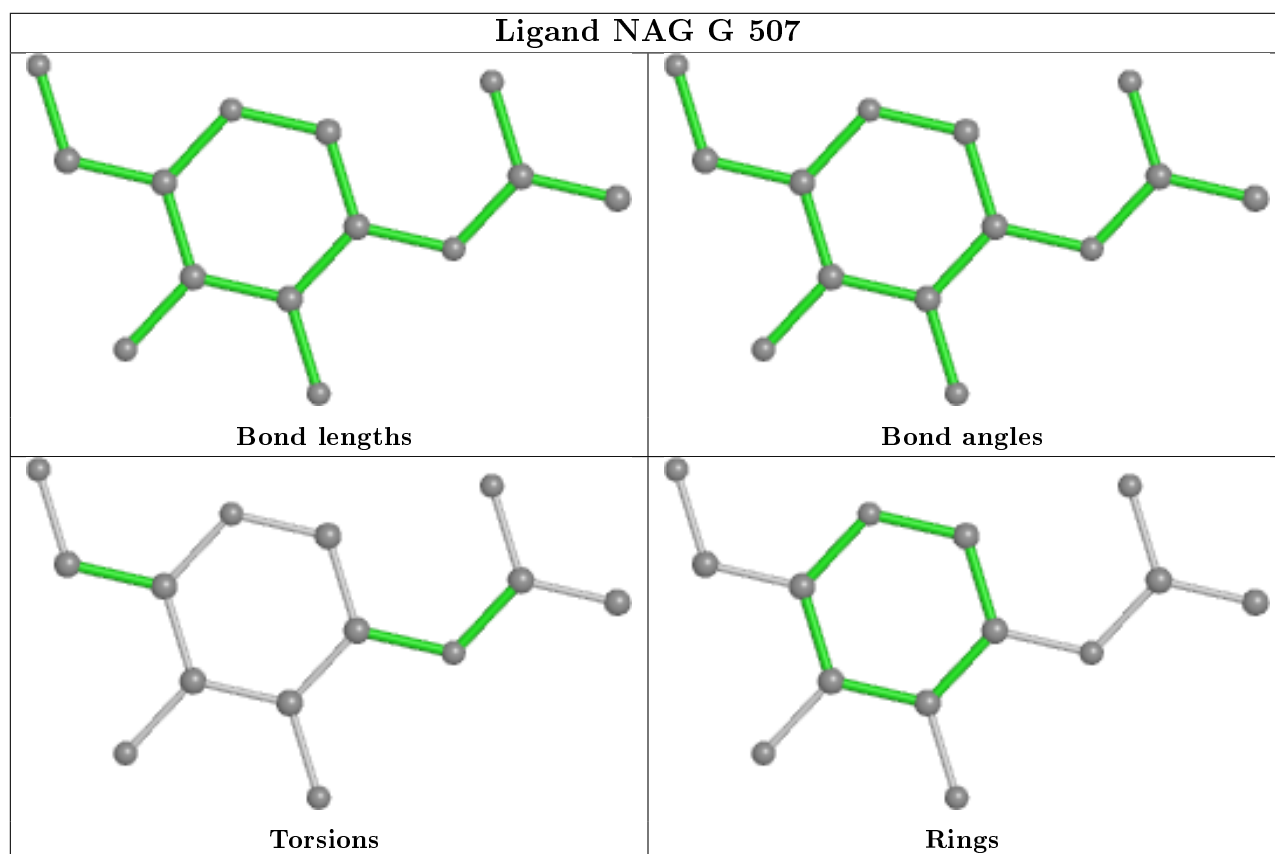
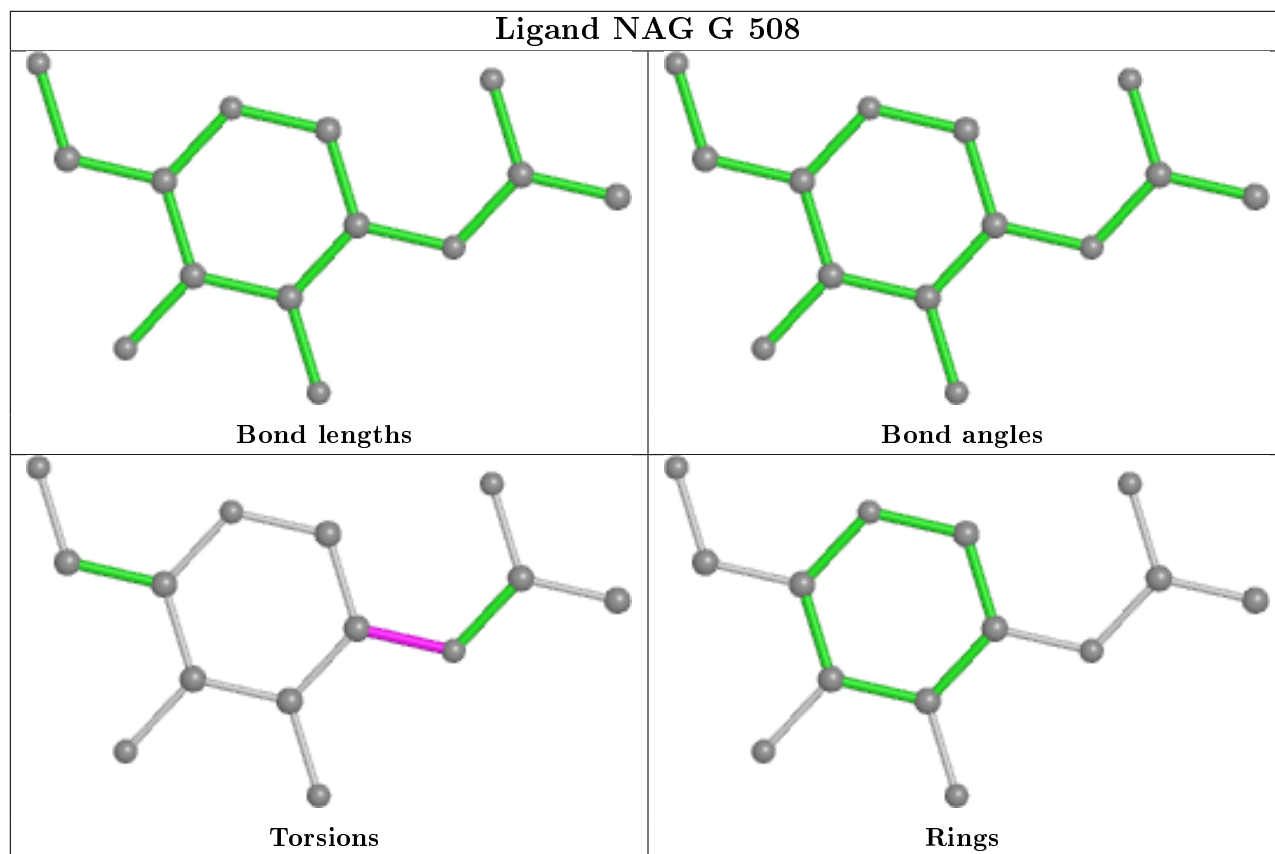

5.7 Other polymers [i](#)

There are no such residues in this entry.

5.8 Polymer linkage issues [i](#)

There are no chain breaks in this entry.

6 Fit of model and data [i](#)

6.1 Protein, DNA and RNA chains [i](#)

In the following table, the column labelled ‘#RSRZ> 2’ contains the number (and percentage) of RSRZ outliers, followed by percent RSRZ outliers for the chain as percentile scores relative to all X-ray entries and entries of similar resolution. The OWAB column contains the minimum, median, 95th percentile and maximum values of the occupancy-weighted average B-factor per residue. The column labelled ‘Q< 0.9’ lists the number of (and percentage) of residues with an average occupancy less than 0.9.

Mol	Chain	Analysed	<RSRZ>	#RSRZ>2	OWAB(Å ²)	Q<0.9
1	A	214/233 (91%)	0.95	33 (15%) 2 3	47, 81, 114, 126	0
1	H	215/233 (92%)	0.51	14 (6%) 18 24	41, 67, 103, 125	0
2	B	209/210 (99%)	0.54	11 (5%) 26 33	46, 72, 106, 131	0
2	L	208/210 (99%)	1.16	39 (18%) 1 1	43, 77, 120, 133	0
3	C	336/347 (96%)	1.32	76 (22%) 0 1	51, 78, 106, 125	0
3	G	336/347 (96%)	0.59	12 (3%) 42 49	38, 59, 89, 118	0
All	All	1518/1580 (96%)	0.86	185 (12%) 4 6	38, 71, 109, 133	0

The worst 5 of 185 RSRZ outliers are listed below:

Mol	Chain	Res	Type	RSRZ
3	C	295	VAL	7.3
3	C	65	CYS	5.9
1	A	190	GLY	5.8
1	A	213	PRO	5.7
2	L	211	PHE	5.6

6.2 Non-standard residues in protein, DNA, RNA chains [i](#)

In the following table, the Atoms column lists the number of modelled atoms in the group and the number defined in the chemical component dictionary. The B-factors column lists the minimum, median, 95th percentile and maximum values of B factors of atoms in the group. The column labelled ‘Q< 0.9’ lists the number of atoms with occupancy less than 0.9.

Mol	Type	Chain	Res	Atoms	RSCC	RSR	B-factors(Å ²)	Q<0.9
1	PCA	H	1	8/9	0.78	0.18	72,94,107,107	0
1	PCA	A	1	8/9	0.90	0.19	75,109,121,130	0

6.3 Carbohydrates

In the following table, the Atoms column lists the number of modelled atoms in the group and the number defined in the chemical component dictionary. The B-factors column lists the minimum, median, 95th percentile and maximum values of B factors of atoms in the group. The column labelled 'Q<0.9' lists the number of atoms with occupancy less than 0.9.

Mol	Type	Chain	Res	Atoms	RSCC	RSR	B-factors(Å ²)	Q<0.9
6	MAN	I	5	11/12	0.41	0.32	110,120,131,132	0
6	BMA	I	3	11/12	0.57	0.16	105,119,122,126	0
6	NAG	I	1	14/15	0.67	0.24	71,91,104,107	0
6	MAN	I	4	11/12	0.68	0.26	99,113,120,121	0
6	NAG	I	2	14/15	0.70	0.22	78,100,111,112	0
4	NAG	D	1	14/15	0.75	0.28	74,89,101,102	0
4	NAG	D	2	14/15	0.77	0.26	91,102,110,110	0
4	NAG	E	2	14/15	0.78	0.38	81,101,113,117	0
5	MAN	F	6	11/12	0.78	0.18	81,105,111,119	0
5	MAN	F	4	11/12	0.81	0.27	94,98,103,106	0
5	BMA	F	3	11/12	0.86	0.19	91,99,108,109	0
4	NAG	E	1	14/15	0.87	0.18	61,69,82,99	0
5	NAG	F	2	14/15	0.89	0.13	60,72,83,86	0
5	MAN	F	5	11/12	0.90	0.40	96,102,114,117	0
5	NAG	F	1	14/15	0.94	0.11	45,55,63,69	0

The following is a graphical depiction of the model fit to experimental electron density for oligosaccharide. Each fit is shown from different orientation to approximate a three-dimensional view.

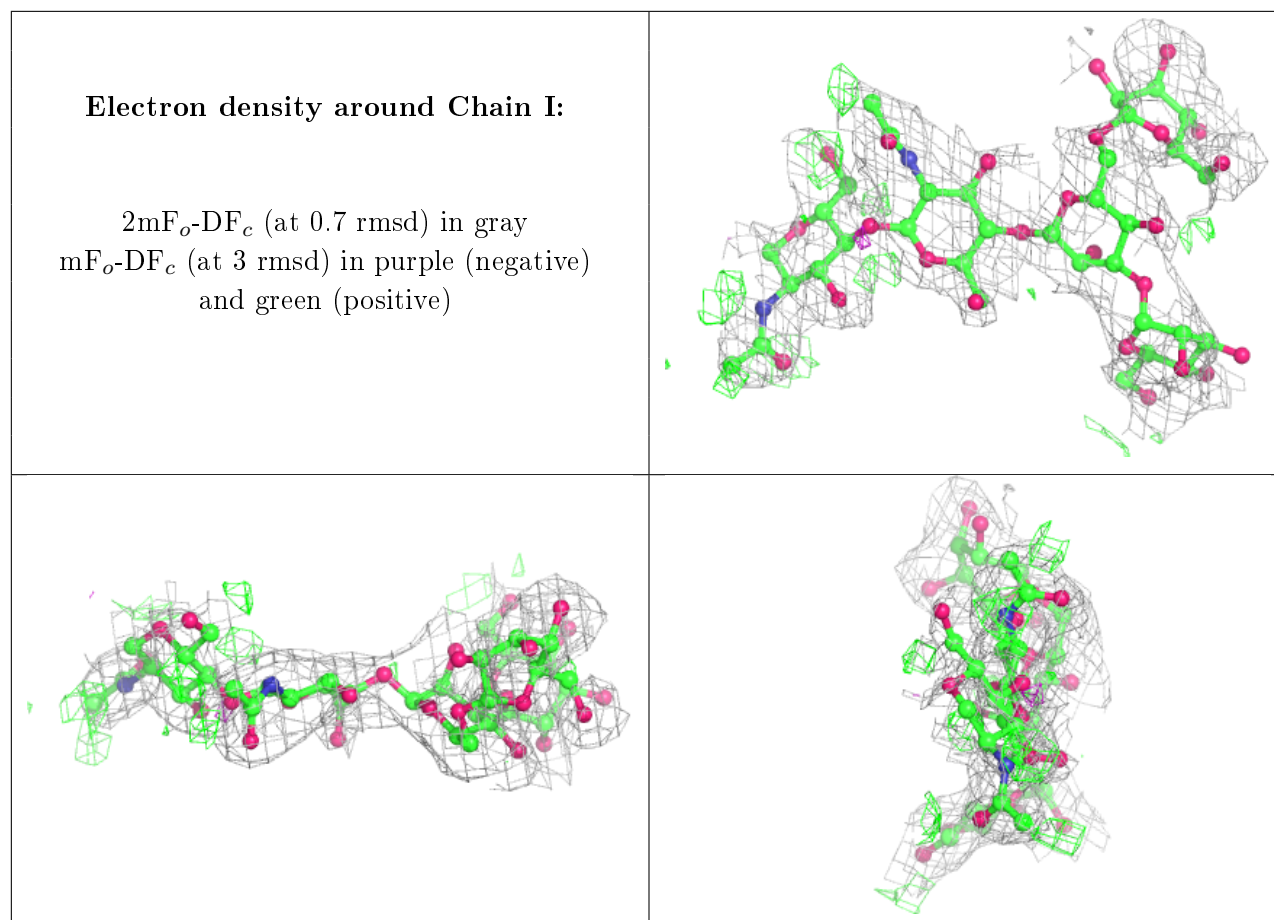

6.4 Ligands [i](#)

In the following table, the Atoms column lists the number of modelled atoms in the group and the number defined in the chemical component dictionary. The B-factors column lists the minimum, median, 95th percentile and maximum values of B factors of atoms in the group. The column labelled 'Q< 0.9' lists the number of atoms with occupancy less than 0.9.

Mol	Type	Chain	Res	Atoms	RSCC	RSR	B-factors(\AA^2)	Q<0.9
7	NAG	C	1610	14/15	0.62	0.30	98,106,126,128	0
7	NAG	G	501	14/15	0.64	0.29	83,94,100,104	0
8	PEG	G	518	7/7	0.65	0.30	54,65,77,78	0
7	NAG	G	511	14/15	0.68	0.32	74,113,117,117	0
7	NAG	G	507	14/15	0.69	0.34	88,99,110,114	0
7	NAG	G	508	14/15	0.74	0.45	100,113,118,123	0
7	NAG	C	1611	14/15	0.76	0.29	98,113,124,125	0
7	NAG	C	1603	14/15	0.77	0.30	98,110,120,123	0
7	NAG	C	1609	14/15	0.77	0.42	110,118,122,129	0
7	NAG	G	506	14/15	0.80	0.31	89,98,102,106	0
7	NAG	C	1602	14/15	0.81	0.18	70,96,101,102	0
9	CIT	C	1612	13/13	0.82	0.23	53,78,102,102	0

Continued on next page...

Continued from previous page...

Mol	Type	Chain	Res	Atoms	RSCC	RSR	B-factors(\AA^2)	Q<0.9
7	NAG	C	1601	14/15	0.84	0.27	108,119,131,132	0
7	NAG	G	505	14/15	0.86	0.21	65,75,90,91	0
7	NAG	G	504	14/15	0.88	0.17	70,77,86,94	0
10	EDO	C	1614	4/4	0.90	0.27	72,86,104,104	0
10	EDO	C	1613	4/4	0.91	0.24	61,76,92,95	0

The following is a graphical depiction of the model fit to experimental electron density of all instances of the Ligand of Interest. In addition, ligands with molecular weight > 250 and outliers as shown on the geometry validation Tables will also be included. Each fit is shown from different orientation to approximate a three-dimensional view.

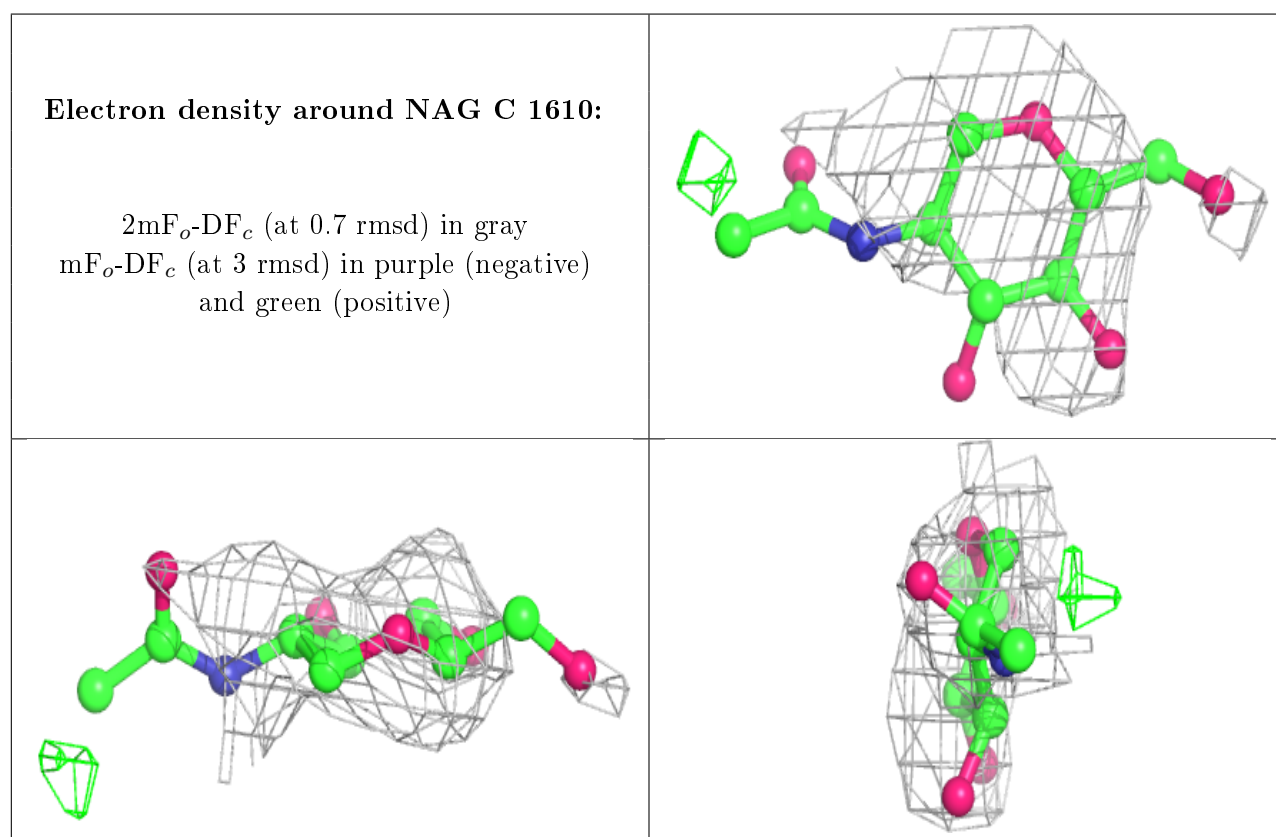

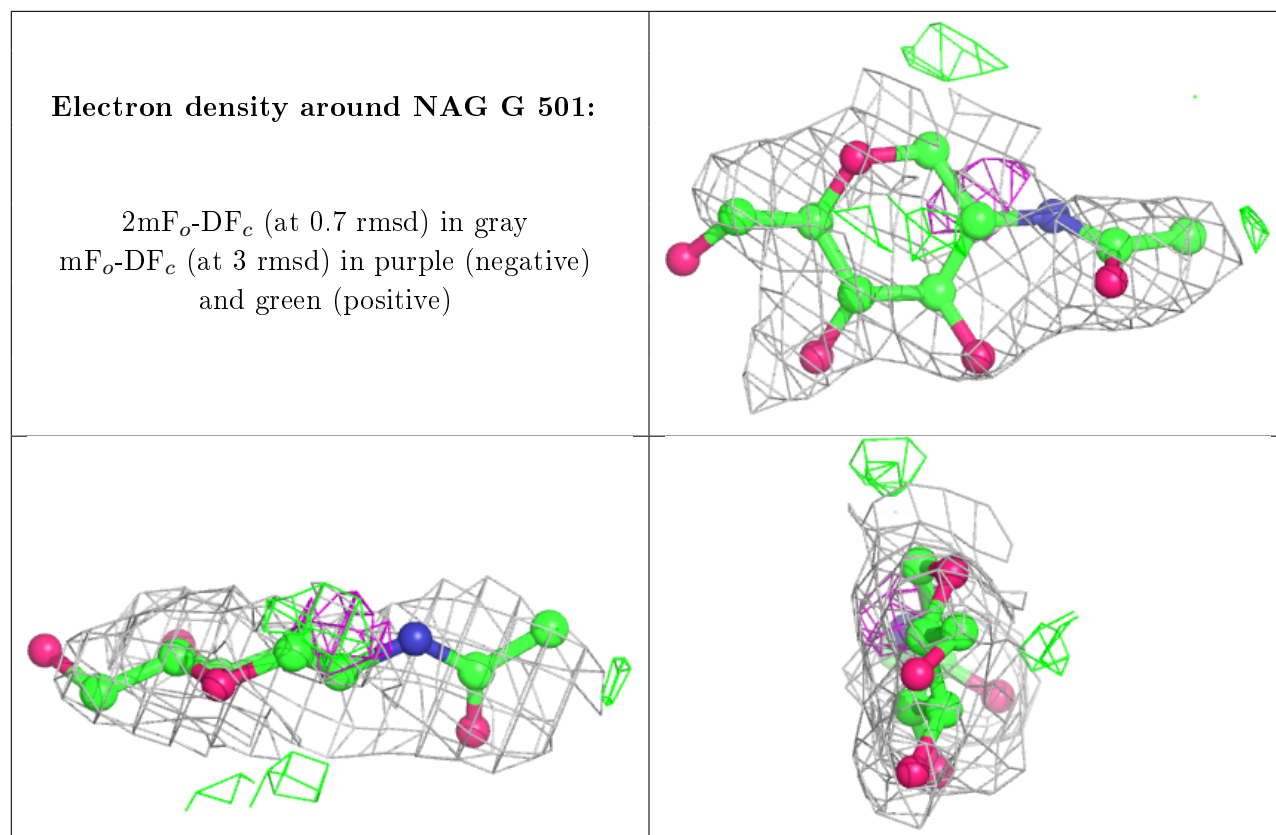

Electron density around NAG G 511:

$2mF_o-DF_c$ (at 0.7 rmsd) in gray
 mF_o-DF_c (at 3 rmsd) in purple (negative)
and green (positive)

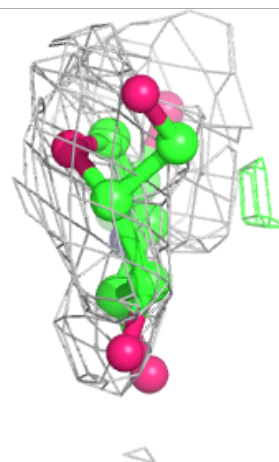
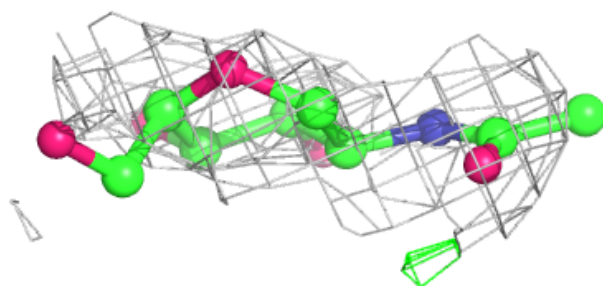
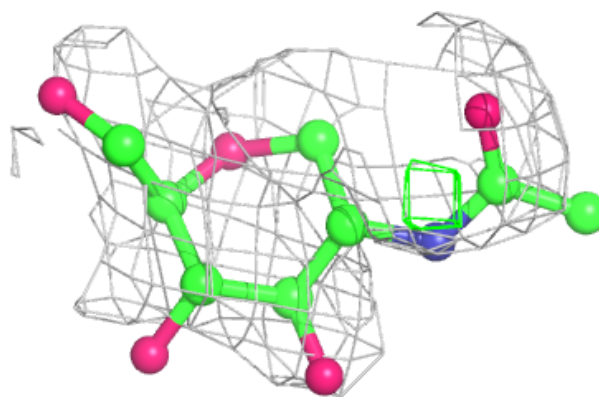

Electron density around NAG G 507:

$2mF_o-DF_c$ (at 0.7 rmsd) in gray
 mF_o-DF_c (at 3 rmsd) in purple (negative)
and green (positive)

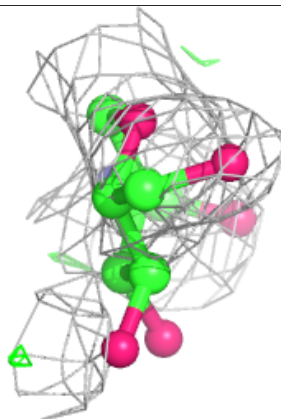
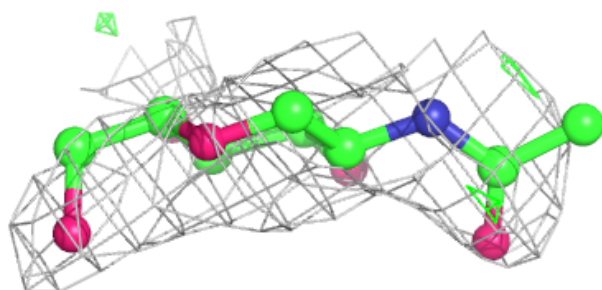
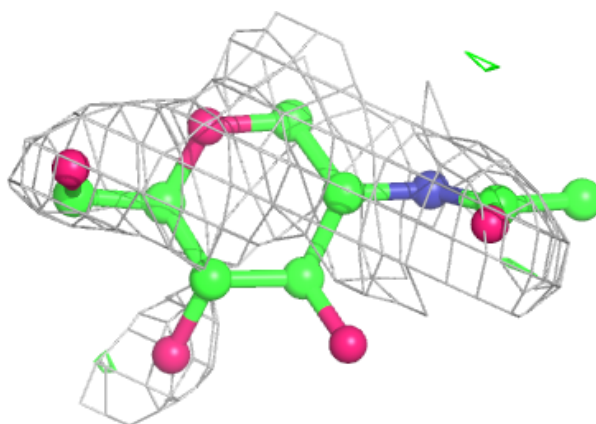
**Electron density around NAG G 508:**

$2mF_o-DF_c$ (at 0.7 rmsd) in gray
 mF_o-DF_c (at 3 rmsd) in purple (negative)
and green (positive)

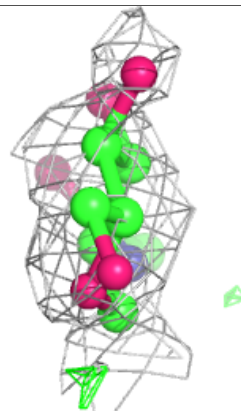
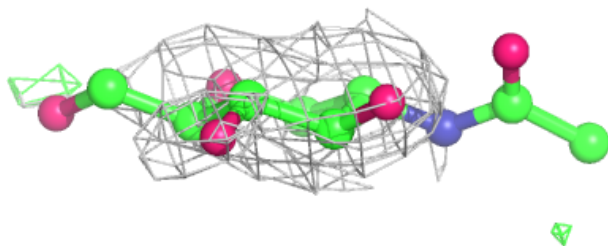
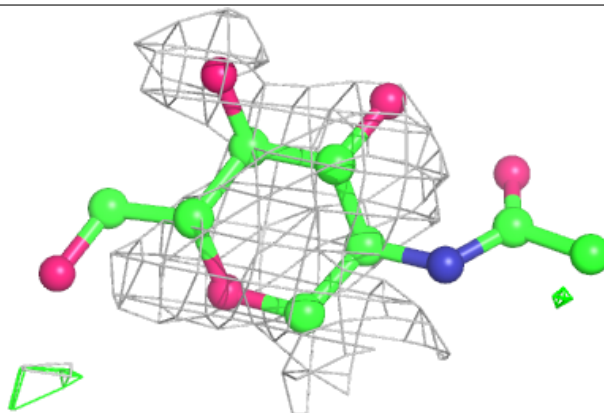

Electron density around NAG C 1611:

$2mF_o-DF_c$ (at 0.7 rmsd) in gray
 mF_o-DF_c (at 3 rmsd) in purple (negative)
and green (positive)

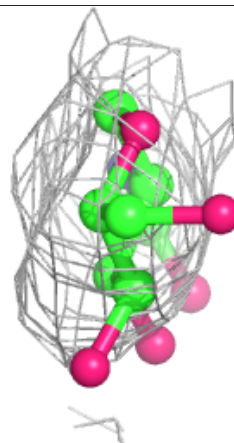
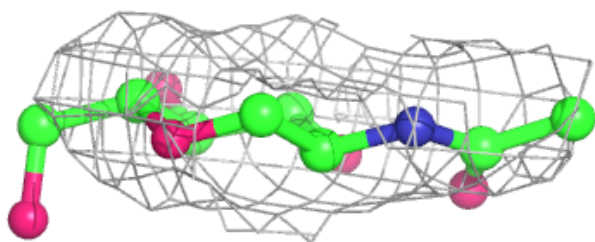
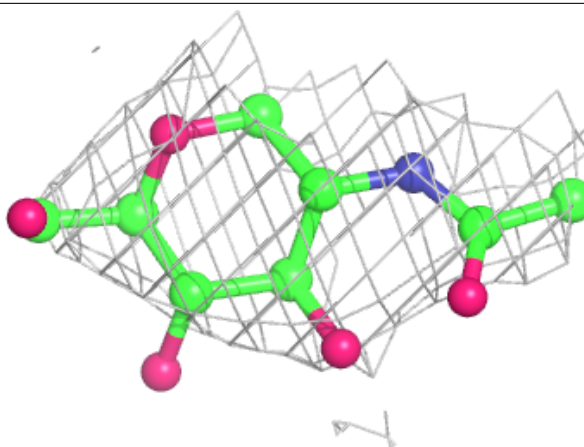
**Electron density around NAG C 1603:**

$2mF_o-DF_c$ (at 0.7 rmsd) in gray
 mF_o-DF_c (at 3 rmsd) in purple (negative)
and green (positive)

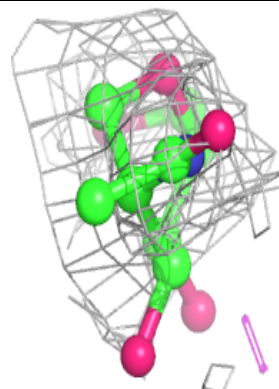
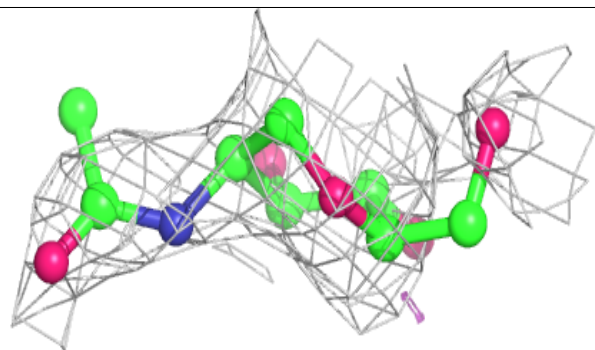
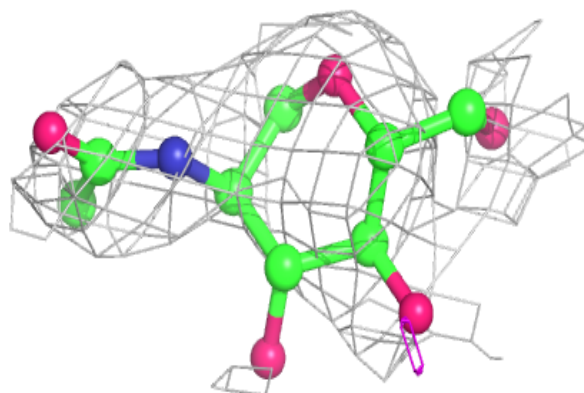

Electron density around NAG C 1609:

$2mF_o-DF_c$ (at 0.7 rmsd) in gray
 mF_o-DF_c (at 3 rmsd) in purple (negative)
and green (positive)

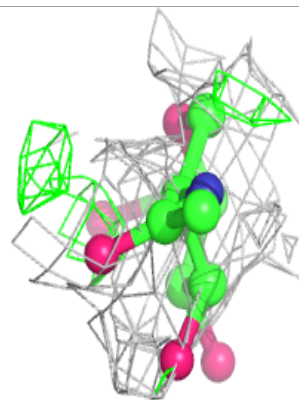
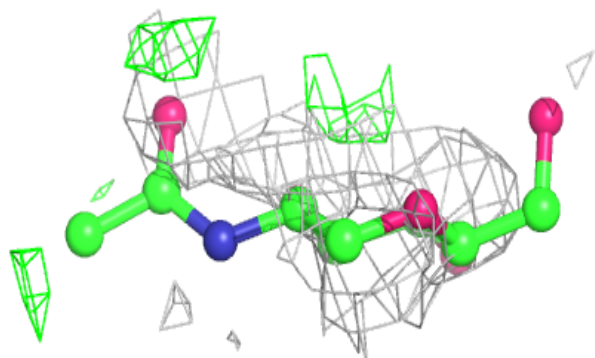
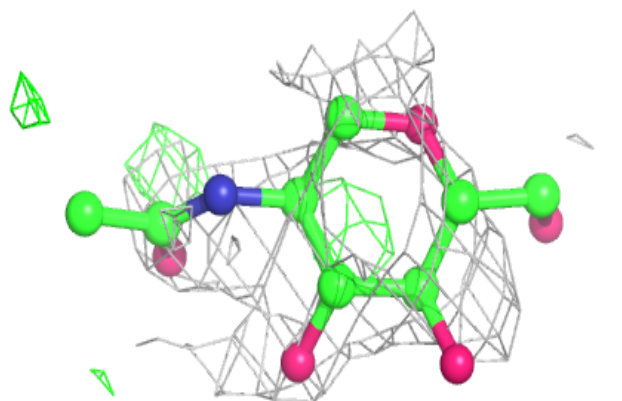
**Electron density around NAG G 506:**

$2mF_o-DF_c$ (at 0.7 rmsd) in gray
 mF_o-DF_c (at 3 rmsd) in purple (negative)
and green (positive)

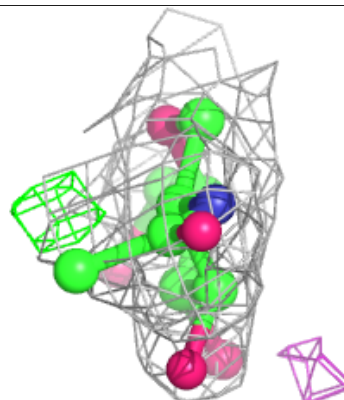
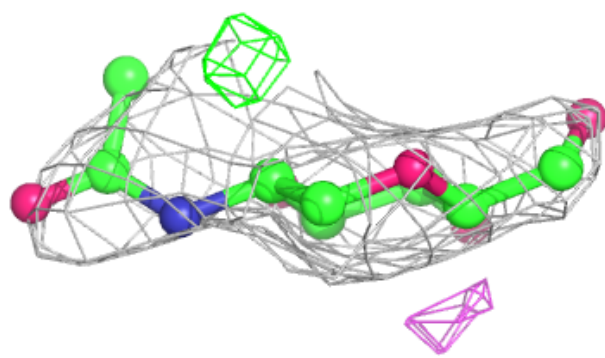
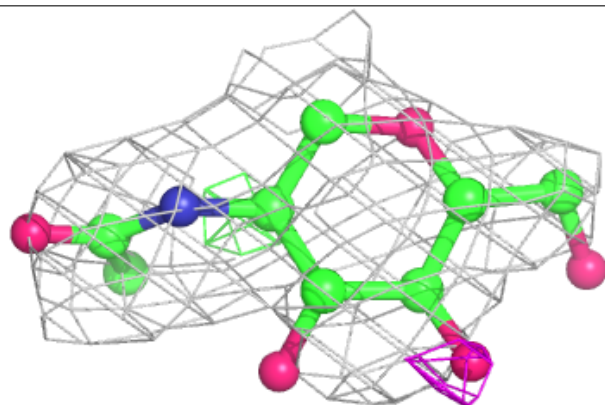

Electron density around NAG C 1602:

$2mF_o-DF_c$ (at 0.7 rmsd) in gray
 mF_o-DF_c (at 3 rmsd) in purple (negative)
and green (positive)

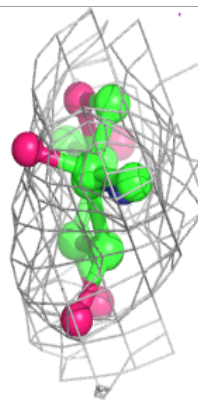
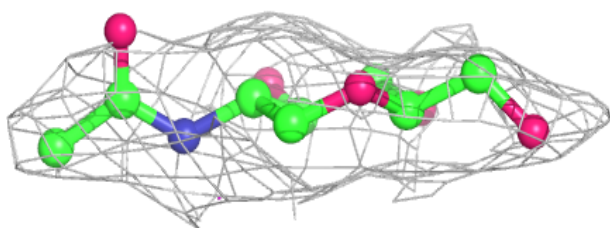
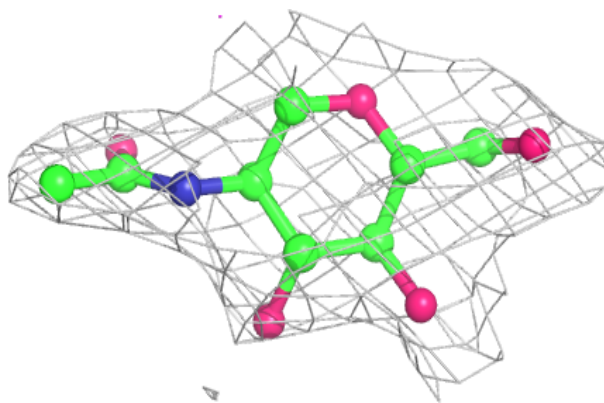
**Electron density around NAG C 1601:**

$2mF_o-DF_c$ (at 0.7 rmsd) in gray
 mF_o-DF_c (at 3 rmsd) in purple (negative)
and green (positive)

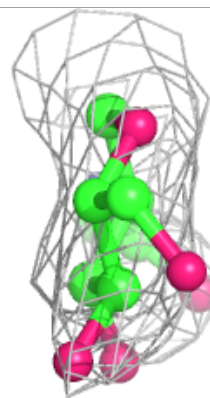
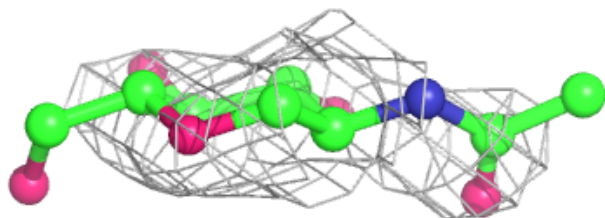
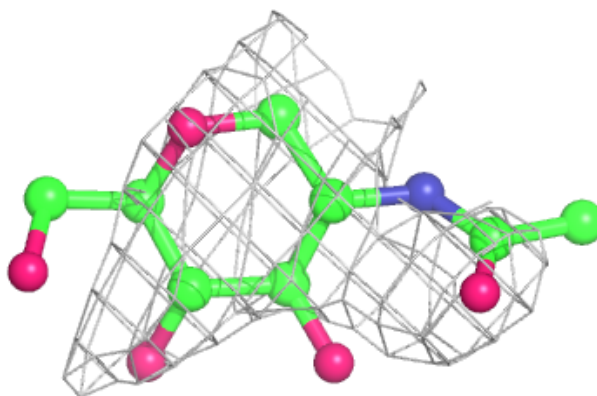

Electron density around NAG G 505:

$2mF_o-DF_c$ (at 0.7 rmsd) in gray
 mF_o-DF_c (at 3 rmsd) in purple (negative)
and green (positive)

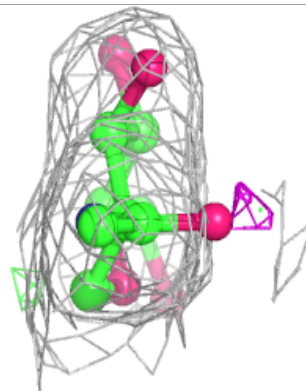
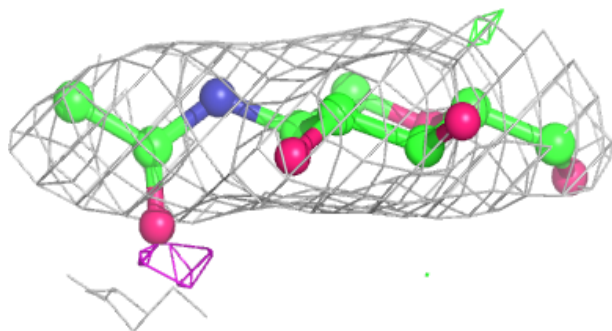
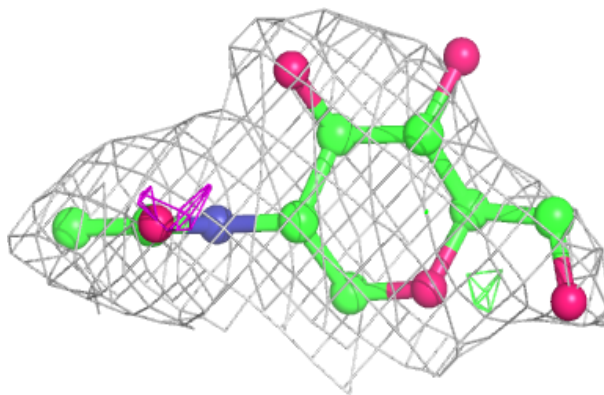
**Electron density around NAG G 504:**

$2mF_o-DF_c$ (at 0.7 rmsd) in gray
 mF_o-DF_c (at 3 rmsd) in purple (negative)
and green (positive)

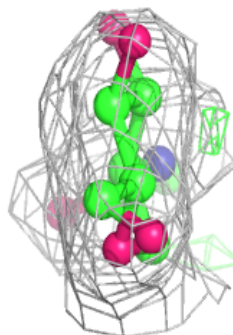
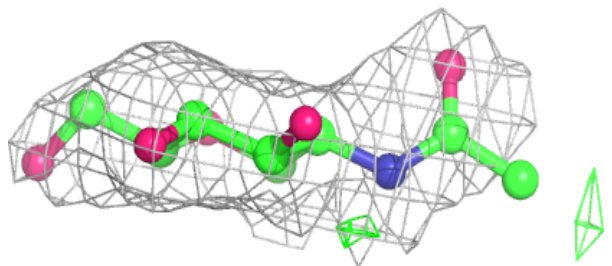
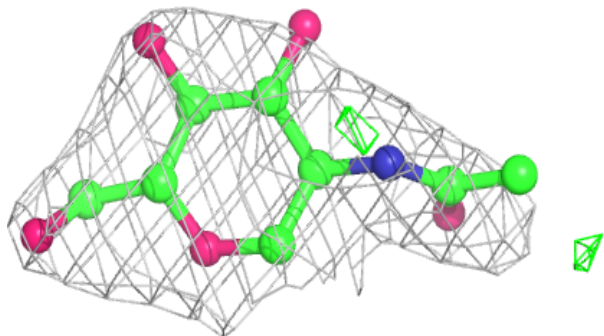

6.5 Other polymers

There are no such residues in this entry.