



## Full wwPDB EM Validation Report ⓘ

Feb 13, 2024 – 01:39 PM JST

PDB ID : 8IPA  
EMDB ID : EMD-35637  
Title : Wheat 80S ribosome stalled on AUG-Stop boron dependently with cycloheximide  
Authors : Yokoyama, T.; Tanaka, M.; Saito, H.; Nishimoto, M.; Tsuda, K.; Sotta, N.; Shigematsu, H.; Shirouzu, M.; Iwasaki, S.; Ito, T.; Fujiwara, T.  
Deposited on : 2023-03-14  
Resolution : 3.40 Å(reported)

This is a Full wwPDB EM Validation Report for a publicly released PDB entry.

We welcome your comments at [validation@mail.wwpdb.org](mailto:validation@mail.wwpdb.org)

A user guide is available at

<https://www.wwpdb.org/validation/2017/EMValidationReportHelp>

with specific help available everywhere you see the ⓘ symbol.

The types of validation reports are described at

<http://www.wwpdb.org/validation/2017/FAQs#types>.

---

The following versions of software and data (see [references ⓘ](#)) were used in the production of this report:

EMDB validation analysis : 0.0.1.dev70  
Mogul : 1.8.5 (274361), CSD as541be (2020)  
MolProbity : 4.02b-467  
buster-report : 1.1.7 (2018)  
Percentile statistics : 20191225.v01 (using entries in the PDB archive December 25th 2019)  
MapQ : 1.9.9  
Ideal geometry (proteins) : Engh & Huber (2001)  
Ideal geometry (DNA, RNA) : Parkinson et al. (1996)  
Validation Pipeline (wwPDB-VP) : 2.36

# 1 Overall quality at a glance i

The following experimental techniques were used to determine the structure:  
*ELECTRON MICROSCOPY*

The reported resolution of this entry is 3.40 Å.

Percentile scores (ranging between 0-100) for global validation metrics of the entry are shown in the following graphic. The table shows the number of entries on which the scores are based.

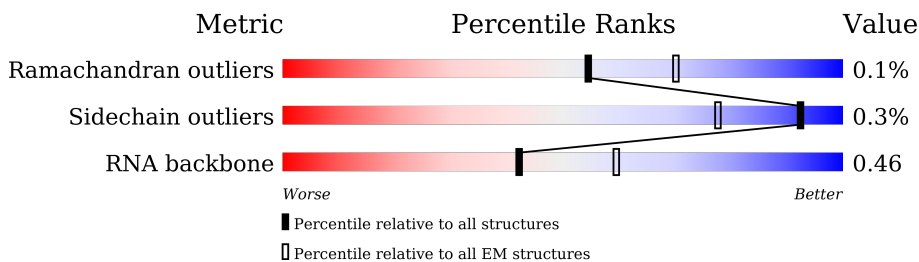

Metric	Whole archive (#Entries)	EM structures (#Entries)
Ramachandran outliers	154571	4023
Sidechain outliers	154315	3826
RNA backbone	4643	859

The table below summarises the geometric issues observed across the polymeric chains and their fit to the map. The red, orange, yellow and green segments of the bar indicate the fraction of residues that contain outliers for  $\geq 3$ , 2, 1 and 0 types of geometric quality criteria respectively. A grey segment represents the fraction of residues that are not modelled. The numeric value for each fraction is indicated below the corresponding segment, with a dot representing fractions  $\leq 5\%$ . The upper red bar (where present) indicates the fraction of residues that have poor fit to the EM map (all-atom inclusion  $< 40\%$ ). The numeric value is given above the bar.

Mol	Chain	Length	Quality of chain
1	aa	1810	
2	ba	137	
3	ca	225	
4	da	188	
5	ga	142	
6	ha	332	
7	ia	227	
8	ja	265	

Continued on next page...

Continued from previous page...

Mol	Chain	Length	Quality of chain
9	ka	200	63% 96%
10	la	149	55% 93% 6%
11	ma	127	50% 81% 19%
12	na	151	38% 80% 17%
13	oa	152	57% 88% 11%
14	pa	151	38% 99%
15	qa	143	67% 81% 17%
16	ra	155	44% 87% 13%
17	sa	154	47% 64% 35%
18	ta	108	63% 68% 29%
19	ua	86	48% 74% 26%
20	va	129	29% 95%
21	wa	56	27% 68% 30%
22	xa	86	42% 80% 19%
23	ya	62	29% 60% 37%
24	za	308	31% 66% 34%
25	bb	263	44% 79% 20%
26	cb	82	41% 93% 7%
27	db	156	19% 61% 39%
28	eb	195	39% 92% 7%
29	fb	274	26% 78% 22%
30	gb	250	48% 60% 40%
31	hb	192	59% 86% 12%
32	ib	159	33% 91% 9%
33	AA	258	41% 89% 11%

Continued on next page...

Continued from previous page...

Mol	Chain	Length	Quality of chain
34	BA	164	21% 95% 5%
35	CA	137	31% 99%
36	DA	261	11% 96%
37	EA	180	38% 89% 9%
38	FA	189	39% 97%
39	GA	140	24% 91% 8%
40	HA	204	6% 100%
41	IA	145	12% 99%
42	JA	187	17% 99%
43	KA	301	26% 91% 9%
44	LA	213	18% 80% 20%
45	MA	170	13% 90% 9%
46	NA	152	20% 76% 24%
47	OA	162	6% 37% 62%
48	PA	157	13% 82% 17%
49	QA	147	22% 97%
50	RA	112	24% 87% 12%
51	SA	123	18% 87% 13%
52	TA	133	12% 95% 5%
53	UA	93	86% 14%
54	VA	76	9% 66% 34%
55	WA	105	14% 93% 7%
56	XA	135	27% 98%
57	YA	178	20% 99%
58	ZA	130	49% 75% 22%

Continued on next page...

Continued from previous page...

Mol	Chain	Length	Quality of chain
59	AB	112	28% 88% 11%
60	BB	124	27% 96%
61	CB	244	21% 95%
62	DB	389	17% 97%
63	EB	404	28% 98%
64	FB	206	27% 99%
65	GB	92	20% 99%
66	HB	217	48% 94% 6%
67	IB	25	16% 100%
68	JB	129	9% 40% 60%
69	KB	208	23% 96%
70	LB	219	46% 98%
71	MB	112	13% 98%
72	NB	69	49% 97%
73	OB	60	13% 82% 17%
74	PB	119	8% 90% 9%
75	RB	3386	10% 70% 22% 7%
76	SB	160	12% 74% 26%
77	TB	120	85% 15%
78	al	7	57% 43%
79	bl	437	80% 99%
80	cl	75	57% 49% 39% 12%

## 2 Entry composition i

There are 83 unique types of molecules in this entry. The entry contains 201166 atoms, of which 0 are hydrogens and 0 are deuteriums.

In the tables below, the AltConf column contains the number of residues with at least one atom in alternate conformation and the Trace column contains the number of residues modelled with at most 2 atoms.

- Molecule 1 is a RNA chain called 18S ribosomal RNA.

Mol	Chain	Residues	Atoms					AltConf	Trace
			Total	C	N	O	P		
1	aa	1695	36156	16155	6463	11845	1693	0	0

There are 5 discrepancies between the modelled and reference sequences:

Chain	Residue	Modelled	Actual	Comment	Reference
aa	?	-	G	deletion	GB 2123606567
aa	1399	G	C	conflict	GB 2123606567
aa	1411	C	G	conflict	GB 2123606567
aa	1441	C	G	conflict	GB 2123606567
aa	1762	C	G	conflict	GB 2123606567

- Molecule 2 is a protein called 40S ribosomal protein eS24.

Mol	Chain	Residues	Atoms					AltConf	Trace
			Total	C	N	O	S		
2	ba	113	929	593	178	156	2	0	0

- Molecule 3 is a protein called 40S ribosomal protein eS8.

Mol	Chain	Residues	Atoms					AltConf	Trace
			Total	C	N	O	S		
3	ca	178	1443	891	291	257	4	0	0

- Molecule 4 is a protein called 40S ribosomal protein eS10.

Mol	Chain	Residues	Atoms					AltConf	Trace
			Total	C	N	O	S		
4	da	81	703	461	117	122	3	0	0

- Molecule 5 is a protein called 40S ribosomal protein uS12.

Mol	Chain	Residues	Atoms					AltConf	Trace
5	ga	138	Total	C	N	O	S	0	0
			1070	679	207	181	3		

- Molecule 6 is a protein called RACK1.

Mol	Chain	Residues	Atoms					AltConf	Trace
6	ha	322	Total	C	N	O	S	0	0
			2473	1555	429	478	11		

- Molecule 7 is a protein called 40S ribosomal protein uS3.

Mol	Chain	Residues	Atoms					AltConf	Trace
7	ia	213	Total	C	N	O	S	0	0
			1673	1061	303	300	9		

- Molecule 8 is a protein called 40S ribosomal protein eS4.

Mol	Chain	Residues	Atoms					AltConf	Trace
8	ja	261	Total	C	N	O	S	0	0
			2082	1325	388	362	7		

- Molecule 9 is a protein called 40S ribosomal protein uS7.

Mol	Chain	Residues	Atoms					AltConf	Trace
9	ka	193	Total	C	N	O	S	0	0
			1516	947	285	277	7		

- Molecule 10 is a protein called 40S ribosomal protein uS9.

Mol	Chain	Residues	Atoms					AltConf	Trace
10	la	140	Total	C	N	O	S	0	0
			1119	712	215	187	5		

- Molecule 11 is a protein called 40S ribosomal protein uS10.

Mol	Chain	Residues	Atoms					AltConf	Trace
11	ma	103	Total	C	N	O	S	0	0
			806	504	147	151	4		

- Molecule 12 is a protein called 40S ribosomal protein uS11.

Mol	Chain	Residues	Atoms					AltConf	Trace
			Total	C	N	O	S		
12	na	125	941	579	185	173	4	0	0

- Molecule 13 is a protein called 40S ribosomal protein uS13.

Mol	Chain	Residues	Atoms					AltConf	Trace
			Total	C	N	O	S		
13	oa	136	1114	695	220	193	6	0	0

- Molecule 14 is a protein called 40S ribosomal protein uS15.

Mol	Chain	Residues	Atoms					AltConf	Trace
			Total	C	N	O	S		
14	pa	150	1195	765	224	204	2	0	0

- Molecule 15 is a protein called 40S ribosomal protein eS17.

Mol	Chain	Residues	Atoms					AltConf	Trace
			Total	C	N	O	S		
15	qa	119	975	607	185	177	6	0	0

- Molecule 16 is a protein called 40S ribosomal protein eS19.

Mol	Chain	Residues	Atoms					AltConf	Trace
			Total	C	N	O	S		
16	ra	135	1065	672	200	189	4	0	0

- Molecule 17 is a protein called 40S ribosomal protein uS19.

Mol	Chain	Residues	Atoms					AltConf	Trace
			Total	C	N	O	S		
17	sa	100	807	518	151	133	5	0	0

- Molecule 18 is a protein called 40S ribosomal protein eS25.

Mol	Chain	Residues	Atoms					AltConf	Trace
			Total	C	N	O	S		
18	ta	77	618	387	116	113	2	0	0

- Molecule 19 is a protein called 40S ribosomal protein eS28.



Mol	Chain	Residues	Atoms					AltConf	Trace
19	ua	64	Total	C	N	O	S	0	0
			513	314	104	93	2		

- Molecule 20 is a protein called 40S ribosomal protein uS8.

Mol	Chain	Residues	Atoms					AltConf	Trace
20	va	128	Total	C	N	O	S	0	0
			1039	653	199	182	5		

- Molecule 21 is a protein called 40S ribosomal protein uS14.

Mol	Chain	Residues	Atoms					AltConf	Trace
21	wa	39	Total	C	N	O	S	0	0
			314	193	65	50	6		

- Molecule 22 is a protein called 40S ribosomal protein eS27.

Mol	Chain	Residues	Atoms					AltConf	Trace
22	xa	70	Total	C	N	O	S	0	0
			546	342	101	96	7		

- Molecule 23 is a protein called 40S ribosomal protein eS30.

Mol	Chain	Residues	Atoms				AltConf	Trace
23	ya	39	Total	C	N	O	0	0
			322	199	74	49		

- Molecule 24 is a protein called 40S ribosomal protein uS2.

Mol	Chain	Residues	Atoms					AltConf	Trace
24	za	202	Total	C	N	O	S	0	0
			1609	1018	291	289	11		

- Molecule 25 is a protein called 40S ribosomal protein eS1.

Mol	Chain	Residues	Atoms					AltConf	Trace
25	bb	211	Total	C	N	O	S	0	0
			1720	1096	311	304	9		

- Molecule 26 is a protein called 40S ribosomal protein eS21.

Mol	Chain	Residues	Atoms					AltConf	Trace
26	cb	76	Total	C	N	O	S	0	0
			596	368	111	114	3		

- Molecule 27 is a protein called 40S ribosomal protein eS26.

Mol	Chain	Residues	Atoms					AltConf	Trace
27	db	95	Total	C	N	O	S	0	0
			771	472	168	124	7		

- Molecule 28 is a protein called 40S ribosomal protein uS4.

Mol	Chain	Residues	Atoms					AltConf	Trace
28	eb	181	Total	C	N	O	S	0	0
			1493	945	298	246	4		

- Molecule 29 is a protein called 40S ribosomal protein uS5.

Mol	Chain	Residues	Atoms					AltConf	Trace
29	fb	214	Total	C	N	O	S	0	0
			1660	1070	294	287	9		

- Molecule 30 is a protein called 40S ribosomal protein eS6.

Mol	Chain	Residues	Atoms					AltConf	Trace
30	gb	151	Total	C	N	O	S	0	0
			1199	749	233	209	8		

- Molecule 31 is a protein called 40S ribosomal protein eS7.

Mol	Chain	Residues	Atoms					AltConf	Trace
31	hb	169	Total	C	N	O	S	0	0
			1389	889	255	243	2		

- Molecule 32 is a protein called 40S ribosomal protein uS17.

Mol	Chain	Residues	Atoms					AltConf	Trace
32	ib	145	Total	C	N	O	S	0	0
			1166	745	223	192	6		

- Molecule 33 is a protein called 40S ribosomal protein eL8.

Mol	Chain	Residues	Atoms					AltConf	Trace
33	AA	229	Total	C	N	O	S	0	0
			1847	1191	341	309	6		

- Molecule 34 is a protein called 60S ribosomal protein eL21.

Mol	Chain	Residues	Atoms					AltConf	Trace
34	BA	156	Total	C	N	O	S	0	0
			1256	795	246	212	3		

- Molecule 35 is a protein called 60S ribosomal protein eL27.

Mol	Chain	Residues	Atoms					AltConf	Trace
35	CA	136	Total	C	N	O	S	0	0
			1090	704	205	177	4		

- Molecule 36 is a protein called 60S ribosomal protein uL2.

Mol	Chain	Residues	Atoms					AltConf	Trace
36	DA	251	Total	C	N	O	S	0	0
			1919	1193	395	324	7		

- Molecule 37 is a protein called 60S ribosomal protein uL5.

Mol	Chain	Residues	Atoms					AltConf	Trace
37	EA	164	Total	C	N	O	S	0	0
			1332	841	248	235	8		

- Molecule 38 is a protein called 60S ribosomal protein uL6.

Mol	Chain	Residues	Atoms					AltConf	Trace
38	FA	185	Total	C	N	O	S	0	0
			1459	925	265	263	6		

- Molecule 39 is a protein called 60S ribosomal protein uL14.

Mol	Chain	Residues	Atoms					AltConf	Trace
39	GA	129	Total	C	N	O	S	0	0
			976	618	181	168	9		

- Molecule 40 is a protein called 60S ribosomal protein eL15.

Mol	Chain	Residues	Atoms					AltConf	Trace
40	HA	203	Total	C	N	O	S	0	0
			1720	1078	370	269	3		

- Molecule 41 is a protein called 60S ribosomal protein uL15.

Mol	Chain	Residues	Atoms					AltConf	Trace
41	IA	144	Total	C	N	O	S	0	0
			1123	720	218	181	4		

- Molecule 42 is a protein called 60S ribosomal protein eL18.

Mol	Chain	Residues	Atoms					AltConf	Trace
42	JA	186	Total	C	N	O	S	0	0
			1487	938	296	248	5		

- Molecule 43 is a protein called 60S ribosomal protein uL18.

Mol	Chain	Residues	Atoms					AltConf	Trace
43	KA	273	Total	C	N	O	S	0	0
			2209	1390	406	408	5		

- Molecule 44 is a protein called 60S ribosomal protein eL19.

Mol	Chain	Residues	Atoms					AltConf	Trace
44	LA	170	Total	C	N	O	S	0	0
			1414	880	295	231	8		

- Molecule 45 is a protein called 60S ribosomal protein uL22.

Mol	Chain	Residues	Atoms					AltConf	Trace
45	MA	155	Total	C	N	O	S	0	0
			1253	780	247	221	5		

- Molecule 46 is a protein called 60S ribosomal protein uL23.

Mol	Chain	Residues	Atoms					AltConf	Trace
46	NA	116	Total	C	N	O	S	0	0
			935	600	165	168	2		

- Molecule 47 is a protein called 60S ribosomal protein eL24.

Mol	Chain	Residues	Atoms					AltConf	Trace
47	OA	61	Total	C	N	O	S	0	0
			517	335	99	79	4		

- Molecule 48 is a protein called 60S ribosomal protein uL24.

Mol	Chain	Residues	Atoms					AltConf	Trace
48	PA	130	Total	C	N	O	S	0	0
			1054	651	223	177	3		

- Molecule 49 is a protein called 60S ribosomal protein eL28.

Mol	Chain	Residues	Atoms					AltConf	Trace
49	QA	142	Total	C	N	O	S	0	0
			1125	711	207	203	4		

- Molecule 50 is a protein called 60S ribosomal protein eL30.

Mol	Chain	Residues	Atoms					AltConf	Trace
50	RA	98	Total	C	N	O	S	0	0
			757	480	131	140	6		

- Molecule 51 is a protein called 60S ribosomal protein eL31.

Mol	Chain	Residues	Atoms					AltConf	Trace
51	SA	107	Total	C	N	O	S	0	0
			863	540	167	154	2		

- Molecule 52 is a protein called 60S ribosomal protein eL32.

Mol	Chain	Residues	Atoms					AltConf	Trace
52	TA	126	Total	C	N	O	S	0	0
			1042	662	207	168	5		

- Molecule 53 is a protein called 60S ribosomal protein eL37.

Mol	Chain	Residues	Atoms					AltConf	Trace
53	UA	80	Total	C	N	O	S	0	0
			656	402	144	104	6		

- Molecule 54 is a protein called 60S ribosomal protein eL39.

Mol	Chain	Residues	Atoms					AltConf	Trace
54	VA	50	Total	C	N	O	S	0	0
			452	286	99	66	1		

- Molecule 55 is a protein called 60S ribosomal protein eL42.

Mol	Chain	Residues	Atoms					AltConf	Trace
55	WA	98	Total	C	N	O	S	0	0
			794	498	157	134	5		

- Molecule 56 is a protein called 60S ribosomal protein eL14.

Mol	Chain	Residues	Atoms					AltConf	Trace
56	XA	132	Total	C	N	O	S	0	0
			1066	684	196	181	5		

- Molecule 57 is a protein called 60S ribosomal protein eL20.

Mol	Chain	Residues	Atoms					AltConf	Trace
57	YA	177	Total	C	N	O	S	0	0
			1496	963	275	250	8		

- Molecule 58 is a protein called 60S ribosomal protein eL22.

Mol	Chain	Residues	Atoms					AltConf	Trace
58	ZA	101	Total	C	N	O	S	0	0
			814	520	144	148	2		

- Molecule 59 is a protein called 60S ribosomal protein eL36.

Mol	Chain	Residues	Atoms					AltConf	Trace
59	AB	100	Total	C	N	O	S	0	0
			803	505	166	130	2		

- Molecule 60 is a protein called 60S ribosomal protein uL29.

Mol	Chain	Residues	Atoms				AltConf	Trace
60	BB	119	Total	C	N	O	0	0
			979	617	196	166		

- Molecule 61 is a protein called 60S ribosomal protein uL30.

Mol	Chain	Residues	Atoms					AltConf	Trace
61	CB	234	Total	C	N	O	S	0	0
			1917	1230	357	325	5		

- Molecule 62 is a protein called 60S ribosomal protein uL3.

Mol	Chain	Residues	Atoms					AltConf	Trace
62	DB	384	Total	C	N	O	S	0	0
			3099	1972	575	535	17		

- Molecule 63 is a protein called 60S ribosomal protein uL4.

Mol	Chain	Residues	Atoms					AltConf	Trace
63	EB	399	Total	C	N	O	S	0	0
			3075	1934	590	540	11		

- Molecule 64 is a protein called 60S ribosomal protein uL13.

Mol	Chain	Residues	Atoms					AltConf	Trace
64	FB	205	Total	C	N	O	S	0	0
			1641	1040	319	272	10		

- Molecule 65 is a protein called 60S ribosomal protein eL43.

Mol	Chain	Residues	Atoms					AltConf	Trace
65	GB	91	Total	C	N	O	S	0	0
			707	442	136	123	6		

- Molecule 66 is a protein called 60S ribosomal protein uL16.

Mol	Chain	Residues	Atoms					AltConf	Trace
66	HB	205	Total	C	N	O	S	0	0
			1635	1034	321	271	9		

- Molecule 67 is a protein called 60S ribosomal protein eL41.

Mol	Chain	Residues	Atoms					AltConf	Trace
67	IB	25	Total	C	N	O	S	0	0
			237	145	62	27	3		

- Molecule 68 is a protein called 60S ribosomal protein eL40.

Mol	Chain	Residues	Atoms					AltConf	Trace
68	JB	51	Total	C	N	O	S	0	0
			420	262	88	65	5		

- Molecule 69 is a protein called 60S ribosomal protein eL13.

Mol	Chain	Residues	Atoms					AltConf	Trace
69	KB	205	Total	C	N	O	S	0	0
			1670	1045	334	285	6		

- Molecule 70 is a protein called 60S ribosomal protein eL6.

Mol	Chain	Residues	Atoms					AltConf	Trace
70	LB	215	Total	C	N	O	S	0	0
			1703	1088	310	302	3		

- Molecule 71 is a protein called 60S ribosomal protein eL33.

Mol	Chain	Residues	Atoms					AltConf	Trace
71	MB	110	Total	C	N	O	S	0	0
			875	551	168	152	4		

- Molecule 72 is a protein called 60S ribosomal protein eL38.

Mol	Chain	Residues	Atoms					AltConf	Trace
72	NB	68	Total	C	N	O	S	0	0
			557	354	105	96	2		

There are 3 discrepancies between the modelled and reference sequences:

Chain	Residue	Modelled	Actual	Comment	Reference
NB	48	PHE	HIS	conflict	UNP A0A1D5W6Q2
NB	50	ALA	THR	conflict	UNP A0A1D5W6Q2
NB	65	SER	ASN	conflict	UNP A0A1D5W6Q2

- Molecule 73 is a protein called 60S ribosomal protein eL29.

Mol	Chain	Residues	Atoms					AltConf	Trace
73	OB	50	Total	C	N	O	S	0	0
			416	254	93	68	1		

- Molecule 74 is a protein called 60S ribosomal protein eL34.



Mol	Chain	Residues	Atoms					AltConf	Trace
74	PB	108	Total	C	N	O	S	0	0
			879	555	179	144	1		

- Molecule 75 is a RNA chain called 60S ribosomal RNA.

Mol	Chain	Residues	Atoms					AltConf	Trace
75	RB	3147	Total	C	N	O	P	0	0
			67383	30051	12300	21886	3146		

- Molecule 76 is a RNA chain called 5.8S ribosomal RNA.

Mol	Chain	Residues	Atoms					AltConf	Trace
76	SB	160	Total	C	N	O	P	0	0
			3408	1522	614	1113	159		

- Molecule 77 is a RNA chain called 5S ribosomal RNA.

Mol	Chain	Residues	Atoms					AltConf	Trace
77	TB	120	Total	C	N	O	P	0	0
			2561	1144	461	837	119		

- Molecule 78 is a RNA chain called mRNA.

Mol	Chain	Residues	Atoms					AltConf	Trace
78	al	7	Total	C	N	O	P	0	0
			147	68	29	44	6		

- Molecule 79 is a protein called eukaryotic release factor 1.

Mol	Chain	Residues	Atoms					AltConf	Trace
79	bl	437	Total	C	N	O	S	0	0
			3446	2168	589	675	14		

- Molecule 80 is a RNA chain called tRNAi.

Mol	Chain	Residues	Atoms						AltConf	Trace
80	cl	75	Total	C	N	O	P	S	0	0
			1622	730	298	518	75	1		

- Molecule 81 is MAGNESIUM ION (three-letter code: MG) (formula: Mg).

Mol	Chain	Residues	Atoms	AltConf
81	aa	73	Total Mg 73 73	0
81	BA	1	Total Mg 1 1	0
81	DA	2	Total Mg 2 2	0
81	GA	1	Total Mg 1 1	0
81	HA	1	Total Mg 1 1	0
81	IA	1	Total Mg 1 1	0
81	JA	1	Total Mg 1 1	0
81	DB	2	Total Mg 2 2	0
81	KB	1	Total Mg 1 1	0
81	OB	1	Total Mg 1 1	0
81	PB	1	Total Mg 1 1	0
81	RB	196	Total Mg 196 196	0
81	TB	1	Total Mg 1 1	0
81	cl	2	Total Mg 2 2	0

- Molecule 82 is ZINC ION (three-letter code: ZN) (formula: Zn).

Mol	Chain	Residues	Atoms	AltConf
82	wa	1	Total Zn 1 1	0
82	db	1	Total Zn 1 1	0
82	WA	1	Total Zn 1 1	0
82	GB	1	Total Zn 1 1	0

- Molecule 83 is 4-{(2R)-2-[(1S,3S,5S)-3,5-dimethyl-2-oxocyclohexyl]-2-hydroxyethyl}piperidine-2,6-dione (three-letter code: 3HE) (formula: C<sub>15</sub>H<sub>23</sub>NO<sub>4</sub>).

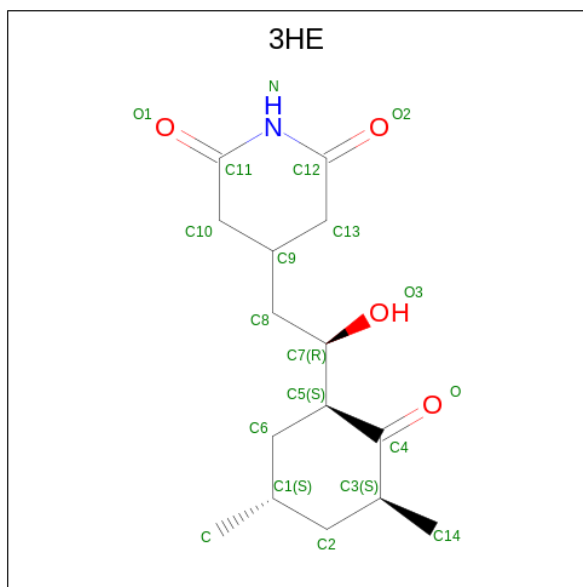

Mol	Chain	Residues	Atoms				AltConf
			Total	C	N	O	
83	RB	1	20	15	1	4	0



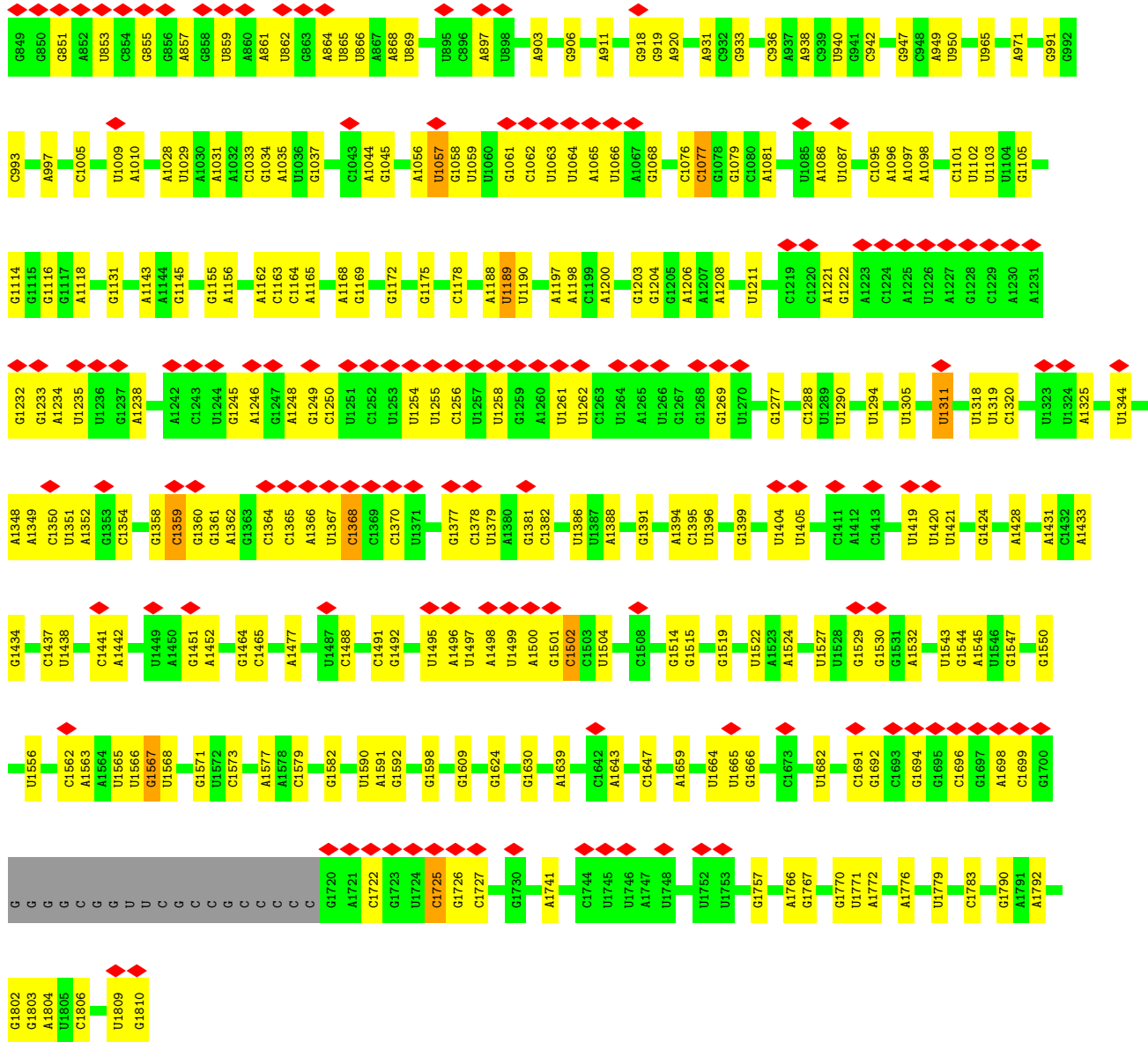

• Molecule 2: 40S ribosomal protein eS24

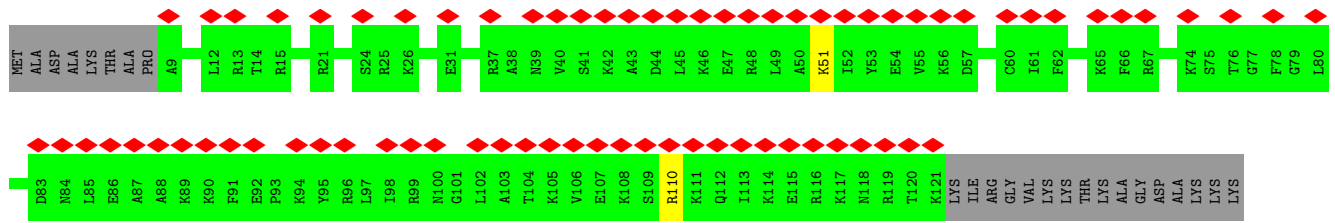
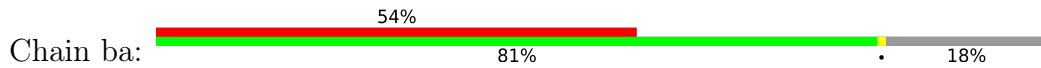

• Molecule 3: 40S ribosomal protein eS8

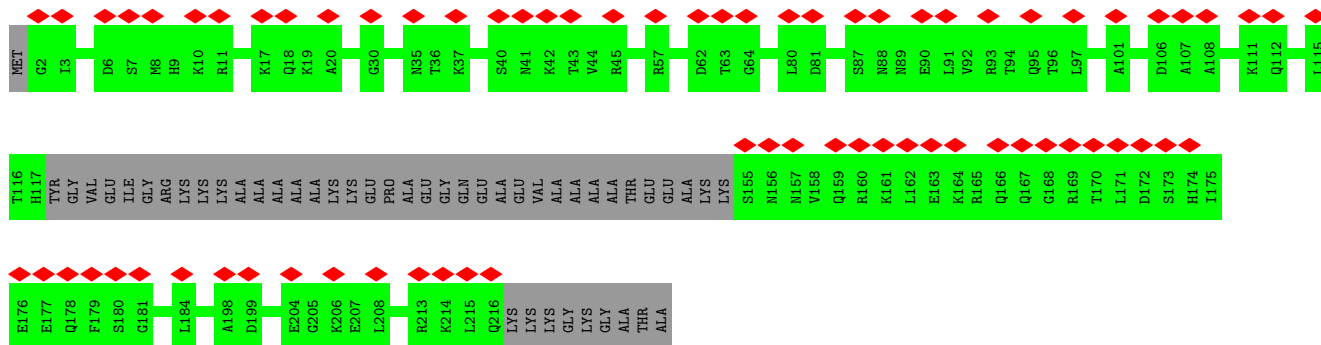

• Molecule 4: 40S ribosomal protein eS10

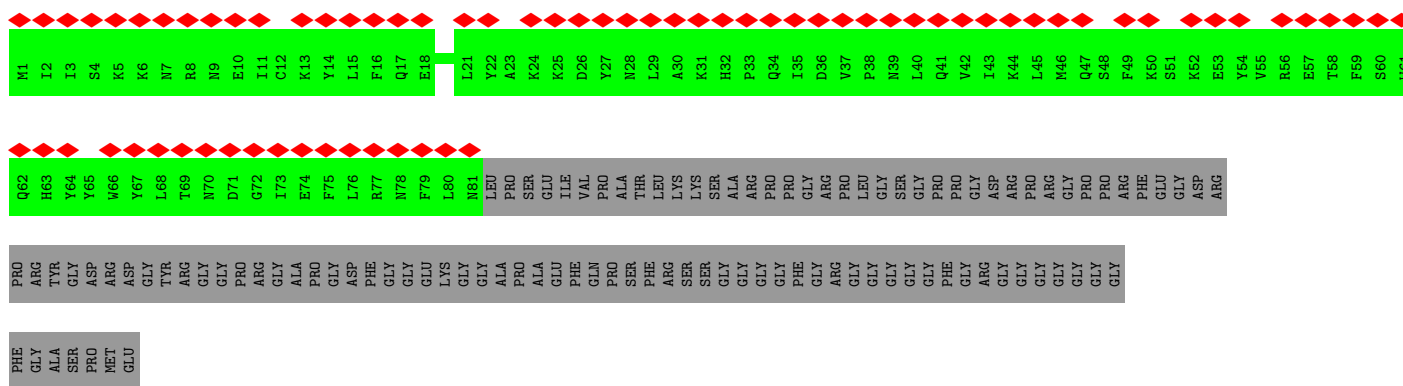

• Molecule 5: 40S ribosomal protein uS12

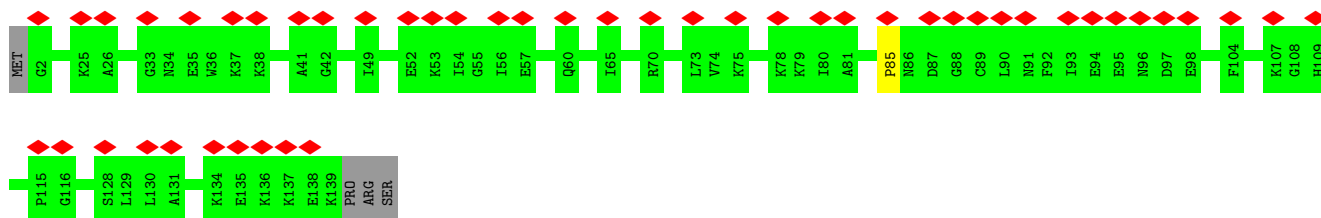

• Molecule 6: RACK1

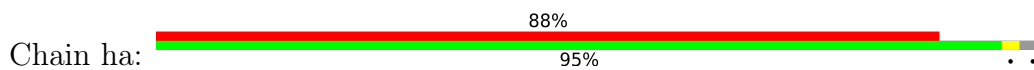

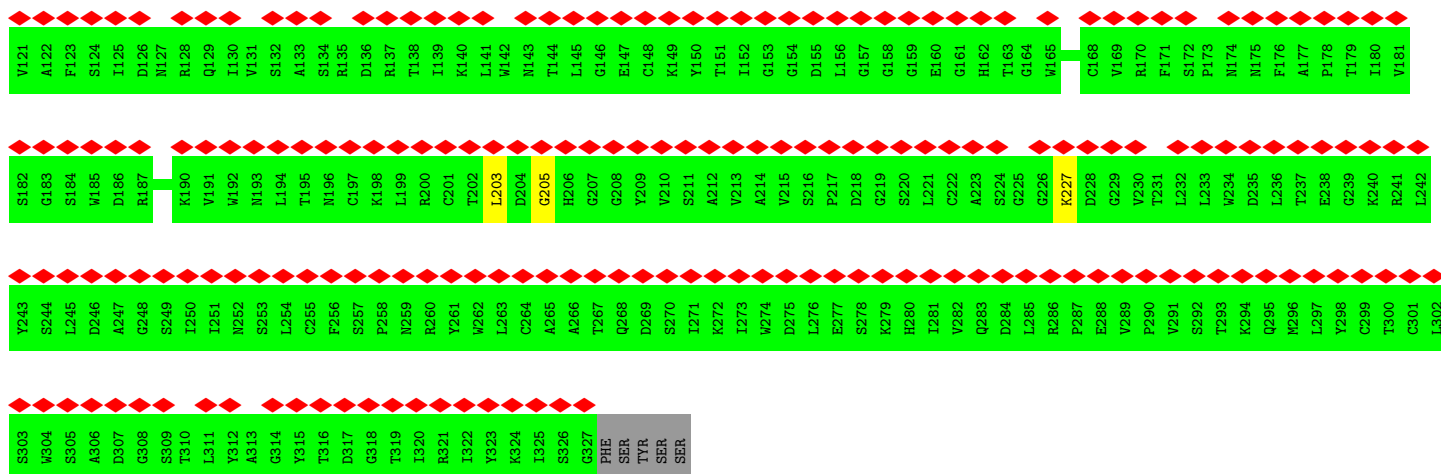

• Molecule 7: 40S ribosomal protein uS3



• Molecule 8: 40S ribosomal protein eS4

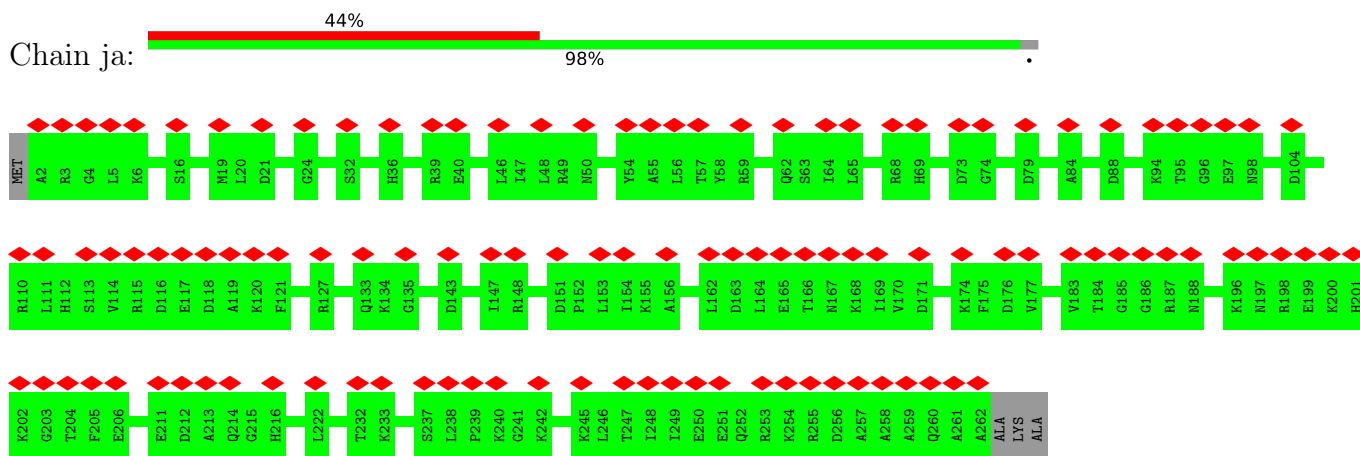

• Molecule 9: 40S ribosomal protein uS7



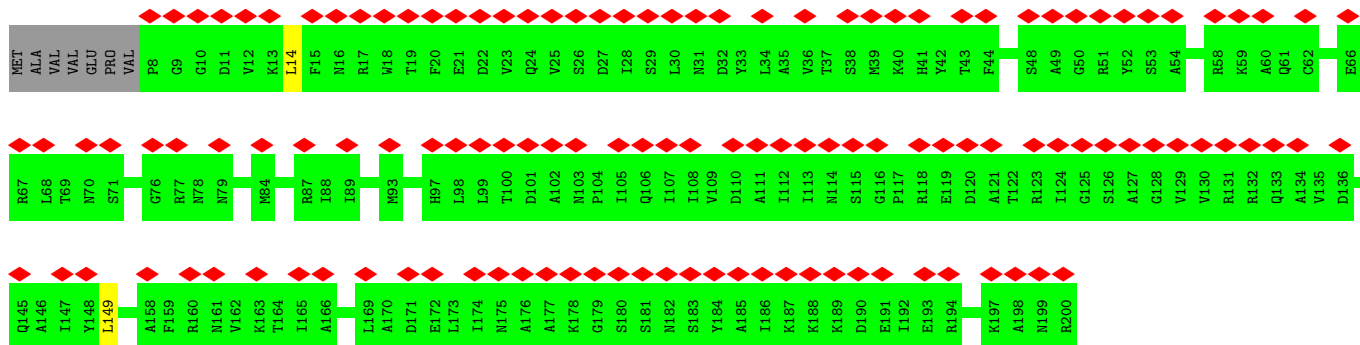

• Molecule 10: 40S ribosomal protein uS9

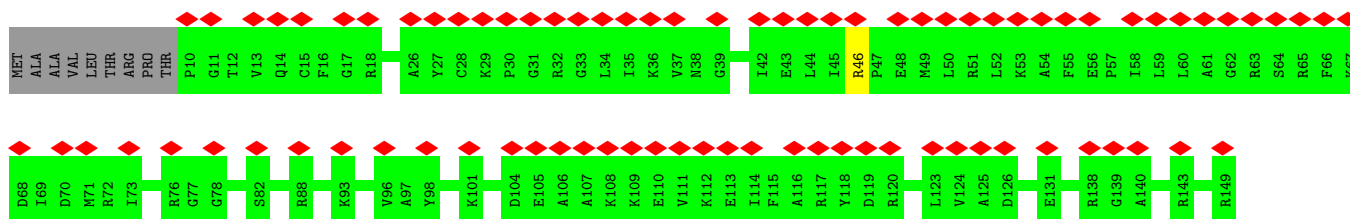

• Molecule 11: 40S ribosomal protein uS10

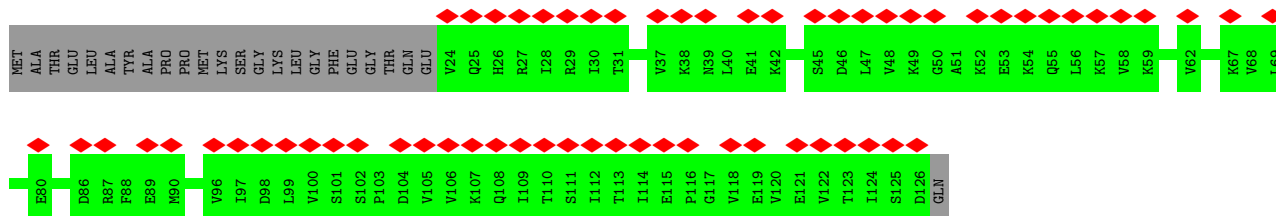
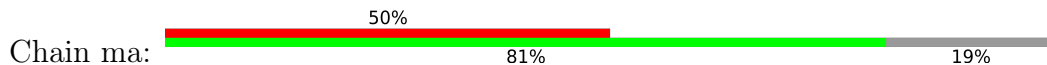

• Molecule 12: 40S ribosomal protein uS11

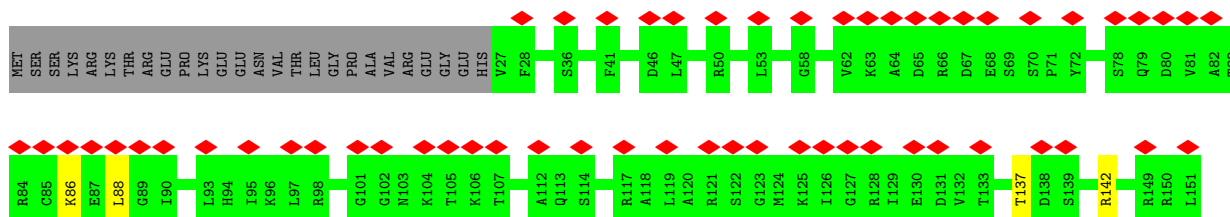
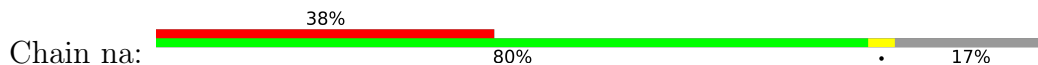

• Molecule 13: 40S ribosomal protein uS13

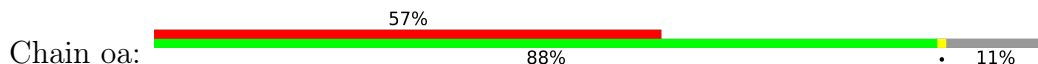



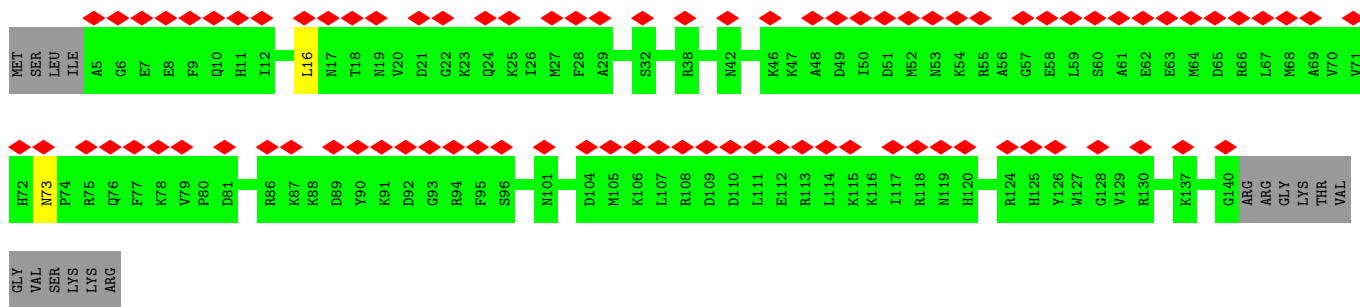

• Molecule 14: 40S ribosomal protein uS15

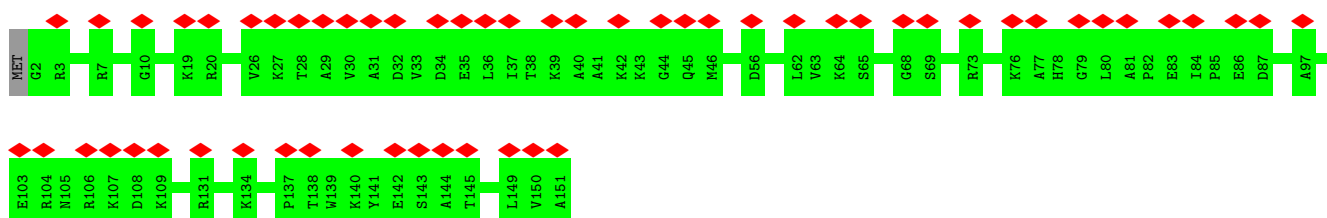
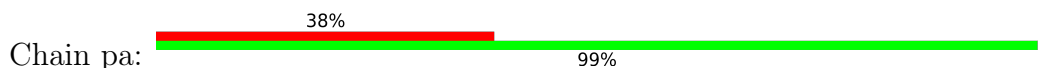

• Molecule 15: 40S ribosomal protein eS17

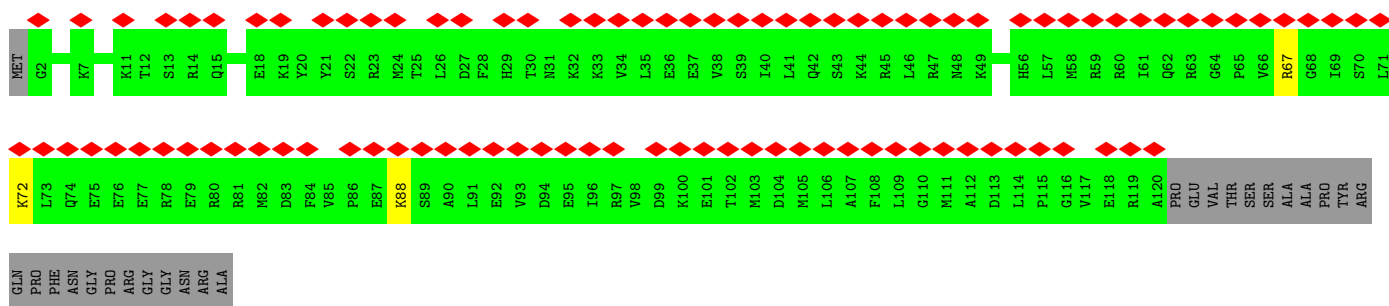
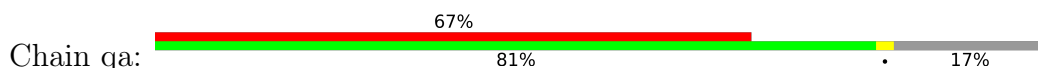

• Molecule 16: 40S ribosomal protein eS19

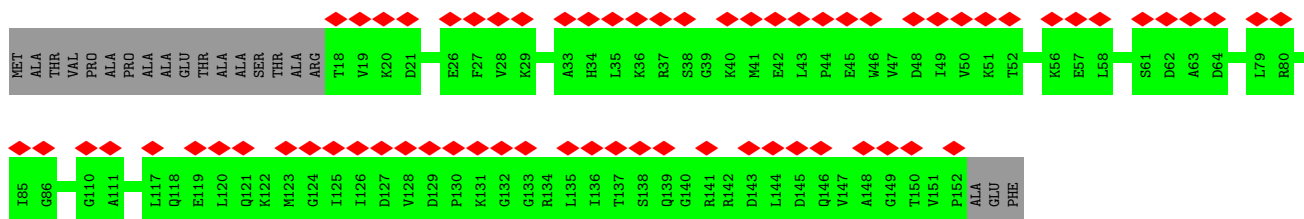
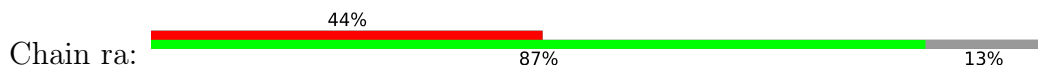

• Molecule 17: 40S ribosomal protein uS19



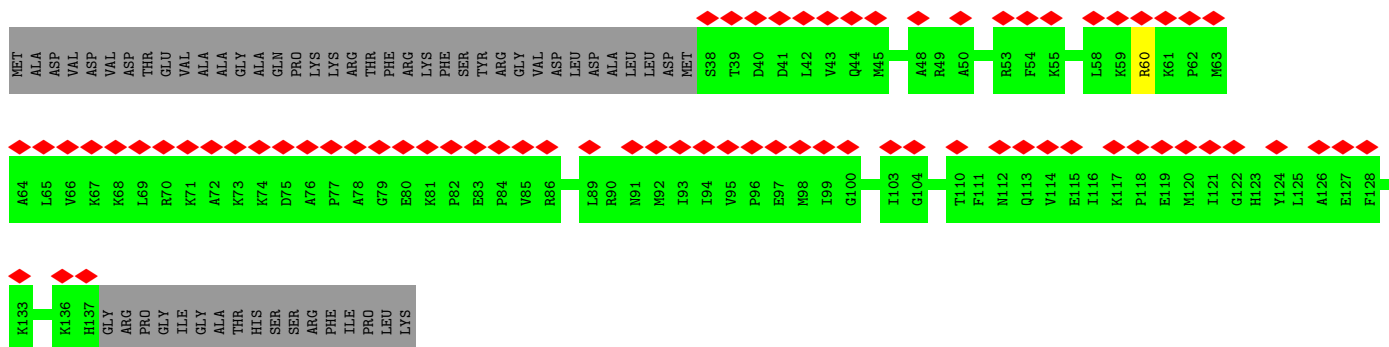

• Molecule 18: 40S ribosomal protein eS25

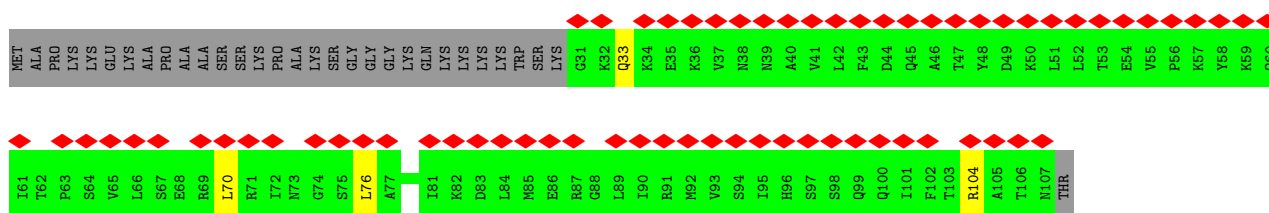

• Molecule 19: 40S ribosomal protein eS28

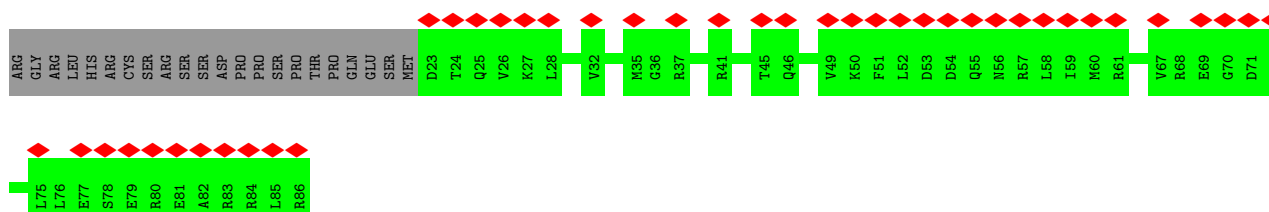
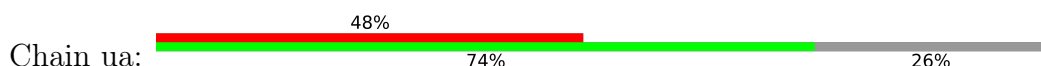

• Molecule 20: 40S ribosomal protein uS8

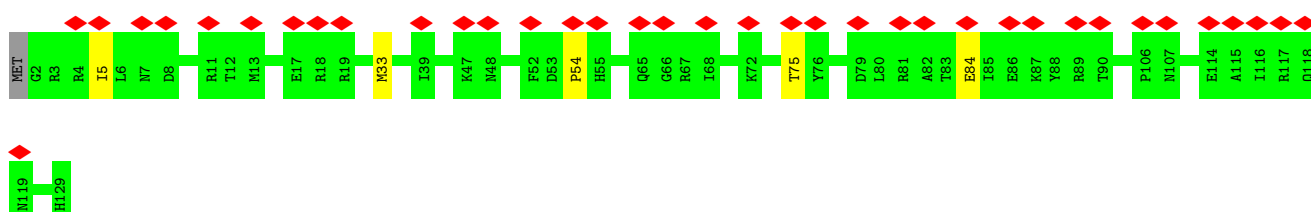

• Molecule 21: 40S ribosomal protein uS14







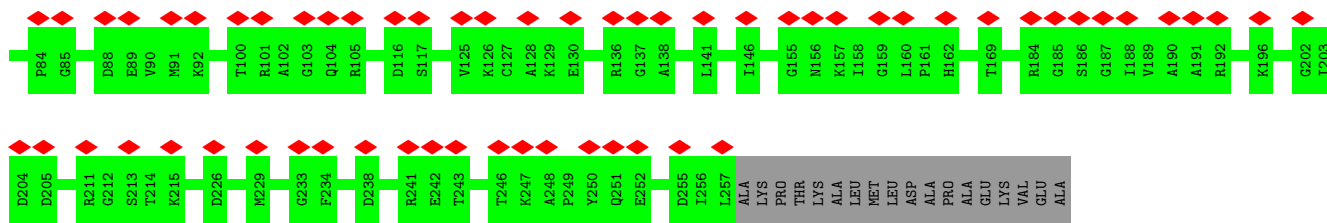

• Molecule 30: 40S ribosomal protein eS6

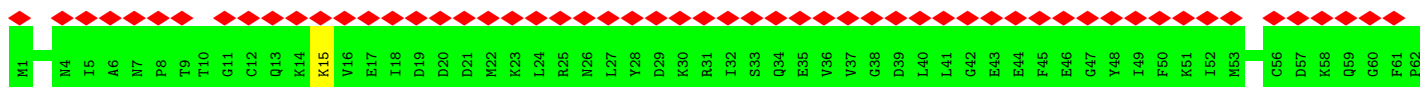

• Molecule 31: 40S ribosomal protein eS7

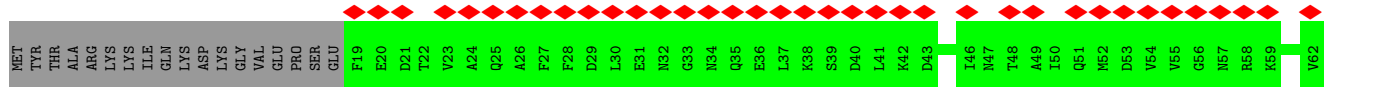
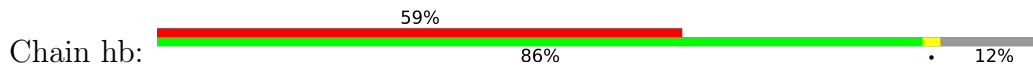

• Molecule 32: 40S ribosomal protein uS17

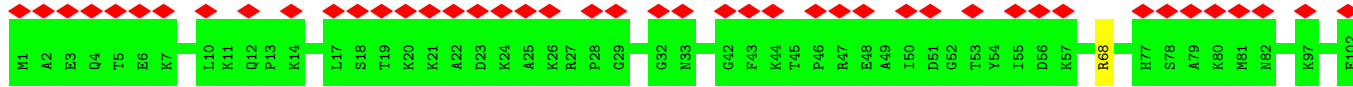
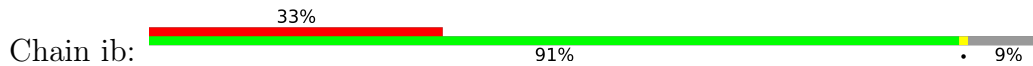

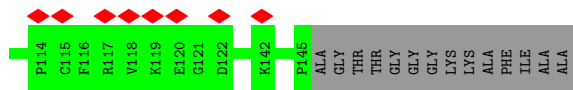

• Molecule 33: 40S ribosomal protein eL8

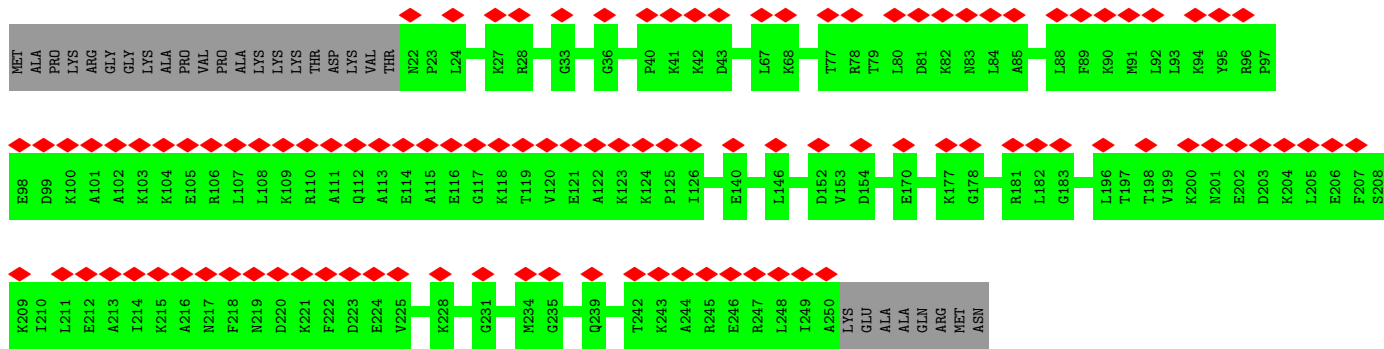
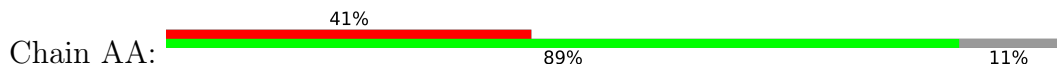

• Molecule 34: 60S ribosomal protein eL21

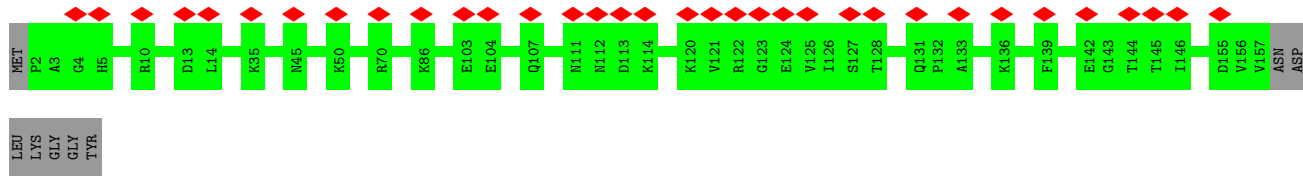

• Molecule 35: 60S ribosomal protein eL27

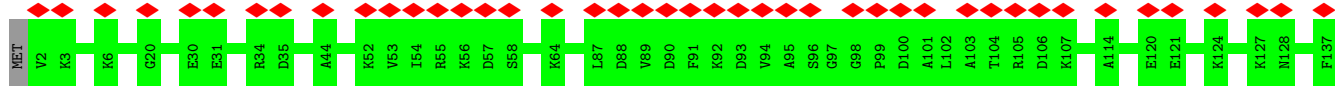

• Molecule 36: 60S ribosomal protein uL2

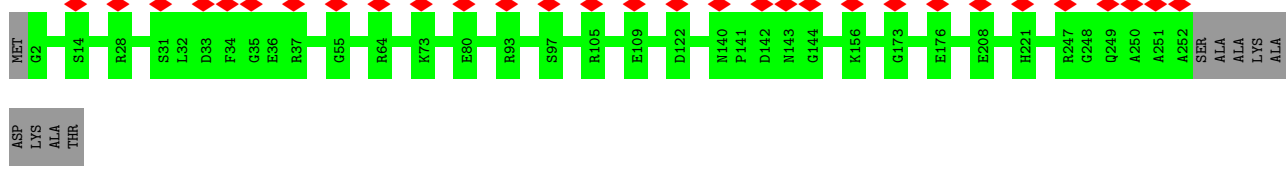

• Molecule 37: 60S ribosomal protein uL5

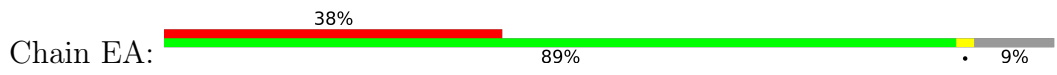

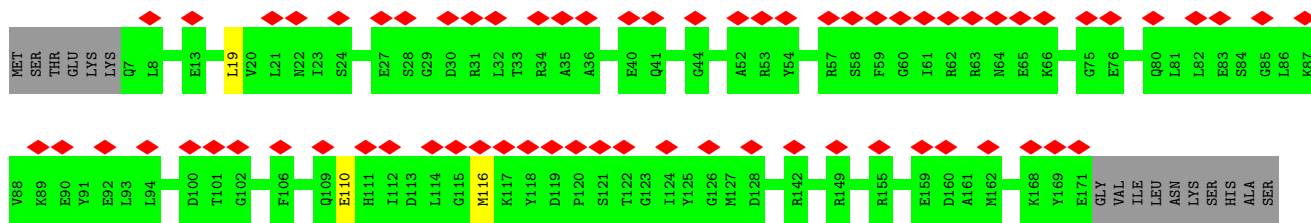

- Molecule 38: 60S ribosomal protein uL6

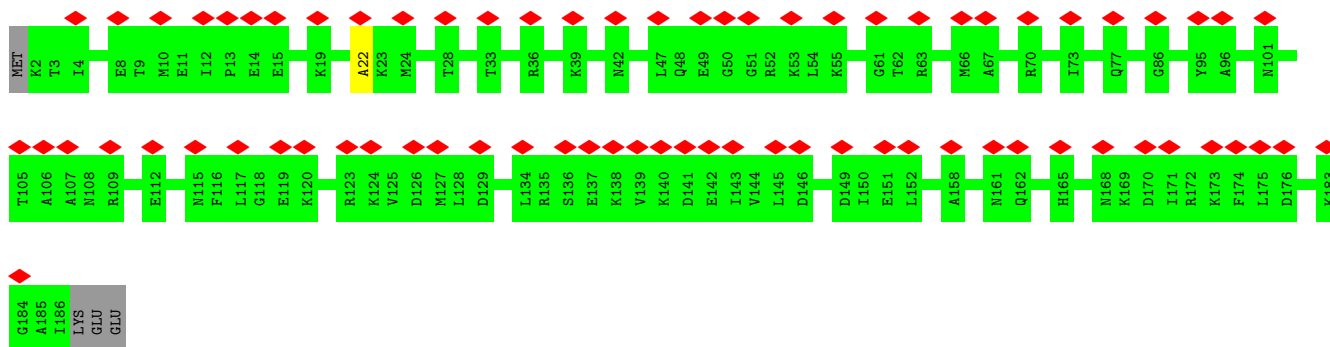
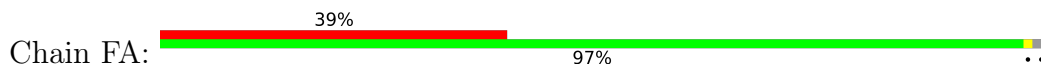

- Molecule 39: 60S ribosomal protein uL14

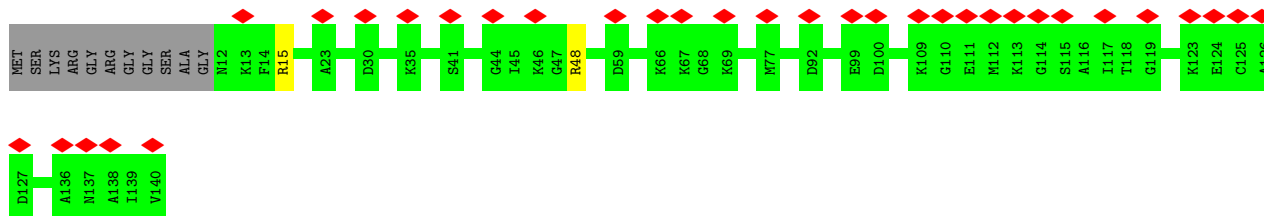

- Molecule 40: 60S ribosomal protein eL15

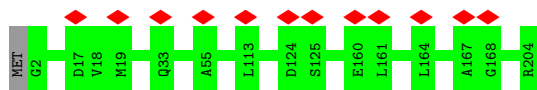

- Molecule 41: 60S ribosomal protein uL15

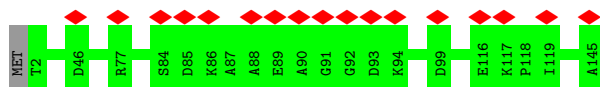

- Molecule 42: 60S ribosomal protein eL18

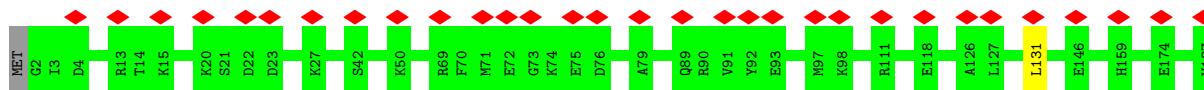

• Molecule 43: 60S ribosomal protein uL18

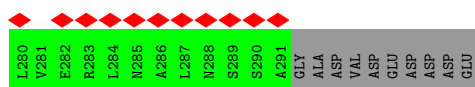
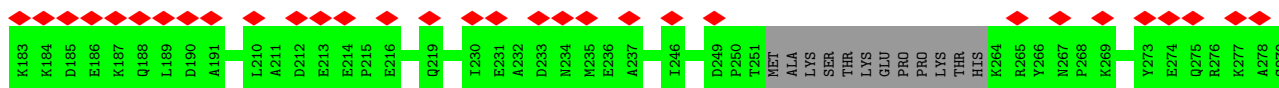
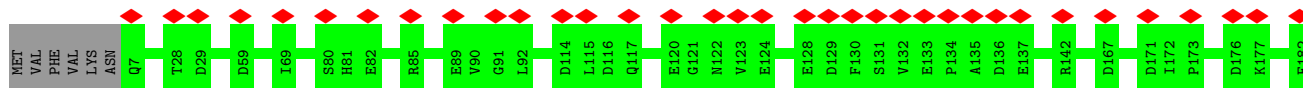
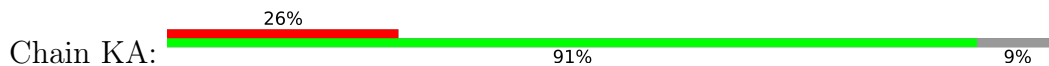

• Molecule 44: 60S ribosomal protein eL19

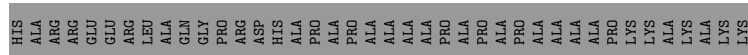
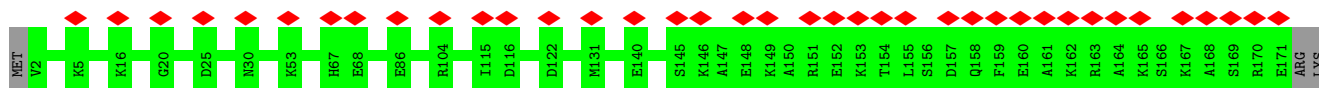
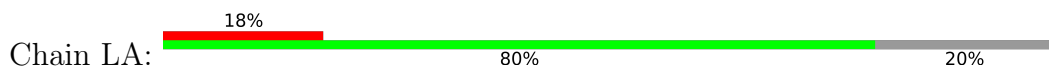

• Molecule 45: 60S ribosomal protein uL22

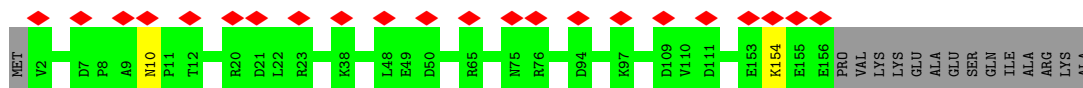

• Molecule 46: 60S ribosomal protein uL23

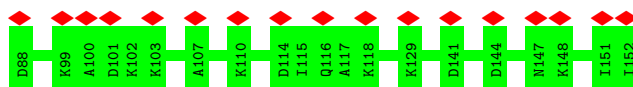
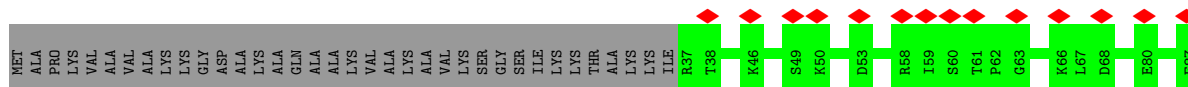
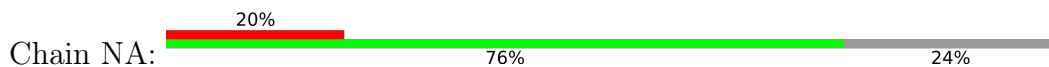

• Molecule 47: 60S ribosomal protein eL24



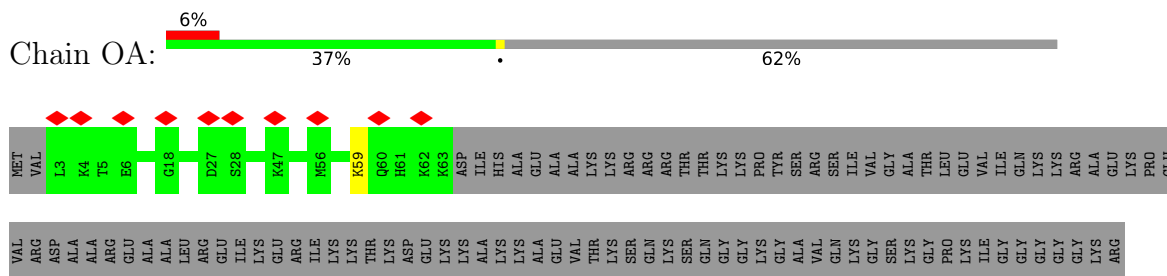

- Molecule 48: 60S ribosomal protein uL24

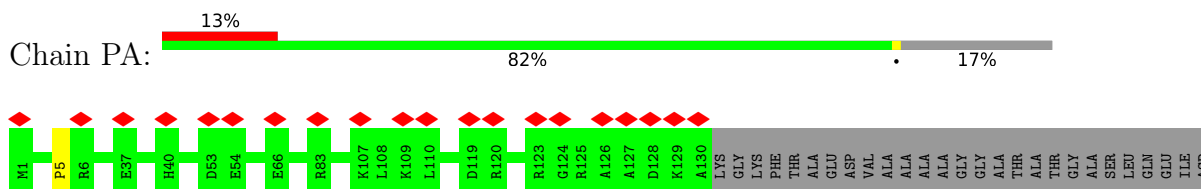

- Molecule 49: 60S ribosomal protein eL28

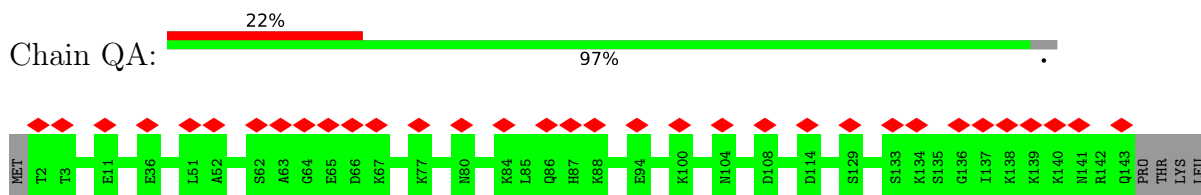

- Molecule 50: 60S ribosomal protein eL30

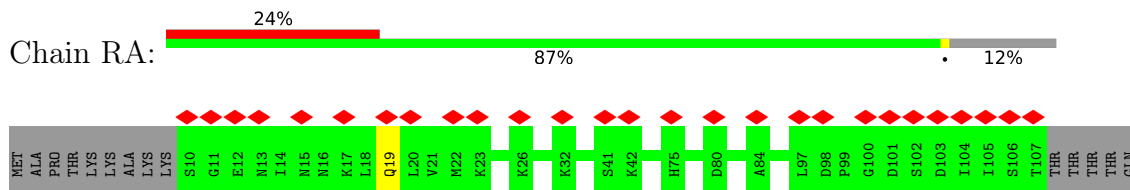

- Molecule 51: 60S ribosomal protein eL31

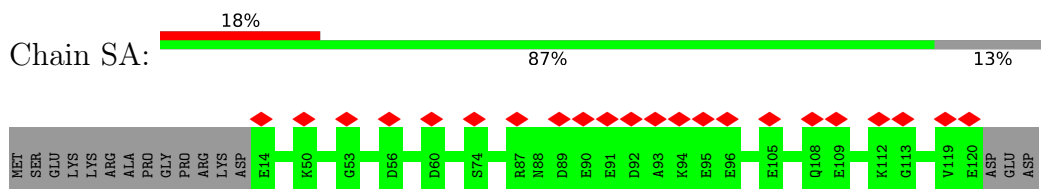

- Molecule 52: 60S ribosomal protein eL32

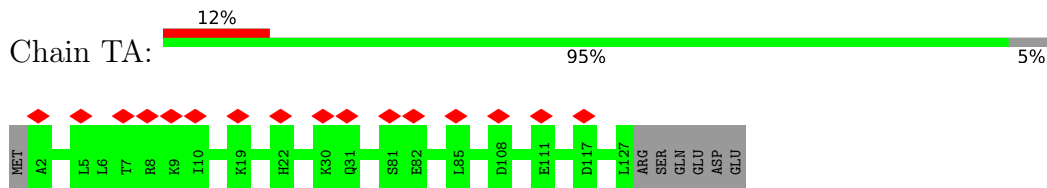

- Molecule 53: 60S ribosomal protein eL37

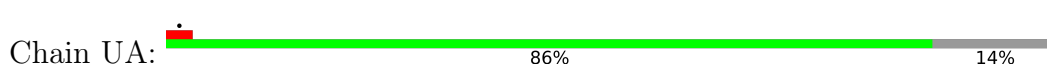

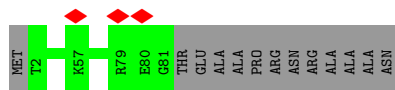

• Molecule 54: 60S ribosomal protein eL39

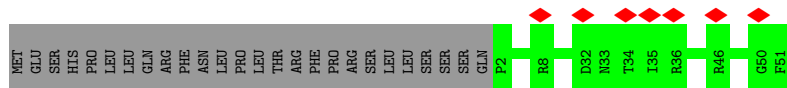

• Molecule 55: 60S ribosomal protein eL42

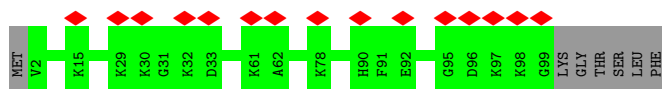

• Molecule 56: 60S ribosomal protein eL14

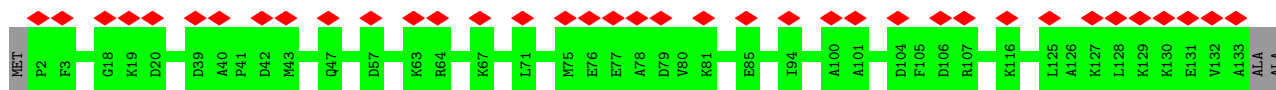

• Molecule 57: 60S ribosomal protein eL20

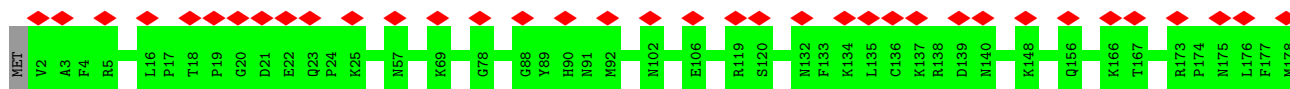

• Molecule 58: 60S ribosomal protein eL22

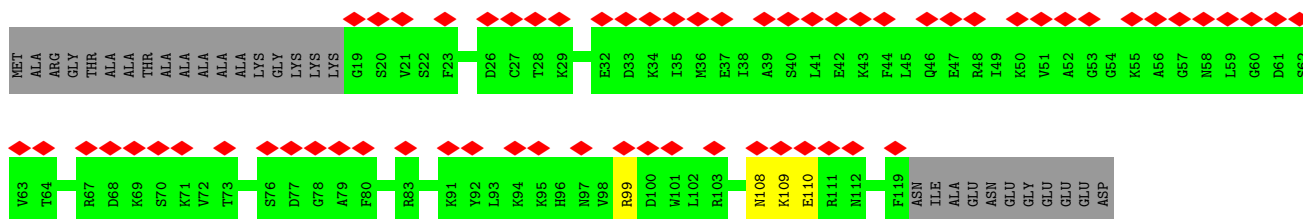
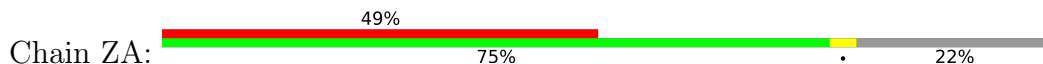

• Molecule 59: 60S ribosomal protein eL36



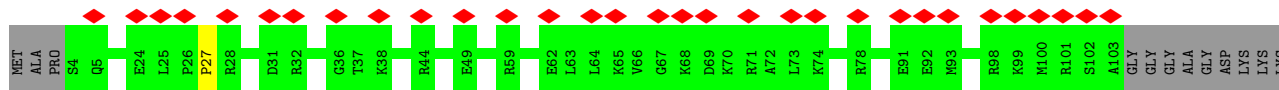

• Molecule 60: 60S ribosomal protein uL29

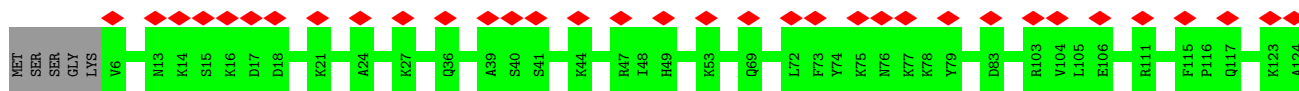

• Molecule 61: 60S ribosomal protein uL30

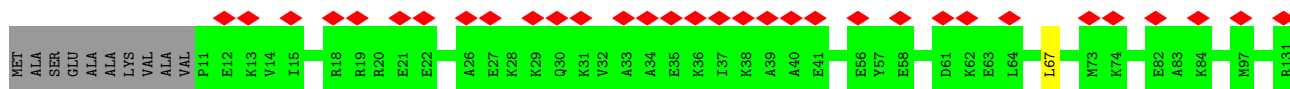

• Molecule 62: 60S ribosomal protein uL3

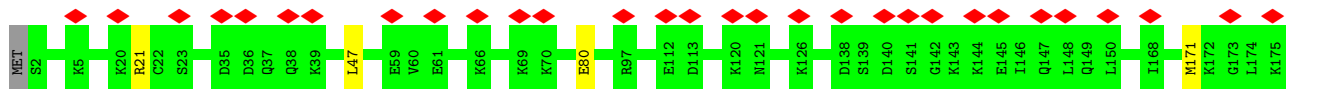

• Molecule 63: 60S ribosomal protein uL4

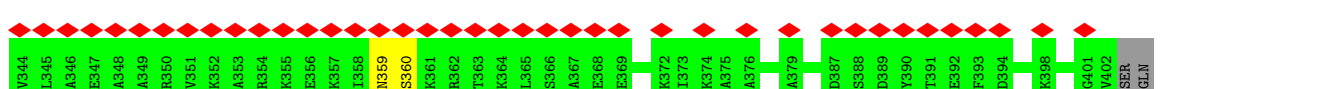
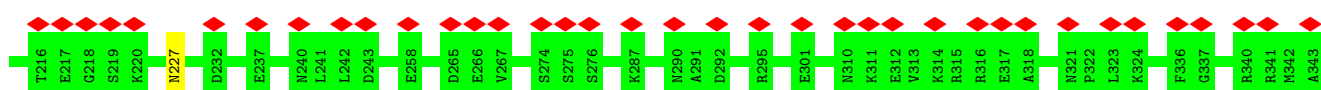
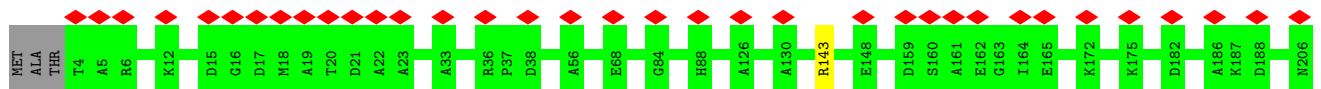

• Molecule 64: 60S ribosomal protein uL13

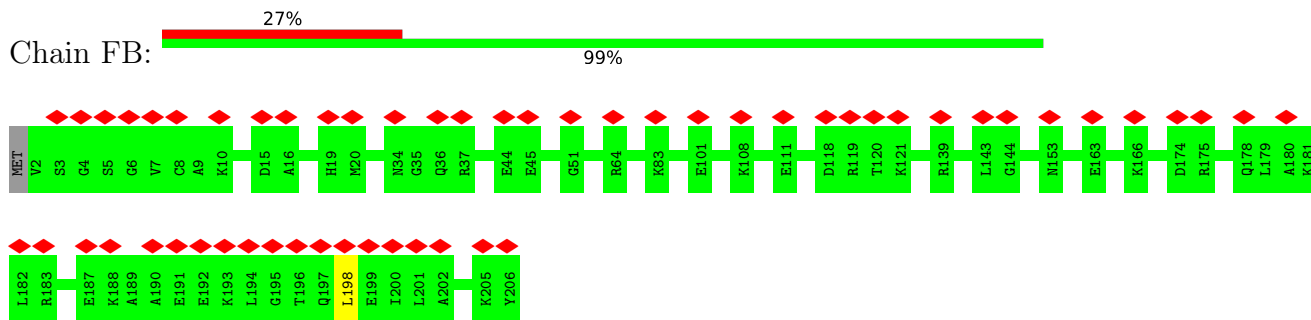

• Molecule 65: 60S ribosomal protein eL43

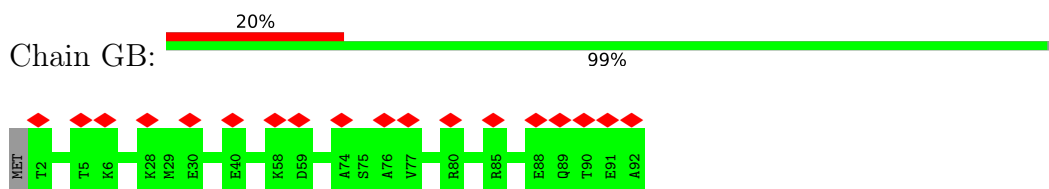

• Molecule 66: 60S ribosomal protein uL16

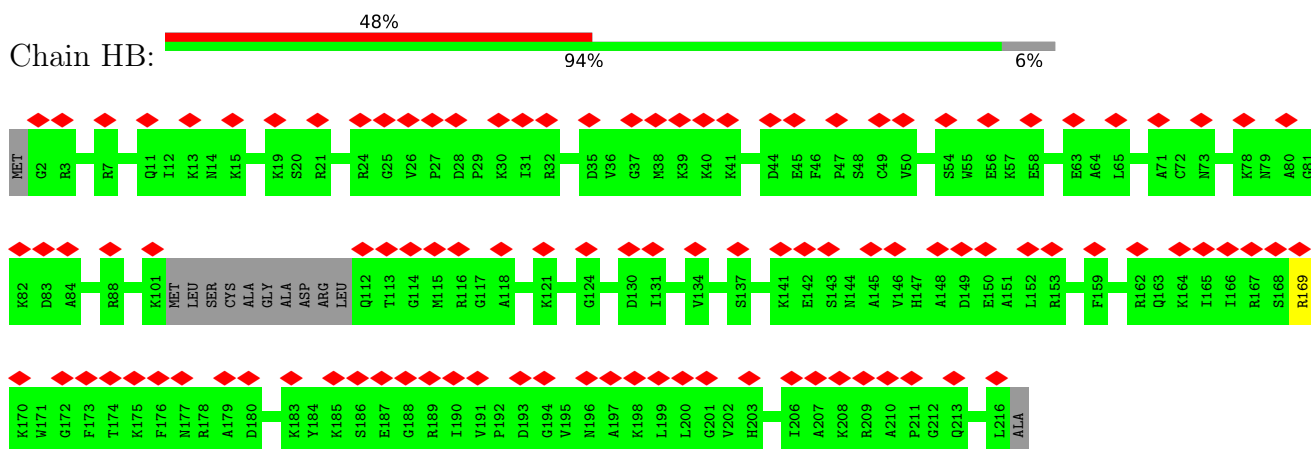

• Molecule 67: 60S ribosomal protein eL41

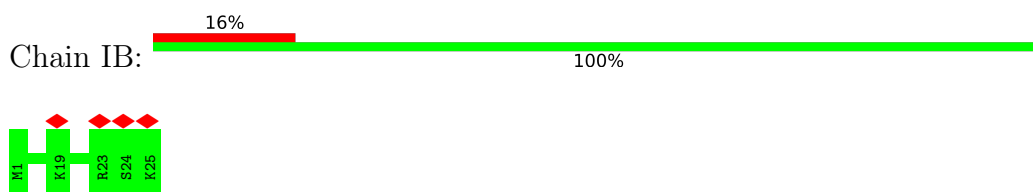

• Molecule 68: 60S ribosomal protein eL40

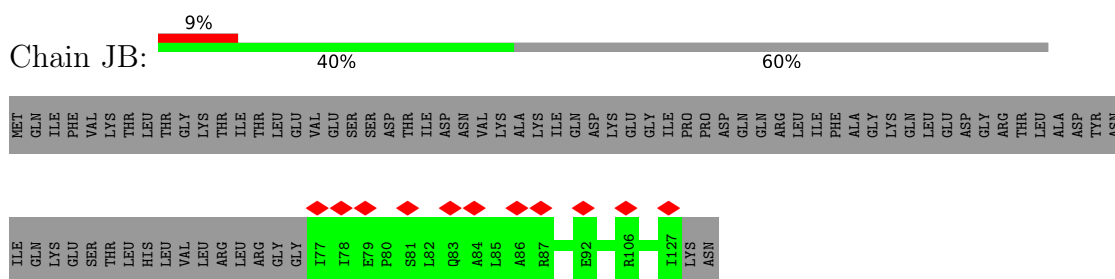

- Molecule 69: 60S ribosomal protein eL13

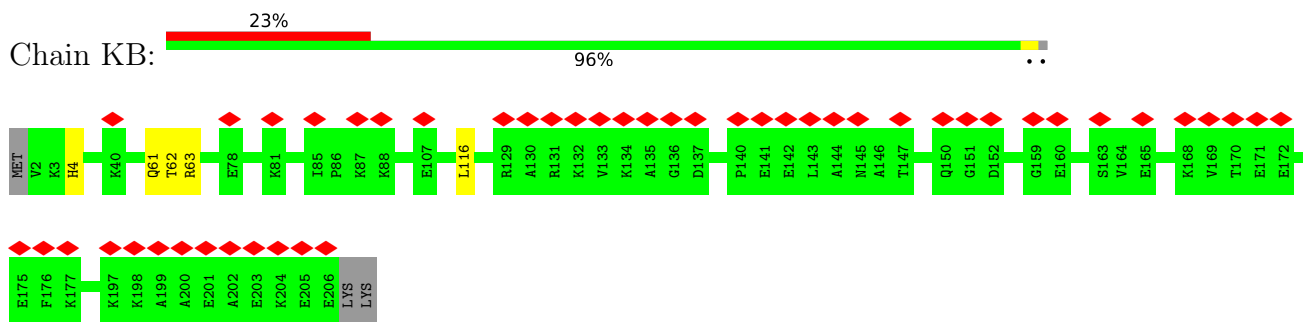

- Molecule 70: 60S ribosomal protein eL6

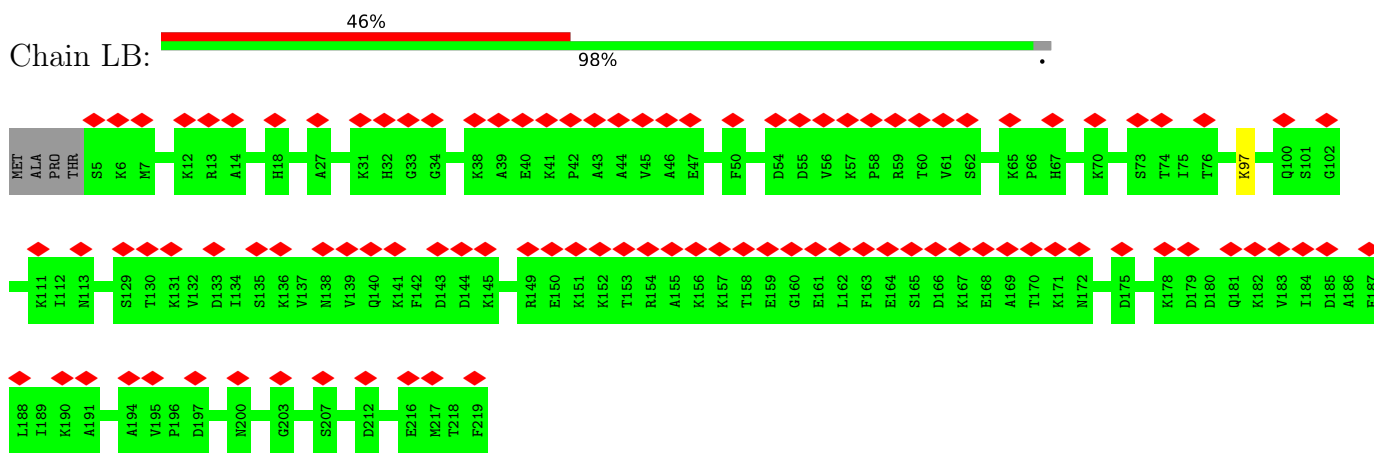

- Molecule 71: 60S ribosomal protein eL33

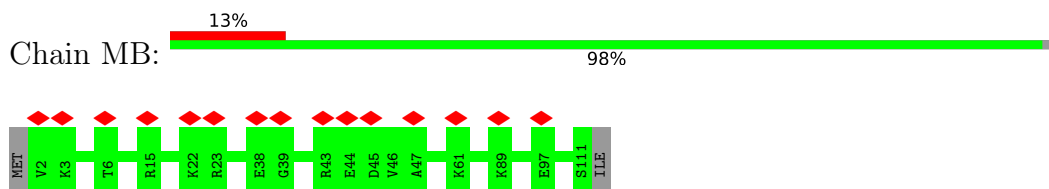

- Molecule 72: 60S ribosomal protein eL38

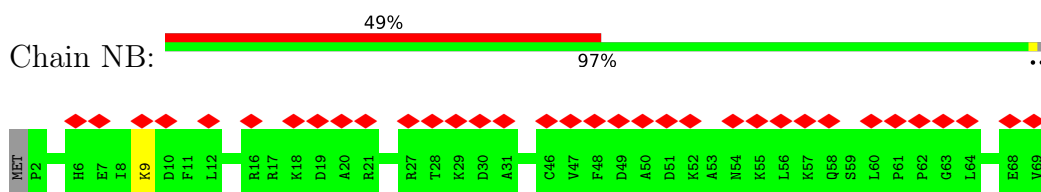

- Molecule 73: 60S ribosomal protein eL29

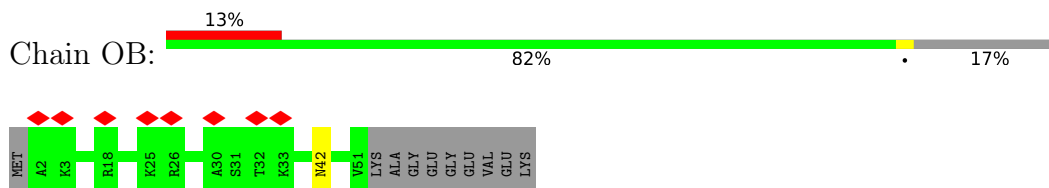

- Molecule 74: 60S ribosomal protein eL34

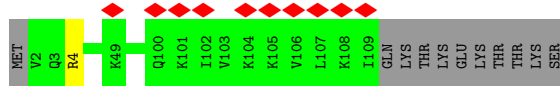
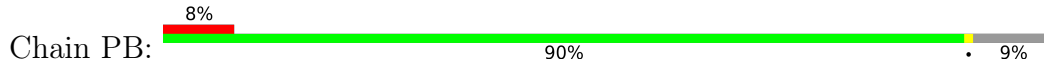

• Molecule 75: 60S ribosomal RNA

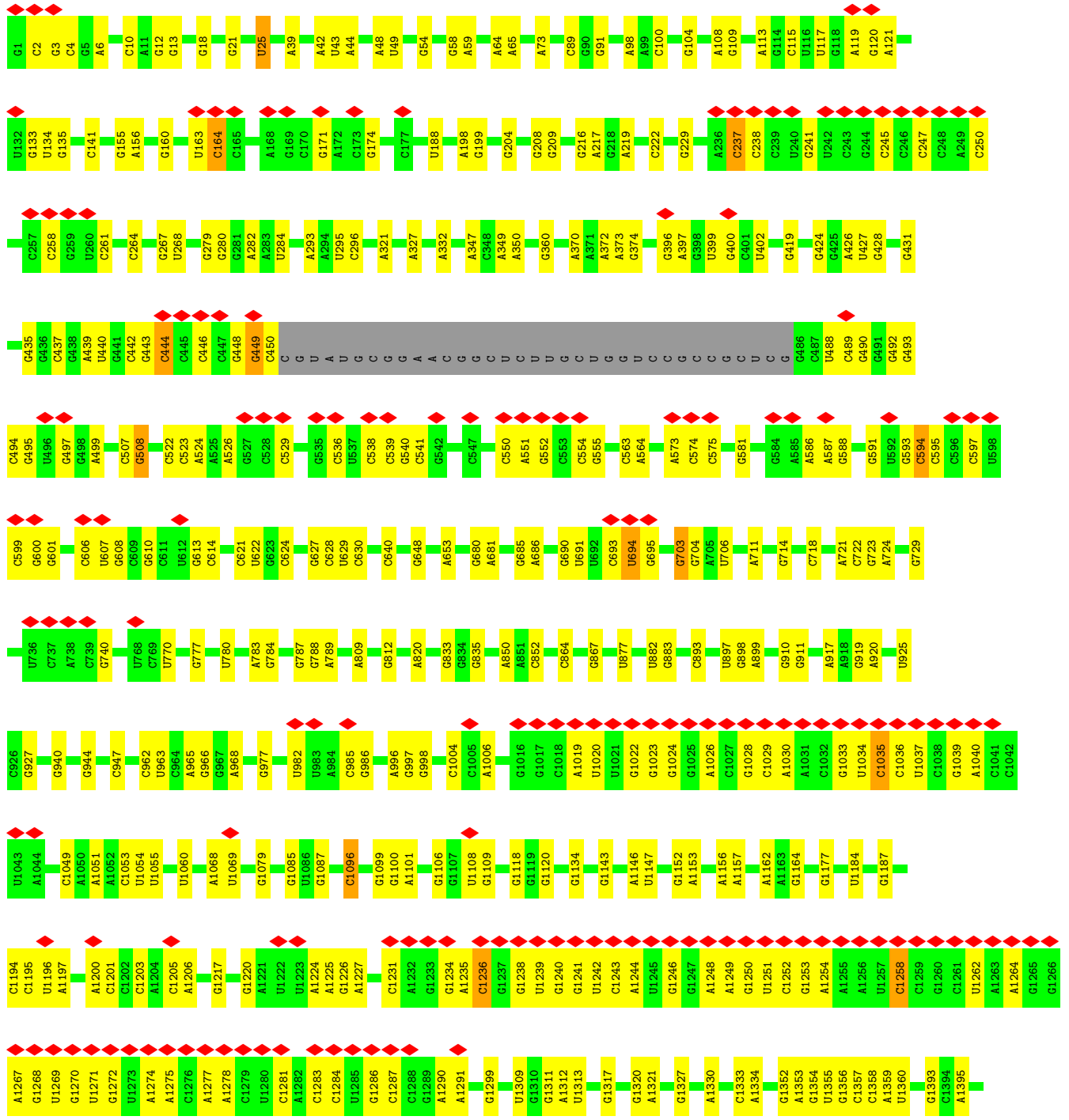
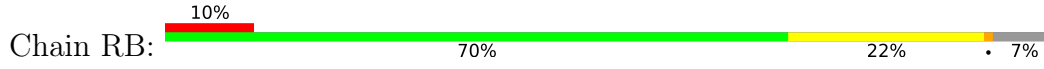

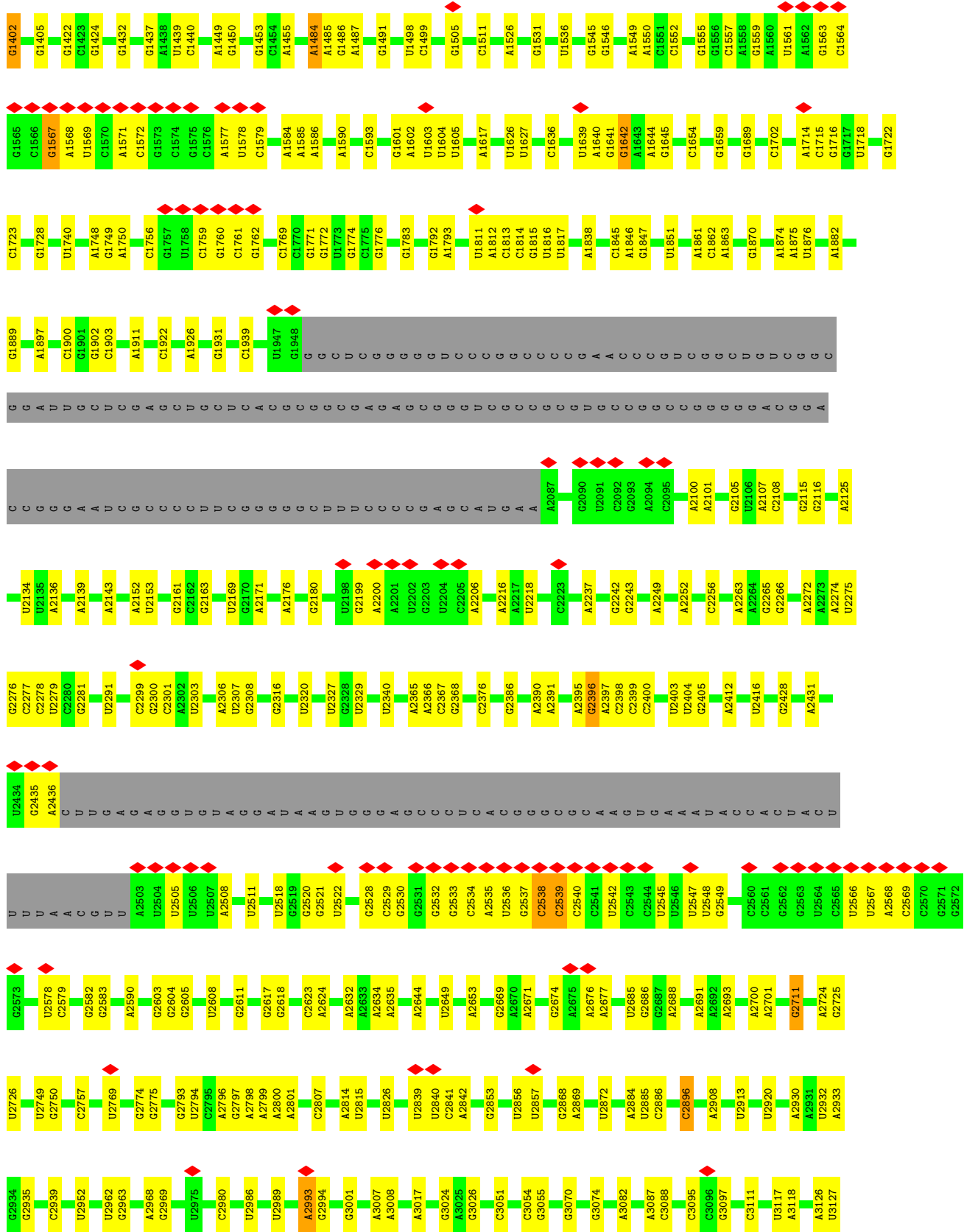

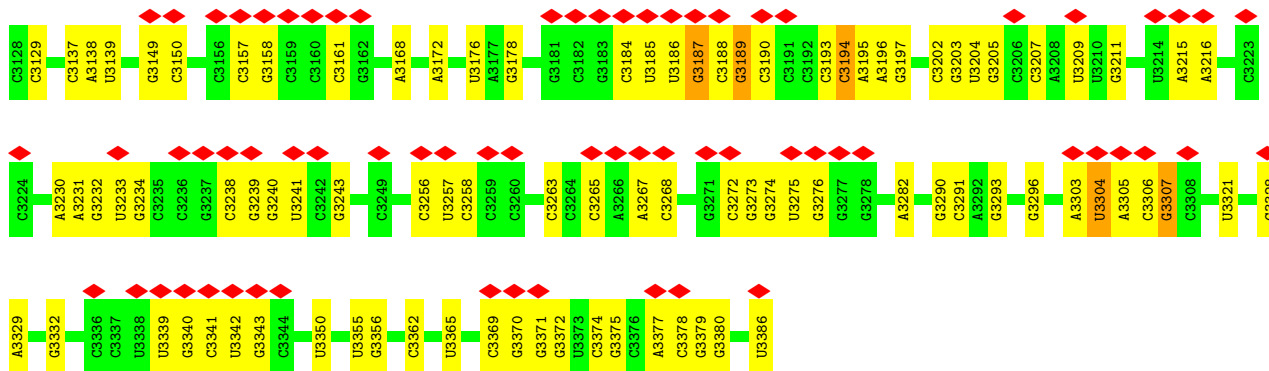

• Molecule 76: 5.8S ribosomal RNA

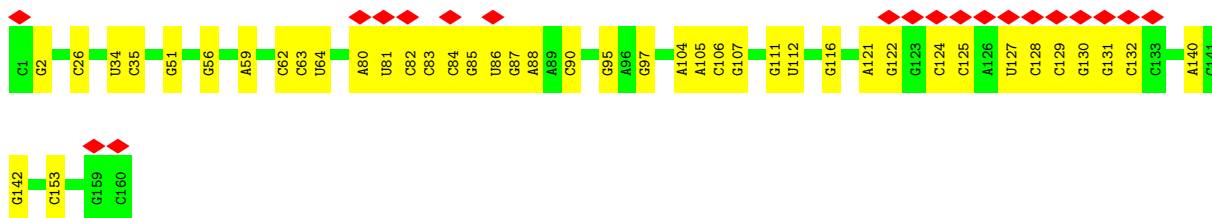
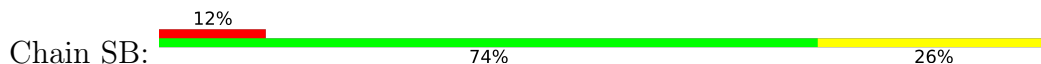

• Molecule 77: 5S ribosomal RNA

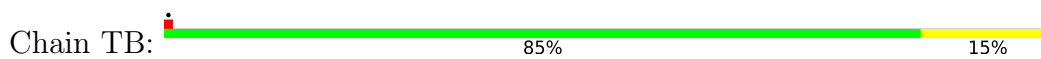

• Molecule 78: mRNA



• Molecule 79: eukaryotic release factor 1

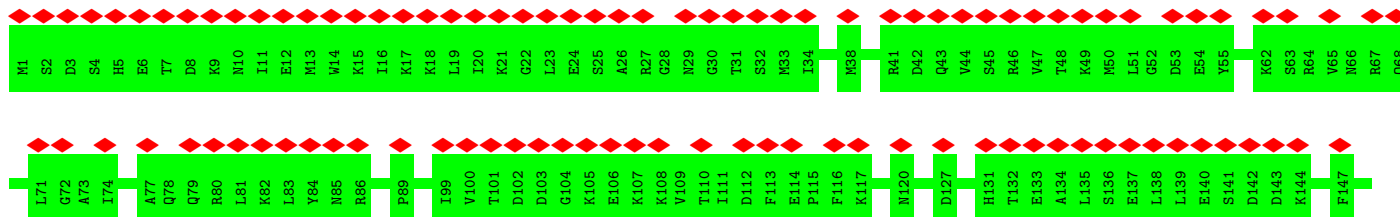
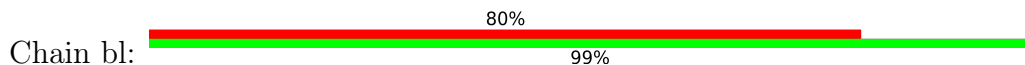





- Molecule 80: tRNA<sup>i</sup>

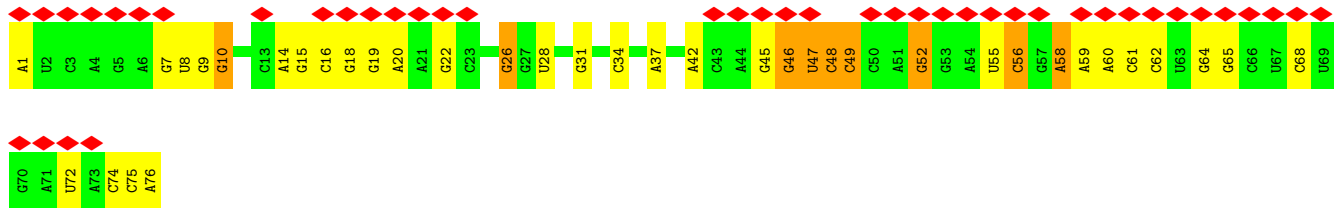

## 4 Experimental information

Property	Value	Source
EM reconstruction method	SINGLE PARTICLE	Depositor
Imposed symmetry	POINT, Not provided	
Number of particles used	69380	Depositor
Resolution determination method	FSC 0.143 CUT-OFF	Depositor
CTF correction method	PHASE FLIPPING AND AMPLITUDE CORRECTION	Depositor
Microscope	FEI TECNAI ARCTICA	Depositor
Voltage (kV)	200	Depositor
Electron dose ( $e^-/\text{\AA}^2$ )	40.0	Depositor
Minimum defocus (nm)	500	Depositor
Maximum defocus (nm)	3500	Depositor
Magnification	23500	Depositor
Image detector	GATAN K2 SUMMIT (4k x 4k)	Depositor
Maximum map value	0.209	Depositor
Minimum map value	-0.127	Depositor
Average map value	0.000	Depositor
Map value standard deviation	0.009	Depositor
Recommended contour level	0.04	Depositor
Map size ( $\text{\AA}$ )	588.0, 588.0, 588.0	wwPDB
Map dimensions	400, 400, 400	wwPDB
Map angles ( $^\circ$ )	90.0, 90.0, 90.0	wwPDB
Pixel spacing ( $\text{\AA}$ )	1.47, 1.47, 1.47	Depositor

## 5 Model quality

### 5.1 Standard geometry

Bond lengths and bond angles in the following residue types are not validated in this section: H2U, G7M, 2MG, 5MC, 1MG, MG, 1MA, 3HE, ZN, MIA, PSU

The Z score for a bond length (or angle) is the number of standard deviations the observed value is removed from the expected value. A bond length (or angle) with  $|Z| > 5$  is considered an outlier worth inspection. RMSZ is the root-mean-square of all Z scores of the bond lengths (or angles).

Mol	Chain	Bond lengths		Bond angles	
		RMSZ	# Z  >5	RMSZ	# Z  >5
1	aa	0.82	0/40441	0.99	61/63026 (0.1%)
2	ba	0.40	0/943	0.65	0/1253
3	ca	0.46	0/1464	0.61	0/1957
4	da	0.47	0/722	0.68	0/972
5	ga	0.47	0/1088	0.63	0/1448
6	ha	0.41	0/2530	0.68	2/3443 (0.1%)
7	ia	0.43	0/1697	0.68	0/2279
8	ja	0.44	0/2123	0.64	0/2853
9	ka	0.41	0/1538	0.69	3/2070 (0.1%)
10	la	0.47	0/1138	0.65	0/1517
11	ma	0.39	0/815	0.64	0/1098
12	na	0.41	0/953	0.70	1/1278 (0.1%)
13	oa	0.41	0/1132	0.71	1/1511 (0.1%)
14	pa	0.45	0/1219	0.63	0/1638
15	qa	0.40	0/985	0.67	0/1313
16	ra	0.47	0/1088	0.63	0/1463
17	sa	0.43	0/824	0.66	0/1102
18	ta	0.36	0/624	0.72	0/836
19	ua	0.40	0/514	0.66	0/685
20	va	0.56	0/1057	0.75	1/1421 (0.1%)
21	wa	0.52	0/318	0.66	0/418
22	xa	0.40	0/555	0.58	0/742
23	ya	0.38	0/326	0.56	0/430
24	za	0.42	0/1644	0.61	0/2226
25	bb	0.45	0/1749	0.67	0/2349
26	cb	0.47	0/605	0.71	0/814
27	db	0.48	0/784	0.60	0/1047
28	eb	0.46	0/1521	0.66	1/2035 (0.0%)
29	fb	0.53	0/1696	0.63	0/2292
30	gb	0.43	0/1210	0.66	0/1606
31	hb	0.43	0/1415	0.64	0/1907
32	ib	0.53	0/1192	0.61	0/1597

Mol	Chain	Bond lengths		Bond angles	
		RMSZ	# Z  >5	RMSZ	# Z  >5
33	AA	0.45	0/1881	0.61	0/2523
34	BA	0.54	0/1284	0.58	0/1728
35	CA	0.52	0/1111	0.64	0/1481
36	DA	0.59	0/1965	0.62	0/2644
37	EA	0.49	0/1353	0.69	1/1807 (0.1%)
38	FA	0.49	0/1478	0.64	0/1983
39	GA	0.56	0/992	0.60	0/1333
40	HA	0.65	0/1760	0.65	0/2354
41	IA	0.57	0/1152	0.60	0/1538
42	JA	0.54	0/1511	0.68	1/2021 (0.0%)
43	KA	0.49	0/2249	0.60	0/3020
44	LA	0.50	0/1433	0.62	0/1892
45	MA	0.53	0/1276	0.61	0/1713
46	NA	0.48	0/950	0.59	0/1275
47	OA	0.62	0/530	0.64	0/703
48	PA	0.53	0/1067	0.72	1/1425 (0.1%)
49	QA	0.49	0/1144	0.58	0/1536
50	RA	0.54	0/769	0.62	0/1035
51	SA	0.51	0/874	0.61	0/1171
52	TA	0.56	0/1061	0.62	0/1417
53	UA	0.61	0/669	0.68	0/886
54	VA	0.50	0/464	0.62	0/616
55	WA	0.52	0/807	0.59	0/1064
56	XA	0.46	0/1079	0.64	0/1440
57	YA	0.60	0/1534	0.64	0/2061
58	ZA	0.45	0/826	0.67	0/1106
59	AB	0.43	0/814	0.66	1/1077 (0.1%)
60	BB	0.42	0/990	0.67	0/1317
61	CB	0.56	0/1952	0.65	1/2614 (0.0%)
62	DB	0.57	1/3167 (0.0%)	0.65	2/4238 (0.0%)
63	EB	0.51	0/3133	0.63	0/4220
64	FB	0.51	0/1669	0.63	1/2236 (0.0%)
65	GB	0.61	0/716	0.64	0/948
66	HB	0.46	0/1670	0.58	0/2237
67	IB	0.49	0/238	0.75	0/302
68	JB	0.45	0/426	0.57	0/564
69	KB	0.51	0/1699	0.63	1/2269 (0.0%)
70	LB	0.45	0/1737	0.63	0/2334
71	MB	0.65	0/893	0.68	0/1198
72	NB	0.45	0/565	0.64	0/753
73	OB	0.49	0/424	0.60	0/561
74	PB	0.63	0/894	0.68	0/1197
75	RB	1.00	1/75401 (0.0%)	1.02	95/117598 (0.1%)

Mol	Chain	Bond lengths		Bond angles	
		RMSZ	# Z  >5	RMSZ	# Z  >5
76	SB	0.98	0/3809	1.02	11/5936 (0.2%)
77	TB	0.93	0/2864	0.93	2/4464 (0.0%)
78	al	0.96	0/165	1.19	0/256
79	bl	0.37	0/3503	0.62	0/4711
80	cl	0.74	1/1534 (0.1%)	1.11	11/2386 (0.5%)
All	All	0.78	3/215392 (0.0%)	0.89	198/315814 (0.1%)

Chiral center outliers are detected by calculating the chiral volume of a chiral center and verifying if the center is modelled as a planar moiety or with the opposite hand. A planarity outlier is detected by checking planarity of atoms in a peptide group, atoms in a mainchain group or atoms of a sidechain that are expected to be planar.

Mol	Chain	#Chirality outliers	#Planarity outliers
5	ga	0	1
6	ha	0	3
10	la	0	1
12	na	0	1
15	qa	0	1
18	ta	0	3
20	va	0	3
23	ya	0	1
25	bb	0	1
28	eb	0	1
31	hb	0	1
37	EA	0	2
38	FA	0	1
58	ZA	0	1
61	CB	0	1
62	DB	0	1
63	EB	0	1
69	KB	0	1
79	bl	0	2
All	All	0	27

All (3) bond length outliers are listed below:

Mol	Chain	Res	Type	Atoms	Z	Observed(Å)	Ideal(Å)
80	cl	1	A	OP3-P	-10.88	1.48	1.61
75	RB	2143	A	N9-C4	-6.31	1.34	1.37
62	DB	171	MET	CA-CB	-5.01	1.43	1.53

All (198) bond angle outliers are listed below:

Mol	Chain	Res	Type	Atoms	Z	Observed(°)	Ideal(°)
1	aa	742	C	C2-N1-C1'	9.72	129.50	118.80
75	RB	1236	C	C6-N1-C2	-9.68	116.43	120.30
75	RB	1236	C	N1-C2-O2	9.55	124.63	118.90
75	RB	1236	C	N3-C2-O2	-9.37	115.34	121.90
1	aa	742	C	N1-C2-O2	9.00	124.30	118.90
1	aa	1441	C	C2-N1-C1'	8.78	128.46	118.80
59	AB	27	PRO	C-N-CA	7.97	141.61	121.70
75	RB	1258	C	N3-C2-O2	-7.75	116.47	121.90
76	SB	142	G	N3-C4-N9	-7.74	121.36	126.00
76	SB	124	C	N1-C2-O2	7.69	123.51	118.90
1	aa	1441	C	N1-C2-O2	7.62	123.47	118.90
75	RB	1236	C	C2-N1-C1'	7.54	127.09	118.80
76	SB	125	C	N3-C2-O2	-7.49	116.66	121.90
75	RB	3194	C	C2-N1-C1'	7.39	126.94	118.80
75	RB	2539	C	N3-C2-O2	-7.39	116.73	121.90
75	RB	2539	C	N1-C2-O2	7.30	123.28	118.90
75	RB	2608	U	N3-C2-O2	-7.22	117.15	122.20
1	aa	457	C	C2-N1-C1'	7.21	126.73	118.80
80	cl	56	C	C2-N1-C1'	7.20	126.72	118.80
1	aa	742	C	C6-N1-C1'	-7.15	112.22	120.80
75	RB	594	C	C2-N1-C1'	7.13	126.64	118.80
75	RB	925	U	C2-N1-C1'	7.02	126.12	117.70
48	PA	5	PRO	CA-N-CD	-7.01	101.69	111.50
80	cl	56	C	N1-C2-O2	6.97	123.08	118.90
75	RB	449	G	N3-C4-N9	-6.87	121.88	126.00
1	aa	1077	C	C2-N1-C1'	6.85	126.34	118.80
75	RB	1659	G	N3-C4-N9	-6.82	121.91	126.00
1	aa	457	C	N1-C2-O2	6.74	122.95	118.90
75	RB	3341	C	C2-N1-C1'	6.74	126.22	118.80
75	RB	449	G	C4-N9-C1'	-6.71	117.78	126.50
75	RB	3194	C	N1-C2-O2	6.64	122.88	118.90
75	RB	164	C	C2-N1-C1'	6.63	126.09	118.80
75	RB	100	C	C2-N1-C1'	6.61	126.07	118.80
75	RB	1096	C	C2-N1-C1'	6.57	126.03	118.80
75	RB	1287	C	N3-C2-O2	-6.57	117.30	121.90
1	aa	1189	U	C2-N1-C1'	6.55	125.56	117.70
1	aa	1441	C	C6-N1-C1'	-6.54	112.95	120.80
75	RB	449	G	C8-N9-C1'	6.54	135.50	127.00
75	RB	1484	A	N1-C2-N3	6.53	132.57	129.30
75	RB	1236	C	C5-C6-N1	6.44	124.22	121.00
6	ha	32	PRO	CA-N-CD	-6.44	102.49	111.50
80	cl	75	C	C6-N1-C2	-6.43	117.73	120.30
75	RB	3341	C	N1-C2-O2	6.42	122.75	118.90

Continued on next page...

*Continued from previous page...*

Mol	Chain	Res	Type	Atoms	Z	Observed(°)	Ideal(°)
1	aa	1395	C	C2-N1-C1'	6.35	125.79	118.80
1	aa	808	G	N3-C4-C5	-6.35	125.43	128.60
1	aa	742	C	N3-C2-O2	-6.34	117.46	121.90
75	RB	507	C	C2-N1-C1'	6.34	125.77	118.80
80	cl	62	C	N3-C2-O2	-6.31	117.48	121.90
80	cl	52	G	N3-C4-N9	6.29	129.78	126.00
75	RB	2399	C	C6-N1-C2	-6.28	117.79	120.30
75	RB	489	C	N3-C2-O2	-6.25	117.53	121.90
75	RB	295	U	C2-N1-C1'	6.24	125.19	117.70
1	aa	1568	U	C2-N1-C1'	6.22	125.16	117.70
76	SB	142	G	N3-C4-C5	6.12	131.66	128.60
77	TB	79	A	N1-C2-N3	6.12	132.36	129.30
1	aa	819	U	C2-N1-C1'	6.05	124.96	117.70
75	RB	25	U	N3-C2-O2	-6.04	117.97	122.20
75	RB	694	U	C2-N1-C1'	6.00	124.90	117.70
1	aa	67	G	C4-N9-C1'	6.00	134.30	126.50
1	aa	1502	C	C2-N1-C1'	5.98	125.38	118.80
1	aa	105	A	P-O3'-C3'	5.97	126.86	119.70
76	SB	124	C	N3-C2-O2	-5.96	117.72	121.90
1	aa	1368	C	C2-N1-C1'	5.95	125.35	118.80
1	aa	1359	C	C2-N1-C1'	5.95	125.34	118.80
75	RB	1783	G	N3-C4-N9	-5.93	122.44	126.00
75	RB	1641	G	N3-C4-N9	-5.92	122.45	126.00
20	va	33	MET	CB-CG-SD	-5.90	94.70	112.40
75	RB	1147	U	C5-C4-O4	-5.89	122.37	125.90
75	RB	264	C	C2-N1-C1'	5.85	125.24	118.80
75	RB	3187	G	N3-C4-N9	-5.85	122.49	126.00
76	SB	125	C	N1-C2-O2	5.84	122.41	118.90
80	cl	52	G	C4-N9-C1'	5.84	134.10	126.50
9	ka	149	LEU	CA-CB-CG	5.83	128.71	115.30
75	RB	1499	C	C2-N1-C1'	5.83	125.22	118.80
75	RB	3187	G	N3-C4-C5	5.83	131.51	128.60
75	RB	444	C	N1-C2-O2	5.82	122.39	118.90
1	aa	506	G	N3-C4-N9	5.81	129.49	126.00
1	aa	1311	U	C2-N1-C1'	5.81	124.67	117.70
75	RB	893	C	C6-N1-C2	-5.80	117.98	120.30
75	RB	594	C	C6-N1-C1'	-5.78	113.86	120.80
9	ka	149	LEU	CB-CG-CD2	-5.78	101.18	111.00
1	aa	1725	C	OP1-P-O3'	5.75	117.85	105.20
1	aa	1441	C	N3-C2-O2	-5.70	117.91	121.90
75	RB	258	C	N3-C2-O2	-5.69	117.92	121.90
76	SB	124	C	C2-N1-C1'	5.68	125.05	118.80

*Continued on next page...*

*Continued from previous page...*

Mol	Chain	Res	Type	Atoms	Z	Observed(°)	Ideal(°)
75	RB	3304	U	C2-N1-C1'	5.67	124.51	117.70
6	ha	203	LEU	CA-CB-CG	5.67	128.34	115.30
75	RB	2400	C	C6-N1-C2	-5.67	118.03	120.30
75	RB	449	G	O4'-C1'-N9	5.66	112.73	108.20
42	JA	131	LEU	CA-CB-CG	5.66	128.32	115.30
75	RB	3189	G	C4-N9-C1'	5.65	133.84	126.50
75	RB	1659	G	N3-C4-C5	5.65	131.42	128.60
75	RB	18	G	N3-C4-N9	-5.64	122.62	126.00
64	FB	198	LEU	CA-CB-CG	5.62	128.22	115.30
1	aa	742	C	C5-C6-N1	5.60	123.80	121.00
1	aa	17	C	C6-N1-C2	-5.58	118.07	120.30
80	cl	52	G	N3-C4-C5	-5.58	125.81	128.60
75	RB	3184	C	C5-C6-N1	5.57	123.79	121.00
1	aa	1567	G	O4'-C1'-N9	5.57	112.65	108.20
75	RB	694	U	N1-C2-O2	5.55	126.69	122.80
1	aa	1502	C	N1-C2-O2	5.55	122.23	118.90
1	aa	277	G	N7-C8-N9	5.55	115.88	113.10
1	aa	1277	G	C4-N9-C1'	-5.55	119.29	126.50
80	cl	56	C	C6-N1-C1'	-5.55	114.14	120.80
1	aa	808	G	N3-C4-N9	5.54	129.32	126.00
1	aa	819	U	N1-C2-O2	5.54	126.67	122.80
75	RB	444	C	C2-N1-C1'	5.51	124.86	118.80
75	RB	1567	G	N3-C4-N9	5.49	129.30	126.00
75	RB	1147	U	N3-C4-O4	5.48	123.24	119.40
62	DB	47	LEU	CA-CB-CG	5.48	127.90	115.30
1	aa	540	C	C2-N1-C1'	5.48	124.83	118.80
1	aa	1502	C	C5-C6-N1	5.48	123.74	121.00
75	RB	1601	G	C2-N3-C4	5.47	114.64	111.90
1	aa	17	C	N3-C2-O2	-5.47	118.07	121.90
76	SB	26	C	C6-N1-C2	-5.46	118.12	120.30
75	RB	264	C	C6-N1-C1'	-5.45	114.26	120.80
75	RB	3341	C	C6-N1-C1'	-5.44	114.27	120.80
1	aa	1294	U	N3-C2-O2	-5.42	118.41	122.20
1	aa	801	U	C2-N1-C1'	5.41	124.20	117.70
75	RB	237	C	C2-N1-C1'	5.41	124.75	118.80
75	RB	606	C	C6-N1-C2	-5.41	118.14	120.30
1	aa	783	C	C2-N1-C1'	5.39	124.73	118.80
1	aa	942	C	C6-N1-C2	-5.38	118.15	120.30
75	RB	3189	G	C8-N9-C1'	-5.35	120.05	127.00
1	aa	1368	C	N1-C2-O2	5.34	122.10	118.90
1	aa	1005	C	C2-N1-C1'	5.33	124.67	118.80
75	RB	2396	G	N3-C4-C5	-5.33	125.93	128.60

*Continued on next page...*



*Continued from previous page...*

Mol	Chain	Res	Type	Atoms	Z	Observed(°)	Ideal(°)
80	cl	56	C	N3-C2-O2	-5.31	118.18	121.90
75	RB	3194	C	N3-C2-O2	-5.31	118.19	121.90
75	RB	2256	C	C5-C6-N1	5.30	123.65	121.00
75	RB	2711	G	C4-N9-C1'	5.30	133.39	126.50
75	RB	1641	G	N3-C4-C5	5.29	131.25	128.60
37	EA	19	LEU	CA-CB-CG	5.27	127.41	115.30
75	RB	280	G	N3-C4-N9	-5.27	122.84	126.00
1	aa	117	U	N3-C2-O2	-5.26	118.52	122.20
1	aa	1057	U	P-O3'-C3'	5.25	126.00	119.70
75	RB	1772	G	C2-N3-C4	-5.25	109.28	111.90
75	RB	2993	A	OP2-P-O3'	5.25	116.75	105.20
1	aa	1077	C	C6-N1-C1'	-5.25	114.50	120.80
75	RB	2399	C	C5-C6-N1	5.25	123.62	121.00
75	RB	261	C	C2-N1-C1'	5.24	124.56	118.80
75	RB	449	G	N3-C4-C5	5.23	131.22	128.60
75	RB	3189	G	N3-C4-N9	5.22	129.13	126.00
75	RB	3194	C	C6-N1-C1'	-5.22	114.54	120.80
75	RB	2757	C	C2-N1-C1'	5.21	124.53	118.80
75	RB	100	C	C6-N1-C1'	-5.20	114.56	120.80
75	RB	449	G	P-O3'-C3'	5.19	125.93	119.70
75	RB	1152	G	N3-C4-N9	5.19	129.11	126.00
1	aa	547	C	C6-N1-C2	-5.19	118.22	120.30
75	RB	3307	G	N3-C4-C5	-5.18	126.01	128.60
75	RB	1118	G	C4-N9-C1'	5.18	133.23	126.50
1	aa	585	U	N3-C2-O2	-5.17	118.58	122.20
1	aa	787	C	N1-C2-O2	5.16	122.00	118.90
1	aa	1261	U	C2-N1-C1'	5.16	123.89	117.70
1	aa	1395	C	C6-N1-C2	-5.16	118.24	120.30
69	KB	116	LEU	CB-CG-CD2	-5.15	102.24	111.00
13	oa	16	LEU	CB-CG-CD2	-5.14	102.26	111.00
1	aa	587	C	C2-N1-C1'	5.13	124.44	118.80
1	aa	67	G	C8-N9-C1'	-5.13	120.33	127.00
75	RB	1642	G	C4-N9-C1'	5.13	133.17	126.50
76	SB	64	U	N3-C2-O2	-5.12	118.61	122.20
1	aa	457	C	N3-C2-O2	-5.12	118.31	121.90
1	aa	1068	G	C6-C5-N7	-5.12	127.33	130.40
75	RB	508	G	C4-N9-C1'	5.11	133.15	126.50
1	aa	1388	A	N9-C4-C5	5.11	107.84	105.80
61	CB	67	LEU	CA-CB-CG	5.10	127.04	115.30
76	SB	131	G	N1-C2-N2	-5.10	111.61	116.20
1	aa	1066	U	N1-C2-O2	5.10	126.37	122.80
9	ka	14	LEU	CA-CB-CG	5.09	127.02	115.30

*Continued on next page...*

*Continued from previous page...*

Mol	Chain	Res	Type	Atoms	Z	Observed(°)	Ideal(°)
75	RB	2398	C	C2-N1-C1'	5.09	124.40	118.80
75	RB	3184	C	C6-N1-C2	-5.09	118.26	120.30
75	RB	1450	G	C8-N9-C4	5.09	108.44	106.40
75	RB	507	C	N1-C2-O2	5.08	121.95	118.90
75	RB	1897	A	C8-N9-C4	-5.08	103.77	105.80
80	cl	52	G	C8-N9-C1'	-5.08	120.39	127.00
75	RB	1642	G	C8-N9-C1'	-5.08	120.39	127.00
77	TB	79	A	C2-N3-C4	-5.08	108.06	110.60
75	RB	2538	C	O4'-C1'-N1	5.07	112.26	108.20
1	aa	201	G	C4-N9-C1'	5.07	133.09	126.50
75	RB	1035	C	N1-C2-O2	5.07	121.94	118.90
80	cl	62	C	N1-C2-N3	5.07	122.75	119.20
62	DB	21	ARG	CA-CB-CG	5.07	124.55	113.40
76	SB	142	G	C8-N9-C1'	5.05	133.57	127.00
1	aa	1368	C	C6-N1-C1'	-5.05	114.74	120.80
1	aa	742	C	C6-N1-C2	-5.05	118.28	120.30
1	aa	906	G	C4-N9-C1'	5.04	133.06	126.50
75	RB	2605	G	N3-C4-N9	-5.04	122.98	126.00
75	RB	2896	C	C2-N1-C1'	5.04	124.35	118.80
75	RB	1164	G	C4-N9-C1'	5.04	133.05	126.50
12	na	88	LEU	CA-CB-CG	5.03	126.88	115.30
1	aa	1068	G	C4-N9-C1'	5.03	133.04	126.50
75	RB	2256	C	C6-N1-C2	-5.03	118.29	120.30
75	RB	507	C	C6-N1-C1'	-5.03	114.77	120.80
75	RB	3307	G	N3-C4-N9	5.03	129.02	126.00
28	eb	87	LEU	CA-CB-CG	5.01	126.82	115.30
1	aa	457	C	C6-N1-C1'	-5.01	114.79	120.80
75	RB	1402	G	C4-N9-C1'	5.01	133.01	126.50
75	RB	703	G	P-O3'-C3'	5.00	125.71	119.70

There are no chirality outliers.

All (27) planarity outliers are listed below:

Mol	Chain	Res	Type	Group
61	CB	232	ARG	Peptide
62	DB	80	GLU	Peptide
37	EA	110	GLU	Peptide
37	EA	116	MET	Peptide
63	EB	360	SER	Peptide
38	FA	22	ALA	Peptide
69	KB	61	GLN	Peptide
58	ZA	108	ASN	Peptide

*Continued on next page...*

*Continued from previous page...*

Mol	Chain	Res	Type	Group
25	bb	54	THR	Peptide
79	bl	232	ASP	Peptide
79	bl	360	ASP	Peptide
28	eb	4	VAL	Peptide
5	ga	85	PRO	Peptide
6	ha	205	GLY	Peptide
6	ha	227	LYS	Peptide
6	ha	48	LEU	Peptide
31	hb	107	LYS	Peptide
10	la	46	ARG	Peptide
12	na	137	THR	Peptide
15	qa	67	ARG	Peptide
18	ta	33	GLN	Peptide
18	ta	70	LEU	Peptide
18	ta	76	LEU	Peptide
20	va	5	ILE	Peptide
20	va	75	THR	Peptide
20	va	84	GLU	Peptide
23	ya	44	PHE	Peptide

## 5.2 Too-close contacts [i](#)

Due to software issues we are unable to calculate clashes - this section is therefore empty.

## 5.3 Torsion angles [i](#)

### 5.3.1 Protein backbone [i](#)

In the following table, the Percentiles column shows the percent Ramachandran outliers of the chain as a percentile score with respect to all PDB entries followed by that with respect to all EM entries.

The Analysed column shows the number of residues for which the backbone conformation was analysed, and the total number of residues.

Mol	Chain	Analysed	Favoured	Allowed	Outliers	Percentiles	
2	ba	111/137 (81%)	100 (90%)	11 (10%)	0	100	100
3	ca	174/225 (77%)	158 (91%)	16 (9%)	0	100	100
4	da	79/188 (42%)	69 (87%)	10 (13%)	0	100	100
5	ga	136/142 (96%)	127 (93%)	9 (7%)	0	100	100

*Continued on next page...*

*Continued from previous page...*

Mol	Chain	Analysed	Favoured	Allowed	Outliers	Percentiles	
6	ha	320/332 (96%)	270 (84%)	50 (16%)	0	100	100
7	ia	211/227 (93%)	196 (93%)	15 (7%)	0	100	100
8	ja	259/265 (98%)	239 (92%)	20 (8%)	0	100	100
9	ka	191/200 (96%)	177 (93%)	14 (7%)	0	100	100
10	la	138/149 (93%)	122 (88%)	16 (12%)	0	100	100
11	ma	101/127 (80%)	89 (88%)	12 (12%)	0	100	100
12	na	123/151 (82%)	114 (93%)	9 (7%)	0	100	100
13	oa	134/152 (88%)	118 (88%)	16 (12%)	0	100	100
14	pa	148/151 (98%)	137 (93%)	11 (7%)	0	100	100
15	qa	117/143 (82%)	110 (94%)	7 (6%)	0	100	100
16	ra	133/155 (86%)	123 (92%)	10 (8%)	0	100	100
17	sa	98/154 (64%)	88 (90%)	10 (10%)	0	100	100
18	ta	75/108 (69%)	52 (69%)	23 (31%)	0	100	100
19	ua	62/86 (72%)	59 (95%)	3 (5%)	0	100	100
20	va	126/129 (98%)	107 (85%)	18 (14%)	1 (1%)	19	51
21	wa	37/56 (66%)	35 (95%)	2 (5%)	0	100	100
22	xa	68/86 (79%)	65 (96%)	3 (4%)	0	100	100
23	ya	37/62 (60%)	31 (84%)	6 (16%)	0	100	100
24	za	200/308 (65%)	181 (90%)	19 (10%)	0	100	100
25	bb	209/263 (80%)	175 (84%)	33 (16%)	1 (0%)	29	61
26	cb	74/82 (90%)	67 (90%)	7 (10%)	0	100	100
27	db	93/156 (60%)	88 (95%)	5 (5%)	0	100	100
28	eb	179/195 (92%)	160 (89%)	19 (11%)	0	100	100
29	fb	212/274 (77%)	194 (92%)	18 (8%)	0	100	100
30	gb	147/250 (59%)	133 (90%)	14 (10%)	0	100	100
31	hb	167/192 (87%)	143 (86%)	22 (13%)	2 (1%)	13	41
32	ib	143/159 (90%)	135 (94%)	8 (6%)	0	100	100
33	AA	227/258 (88%)	208 (92%)	19 (8%)	0	100	100
34	BA	154/164 (94%)	143 (93%)	11 (7%)	0	100	100
35	CA	134/137 (98%)	122 (91%)	12 (9%)	0	100	100
36	DA	249/261 (95%)	226 (91%)	23 (9%)	0	100	100

*Continued on next page...*

*Continued from previous page...*

Mol	Chain	Analysed	Favoured	Allowed	Outliers	Percentiles	
37	EA	162/180 (90%)	141 (87%)	21 (13%)	0	100	100
38	FA	183/189 (97%)	168 (92%)	15 (8%)	0	100	100
39	GA	127/140 (91%)	114 (90%)	13 (10%)	0	100	100
40	HA	201/204 (98%)	180 (90%)	21 (10%)	0	100	100
41	IA	142/145 (98%)	131 (92%)	11 (8%)	0	100	100
42	JA	184/187 (98%)	172 (94%)	12 (6%)	0	100	100
43	KA	269/301 (89%)	251 (93%)	18 (7%)	0	100	100
44	LA	168/213 (79%)	161 (96%)	7 (4%)	0	100	100
45	MA	153/170 (90%)	147 (96%)	6 (4%)	0	100	100
46	NA	114/152 (75%)	105 (92%)	9 (8%)	0	100	100
47	OA	59/162 (36%)	55 (93%)	4 (7%)	0	100	100
48	PA	128/157 (82%)	117 (91%)	11 (9%)	0	100	100
49	QA	140/147 (95%)	130 (93%)	10 (7%)	0	100	100
50	RA	96/112 (86%)	93 (97%)	3 (3%)	0	100	100
51	SA	105/123 (85%)	97 (92%)	8 (8%)	0	100	100
52	TA	124/133 (93%)	116 (94%)	8 (6%)	0	100	100
53	UA	78/93 (84%)	70 (90%)	8 (10%)	0	100	100
54	VA	48/76 (63%)	46 (96%)	2 (4%)	0	100	100
55	WA	96/105 (91%)	86 (90%)	10 (10%)	0	100	100
56	XA	130/135 (96%)	122 (94%)	8 (6%)	0	100	100
57	YA	175/178 (98%)	163 (93%)	12 (7%)	0	100	100
58	ZA	99/130 (76%)	81 (82%)	15 (15%)	3 (3%)	4	23
59	AB	98/112 (88%)	94 (96%)	4 (4%)	0	100	100
60	BB	117/124 (94%)	105 (90%)	12 (10%)	0	100	100
61	CB	232/244 (95%)	217 (94%)	15 (6%)	0	100	100
62	DB	382/389 (98%)	360 (94%)	22 (6%)	0	100	100
63	EB	397/404 (98%)	355 (89%)	41 (10%)	1 (0%)	41	72
64	FB	203/206 (98%)	193 (95%)	10 (5%)	0	100	100
65	GB	89/92 (97%)	83 (93%)	6 (7%)	0	100	100
66	HB	201/217 (93%)	186 (92%)	15 (8%)	0	100	100
67	IB	23/25 (92%)	23 (100%)	0	0	100	100

*Continued on next page...*

Continued from previous page...

Mol	Chain	Analysed	Favoured	Allowed	Outliers	Percentiles	
68	JB	49/129 (38%)	44 (90%)	5 (10%)	0	100	100
69	KB	203/208 (98%)	187 (92%)	13 (6%)	3 (2%)	10	36
70	LB	213/219 (97%)	191 (90%)	22 (10%)	0	100	100
71	MB	108/112 (96%)	101 (94%)	7 (6%)	0	100	100
72	NB	66/69 (96%)	58 (88%)	8 (12%)	0	100	100
73	OB	48/60 (80%)	43 (90%)	5 (10%)	0	100	100
74	PB	106/119 (89%)	97 (92%)	9 (8%)	0	100	100
79	bl	435/437 (100%)	382 (88%)	53 (12%)	0	100	100
All	All	11017/12722 (87%)	10026 (91%)	980 (9%)	11 (0%)	54	82

All (11) Ramachandran outliers are listed below:

Mol	Chain	Res	Type
31	hb	77	HIS
58	ZA	110	GLU
69	KB	63	ARG
20	va	54	PRO
25	bb	55	LYS
31	hb	66	PRO
58	ZA	109	LYS
63	EB	359	ASN
69	KB	4	HIS
58	ZA	99	ARG
69	KB	62	THR

### 5.3.2 Protein sidechains [i](#)

In the following table, the Percentiles column shows the percent sidechain outliers of the chain as a percentile score with respect to all PDB entries followed by that with respect to all EM entries.

The Analysed column shows the number of residues for which the sidechain conformation was analysed, and the total number of residues.

Mol	Chain	Analysed	Rotameric	Outliers	Percentiles	
2	ba	99/116 (85%)	97 (98%)	2 (2%)	55	77
3	ca	153/181 (84%)	153 (100%)	0	100	100
4	da	77/143 (54%)	77 (100%)	0	100	100

Continued on next page...

*Continued from previous page...*

Mol	Chain	Analysed	Rotameric	Outliers	Percentiles	
5	ga	109/113 (96%)	109 (100%)	0	100	100
6	ha	274/281 (98%)	274 (100%)	0	100	100
7	ia	180/192 (94%)	180 (100%)	0	100	100
8	ja	222/224 (99%)	222 (100%)	0	100	100
9	ka	163/169 (96%)	163 (100%)	0	100	100
10	la	113/120 (94%)	113 (100%)	0	100	100
11	ma	97/115 (84%)	97 (100%)	0	100	100
12	na	98/121 (81%)	96 (98%)	2 (2%)	55	77
13	oa	119/133 (90%)	118 (99%)	1 (1%)	81	91
14	pa	129/130 (99%)	129 (100%)	0	100	100
15	qa	108/126 (86%)	106 (98%)	2 (2%)	57	78
16	ra	112/124 (90%)	112 (100%)	0	100	100
17	sa	87/130 (67%)	86 (99%)	1 (1%)	73	86
18	ta	69/92 (75%)	68 (99%)	1 (1%)	67	83
19	ua	57/78 (73%)	57 (100%)	0	100	100
20	va	110/111 (99%)	110 (100%)	0	100	100
21	wa	34/47 (72%)	33 (97%)	1 (3%)	42	69
22	xa	64/78 (82%)	63 (98%)	1 (2%)	62	81
23	ya	32/49 (65%)	31 (97%)	1 (3%)	40	68
24	za	172/233 (74%)	172 (100%)	0	100	100
25	bb	189/228 (83%)	189 (100%)	0	100	100
26	cb	63/68 (93%)	63 (100%)	0	100	100
27	db	82/113 (73%)	82 (100%)	0	100	100
28	eb	154/162 (95%)	154 (100%)	0	100	100
29	fb	181/219 (83%)	181 (100%)	0	100	100
30	gb	130/215 (60%)	129 (99%)	1 (1%)	81	91
31	hb	151/171 (88%)	151 (100%)	0	100	100
32	ib	126/132 (96%)	125 (99%)	1 (1%)	81	91
33	AA	200/222 (90%)	200 (100%)	0	100	100
34	BA	135/141 (96%)	135 (100%)	0	100	100
35	CA	113/114 (99%)	113 (100%)	0	100	100

*Continued on next page...*

*Continued from previous page...*

Mol	Chain	Analysed	Rotameric	Outliers	Percentiles	
36	DA	193/199 (97%)	193 (100%)	0	100	100
37	EA	142/156 (91%)	142 (100%)	0	100	100
38	FA	159/163 (98%)	159 (100%)	0	100	100
39	GA	103/109 (94%)	101 (98%)	2 (2%)	57	78
40	HA	177/178 (99%)	177 (100%)	0	100	100
41	IA	113/114 (99%)	113 (100%)	0	100	100
42	JA	156/157 (99%)	156 (100%)	0	100	100
43	KA	227/252 (90%)	227 (100%)	0	100	100
44	LA	150/176 (85%)	150 (100%)	0	100	100
45	MA	132/144 (92%)	130 (98%)	2 (2%)	65	82
46	NA	104/128 (81%)	104 (100%)	0	100	100
47	OA	55/133 (41%)	54 (98%)	1 (2%)	59	79
48	PA	115/130 (88%)	115 (100%)	0	100	100
49	QA	127/132 (96%)	127 (100%)	0	100	100
50	RA	86/98 (88%)	85 (99%)	1 (1%)	71	85
51	SA	94/108 (87%)	94 (100%)	0	100	100
52	TA	114/121 (94%)	114 (100%)	0	100	100
53	UA	69/77 (90%)	69 (100%)	0	100	100
54	VA	47/73 (64%)	47 (100%)	0	100	100
55	WA	87/93 (94%)	87 (100%)	0	100	100
56	XA	114/115 (99%)	114 (100%)	0	100	100
57	YA	162/163 (99%)	162 (100%)	0	100	100
58	ZA	89/106 (84%)	89 (100%)	0	100	100
59	AB	86/92 (94%)	86 (100%)	0	100	100
60	BB	105/109 (96%)	105 (100%)	0	100	100
61	CB	199/205 (97%)	199 (100%)	0	100	100
62	DB	332/336 (99%)	331 (100%)	1 (0%)	92	97
63	EB	317/321 (99%)	315 (99%)	2 (1%)	86	94
64	FB	172/173 (99%)	172 (100%)	0	100	100
65	GB	72/73 (99%)	72 (100%)	0	100	100
66	HB	170/178 (96%)	169 (99%)	1 (1%)	86	94

*Continued on next page...*



Continued from previous page...

Mol	Chain	Analysed	Rotameric	Outliers	Percentiles	
67	IB	24/24 (100%)	24 (100%)	0	100	100
68	JB	46/115 (40%)	46 (100%)	0	100	100
69	KB	175/178 (98%)	175 (100%)	0	100	100
70	LB	182/185 (98%)	181 (100%)	1 (0%)	88	94
71	MB	91/93 (98%)	91 (100%)	0	100	100
72	NB	62/63 (98%)	61 (98%)	1 (2%)	62	81
73	OB	44/51 (86%)	43 (98%)	1 (2%)	50	74
74	PB	96/107 (90%)	95 (99%)	1 (1%)	76	88
79	bl	378/378 (100%)	376 (100%)	2 (0%)	88	94
All	All	9568/10697 (89%)	9538 (100%)	30 (0%)	92	97

All (30) residues with a non-rotameric sidechain are listed below:

Mol	Chain	Res	Type
2	ba	51	LYS
2	ba	110	ARG
12	na	86	LYS
12	na	142	ARG
13	oa	73	ASN
15	qa	72	LYS
15	qa	88	LYS
17	sa	60	ARG
18	ta	104	ARG
21	wa	40	ARG
22	xa	84	LYS
23	ya	43	ARG
30	gb	15	LYS
32	ib	68	ARG
39	GA	15	ARG
39	GA	48	ARG
45	MA	10	ASN
45	MA	154	LYS
47	OA	59	LYS
50	RA	19	GLN
62	DB	359	LYS
63	EB	143	ARG
63	EB	227	ASN
66	HB	169	ARG
70	LB	97	LYS

Continued on next page...

*Continued from previous page...*

Mol	Chain	Res	Type
72	NB	9	LYS
73	OB	42	ASN
74	PB	4	ARG
79	bl	239	GLN
79	bl	421	ARG

Sometimes sidechains can be flipped to improve hydrogen bonding and reduce clashes. All (50) such sidechains are listed below:

Mol	Chain	Res	Type
2	ba	59	ASN
3	ca	112	GLN
4	da	39	ASN
5	ga	109	HIS
6	ha	127	ASN
8	ja	112	HIS
8	ja	214	GLN
10	la	100	GLN
14	pa	45	GLN
15	qa	74	GLN
18	ta	96	HIS
19	ua	46	GLN
20	va	48	ASN
20	va	55	HIS
20	va	107	ASN
20	va	118	GLN
24	za	17	GLN
25	bb	28	GLN
25	bb	160	GLN
27	db	54	GLN
28	eb	112	GLN
28	eb	126	HIS
28	eb	135	HIS
29	fb	162	HIS
30	gb	59	GLN
32	ib	139	ASN
33	AA	141	GLN
37	EA	111	HIS
37	EA	154	GLN
40	HA	23	GLN
41	IA	40	HIS
43	KA	156	ASN
45	MA	10	ASN

*Continued on next page...*

*Continued from previous page...*

Mol	Chain	Res	Type
46	NA	116	GLN
47	OA	13	GLN
48	PA	71	GLN
48	PA	95	ASN
52	TA	115	GLN
55	WA	75	GLN
57	YA	35	ASN
60	BB	49	HIS
60	BB	76	ASN
62	DB	103	ASN
62	DB	149	GLN
64	FB	135	GLN
64	FB	138	HIS
66	HB	144	ASN
67	IB	22	GLN
69	KB	4	HIS
69	KB	103	ASN

### 5.3.3 RNA [i](#)

Mol	Chain	Analysed	Backbone Outliers	Pucker Outliers
1	aa	1690/1810 (93%)	513 (30%)	0
75	RB	3143/3386 (92%)	732 (23%)	50 (1%)
76	SB	159/160 (99%)	36 (22%)	0
77	TB	119/120 (99%)	16 (13%)	2 (1%)
78	al	6/7 (85%)	3 (50%)	0
80	cl	73/75 (97%)	31 (42%)	0
All	All	5190/5558 (93%)	1331 (25%)	52 (1%)

All (1331) RNA backbone outliers are listed below:

Mol	Chain	Res	Type
1	aa	2	A
1	aa	4	C
1	aa	6	G
1	aa	25	C
1	aa	26	A
1	aa	27	U
1	aa	34	G
1	aa	40	A
1	aa	42	G

*Continued on next page...*

*Continued from previous page...*

<b>Mol</b>	<b>Chain</b>	<b>Res</b>	<b>Type</b>
1	aa	45	U
1	aa	46	A
1	aa	47	A
1	aa	50	C
1	aa	59	G
1	aa	62	A
1	aa	63	G
1	aa	66	U
1	aa	67	G
1	aa	68	A
1	aa	72	A
1	aa	73	A
1	aa	74	U
1	aa	76	U
1	aa	77	G
1	aa	78	A
1	aa	79	A
1	aa	80	C
1	aa	81	U
1	aa	84	G
1	aa	96	G
1	aa	101	A
1	aa	105	A
1	aa	106	A
1	aa	114	U
1	aa	115	A
1	aa	116	G
1	aa	117	U
1	aa	128	G
1	aa	129	U
1	aa	130	A
1	aa	131	C
1	aa	132	G
1	aa	133	U
1	aa	134	G
1	aa	135	C
1	aa	136	U
1	aa	137	A
1	aa	138	C
1	aa	139	U
1	aa	140	C
1	aa	141	G

*Continued on next page...*

*Continued from previous page...*

<b>Mol</b>	<b>Chain</b>	<b>Res</b>	<b>Type</b>
1	aa	143	A
1	aa	144	U
1	aa	145	A
1	aa	154	A
1	aa	156	U
1	aa	158	C
1	aa	164	C
1	aa	172	U
1	aa	175	A
1	aa	176	A
1	aa	177	C
1	aa	179	A
1	aa	180	A
1	aa	181	C
1	aa	184	C
1	aa	187	C
1	aa	189	U
1	aa	190	C
1	aa	191	U
1	aa	192	G
1	aa	193	G
1	aa	195	A
1	aa	196	G
1	aa	197	G
1	aa	198	G
1	aa	199	G
1	aa	200	C
1	aa	201	G
1	aa	203	A
1	aa	212	A
1	aa	213	U
1	aa	244	C
1	aa	245	C
1	aa	252	U
1	aa	253	C
1	aa	260	A
1	aa	263	C
1	aa	264	G
1	aa	265	A
1	aa	268	G
1	aa	272	G
1	aa	273	C

*Continued on next page...*

*Continued from previous page...*

<b>Mol</b>	<b>Chain</b>	<b>Res</b>	<b>Type</b>
1	aa	274	A
1	aa	275	C
1	aa	276	G
1	aa	277	G
1	aa	280	U
1	aa	281	U
1	aa	282	C
1	aa	283	G
1	aa	284	U
1	aa	285	G
1	aa	287	C
1	aa	288	G
1	aa	303	A
1	aa	306	U
1	aa	308	U
1	aa	317	U
1	aa	318	C
1	aa	320	A
1	aa	325	C
1	aa	326	G
1	aa	341	G
1	aa	342	C
1	aa	354	G
1	aa	355	U
1	aa	356	G
1	aa	363	G
1	aa	365	C
1	aa	384	U
1	aa	388	G
1	aa	391	A
1	aa	392	G
1	aa	397	C
1	aa	404	A
1	aa	405	A
1	aa	406	C
1	aa	407	G
1	aa	408	G
1	aa	420	A
1	aa	421	A
1	aa	422	G
1	aa	423	G
1	aa	428	C

*Continued on next page...*

*Continued from previous page...*

<b>Mol</b>	<b>Chain</b>	<b>Res</b>	<b>Type</b>
1	aa	429	A
1	aa	430	G
1	aa	438	G
1	aa	439	C
1	aa	443	U
1	aa	444	U
1	aa	448	C
1	aa	458	A
1	aa	465	G
1	aa	466	G
1	aa	472	A
1	aa	474	A
1	aa	481	A
1	aa	485	A
1	aa	486	U
1	aa	487	A
1	aa	488	C
1	aa	489	C
1	aa	490	G
1	aa	492	G
1	aa	494	G
1	aa	495	C
1	aa	498	U
1	aa	499	A
1	aa	500	G
1	aa	501	U
1	aa	502	G
1	aa	505	U
1	aa	506	G
1	aa	508	U
1	aa	509	A
1	aa	510	A
1	aa	511	U
1	aa	512	U
1	aa	514	G
1	aa	515	A
1	aa	518	G
1	aa	523	C
1	aa	529	A
1	aa	531	A
1	aa	536	U
1	aa	537	U

*Continued on next page...*

*Continued from previous page...*

<b>Mol</b>	<b>Chain</b>	<b>Res</b>	<b>Type</b>
1	aa	538	A
1	aa	544	G
1	aa	545	A
1	aa	546	U
1	aa	552	G
1	aa	553	G
1	aa	559	A
1	aa	560	A
1	aa	561	G
1	aa	562	U
1	aa	563	C
1	aa	565	G
1	aa	569	C
1	aa	570	C
1	aa	583	A
1	aa	584	A
1	aa	587	C
1	aa	598	A
1	aa	599	G
1	aa	610	A
1	aa	615	U
1	aa	624	A
1	aa	626	A
1	aa	627	A
1	aa	628	G
1	aa	633	U
1	aa	634	A
1	aa	638	G
1	aa	639	G
1	aa	642	C
1	aa	643	U
1	aa	644	U
1	aa	645	G
1	aa	646	G
1	aa	650	G
1	aa	651	G
1	aa	704	C
1	aa	706	U
1	aa	707	C
1	aa	708	G
1	aa	709	C
1	aa	714	C

*Continued on next page...*



*Continued from previous page...*

<b>Mol</b>	<b>Chain</b>	<b>Res</b>	<b>Type</b>
1	aa	715	U
1	aa	716	A
1	aa	717	G
1	aa	718	C
1	aa	745	C
1	aa	746	A
1	aa	747	U
1	aa	748	C
1	aa	749	G
1	aa	751	U
1	aa	760	G
1	aa	761	A
1	aa	762	A
1	aa	772	C
1	aa	776	A
1	aa	777	A
1	aa	780	A
1	aa	781	A
1	aa	783	C
1	aa	784	C
1	aa	785	A
1	aa	786	U
1	aa	787	C
1	aa	788	G
1	aa	789	C
1	aa	792	U
1	aa	795	A
1	aa	800	U
1	aa	809	G
1	aa	814	C
1	aa	817	C
1	aa	818	A
1	aa	820	A
1	aa	821	G
1	aa	822	G
1	aa	825	U
1	aa	827	C
1	aa	828	G
1	aa	829	G
1	aa	831	C
1	aa	833	U
1	aa	834	A

*Continued on next page...*

*Continued from previous page...*

<b>Mol</b>	<b>Chain</b>	<b>Res</b>	<b>Type</b>
1	aa	835	U
1	aa	836	U
1	aa	837	G
1	aa	838	U
1	aa	840	U
1	aa	842	G
1	aa	846	U
1	aa	851	G
1	aa	853	U
1	aa	855	G
1	aa	857	A
1	aa	859	U
1	aa	861	A
1	aa	862	U
1	aa	864	A
1	aa	865	U
1	aa	866	U
1	aa	868	A
1	aa	869	U
1	aa	897	A
1	aa	903	A
1	aa	911	A
1	aa	918	G
1	aa	919	G
1	aa	920	A
1	aa	931	A
1	aa	933	G
1	aa	936	C
1	aa	938	A
1	aa	940	U
1	aa	947	G
1	aa	949	A
1	aa	950	U
1	aa	965	U
1	aa	971	A
1	aa	991	G
1	aa	993	C
1	aa	997	A
1	aa	1009	U
1	aa	1010	A
1	aa	1028	A
1	aa	1029	U

*Continued on next page...*

*Continued from previous page...*

<b>Mol</b>	<b>Chain</b>	<b>Res</b>	<b>Type</b>
1	aa	1031	A
1	aa	1033	C
1	aa	1034	G
1	aa	1035	A
1	aa	1037	G
1	aa	1044	A
1	aa	1045	G
1	aa	1056	A
1	aa	1057	U
1	aa	1058	G
1	aa	1059	U
1	aa	1061	G
1	aa	1062	C
1	aa	1063	U
1	aa	1064	U
1	aa	1065	A
1	aa	1076	C
1	aa	1077	C
1	aa	1079	G
1	aa	1081	A
1	aa	1086	A
1	aa	1087	U
1	aa	1095	C
1	aa	1096	A
1	aa	1097	A
1	aa	1098	A
1	aa	1101	C
1	aa	1102	U
1	aa	1103	U
1	aa	1105	G
1	aa	1114	G
1	aa	1116	G
1	aa	1118	A
1	aa	1131	G
1	aa	1143	A
1	aa	1145	G
1	aa	1155	G
1	aa	1156	A
1	aa	1162	A
1	aa	1163	C
1	aa	1164	C
1	aa	1165	A

*Continued on next page...*

*Continued from previous page...*

<b>Mol</b>	<b>Chain</b>	<b>Res</b>	<b>Type</b>
1	aa	1168	A
1	aa	1169	G
1	aa	1172	G
1	aa	1175	G
1	aa	1178	C
1	aa	1188	A
1	aa	1189	U
1	aa	1190	U
1	aa	1197	A
1	aa	1198	A
1	aa	1200	A
1	aa	1203	G
1	aa	1204	G
1	aa	1206	A
1	aa	1208	A
1	aa	1211	U
1	aa	1221	A
1	aa	1222	G
1	aa	1232	G
1	aa	1233	G
1	aa	1234	A
1	aa	1235	U
1	aa	1238	A
1	aa	1245	G
1	aa	1246	A
1	aa	1248	A
1	aa	1249	G
1	aa	1250	C
1	aa	1254	U
1	aa	1255	U
1	aa	1256	C
1	aa	1258	U
1	aa	1262	U
1	aa	1269	G
1	aa	1288	C
1	aa	1290	U
1	aa	1305	U
1	aa	1311	U
1	aa	1318	U
1	aa	1319	U
1	aa	1320	C
1	aa	1325	A

*Continued on next page...*

*Continued from previous page...*

<b>Mol</b>	<b>Chain</b>	<b>Res</b>	<b>Type</b>
1	aa	1344	U
1	aa	1348	A
1	aa	1349	A
1	aa	1350	C
1	aa	1351	U
1	aa	1352	A
1	aa	1354	C
1	aa	1358	G
1	aa	1359	C
1	aa	1360	G
1	aa	1361	G
1	aa	1362	A
1	aa	1364	C
1	aa	1365	C
1	aa	1366	A
1	aa	1367	U
1	aa	1368	C
1	aa	1370	C
1	aa	1377	G
1	aa	1378	C
1	aa	1379	U
1	aa	1381	G
1	aa	1382	C
1	aa	1386	U
1	aa	1391	G
1	aa	1394	A
1	aa	1396	U
1	aa	1399	G
1	aa	1404	U
1	aa	1405	U
1	aa	1419	U
1	aa	1420	U
1	aa	1421	U
1	aa	1424	G
1	aa	1428	A
1	aa	1431	A
1	aa	1433	A
1	aa	1434	G
1	aa	1437	C
1	aa	1438	U
1	aa	1442	A
1	aa	1451	G

*Continued on next page...*

*Continued from previous page...*

<b>Mol</b>	<b>Chain</b>	<b>Res</b>	<b>Type</b>
1	aa	1452	A
1	aa	1464	G
1	aa	1465	C
1	aa	1477	A
1	aa	1488	C
1	aa	1491	C
1	aa	1492	G
1	aa	1495	U
1	aa	1496	A
1	aa	1497	U
1	aa	1498	A
1	aa	1499	U
1	aa	1500	A
1	aa	1501	G
1	aa	1502	C
1	aa	1504	U
1	aa	1514	G
1	aa	1515	G
1	aa	1519	G
1	aa	1522	U
1	aa	1524	A
1	aa	1527	U
1	aa	1529	G
1	aa	1530	G
1	aa	1532	A
1	aa	1543	U
1	aa	1544	G
1	aa	1545	A
1	aa	1547	G
1	aa	1550	G
1	aa	1556	U
1	aa	1562	C
1	aa	1563	A
1	aa	1565	U
1	aa	1566	U
1	aa	1567	G
1	aa	1571	G
1	aa	1573	C
1	aa	1577	A
1	aa	1579	C
1	aa	1582	G
1	aa	1590	U

*Continued on next page...*

*Continued from previous page...*

<b>Mol</b>	<b>Chain</b>	<b>Res</b>	<b>Type</b>
1	aa	1591	A
1	aa	1592	G
1	aa	1598	G
1	aa	1609	G
1	aa	1624	G
1	aa	1630	G
1	aa	1639	A
1	aa	1643	A
1	aa	1647	C
1	aa	1659	A
1	aa	1664	U
1	aa	1665	U
1	aa	1666	G
1	aa	1682	U
1	aa	1691	C
1	aa	1692	G
1	aa	1694	G
1	aa	1696	C
1	aa	1698	A
1	aa	1699	C
1	aa	1722	C
1	aa	1725	C
1	aa	1726	G
1	aa	1727	C
1	aa	1741	A
1	aa	1757	G
1	aa	1766	A
1	aa	1767	G
1	aa	1770	G
1	aa	1771	U
1	aa	1772	A
1	aa	1776	A
1	aa	1779	U
1	aa	1783	C
1	aa	1790	G
1	aa	1792	A
1	aa	1802	G
1	aa	1803	G
1	aa	1804	A
1	aa	1806	C
1	aa	1809	U
1	aa	1810	G

*Continued on next page...*

*Continued from previous page...*

<b>Mol</b>	<b>Chain</b>	<b>Res</b>	<b>Type</b>
75	RB	2	C
75	RB	3	G
75	RB	4	C
75	RB	6	A
75	RB	10	C
75	RB	12	G
75	RB	13	G
75	RB	21	G
75	RB	25	U
75	RB	39	A
75	RB	42	A
75	RB	43	U
75	RB	44	A
75	RB	48	A
75	RB	49	U
75	RB	54	G
75	RB	58	G
75	RB	59	A
75	RB	64	A
75	RB	65	A
75	RB	73	A
75	RB	89	C
75	RB	91	G
75	RB	98	A
75	RB	104	G
75	RB	108	A
75	RB	109	G
75	RB	113	A
75	RB	115	C
75	RB	117	U
75	RB	119	A
75	RB	120	G
75	RB	121	A
75	RB	133	G
75	RB	134	U
75	RB	135	G
75	RB	141	C
75	RB	155	G
75	RB	156	A
75	RB	160	G
75	RB	163	U
75	RB	164	C

*Continued on next page...*



*Continued from previous page...*

<b>Mol</b>	<b>Chain</b>	<b>Res</b>	<b>Type</b>
75	RB	171	G
75	RB	174	G
75	RB	188	U
75	RB	198	A
75	RB	199	G
75	RB	204	G
75	RB	208	G
75	RB	209	G
75	RB	216	G
75	RB	217	A
75	RB	219	A
75	RB	222	C
75	RB	229	G
75	RB	237	C
75	RB	238	C
75	RB	241	G
75	RB	245	C
75	RB	247	C
75	RB	250	C
75	RB	267	G
75	RB	268	U
75	RB	279	G
75	RB	282	A
75	RB	284	U
75	RB	293	A
75	RB	296	C
75	RB	321	A
75	RB	327	A
75	RB	332	A
75	RB	347	A
75	RB	349	A
75	RB	350	A
75	RB	360	G
75	RB	370	A
75	RB	372	A
75	RB	373	A
75	RB	374	G
75	RB	396	G
75	RB	397	A
75	RB	399	U
75	RB	400	G
75	RB	402	U

*Continued on next page...*

*Continued from previous page...*

<b>Mol</b>	<b>Chain</b>	<b>Res</b>	<b>Type</b>
75	RB	419	G
75	RB	424	G
75	RB	426	A
75	RB	427	U
75	RB	428	G
75	RB	431	G
75	RB	435	G
75	RB	437	C
75	RB	439	A
75	RB	440	U
75	RB	442	C
75	RB	443	G
75	RB	444	C
75	RB	446	C
75	RB	448	G
75	RB	449	G
75	RB	450	C
75	RB	488	U
75	RB	490	G
75	RB	492	G
75	RB	493	G
75	RB	494	C
75	RB	495	G
75	RB	497	G
75	RB	499	A
75	RB	508	G
75	RB	523	C
75	RB	524	A
75	RB	526	A
75	RB	529	C
75	RB	536	C
75	RB	538	C
75	RB	539	C
75	RB	540	G
75	RB	541	C
75	RB	551	A
75	RB	552	G
75	RB	554	C
75	RB	555	G
75	RB	564	A
75	RB	573	A
75	RB	574	C

*Continued on next page...*

*Continued from previous page...*

<b>Mol</b>	<b>Chain</b>	<b>Res</b>	<b>Type</b>
75	RB	575	C
75	RB	581	G
75	RB	586	A
75	RB	587	A
75	RB	588	G
75	RB	591	G
75	RB	593	G
75	RB	594	C
75	RB	595	C
75	RB	597	C
75	RB	599	C
75	RB	600	G
75	RB	601	G
75	RB	607	U
75	RB	608	G
75	RB	610	G
75	RB	613	G
75	RB	614	C
75	RB	622	U
75	RB	624	C
75	RB	627	G
75	RB	628	C
75	RB	629	U
75	RB	630	C
75	RB	640	C
75	RB	648	G
75	RB	653	A
75	RB	680	G
75	RB	681	A
75	RB	685	G
75	RB	686	A
75	RB	691	U
75	RB	694	U
75	RB	695	G
75	RB	704	G
75	RB	706	U
75	RB	711	A
75	RB	714	G
75	RB	718	C
75	RB	721	A
75	RB	722	C
75	RB	723	G

*Continued on next page...*

*Continued from previous page...*

<b>Mol</b>	<b>Chain</b>	<b>Res</b>	<b>Type</b>
75	RB	724	A
75	RB	729	G
75	RB	740	G
75	RB	770	U
75	RB	777	G
75	RB	780	U
75	RB	783	A
75	RB	784	G
75	RB	787	G
75	RB	788	G
75	RB	789	A
75	RB	809	A
75	RB	812	G
75	RB	820	A
75	RB	833	G
75	RB	835	G
75	RB	850	A
75	RB	852	C
75	RB	864	C
75	RB	867	G
75	RB	877	U
75	RB	882	U
75	RB	883	G
75	RB	897	U
75	RB	898	G
75	RB	899	A
75	RB	910	G
75	RB	911	G
75	RB	917	A
75	RB	919	G
75	RB	920	A
75	RB	927	G
75	RB	940	G
75	RB	944	G
75	RB	947	C
75	RB	962	C
75	RB	963	U
75	RB	965	A
75	RB	966	G
75	RB	968	A
75	RB	977	G
75	RB	982	U

*Continued on next page...*

*Continued from previous page...*

<b>Mol</b>	<b>Chain</b>	<b>Res</b>	<b>Type</b>
75	RB	986	G
75	RB	996	A
75	RB	998	G
75	RB	1004	C
75	RB	1006	A
75	RB	1019	A
75	RB	1020	U
75	RB	1022	G
75	RB	1023	G
75	RB	1024	G
75	RB	1026	A
75	RB	1028	G
75	RB	1029	C
75	RB	1030	A
75	RB	1033	G
75	RB	1034	U
75	RB	1035	C
75	RB	1036	C
75	RB	1037	U
75	RB	1039	G
75	RB	1040	A
75	RB	1049	C
75	RB	1051	A
75	RB	1053	C
75	RB	1054	U
75	RB	1055	U
75	RB	1060	U
75	RB	1068	A
75	RB	1069	U
75	RB	1079	G
75	RB	1085	G
75	RB	1087	G
75	RB	1096	C
75	RB	1099	G
75	RB	1100	G
75	RB	1101	A
75	RB	1106	G
75	RB	1108	U
75	RB	1109	G
75	RB	1120	G
75	RB	1134	G
75	RB	1143	G

*Continued on next page...*

*Continued from previous page...*

<b>Mol</b>	<b>Chain</b>	<b>Res</b>	<b>Type</b>
75	RB	1146	A
75	RB	1153	A
75	RB	1156	A
75	RB	1157	A
75	RB	1162	A
75	RB	1177	G
75	RB	1184	U
75	RB	1187	G
75	RB	1194	C
75	RB	1195	C
75	RB	1196	U
75	RB	1197	A
75	RB	1201	C
75	RB	1203	C
75	RB	1205	C
75	RB	1206	A
75	RB	1217	G
75	RB	1220	G
75	RB	1224	A
75	RB	1225	A
75	RB	1226	G
75	RB	1227	A
75	RB	1231	C
75	RB	1234	G
75	RB	1235	A
75	RB	1236	C
75	RB	1238	G
75	RB	1239	U
75	RB	1240	G
75	RB	1241	G
75	RB	1242	U
75	RB	1243	C
75	RB	1244	A
75	RB	1246	G
75	RB	1248	A
75	RB	1249	A
75	RB	1250	G
75	RB	1251	U
75	RB	1252	C
75	RB	1253	G
75	RB	1254	A
75	RB	1258	C

*Continued on next page...*

*Continued from previous page...*

<b>Mol</b>	<b>Chain</b>	<b>Res</b>	<b>Type</b>
75	RB	1262	U
75	RB	1264	A
75	RB	1267	A
75	RB	1268	G
75	RB	1269	U
75	RB	1270	G
75	RB	1271	U
75	RB	1272	G
75	RB	1274	A
75	RB	1275	A
75	RB	1277	A
75	RB	1278	A
75	RB	1281	C
75	RB	1283	C
75	RB	1284	C
75	RB	1286	G
75	RB	1290	A
75	RB	1291	A
75	RB	1299	G
75	RB	1309	U
75	RB	1311	G
75	RB	1312	A
75	RB	1313	U
75	RB	1317	G
75	RB	1320	G
75	RB	1321	A
75	RB	1327	G
75	RB	1330	A
75	RB	1333	C
75	RB	1334	A
75	RB	1352	G
75	RB	1353	A
75	RB	1354	G
75	RB	1355	U
75	RB	1356	G
75	RB	1357	C
75	RB	1358	C
75	RB	1359	A
75	RB	1360	U
75	RB	1393	G
75	RB	1395	A
75	RB	1402	G

*Continued on next page...*

*Continued from previous page...*

<b>Mol</b>	<b>Chain</b>	<b>Res</b>	<b>Type</b>
75	RB	1405	G
75	RB	1422	G
75	RB	1424	G
75	RB	1432	G
75	RB	1437	G
75	RB	1439	U
75	RB	1440	C
75	RB	1449	A
75	RB	1453	G
75	RB	1455	A
75	RB	1484	A
75	RB	1485	A
75	RB	1486	G
75	RB	1487	A
75	RB	1491	G
75	RB	1498	U
75	RB	1505	G
75	RB	1511	C
75	RB	1526	A
75	RB	1531	G
75	RB	1536	U
75	RB	1546	G
75	RB	1549	A
75	RB	1550	A
75	RB	1552	C
75	RB	1555	G
75	RB	1557	C
75	RB	1559	G
75	RB	1561	U
75	RB	1563	G
75	RB	1564	C
75	RB	1567	G
75	RB	1568	A
75	RB	1569	U
75	RB	1571	A
75	RB	1572	C
75	RB	1577	A
75	RB	1578	U
75	RB	1579	C
75	RB	1584	A
75	RB	1585	A
75	RB	1586	A

*Continued on next page...*



*Continued from previous page...*

<b>Mol</b>	<b>Chain</b>	<b>Res</b>	<b>Type</b>
75	RB	1590	A
75	RB	1593	C
75	RB	1602	A
75	RB	1603	U
75	RB	1604	U
75	RB	1605	U
75	RB	1617	A
75	RB	1626	U
75	RB	1627	U
75	RB	1636	C
75	RB	1639	U
75	RB	1640	A
75	RB	1642	G
75	RB	1644	A
75	RB	1645	G
75	RB	1654	C
75	RB	1689	G
75	RB	1702	C
75	RB	1714	A
75	RB	1715	C
75	RB	1716	G
75	RB	1718	U
75	RB	1722	G
75	RB	1723	C
75	RB	1728	G
75	RB	1740	U
75	RB	1748	A
75	RB	1749	G
75	RB	1750	A
75	RB	1756	C
75	RB	1759	C
75	RB	1760	G
75	RB	1761	C
75	RB	1762	G
75	RB	1769	C
75	RB	1771	G
75	RB	1774	G
75	RB	1776	G
75	RB	1792	G
75	RB	1793	A
75	RB	1811	U
75	RB	1812	A

*Continued on next page...*

*Continued from previous page...*

<b>Mol</b>	<b>Chain</b>	<b>Res</b>	<b>Type</b>
75	RB	1813	C
75	RB	1814	C
75	RB	1815	G
75	RB	1816	U
75	RB	1817	U
75	RB	1838	A
75	RB	1845	C
75	RB	1846	A
75	RB	1847	G
75	RB	1851	U
75	RB	1862	C
75	RB	1863	A
75	RB	1870	G
75	RB	1874	A
75	RB	1875	A
75	RB	1876	U
75	RB	1882	A
75	RB	1889	G
75	RB	1900	C
75	RB	1902	G
75	RB	1903	C
75	RB	1911	A
75	RB	1922	C
75	RB	1926	A
75	RB	1931	G
75	RB	1939	C
75	RB	2101	A
75	RB	2105	G
75	RB	2107	A
75	RB	2108	C
75	RB	2115	G
75	RB	2116	G
75	RB	2125	A
75	RB	2134	U
75	RB	2136	A
75	RB	2139	A
75	RB	2152	A
75	RB	2153	U
75	RB	2161	G
75	RB	2163	G
75	RB	2169	U
75	RB	2171	A

*Continued on next page...*

*Continued from previous page...*

<b>Mol</b>	<b>Chain</b>	<b>Res</b>	<b>Type</b>
75	RB	2176	A
75	RB	2180	G
75	RB	2199	G
75	RB	2200	A
75	RB	2206	A
75	RB	2216	A
75	RB	2218	U
75	RB	2237	A
75	RB	2242	G
75	RB	2243	G
75	RB	2249	A
75	RB	2252	A
75	RB	2263	A
75	RB	2265	G
75	RB	2266	G
75	RB	2272	A
75	RB	2274	A
75	RB	2275	U
75	RB	2276	G
75	RB	2277	C
75	RB	2278	C
75	RB	2279	U
75	RB	2281	G
75	RB	2291	U
75	RB	2299	C
75	RB	2300	G
75	RB	2301	C
75	RB	2303	U
75	RB	2306	A
75	RB	2307	U
75	RB	2308	G
75	RB	2316	G
75	RB	2320	U
75	RB	2327	U
75	RB	2329	U
75	RB	2340	U
75	RB	2365	A
75	RB	2366	A
75	RB	2367	C
75	RB	2368	G
75	RB	2376	C
75	RB	2386	G

*Continued on next page...*

*Continued from previous page...*

<b>Mol</b>	<b>Chain</b>	<b>Res</b>	<b>Type</b>
75	RB	2390	A
75	RB	2391	A
75	RB	2395	A
75	RB	2396	G
75	RB	2397	A
75	RB	2403	U
75	RB	2404	U
75	RB	2405	G
75	RB	2412	A
75	RB	2416	U
75	RB	2428	G
75	RB	2431	A
75	RB	2435	G
75	RB	2436	A
75	RB	2505	U
75	RB	2508	A
75	RB	2511	U
75	RB	2518	U
75	RB	2520	G
75	RB	2521	G
75	RB	2522	U
75	RB	2528	G
75	RB	2529	C
75	RB	2530	G
75	RB	2532	G
75	RB	2533	G
75	RB	2534	C
75	RB	2535	A
75	RB	2536	U
75	RB	2537	G
75	RB	2538	C
75	RB	2539	C
75	RB	2540	C
75	RB	2542	U
75	RB	2545	U
75	RB	2547	U
75	RB	2548	U
75	RB	2549	G
75	RB	2566	U
75	RB	2567	U
75	RB	2568	A
75	RB	2569	C

*Continued on next page...*

*Continued from previous page...*

<b>Mol</b>	<b>Chain</b>	<b>Res</b>	<b>Type</b>
75	RB	2578	U
75	RB	2579	C
75	RB	2582	G
75	RB	2583	G
75	RB	2590	A
75	RB	2603	G
75	RB	2604	G
75	RB	2611	G
75	RB	2618	G
75	RB	2623	C
75	RB	2624	A
75	RB	2632	A
75	RB	2634	A
75	RB	2635	A
75	RB	2644	A
75	RB	2649	U
75	RB	2653	A
75	RB	2669	G
75	RB	2671	A
75	RB	2674	G
75	RB	2676	A
75	RB	2677	A
75	RB	2685	U
75	RB	2686	G
75	RB	2688	A
75	RB	2691	A
75	RB	2693	A
75	RB	2700	A
75	RB	2701	A
75	RB	2711	G
75	RB	2724	A
75	RB	2725	G
75	RB	2726	U
75	RB	2749	U
75	RB	2750	G
75	RB	2769	U
75	RB	2774	G
75	RB	2775	G
75	RB	2793	G
75	RB	2794	U
75	RB	2796	A
75	RB	2797	G

*Continued on next page...*

*Continued from previous page...*

<b>Mol</b>	<b>Chain</b>	<b>Res</b>	<b>Type</b>
75	RB	2798	A
75	RB	2799	A
75	RB	2800	A
75	RB	2801	A
75	RB	2807	C
75	RB	2814	A
75	RB	2815	U
75	RB	2826	U
75	RB	2839	U
75	RB	2840	U
75	RB	2841	C
75	RB	2842	A
75	RB	2853	G
75	RB	2856	U
75	RB	2857	U
75	RB	2868	G
75	RB	2869	A
75	RB	2872	U
75	RB	2884	A
75	RB	2885	U
75	RB	2886	C
75	RB	2896	C
75	RB	2908	A
75	RB	2913	U
75	RB	2920	U
75	RB	2930	A
75	RB	2932	U
75	RB	2933	A
75	RB	2935	G
75	RB	2939	C
75	RB	2952	U
75	RB	2963	G
75	RB	2968	A
75	RB	2969	G
75	RB	2980	C
75	RB	2986	U
75	RB	2989	U
75	RB	2993	A
75	RB	2994	G
75	RB	3001	G
75	RB	3007	A
75	RB	3008	A

*Continued on next page...*

*Continued from previous page...*

<b>Mol</b>	<b>Chain</b>	<b>Res</b>	<b>Type</b>
75	RB	3017	A
75	RB	3024	G
75	RB	3026	G
75	RB	3051	C
75	RB	3054	C
75	RB	3055	G
75	RB	3070	G
75	RB	3074	G
75	RB	3082	A
75	RB	3087	A
75	RB	3088	C
75	RB	3095	C
75	RB	3097	G
75	RB	3111	C
75	RB	3118	A
75	RB	3126	A
75	RB	3127	U
75	RB	3129	C
75	RB	3137	C
75	RB	3138	A
75	RB	3139	U
75	RB	3149	G
75	RB	3150	C
75	RB	3157	C
75	RB	3158	G
75	RB	3161	C
75	RB	3168	A
75	RB	3172	A
75	RB	3176	U
75	RB	3178	G
75	RB	3185	U
75	RB	3186	U
75	RB	3187	G
75	RB	3189	G
75	RB	3190	C
75	RB	3193	C
75	RB	3194	C
75	RB	3195	A
75	RB	3196	A
75	RB	3197	G
75	RB	3202	C
75	RB	3203	G

*Continued on next page...*

*Continued from previous page...*

<b>Mol</b>	<b>Chain</b>	<b>Res</b>	<b>Type</b>
75	RB	3204	U
75	RB	3205	G
75	RB	3207	C
75	RB	3209	U
75	RB	3211	G
75	RB	3215	A
75	RB	3216	A
75	RB	3230	A
75	RB	3231	A
75	RB	3232	G
75	RB	3233	U
75	RB	3234	G
75	RB	3239	G
75	RB	3240	G
75	RB	3241	U
75	RB	3243	G
75	RB	3256	C
75	RB	3257	U
75	RB	3258	C
75	RB	3263	C
75	RB	3265	C
75	RB	3267	A
75	RB	3268	C
75	RB	3272	C
75	RB	3273	G
75	RB	3274	G
75	RB	3275	U
75	RB	3276	G
75	RB	3282	A
75	RB	3290	G
75	RB	3291	C
75	RB	3293	G
75	RB	3296	G
75	RB	3303	A
75	RB	3304	U
75	RB	3305	A
75	RB	3306	C
75	RB	3307	G
75	RB	3321	U
75	RB	3329	A
75	RB	3332	G
75	RB	3339	U

*Continued on next page...*



*Continued from previous page...*

<b>Mol</b>	<b>Chain</b>	<b>Res</b>	<b>Type</b>
75	RB	3340	G
75	RB	3342	U
75	RB	3343	G
75	RB	3350	U
75	RB	3355	U
75	RB	3356	G
75	RB	3362	C
75	RB	3365	U
75	RB	3370	G
75	RB	3371	G
75	RB	3372	G
75	RB	3374	C
75	RB	3375	G
75	RB	3377	A
75	RB	3378	C
75	RB	3379	G
75	RB	3380	G
75	RB	3386	U
76	SB	2	G
76	SB	34	U
76	SB	35	C
76	SB	51	G
76	SB	56	G
76	SB	59	A
76	SB	62	C
76	SB	63	C
76	SB	80	A
76	SB	81	U
76	SB	82	C
76	SB	83	C
76	SB	84	C
76	SB	85	G
76	SB	86	U
76	SB	87	G
76	SB	88	A
76	SB	90	C
76	SB	95	G
76	SB	97	G
76	SB	104	A
76	SB	105	A
76	SB	106	C
76	SB	107	G

*Continued on next page...*

*Continued from previous page...*

<b>Mol</b>	<b>Chain</b>	<b>Res</b>	<b>Type</b>
76	SB	111	G
76	SB	112	U
76	SB	116	G
76	SB	121	A
76	SB	122	G
76	SB	127	U
76	SB	128	C
76	SB	129	C
76	SB	130	G
76	SB	132	C
76	SB	140	A
76	SB	153	C
77	TB	7	G
77	TB	26	C
77	TB	38	U
77	TB	50	A
77	TB	51	G
77	TB	52	U
77	TB	53	U
77	TB	54	A
77	TB	64	G
77	TB	72	G
77	TB	74	A
77	TB	89	G
77	TB	100	A
77	TB	110	G
77	TB	119	C
77	TB	120	C
78	al	4	U
78	al	6	A
78	al	7	A
80	cl	7	G
80	cl	8	U
80	cl	10	2MG
80	cl	14	A
80	cl	15	G
80	cl	16	C
80	cl	18	G
80	cl	19	G
80	cl	20	A
80	cl	22	G
80	cl	26	2MG

*Continued on next page...*

*Continued from previous page...*

<b>Mol</b>	<b>Chain</b>	<b>Res</b>	<b>Type</b>
80	cl	31	G
80	cl	34	C
80	cl	42	A
80	cl	45	G
80	cl	46	G7M
80	cl	47	H2U
80	cl	48	5MC
80	cl	49	5MC
80	cl	52	G
80	cl	56	C
80	cl	58	1MA
80	cl	59	A
80	cl	60	A
80	cl	61	C
80	cl	64	G
80	cl	65	G
80	cl	68	C
80	cl	72	U
80	cl	74	C
80	cl	76	A

All (52) RNA pucker outliers are listed below:

<b>Mol</b>	<b>Chain</b>	<b>Res</b>	<b>Type</b>
75	RB	12	G
75	RB	427	U
75	RB	439	A
75	RB	449	G
75	RB	494	C
75	RB	522	C
75	RB	538	C
75	RB	550	C
75	RB	563	C
75	RB	607	U
75	RB	621	C
75	RB	690	G
75	RB	693	C
75	RB	703	G
75	RB	919	G
75	RB	962	C
75	RB	985	C
75	RB	997	G

*Continued on next page...*

*Continued from previous page...*

Mol	Chain	Res	Type
75	RB	1068	A
75	RB	1100	G
75	RB	1194	C
75	RB	1200	A
75	RB	1238	G
75	RB	1250	G
75	RB	1311	G
75	RB	1359	A
75	RB	1545	G
75	RB	1549	A
75	RB	1759	C
75	RB	1815	G
75	RB	1861	A
75	RB	2100	A
75	RB	2152	A
75	RB	2299	C
75	RB	2535	A
75	RB	2536	U
75	RB	2617	G
75	RB	2815	U
75	RB	2840	U
75	RB	2962	U
75	RB	2993	A
75	RB	3117	U
75	RB	3188	C
75	RB	3194	C
75	RB	3238	C
75	RB	3256	C
75	RB	3305	A
75	RB	3328	C
75	RB	3369	C
75	RB	3370	G
77	TB	51	G
77	TB	71	A

## 5.4 Non-standard residues in protein, DNA, RNA chains [i](#)

11 non-standard protein/DNA/RNA residues are modelled in this entry.

In the following table, the Counts columns list the number of bonds (or angles) for which Mogul statistics could be retrieved, the number of bonds (or angles) that are observed in the model and the number of bonds (or angles) that are defined in the Chemical Component Dictionary. The Link column lists molecule types, if any, to which the group is linked. The Z score for a bond

length (or angle) is the number of standard deviations the observed value is removed from the expected value. A bond length (or angle) with  $|Z| > 2$  is considered an outlier worth inspection. RMSZ is the root-mean-square of all Z scores of the bond lengths (or angles).

Mol	Type	Chain	Res	Link	Bond lengths			Bond angles		
					Counts	RMSZ	# Z  > 2	Counts	RMSZ	# Z  > 2
80	2MG	cl	10	80	18,26,27	2.62	6 (33%)	16,38,41	1.45	3 (18%)
80	5MC	cl	49	80	18,22,23	3.76	8 (44%)	26,32,35	1.39	4 (15%)
80	MIA	cl	37	80,81	24,31,32	2.23	3 (12%)	26,44,47	3.35	7 (26%)
80	1MG	cl	9	80	18,26,27	2.63	5 (27%)	19,39,42	1.50	4 (21%)
80	PSU	cl	55	80	18,21,22	1.11	2 (11%)	22,30,33	1.73	4 (18%)
80	PSU	cl	28	80	18,21,22	1.08	2 (11%)	22,30,33	1.84	4 (18%)
80	G7M	cl	46	80	20,26,27	2.73	8 (40%)	17,39,42	1.16	2 (11%)
80	1MA	cl	58	80	16,25,26	4.06	4 (25%)	18,37,40	1.65	3 (16%)
80	H2U	cl	47	80	18,21,22	3.05	5 (27%)	21,30,33	2.02	5 (23%)
80	2MG	cl	26	80	18,26,27	2.51	6 (33%)	16,38,41	1.37	4 (25%)
80	5MC	cl	48	80	18,22,23	3.73	8 (44%)	26,32,35	1.18	2 (7%)

In the following table, the Chirals column lists the number of chiral outliers, the number of chiral centers analysed, the number of these observed in the model and the number defined in the Chemical Component Dictionary. Similar counts are reported in the Torsion and Rings columns. '-' means no outliers of that kind were identified.

Mol	Type	Chain	Res	Link	Chirals	Torsions	Rings
80	2MG	cl	10	80	-	2/5/27/28	0/3/3/3
80	5MC	cl	49	80	-	4/7/25/26	0/2/2/2
80	MIA	cl	37	80,81	-	4/11/33/34	0/3/3/3
80	1MG	cl	9	80	-	0/3/25/26	0/3/3/3
80	PSU	cl	55	80	-	4/7/25/26	0/2/2/2
80	PSU	cl	28	80	-	0/7/25/26	0/2/2/2
80	G7M	cl	46	80	-	3/3/25/26	0/3/3/3
80	1MA	cl	58	80	-	2/3/25/26	0/3/3/3
80	H2U	cl	47	80	-	3/7/38/39	0/2/2/2
80	2MG	cl	26	80	-	2/5/27/28	0/3/3/3
80	5MC	cl	48	80	-	1/7/25/26	0/2/2/2

All (57) bond length outliers are listed below:

Mol	Chain	Res	Type	Atoms	Z	Observed(Å)	Ideal(Å)
80	cl	58	1MA	C2-N3	14.91	1.47	1.29

*Continued on next page...*

*Continued from previous page...*

Mol	Chain	Res	Type	Atoms	Z	Observed(Å)	Ideal(Å)
80	cl	47	H2U	C2-N1	9.52	1.49	1.35
80	cl	48	5MC	C6-C5	9.29	1.49	1.34
80	cl	49	5MC	C6-C5	9.14	1.49	1.34
80	cl	49	5MC	C4-N3	7.41	1.46	1.34
80	cl	48	5MC	C4-N3	7.20	1.46	1.34
80	cl	37	MIA	C6-N6	6.88	1.47	1.34
80	cl	37	MIA	C2-S10	6.63	1.81	1.75
80	cl	49	5MC	C2-N3	6.54	1.49	1.36
80	cl	9	1MG	C2-N3	6.48	1.46	1.34
80	cl	46	G7M	C2-N2	6.46	1.49	1.34
80	cl	48	5MC	C2-N3	6.26	1.49	1.36
80	cl	9	1MG	C2-N2	6.15	1.45	1.34
80	cl	47	H2U	C2-N3	6.14	1.48	1.38
80	cl	10	2MG	C2-N2	5.80	1.46	1.33
80	cl	26	2MG	C2-N2	5.62	1.45	1.33
80	cl	46	G7M	C2-N3	5.47	1.46	1.33
80	cl	10	2MG	C2-N1	5.25	1.45	1.36
80	cl	10	2MG	C4-N3	5.11	1.49	1.37
80	cl	48	5MC	C6-N1	5.08	1.46	1.38
80	cl	49	5MC	C6-N1	5.06	1.46	1.38
80	cl	26	2MG	C2-N1	5.05	1.44	1.36
80	cl	46	G7M	C4-N3	4.89	1.49	1.37
80	cl	9	1MG	C4-N3	4.83	1.49	1.37
80	cl	26	2MG	C4-N3	4.79	1.49	1.37
80	cl	47	H2U	C4-N3	4.74	1.45	1.37
80	cl	58	1MA	C2-N1	4.46	1.44	1.35
80	cl	49	5MC	C2-N1	4.42	1.49	1.40
80	cl	46	G7M	C6-N1	4.42	1.44	1.37
80	cl	48	5MC	C2-N1	4.27	1.49	1.40
80	cl	48	5MC	C4-N4	3.98	1.44	1.34
80	cl	49	5MC	C4-N4	3.98	1.44	1.34
80	cl	10	2MG	C6-N1	3.80	1.43	1.37
80	cl	58	1MA	C4-N3	3.62	1.48	1.37
80	cl	26	2MG	C6-N1	3.51	1.43	1.37
80	cl	55	PSU	C6-C5	3.43	1.39	1.35
80	cl	37	MIA	C5-C4	-3.23	1.32	1.40
80	cl	46	G7M	C5-C6	3.17	1.53	1.45
80	cl	10	2MG	C5-C6	3.04	1.53	1.47
80	cl	46	G7M	C2-N1	2.99	1.45	1.37
80	cl	26	2MG	C5-C6	2.91	1.53	1.47
80	cl	28	PSU	C6-C5	2.86	1.38	1.35
80	cl	9	1MG	C5-C4	-2.71	1.36	1.43

*Continued on next page...*

*Continued from previous page...*

Mol	Chain	Res	Type	Atoms	Z	Observed(Å)	Ideal(Å)
80	cl	26	2MG	C5-C4	-2.62	1.36	1.43
80	cl	10	2MG	C5-C4	-2.54	1.36	1.43
80	cl	49	5MC	O2-C2	-2.53	1.19	1.23
80	cl	58	1MA	C5-C4	-2.53	1.36	1.43
80	cl	48	5MC	O2-C2	-2.43	1.19	1.23
80	cl	47	H2U	O2-C2	-2.39	1.18	1.23
80	cl	46	G7M	O6-C6	-2.34	1.18	1.23
80	cl	28	PSU	C4-C5	-2.31	1.37	1.44
80	cl	9	1MG	O6-C6	-2.29	1.18	1.22
80	cl	47	H2U	O4-C4	-2.22	1.18	1.23
80	cl	46	G7M	C8-N7	2.16	1.37	1.33
80	cl	48	5MC	CM5-C5	2.15	1.56	1.50
80	cl	49	5MC	CM5-C5	2.14	1.56	1.50
80	cl	55	PSU	C4-C5	-2.00	1.38	1.44

All (42) bond angle outliers are listed below:

Mol	Chain	Res	Type	Atoms	Z	Observed(°)	Ideal(°)
80	cl	37	MIA	C1'-N9-C4	12.91	149.32	126.64
80	cl	37	MIA	C11-S10-C2	7.19	107.64	102.27
80	cl	47	H2U	C4-N3-C2	-6.92	120.05	125.79
80	cl	28	PSU	C4-N3-C2	-4.69	119.58	126.34
80	cl	37	MIA	C12-N6-C6	-4.61	115.72	122.55
80	cl	55	PSU	C4-N3-C2	-4.54	119.80	126.34
80	cl	28	PSU	N1-C2-N3	4.53	120.27	115.13
80	cl	58	1MA	N1-C2-N3	-4.45	120.83	126.02
80	cl	9	1MG	C5-C6-N1	4.25	120.28	113.90
80	cl	55	PSU	N1-C2-N3	4.22	119.91	115.13
80	cl	58	1MA	C5-C6-N1	4.20	120.16	113.90
80	cl	48	5MC	C5-C6-N1	-3.80	119.43	123.34
80	cl	37	MIA	N3-C2-N1	-3.48	120.58	126.98
80	cl	10	2MG	C5-C6-N1	3.41	119.97	113.95
80	cl	49	5MC	C1'-N1-C6	-3.36	115.53	121.12
80	cl	37	MIA	C2-N3-C4	3.34	119.93	115.32
80	cl	49	5MC	C1'-N1-C2	3.21	125.57	118.42
80	cl	26	2MG	C5-C6-N1	3.11	119.45	113.95
80	cl	47	H2U	N3-C2-N1	3.10	119.93	116.65
80	cl	47	H2U	C5-C4-N3	3.04	120.06	116.65
80	cl	46	G7M	C2-N1-C6	-2.94	119.67	125.10
80	cl	28	PSU	O2-C2-N1	-2.92	119.58	122.79
80	cl	10	2MG	O6-C6-C5	-2.80	118.89	124.37
80	cl	10	2MG	C8-N7-C5	2.78	108.30	102.99

*Continued on next page...*

*Continued from previous page...*

Mol	Chain	Res	Type	Atoms	Z	Observed(°)	Ideal(°)
80	cl	58	1MA	C8-N7-C5	2.71	108.16	102.99
80	cl	37	MIA	S10-C2-N3	2.69	125.43	116.10
80	cl	9	1MG	C8-N7-C5	2.62	107.98	102.99
80	cl	47	H2U	C5-C6-N1	2.59	120.16	111.61
80	cl	55	PSU	O2-C2-N1	-2.59	119.94	122.79
80	cl	26	2MG	C8-N7-C5	2.55	107.84	102.99
80	cl	26	2MG	O6-C6-C5	-2.50	119.49	124.37
80	cl	49	5MC	O2-C2-N3	-2.48	118.30	122.33
80	cl	28	PSU	C6-N1-C2	-2.38	120.25	122.68
80	cl	47	H2U	O2-C2-N1	-2.33	120.19	123.11
80	cl	9	1MG	O6-C6-C5	-2.21	120.27	124.19
80	cl	48	5MC	C5-C4-N4	-2.19	118.20	121.48
80	cl	26	2MG	CM2-N2-C2	-2.18	119.05	123.86
80	cl	55	PSU	C6-N1-C2	-2.14	120.50	122.68
80	cl	46	G7M	N2-C2-N1	2.12	121.22	116.71
80	cl	49	5MC	C5-C6-N1	-2.10	121.18	123.34
80	cl	37	MIA	C4-C5-N7	-2.01	107.31	109.40
80	cl	9	1MG	C2-N1-C6	-2.01	119.31	120.95

There are no chirality outliers.

All (25) torsion outliers are listed below:

Mol	Chain	Res	Type	Atoms
80	cl	10	2MG	O4'-C4'-C5'-O5'
80	cl	37	MIA	O4'-C4'-C5'-O5'
80	cl	37	MIA	C3'-C4'-C5'-O5'
80	cl	46	G7M	O4'-C4'-C5'-O5'
80	cl	46	G7M	C3'-C4'-C5'-O5'
80	cl	49	5MC	O4'-C4'-C5'-O5'
80	cl	49	5MC	C3'-C4'-C5'-O5'
80	cl	55	PSU	C2'-C1'-C5-C6
80	cl	55	PSU	O4'-C1'-C5-C6
80	cl	10	2MG	C3'-C4'-C5'-O5'
80	cl	26	2MG	O4'-C4'-C5'-O5'
80	cl	26	2MG	C3'-C4'-C5'-O5'
80	cl	47	H2U	O4'-C4'-C5'-O5'
80	cl	47	H2U	C3'-C4'-C5'-O5'
80	cl	58	1MA	O4'-C4'-C5'-O5'
80	cl	58	1MA	C3'-C4'-C5'-O5'
80	cl	46	G7M	C4'-C5'-O5'-P
80	cl	47	H2U	C4'-C5'-O5'-P
80	cl	37	MIA	C5-C6-N6-C12

*Continued on next page...*



Continued from previous page...

Mol	Chain	Res	Type	Atoms
80	cl	37	MIA	N1-C6-N6-C12
80	cl	48	5MC	C4'-C5'-O5'-P
80	cl	49	5MC	C2'-C1'-N1-C2
80	cl	49	5MC	C2'-C1'-N1-C6
80	cl	55	PSU	C3'-C4'-C5'-O5'
80	cl	55	PSU	O4'-C4'-C5'-O5'

There are no ring outliers.

No monomer is involved in short contacts.

## 5.5 Carbohydrates [i](#)

There are no monosaccharides in this entry.

## 5.6 Ligand geometry [i](#)

Of 289 ligands modelled in this entry, 288 are monoatomic - leaving 1 for Mogul analysis.

In the following table, the Counts columns list the number of bonds (or angles) for which Mogul statistics could be retrieved, the number of bonds (or angles) that are observed in the model and the number of bonds (or angles) that are defined in the Chemical Component Dictionary. The Link column lists molecule types, if any, to which the group is linked. The Z score for a bond length (or angle) is the number of standard deviations the observed value is removed from the expected value. A bond length (or angle) with  $|Z| > 2$  is considered an outlier worth inspection. RMSZ is the root-mean-square of all Z scores of the bond lengths (or angles).

Mol	Type	Chain	Res	Link	Bond lengths			Bond angles		
					Counts	RMSZ	# Z  > 2	Counts	RMSZ	# Z  > 2
83	3HE	RB	5197	-	21,21,21	1.50	4 (19%)	19,30,30	2.66	10 (52%)

In the following table, the Chirals column lists the number of chiral outliers, the number of chiral centers analysed, the number of these observed in the model and the number defined in the Chemical Component Dictionary. Similar counts are reported in the Torsion and Rings columns. '-' means no outliers of that kind were identified.

Mol	Type	Chain	Res	Link	Chirals	Torsions	Rings
83	3HE	RB	5197	-	-	3/8/36/36	0/2/2/2

All (4) bond length outliers are listed below:

Mol	Chain	Res	Type	Atoms	Z	Observed(Å)	Ideal(Å)
83	RB	5197	3HE	C8-C9	-3.16	1.48	1.53
83	RB	5197	3HE	O1-C11	-2.80	1.17	1.23
83	RB	5197	3HE	O2-C12	-2.61	1.18	1.23
83	RB	5197	3HE	O-C4	-2.26	1.17	1.21

All (10) bond angle outliers are listed below:

Mol	Chain	Res	Type	Atoms	Z	Observed(°)	Ideal(°)
83	RB	5197	3HE	C11-N-C12	-5.76	118.79	125.78
83	RB	5197	3HE	C13-C12-N	-4.44	110.51	115.95
83	RB	5197	3HE	C14-C3-C4	-4.09	108.23	112.53
83	RB	5197	3HE	C9-C8-C7	-3.58	107.99	116.82
83	RB	5197	3HE	C10-C11-N	-3.17	112.06	115.95
83	RB	5197	3HE	C6-C5-C4	2.79	112.27	108.13
83	RB	5197	3HE	C6-C1-C2	2.65	114.00	110.10
83	RB	5197	3HE	C-C1-C2	-2.37	107.15	111.18
83	RB	5197	3HE	O2-C12-N	2.22	123.79	120.28
83	RB	5197	3HE	O1-C11-N	2.08	123.58	120.28

There are no chirality outliers.

All (3) torsion outliers are listed below:

Mol	Chain	Res	Type	Atoms
83	RB	5197	3HE	C6-C5-C7-C8
83	RB	5197	3HE	C4-C5-C7-O3
83	RB	5197	3HE	C6-C5-C7-O3

There are no ring outliers.

No monomer is involved in short contacts.

The following is a two-dimensional graphical depiction of Mogul quality analysis of bond lengths, bond angles, torsion angles, and ring geometry for all instances of the Ligand of Interest. In addition, ligands with molecular weight > 250 and outliers as shown on the validation Tables will also be included. For torsion angles, if less than 5% of the Mogul distribution of torsion angles is within 10 degrees of the torsion angle in question, then that torsion angle is considered an outlier. Any bond that is central to one or more torsion angles identified as an outlier by Mogul will be highlighted in the graph. For rings, the root-mean-square deviation (RMSD) between the ring in question and similar rings identified by Mogul is calculated over all ring torsion angles. If the average RMSD is greater than 60 degrees and the minimal RMSD between the ring in question and any Mogul-identified rings is also greater than 60 degrees, then that ring is considered an outlier. The outliers are highlighted in purple. The color gray indicates Mogul did not find sufficient equivalents in the CSD to analyse the geometry.

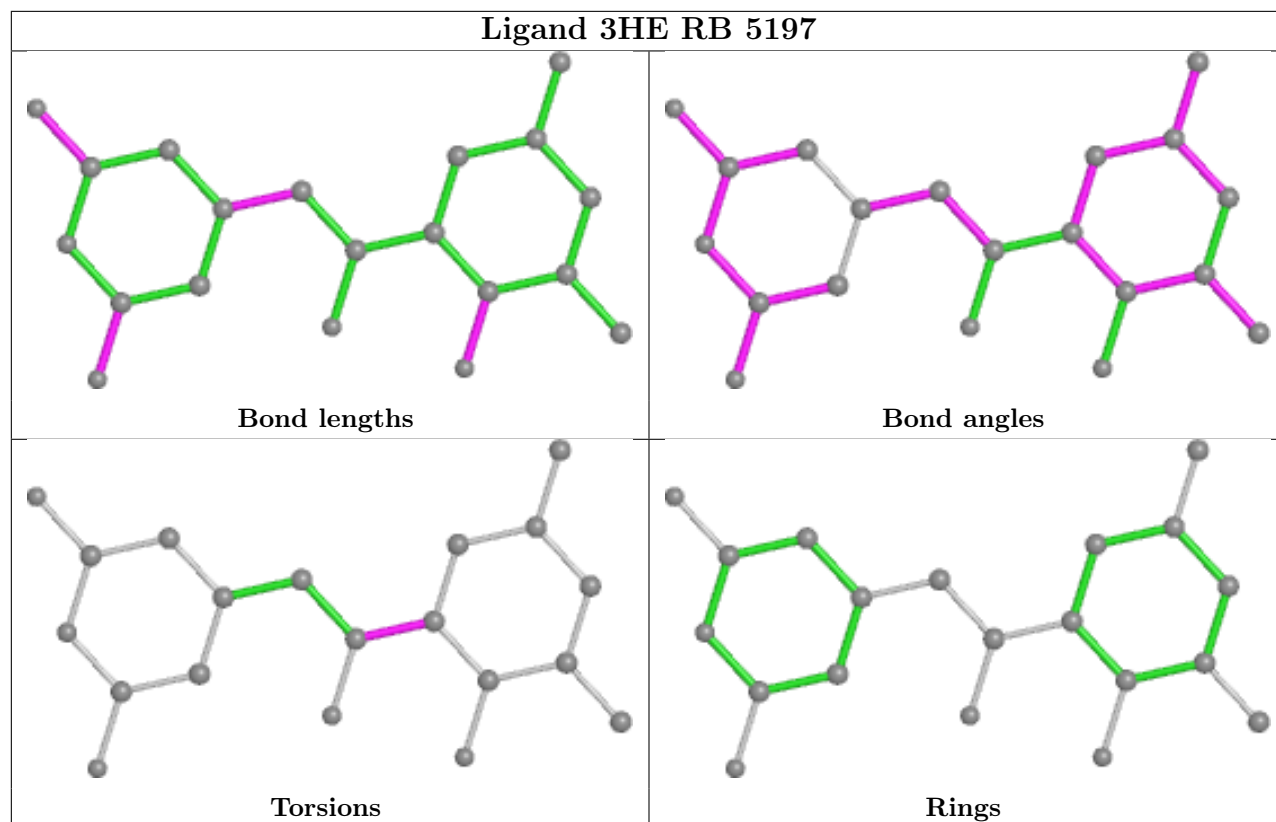

## 5.7 Other polymers [i](#)

There are no such residues in this entry.

## 5.8 Polymer linkage issues [i](#)

There are no chain breaks in this entry.

## 6 Map visualisation [i](#)

This section contains visualisations of the EMDB entry EMD-35637. These allow visual inspection of the internal detail of the map and identification of artifacts.

Images derived from a raw map, generated by summing the deposited half-maps, are presented below the corresponding image components of the primary map to allow further visual inspection and comparison with those of the primary map.

### 6.1 Orthogonal projections [i](#)

#### 6.1.1 Primary map

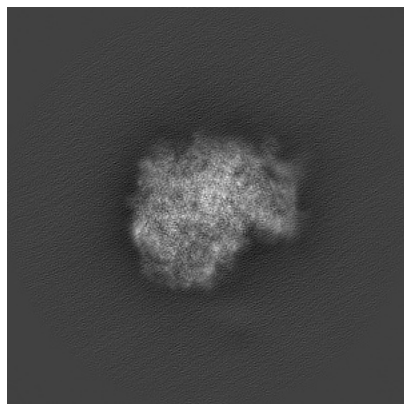

X

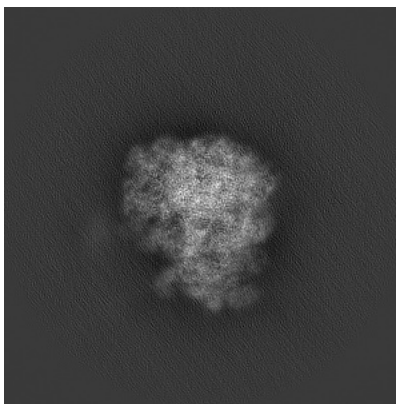

Y

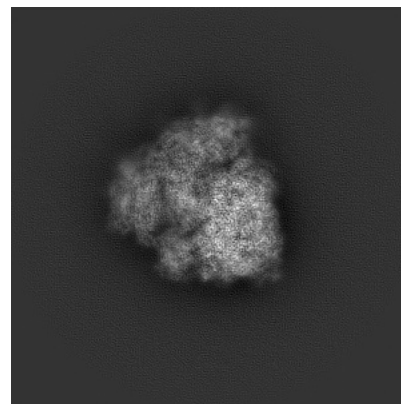

Z

#### 6.1.2 Raw map

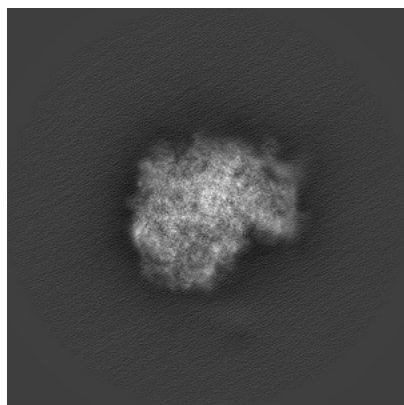

X

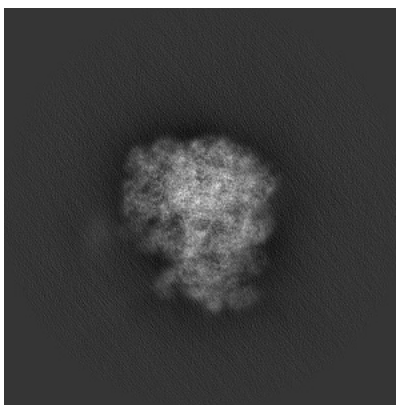

Y

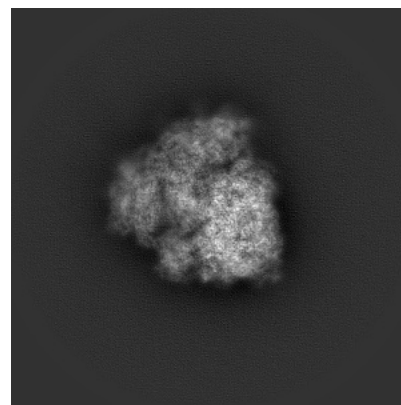

Z

The images above show the map projected in three orthogonal directions.

## 6.2 Central slices [i](#)

### 6.2.1 Primary map

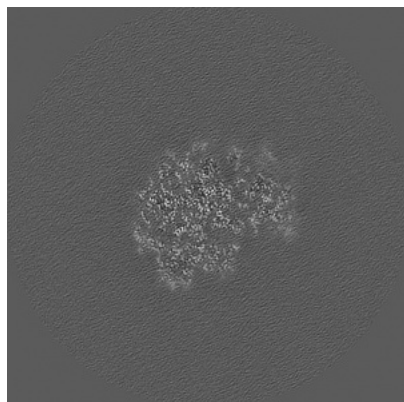

X Index: 200

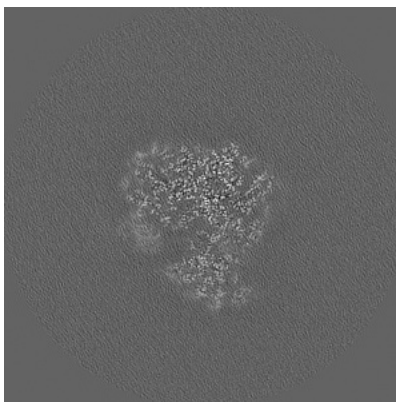

Y Index: 200

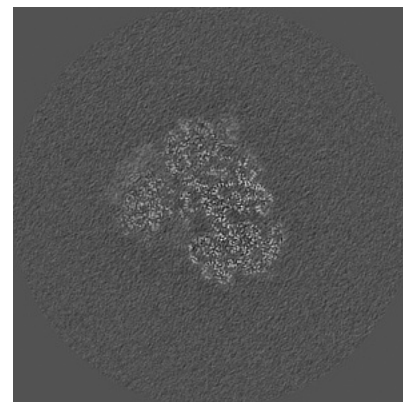

Z Index: 200

### 6.2.2 Raw map

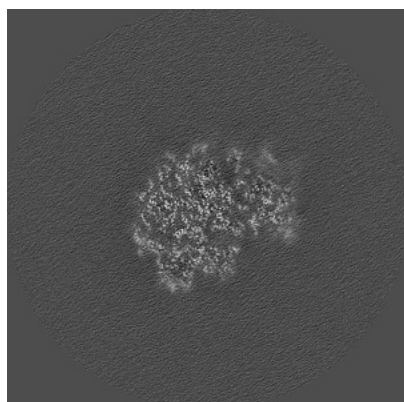

X Index: 200

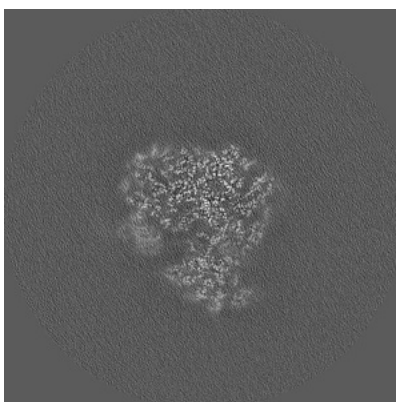

Y Index: 200

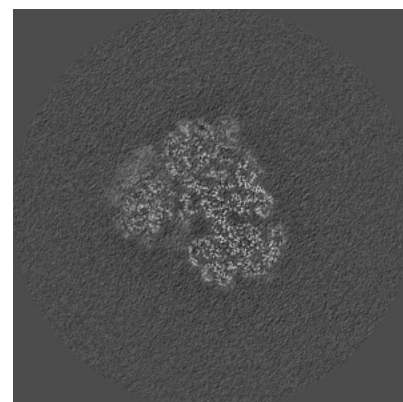

Z Index: 200

The images above show central slices of the map in three orthogonal directions.



## 6.3 Largest variance slices [i](#)

### 6.3.1 Primary map

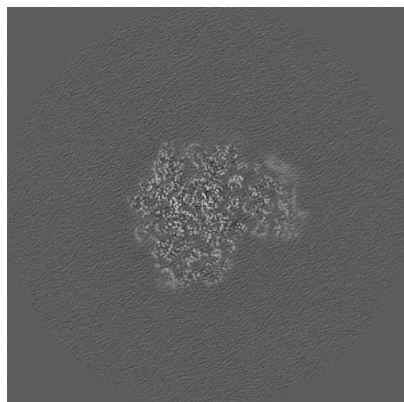

X Index: 209

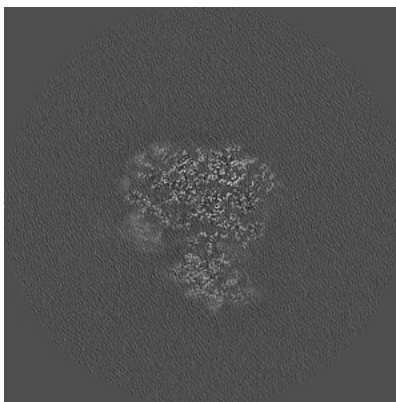

Y Index: 202

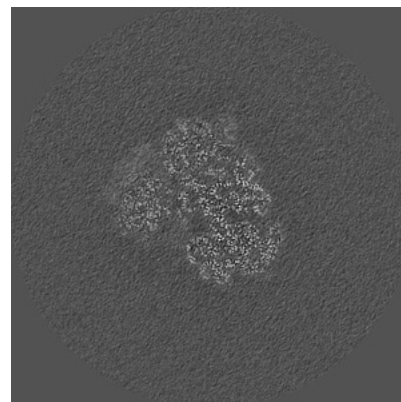

Z Index: 200

### 6.3.2 Raw map

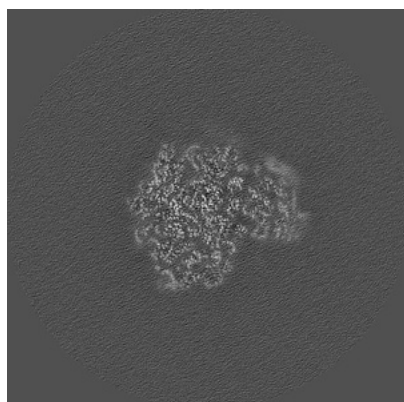

X Index: 209

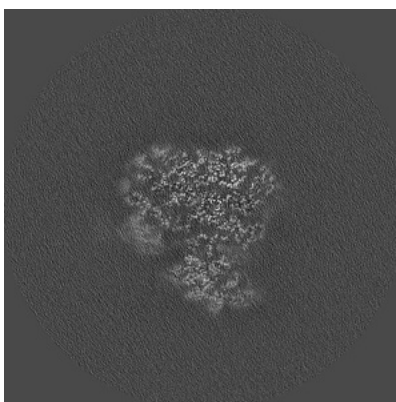

Y Index: 202

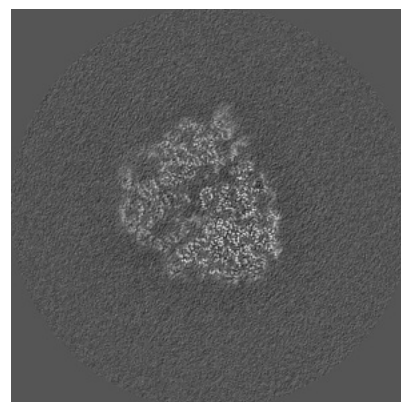

Z Index: 191

The images above show the largest variance slices of the map in three orthogonal directions.

## 6.4 Orthogonal standard-deviation projections (False-color) [i](#)

### 6.4.1 Primary map

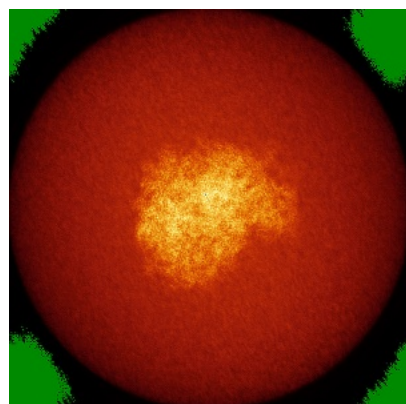

X

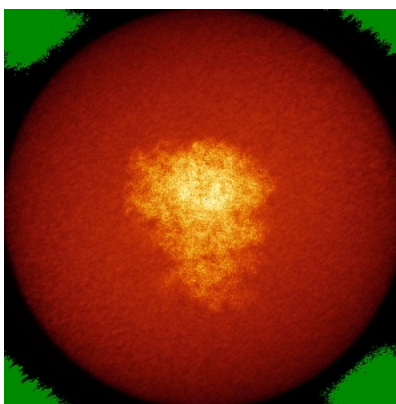

Y

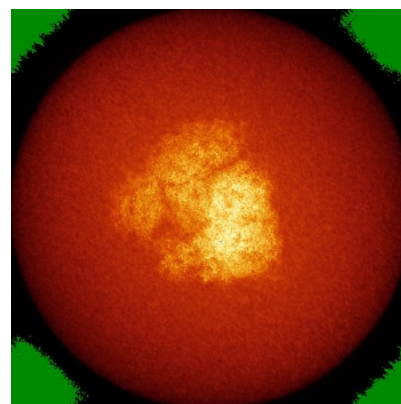

Z

### 6.4.2 Raw map

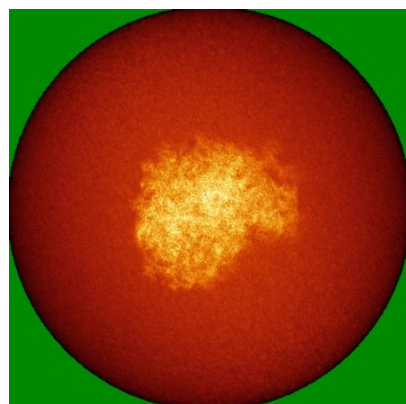

X

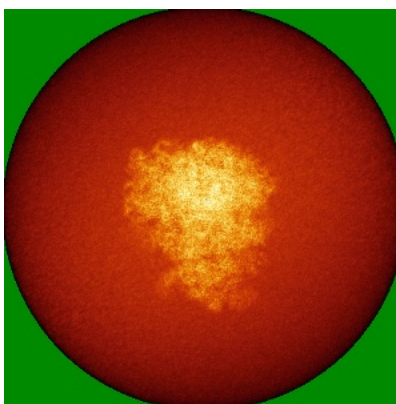

Y

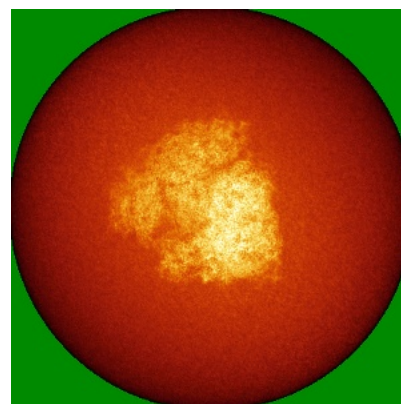

Z

The images above show the map standard deviation projections with false color in three orthogonal directions. Minimum values are shown in green, max in blue, and dark to light orange shades represent small to large values respectively.

## 6.5 Orthogonal surface views [i](#)

### 6.5.1 Primary map

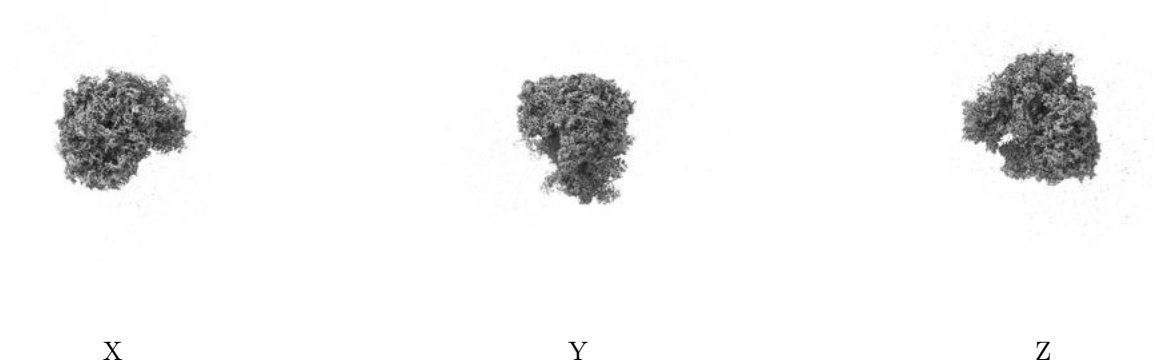

The images above show the 3D surface view of the map at the recommended contour level 0.04. These images, in conjunction with the slice images, may facilitate assessment of whether an appropriate contour level has been provided.

### 6.5.2 Raw map

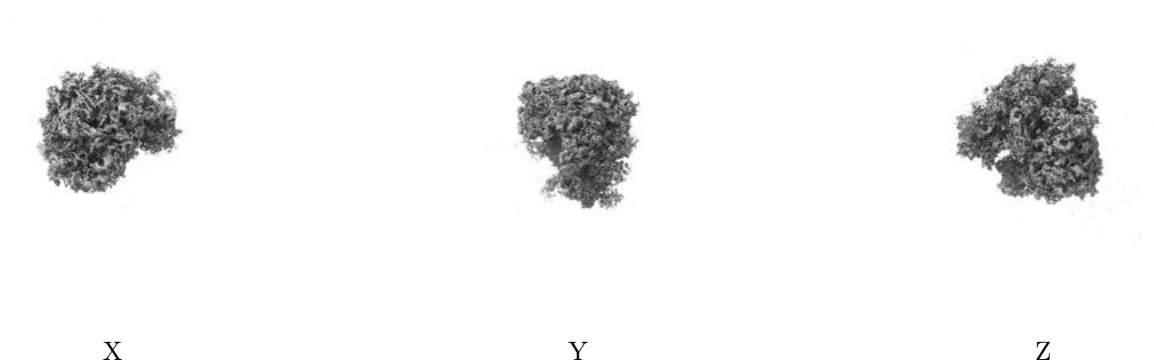

These images show the 3D surface of the raw map. The raw map's contour level was selected so that its surface encloses the same volume as the primary map does at its recommended contour level.

## 6.6 Mask visualisation [i](#)

This section was not generated. No masks/segmentation were deposited.



## 7 Map analysis [i](#)

This section contains the results of statistical analysis of the map.

### 7.1 Map-value distribution [i](#)

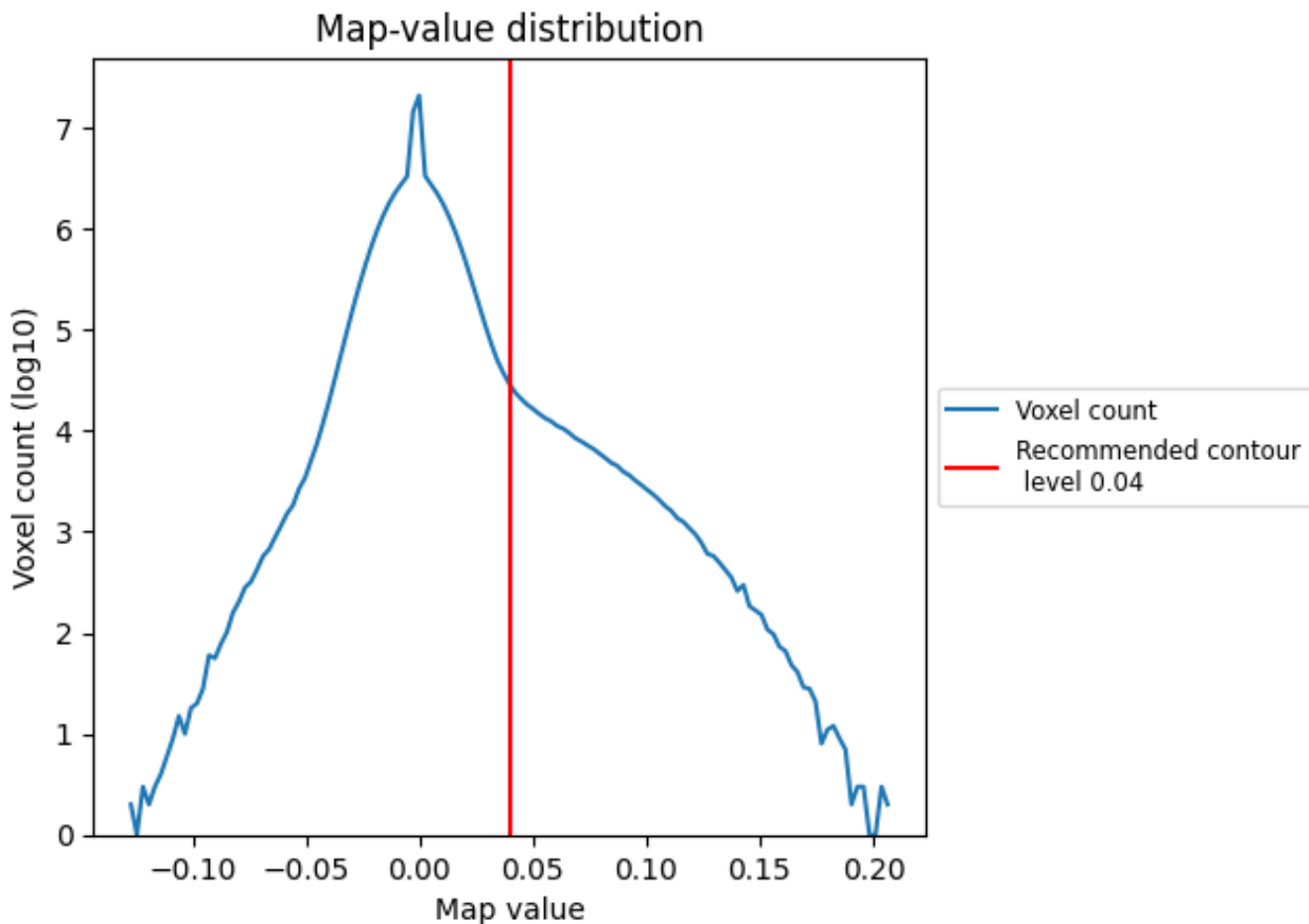

The map-value distribution is plotted in 128 intervals along the x-axis. The y-axis is logarithmic. A spike in this graph at zero usually indicates that the volume has been masked.

## 7.2 Volume estimate [i](#)

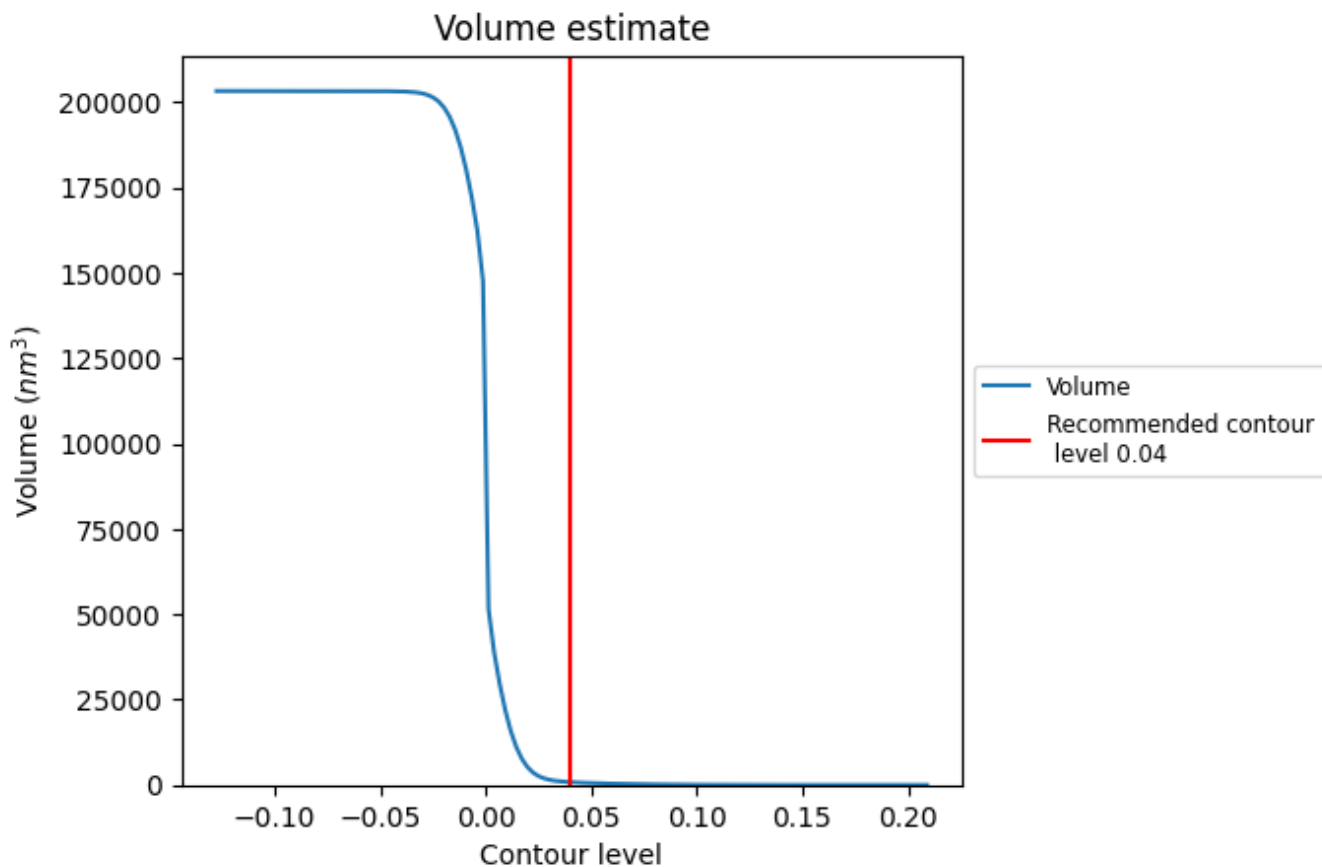

The volume at the recommended contour level is  $824 \text{ nm}^3$ ; this corresponds to an approximate mass of 745 kDa.

The volume estimate graph shows how the enclosed volume varies with the contour level. The recommended contour level is shown as a vertical line and the intersection between the line and the curve gives the volume of the enclosed surface at the given level.

### 7.3 Rotationally averaged power spectrum [i](#)

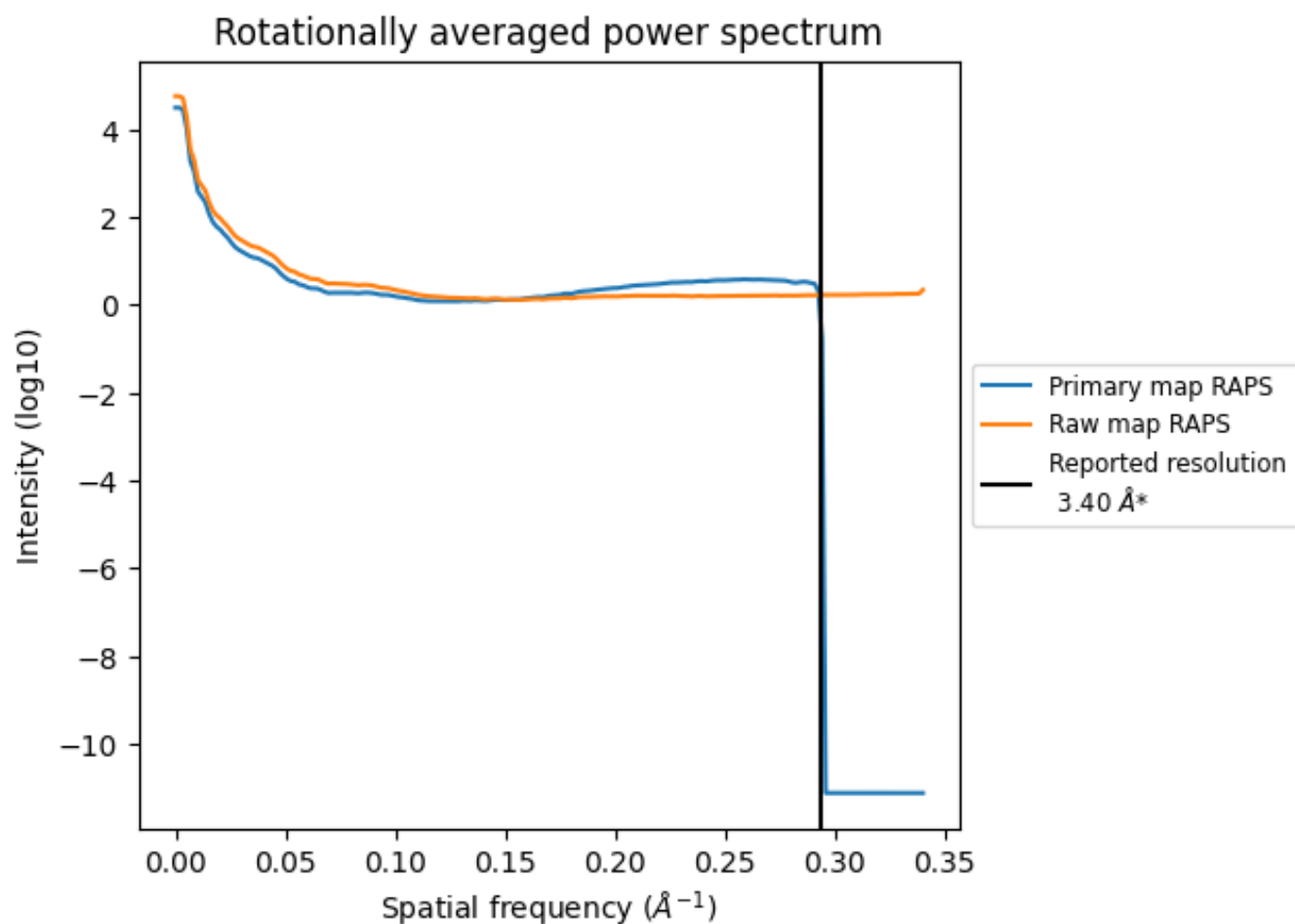

\*Reported resolution corresponds to spatial frequency of 0.294 Å<sup>-1</sup>

## 8 Fourier-Shell correlation [i](#)

Fourier-Shell Correlation (FSC) is the most commonly used method to estimate the resolution of single-particle and subtomogram-averaged maps. The shape of the curve depends on the imposed symmetry, mask and whether or not the two 3D reconstructions used were processed from a common reference. The reported resolution is shown as a black line. A curve is displayed for the half-bit criterion in addition to lines showing the 0.143 gold standard cut-off and 0.5 cut-off.

### 8.1 FSC [i](#)

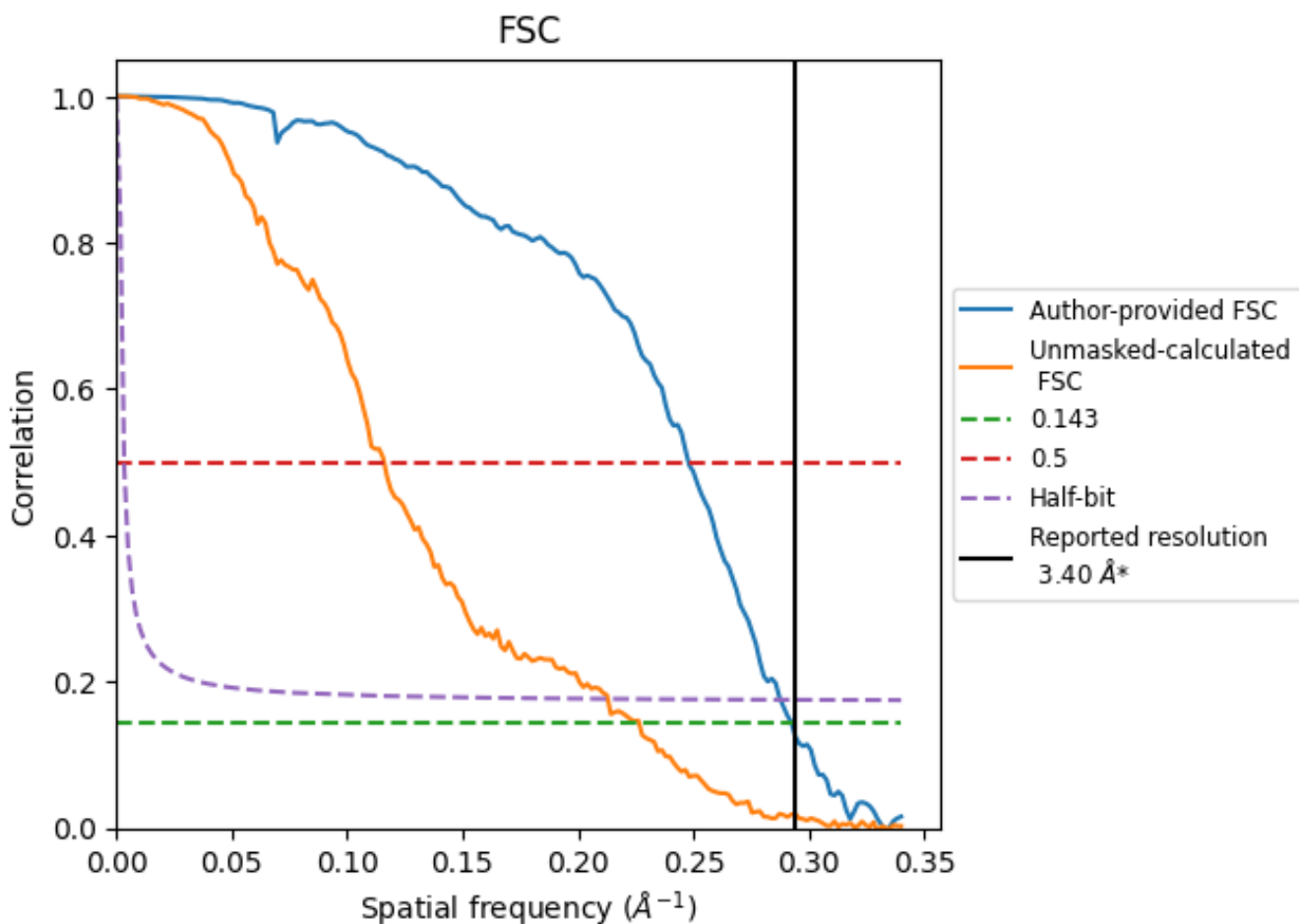

\*Reported resolution corresponds to spatial frequency of 0.294 Å<sup>-1</sup>

## 8.2 Resolution estimates [i](#)

Resolution estimate (Å)	Estimation criterion (FSC cut-off)		
	0.143	0.5	Half-bit
Reported by author	3.40	-	-
Author-provided FSC curve	3.42	4.03	3.47
Unmasked-calculated*	4.42	8.62	4.70

\*Resolution estimate based on FSC curve calculated by comparison of deposited half-maps. The value from deposited half-maps intersecting FSC 0.143 CUT-OFF 4.42 differs from the reported value 3.4 by more than 10 %

## 9 Map-model fit [i](#)

This section contains information regarding the fit between EMDB map EMD-35637 and PDB model 8IPA. Per-residue inclusion information can be found in section [3](#) on page [20](#).

### 9.1 Map-model overlay [i](#)

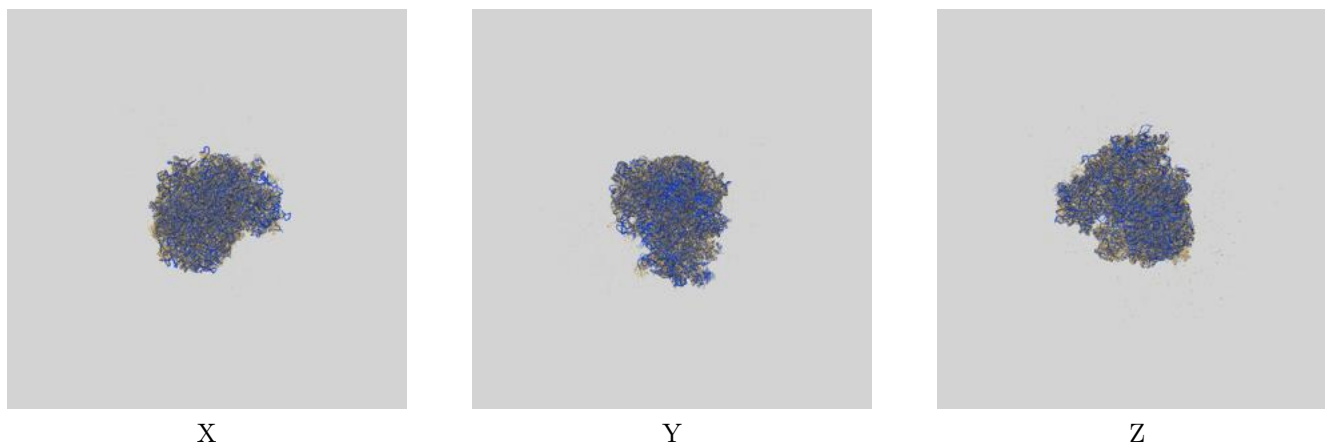

The images above show the 3D surface view of the map at the recommended contour level 0.04 at 50% transparency in yellow overlaid with a ribbon representation of the model coloured in blue. These images allow for the visual assessment of the quality of fit between the atomic model and the map.

## 9.2 Q-score mapped to coordinate model [i](#)

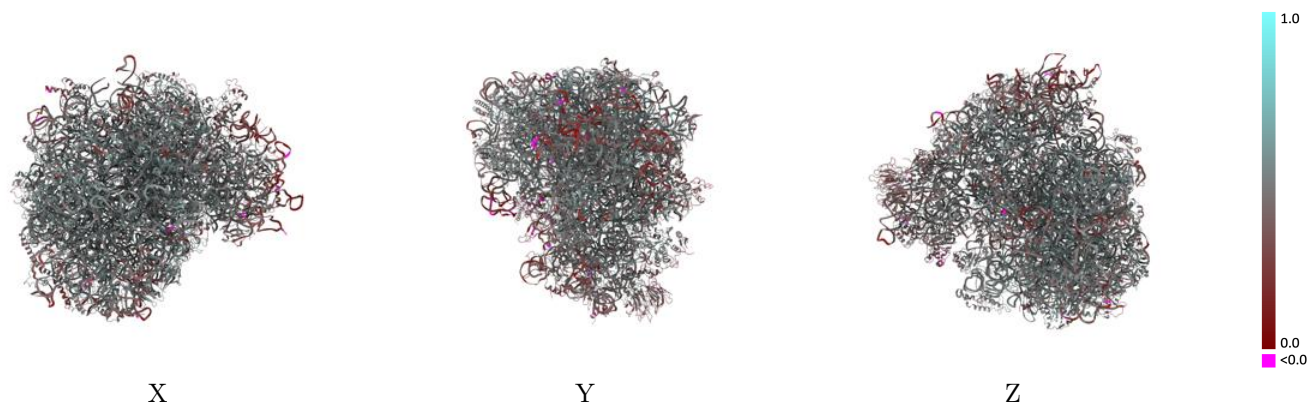

The images above show the model with each residue coloured according to its Q-score. This shows their resolvability in the map with higher Q-score values reflecting better resolvability. Please note: Q-score is calculating the resolvability of atoms, and thus high values are only expected at resolutions at which atoms can be resolved. Low Q-score values may therefore be expected for many entries.

## 9.3 Atom inclusion mapped to coordinate model [i](#)

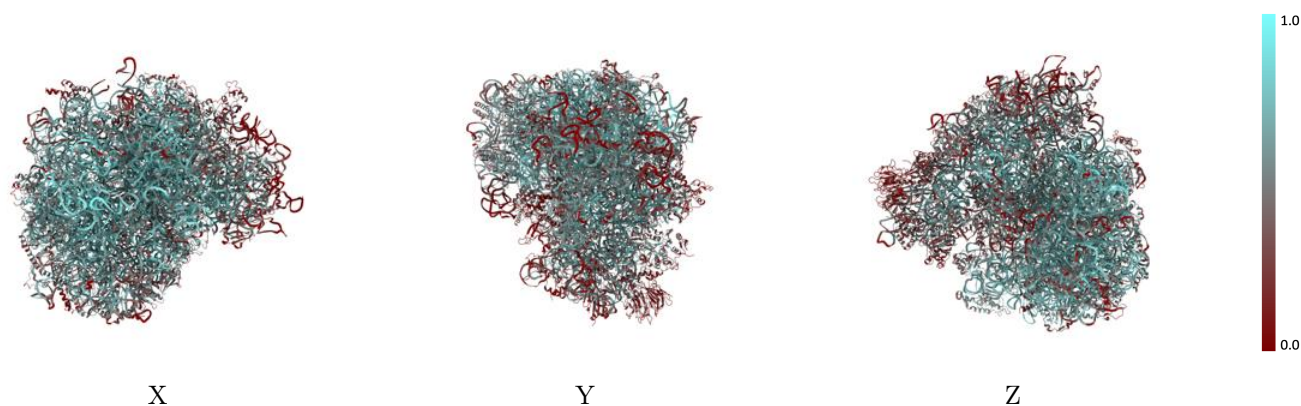

The images above show the model with each residue coloured according to its atom inclusion. This shows to what extent they are inside the map at the recommended contour level (0.04).

## 9.4 Atom inclusion [i](#)

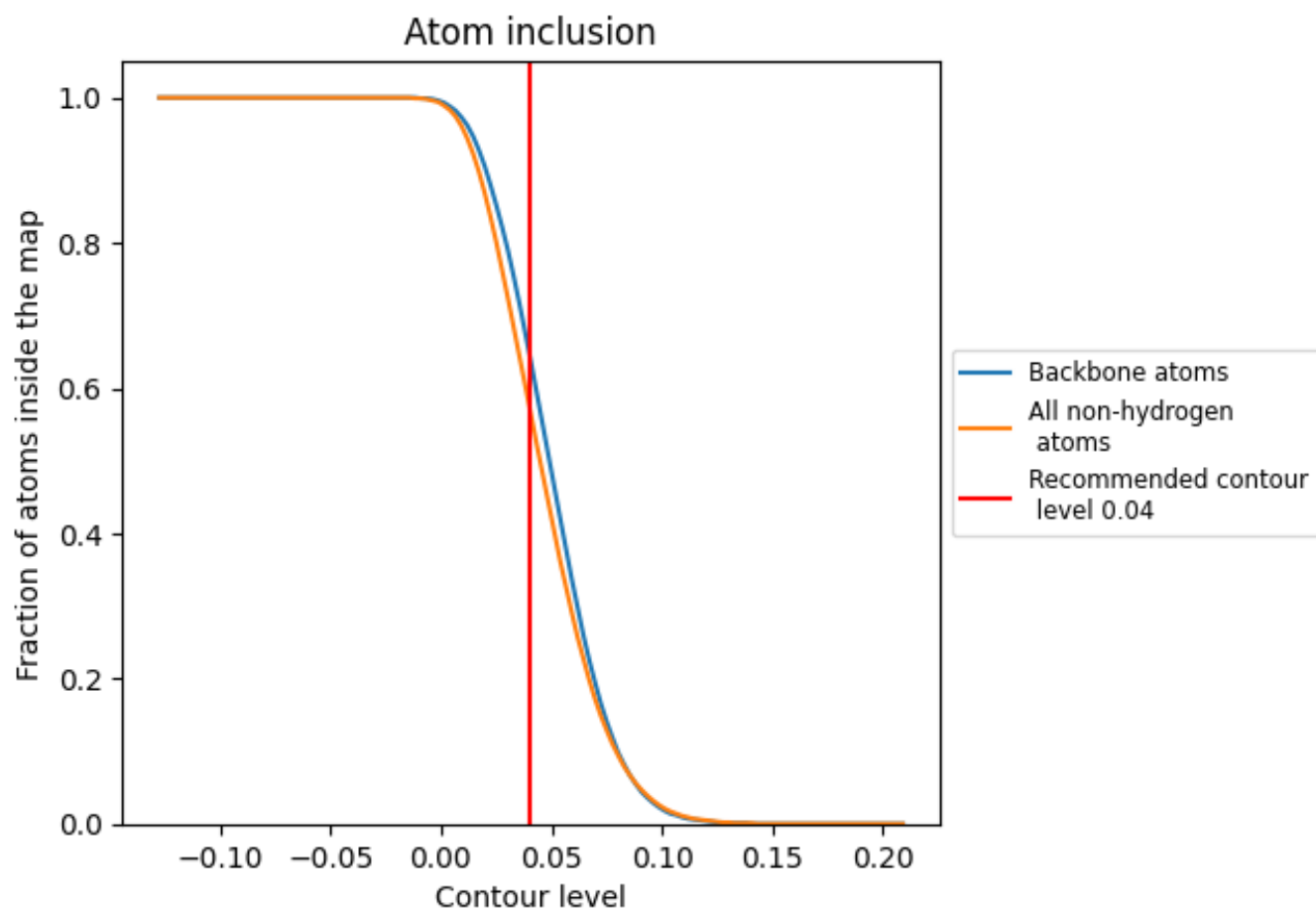







































































At the recommended contour level, 65% of all backbone atoms, 57% of all non-hydrogen atoms, are inside the map.



## 9.5 Map-model fit summary





















































































The table lists the average atom inclusion at the recommended contour level (0.04) and Q-score for the entire model and for each chain.

Chain	Atom inclusion	Q-score
All	 0.5750	 0.4710
AA	 0.4140	 0.4570
AB	 0.5010	 0.4880
BA	 0.5640	 0.5190
BB	 0.5040	 0.4720
CA	 0.5090	 0.4840
CB	 0.5660	 0.5000
DA	 0.6490	 0.5440
DB	 0.5990	 0.5180
EA	 0.4550	 0.4590
EB	 0.5390	 0.4930
FA	 0.4530	 0.4830
FB	 0.5480	 0.5030
GA	 0.5680	 0.5150
GB	 0.5680	 0.5250
HA	 0.6800	 0.5300
HB	 0.4220	 0.4860
IA	 0.6470	 0.5290
IB	 0.5830	 0.4960
JA	 0.5980	 0.5160
JB	 0.5570	 0.5120
KA	 0.5350	 0.4790
KB	 0.5510	 0.4960
LA	 0.5710	 0.5050
LB	 0.4120	 0.4390
MA	 0.5980	 0.5220
MB	 0.6180	 0.5270
NA	 0.5540	 0.5030
NB	 0.4310	 0.4510
OA	 0.5810	 0.5080
OB	 0.5980	 0.5100
PA	 0.6070	 0.5070
PB	 0.6290	 0.5240
QA	 0.5400	 0.5040
RA	 0.5410	 0.4870



*Continued on next page...*

*Continued from previous page...*

Chain	Atom inclusion	Q-score
RB	 0.7020	 0.4810
SA	 0.5680	 0.4990
SB	 0.6960	 0.4770
TA	 0.6190	 0.5300
TB	 0.7440	 0.4940
UA	 0.6900	 0.5310
VA	 0.6350	 0.5170
WA	 0.5640	 0.5200
XA	 0.4960	 0.4820
YA	 0.5740	 0.5160
ZA	 0.3300	 0.4190
aa	 0.5870	 0.4460
al	 0.6730	 0.5060
ba	 0.3190	 0.4460
bb	 0.3790	 0.4540
bl	 0.1900	 0.3730
ca	 0.4630	 0.4950
cb	 0.4390	 0.4580
cl	 0.3390	 0.3980
da	 0.1980	 0.3420
db	 0.5200	 0.4980
eb	 0.4460	 0.4650
fb	 0.4980	 0.4930
ga	 0.4970	 0.5080
gb	 0.2340	 0.3960
ha	 0.1510	 0.3490
hb	 0.3010	 0.4100
ia	 0.3040	 0.4340
ib	 0.4910	 0.5040
ja	 0.4350	 0.4710
ka	 0.3310	 0.4340
la	 0.3670	 0.4560
ma	 0.3150	 0.4050
na	 0.4320	 0.4840
oa	 0.3340	 0.4350
pa	 0.4750	 0.4980
qa	 0.2310	 0.3970
ra	 0.4080	 0.4530
sa	 0.2800	 0.4180
ta	 0.1740	 0.2500
ua	 0.3040	 0.4330
va	 0.5170	 0.4760

*Continued on next page...*

*Continued from previous page...*

Chain	Atom inclusion	Q-score
wa	█ 0.5120	█ 0.4890
xa	█ 0.4050	█ 0.4720
ya	█ 0.4140	█ 0.4730
za	█ 0.4070	█ 0.4610