



Full wwPDB EM Validation Report ⓘ

Nov 20, 2022 – 10:20 am GMT

PDB ID : 6HZ7
EMDB ID : EMD-0313
Title : Structure of McrBC without DNA binding domains (Class 3)
Authors : Itoh, Y.; Nirwan, N.; Saikrishnan, K.; Amunts, A.
Deposited on : 2018-10-22
Resolution : 4.30 Å (reported)

This is a Full wwPDB EM Validation Report for a publicly released PDB entry.

We welcome your comments at validation@mail.wwpdb.org

A user guide is available at

<https://www.wwpdb.org/validation/2017/EMValidationReportHelp>

with specific help available everywhere you see the ⓘ symbol.

The types of validation reports are described at

<http://www.wwpdb.org/validation/2017/FAQs#types>.

The following versions of software and data (see [references ⓘ](#)) were used in the production of this report:

EMDB validation analysis : 0.0.1.dev43
Mogul : 1.8.4, CSD as541be (2020)
MolProbity : 4.02b-467
buster-report : 1.1.7 (2018)
Percentile statistics : 20191225.v01 (using entries in the PDB archive December 25th 2019)
MapQ : 1.9.9
Ideal geometry (proteins) : Engh & Huber (2001)
Ideal geometry (DNA, RNA) : Parkinson et al. (1996)
Validation Pipeline (wwPDB-VP) : 2.31.2

1 Overall quality at a glance

The following experimental techniques were used to determine the structure:
ELECTRON MICROSCOPY

The reported resolution of this entry is 4.30 Å.

Percentile scores (ranging between 0-100) for global validation metrics of the entry are shown in the following graphic. The table shows the number of entries on which the scores are based.

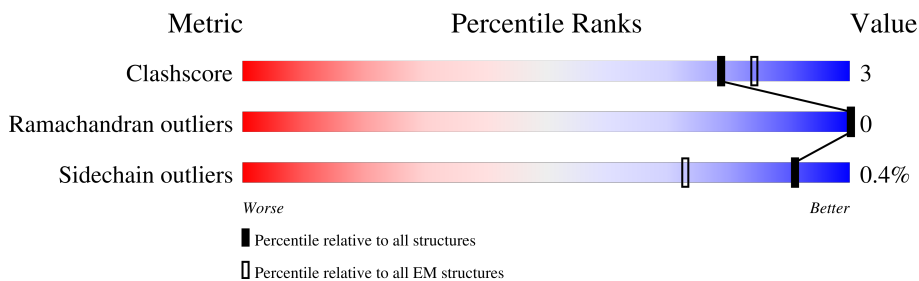

Metric	Whole archive (#Entries)	EM structures (#Entries)
Clashscore	158937	4297
Ramachandran outliers	154571	4023
Sidechain outliers	154315	3826

The table below summarises the geometric issues observed across the polymeric chains and their fit to the map. The red, orange, yellow and green segments of the bar indicate the fraction of residues that contain outliers for ≥ 3 , 2, 1 and 0 types of geometric quality criteria respectively. A grey segment represents the fraction of residues that are not modelled. The numeric value for each fraction is indicated below the corresponding segment, with a dot representing fractions $\leq 5\%$. The upper red bar (where present) indicates the fraction of residues that have poor fit to the EM map (all-atom inclusion $< 40\%$). The numeric value is given above the bar.

Mol	Chain	Length	Quality of chain
1	A	307	
1	B	307	
1	C	307	
1	D	307	
1	E	307	
1	F	307	
1	G	307	
1	H	307	

Continued on next page...

Continued from previous page...

Mol	Chain	Length	Quality of chain
1	I	307	<p>26% 91% 6%</p>
1	J	307	<p>26% 84% 8% 7%</p>
1	K	307	<p>40% 83% 10% 7%</p>
1	L	307	<p>49% 85% 8% 7%</p>
2	M	348	<p>22% 90% 7% 7%</p>
2	N	348	<p>22% 89% 7% 7%</p>

2 Entry composition i

There are 5 unique types of molecules in this entry. The entry contains 67732 atoms, of which 33518 are hydrogens and 0 are deuteriums.

In the tables below, the AltConf column contains the number of residues with at least one atom in alternate conformation and the Trace column contains the number of residues modelled with at most 2 atoms.

- Molecule 1 is a protein called 5-methylcytosine-specific restriction enzyme B.

Mol	Chain	Residues	Atoms					AltConf	Trace	
			Total	C	H	N	O			S
1	A	290	4720	1530	2338	397	443	12	0	0
1	B	290	4719	1530	2337	397	443	12	0	0
1	C	290	4717	1530	2335	397	443	12	0	0
1	D	284	4633	1500	2299	391	432	11	0	0
1	E	285	4637	1503	2298	392	433	11	0	0
1	F	285	4644	1503	2305	392	433	11	0	0
1	G	290	4720	1530	2338	397	443	12	0	0
1	H	290	4719	1530	2337	397	443	12	0	0
1	I	290	4717	1530	2335	397	443	12	0	0
1	J	284	4633	1500	2299	391	432	11	0	0
1	K	285	4637	1503	2298	392	433	11	0	0
1	L	285	4644	1503	2305	392	433	11	0	0

There are 108 discrepancies between the modelled and reference sequences:

Chain	Residue	Modelled	Actual	Comment	Reference
A	460	SER	-	expression tag	UNP P15005
A	461	GLY	-	expression tag	UNP P15005
A	462	SER	-	expression tag	UNP P15005
A	463	HIS	-	expression tag	UNP P15005
A	464	HIS	-	expression tag	UNP P15005
A	465	HIS	-	expression tag	UNP P15005

Continued on next page...

Continued from previous page...

Chain	Residue	Modelled	Actual	Comment	Reference
A	466	HIS	-	expression tag	UNP P15005
A	467	HIS	-	expression tag	UNP P15005
A	468	HIS	-	expression tag	UNP P15005
B	460	SER	-	expression tag	UNP P15005
B	461	GLY	-	expression tag	UNP P15005
B	462	SER	-	expression tag	UNP P15005
B	463	HIS	-	expression tag	UNP P15005
B	464	HIS	-	expression tag	UNP P15005
B	465	HIS	-	expression tag	UNP P15005
B	466	HIS	-	expression tag	UNP P15005
B	467	HIS	-	expression tag	UNP P15005
B	468	HIS	-	expression tag	UNP P15005
C	460	SER	-	expression tag	UNP P15005
C	461	GLY	-	expression tag	UNP P15005
C	462	SER	-	expression tag	UNP P15005
C	463	HIS	-	expression tag	UNP P15005
C	464	HIS	-	expression tag	UNP P15005
C	465	HIS	-	expression tag	UNP P15005
C	466	HIS	-	expression tag	UNP P15005
C	467	HIS	-	expression tag	UNP P15005
C	468	HIS	-	expression tag	UNP P15005
D	460	SER	-	expression tag	UNP P15005
D	461	GLY	-	expression tag	UNP P15005
D	462	SER	-	expression tag	UNP P15005
D	463	HIS	-	expression tag	UNP P15005
D	464	HIS	-	expression tag	UNP P15005
D	465	HIS	-	expression tag	UNP P15005
D	466	HIS	-	expression tag	UNP P15005
D	467	HIS	-	expression tag	UNP P15005
D	468	HIS	-	expression tag	UNP P15005
E	460	SER	-	expression tag	UNP P15005
E	461	GLY	-	expression tag	UNP P15005
E	462	SER	-	expression tag	UNP P15005
E	463	HIS	-	expression tag	UNP P15005
E	464	HIS	-	expression tag	UNP P15005
E	465	HIS	-	expression tag	UNP P15005
E	466	HIS	-	expression tag	UNP P15005
E	467	HIS	-	expression tag	UNP P15005
E	468	HIS	-	expression tag	UNP P15005
F	460	SER	-	expression tag	UNP P15005
F	461	GLY	-	expression tag	UNP P15005
F	462	SER	-	expression tag	UNP P15005

Continued on next page...

Continued from previous page...

Chain	Residue	Modelled	Actual	Comment	Reference
F	463	HIS	-	expression tag	UNP P15005
F	464	HIS	-	expression tag	UNP P15005
F	465	HIS	-	expression tag	UNP P15005
F	466	HIS	-	expression tag	UNP P15005
F	467	HIS	-	expression tag	UNP P15005
F	468	HIS	-	expression tag	UNP P15005
G	460	SER	-	expression tag	UNP P15005
G	461	GLY	-	expression tag	UNP P15005
G	462	SER	-	expression tag	UNP P15005
G	463	HIS	-	expression tag	UNP P15005
G	464	HIS	-	expression tag	UNP P15005
G	465	HIS	-	expression tag	UNP P15005
G	466	HIS	-	expression tag	UNP P15005
G	467	HIS	-	expression tag	UNP P15005
G	468	HIS	-	expression tag	UNP P15005
H	460	SER	-	expression tag	UNP P15005
H	461	GLY	-	expression tag	UNP P15005
H	462	SER	-	expression tag	UNP P15005
H	463	HIS	-	expression tag	UNP P15005
H	464	HIS	-	expression tag	UNP P15005
H	465	HIS	-	expression tag	UNP P15005
H	466	HIS	-	expression tag	UNP P15005
H	467	HIS	-	expression tag	UNP P15005
H	468	HIS	-	expression tag	UNP P15005
I	460	SER	-	expression tag	UNP P15005
I	461	GLY	-	expression tag	UNP P15005
I	462	SER	-	expression tag	UNP P15005
I	463	HIS	-	expression tag	UNP P15005
I	464	HIS	-	expression tag	UNP P15005
I	465	HIS	-	expression tag	UNP P15005
I	466	HIS	-	expression tag	UNP P15005
I	467	HIS	-	expression tag	UNP P15005
I	468	HIS	-	expression tag	UNP P15005
J	460	SER	-	expression tag	UNP P15005
J	461	GLY	-	expression tag	UNP P15005
J	462	SER	-	expression tag	UNP P15005
J	463	HIS	-	expression tag	UNP P15005
J	464	HIS	-	expression tag	UNP P15005
J	465	HIS	-	expression tag	UNP P15005
J	466	HIS	-	expression tag	UNP P15005
J	467	HIS	-	expression tag	UNP P15005
J	468	HIS	-	expression tag	UNP P15005

Continued on next page...

Continued from previous page...

Chain	Residue	Modelled	Actual	Comment	Reference
K	460	SER	-	expression tag	UNP P15005
K	461	GLY	-	expression tag	UNP P15005
K	462	SER	-	expression tag	UNP P15005
K	463	HIS	-	expression tag	UNP P15005
K	464	HIS	-	expression tag	UNP P15005
K	465	HIS	-	expression tag	UNP P15005
K	466	HIS	-	expression tag	UNP P15005
K	467	HIS	-	expression tag	UNP P15005
K	468	HIS	-	expression tag	UNP P15005
L	460	SER	-	expression tag	UNP P15005
L	461	GLY	-	expression tag	UNP P15005
L	462	SER	-	expression tag	UNP P15005
L	463	HIS	-	expression tag	UNP P15005
L	464	HIS	-	expression tag	UNP P15005
L	465	HIS	-	expression tag	UNP P15005
L	466	HIS	-	expression tag	UNP P15005
L	467	HIS	-	expression tag	UNP P15005
L	468	HIS	-	expression tag	UNP P15005

- Molecule 2 is a protein called Protein McrC.

Mol	Chain	Residues	Atoms					AltConf	Trace	
			Total	C	H	N	O			S
2	M	336	Total	C	H	N	O	S	0	0
			5538	1780	2772	475	502	9		
2	N	336	Total	C	H	N	O	S	0	0
			5538	1780	2772	475	502	9		

- Molecule 3 is PHOSPHOAMINOPHOSPHONIC ACID-GUANYLATE ESTER (three-letter code: GNP) (formula: C₁₀H₁₇N₆O₁₃P₃) (labeled as "Ligand of Interest" by depositor).

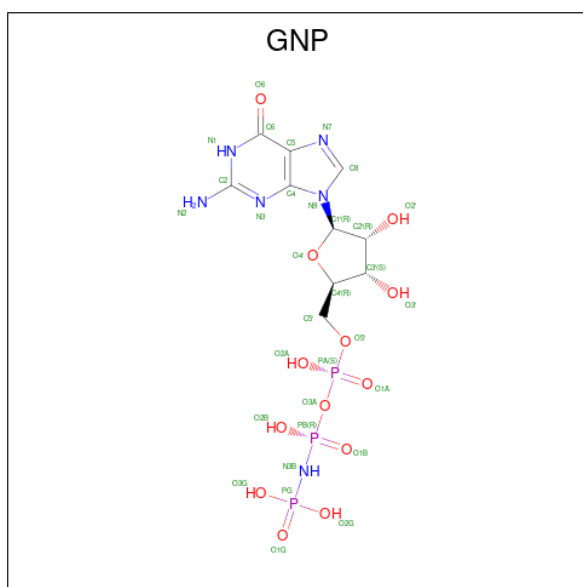

Mol	Chain	Residues	Atoms					AltConf	
			Total	C	H	N	O		P
3	A	1	45	10	13	6	13	3	0
3	B	1	45	10	13	6	13	3	0
3	C	1	45	10	13	6	13	3	0
3	G	1	45	10	13	6	13	3	0
3	H	1	45	10	13	6	13	3	0
3	I	1	45	10	13	6	13	3	0

- Molecule 4 is MAGNESIUM ION (three-letter code: MG) (formula: Mg).

Mol	Chain	Residues	Atoms		AltConf
			Total	Mg	
4	A	1	1	1	0
4	B	1	1	1	0
4	C	1	1	1	0
4	G	1	1	1	0
4	H	1	1	1	0
4	I	1	1	1	0

- Molecule 5 is GUANOSINE-5'-DIPHOSPHATE (three-letter code: GDP) (formula: $C_{10}H_{15}N_5O_{11}P_2$) (labeled as "Ligand of Interest" by depositor).

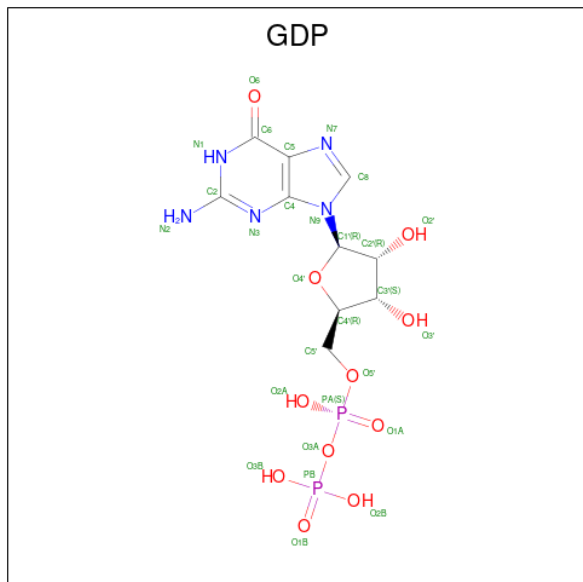

Mol	Chain	Residues	Atoms					AltConf	
			Total	C	H	N	O		P
5	D	1	Total	C	H	N	O	P	0
			40	10	12	5	11	2	
5	E	1	Total	C	H	N	O	P	0
			40	10	12	5	11	2	
5	F	1	Total	C	H	N	O	P	0
			40	10	12	5	11	2	
5	J	1	Total	C	H	N	O	P	0
			40	10	12	5	11	2	
5	K	1	Total	C	H	N	O	P	0
			40	10	12	5	11	2	
5	L	1	Total	C	H	N	O	P	0
			40	10	12	5	11	2	

3 Residue-property plots [i](#)

These plots are drawn for all protein, RNA, DNA and oligosaccharide chains in the entry. The first graphic for a chain summarises the proportions of the various outlier classes displayed in the second graphic. The second graphic shows the sequence view annotated by issues in geometry and atom inclusion in map density. Residues are color-coded according to the number of geometric quality criteria for which they contain at least one outlier: green = 0, yellow = 1, orange = 2 and red = 3 or more. A red diamond above a residue indicates a poor fit to the EM map for this residue (all-atom inclusion < 40%). Stretches of 2 or more consecutive residues without any outlier are shown as a green connector. Residues present in the sample, but not in the model, are shown in grey.

- Molecule 1: 5-methylcytosine-specific restriction enzyme B

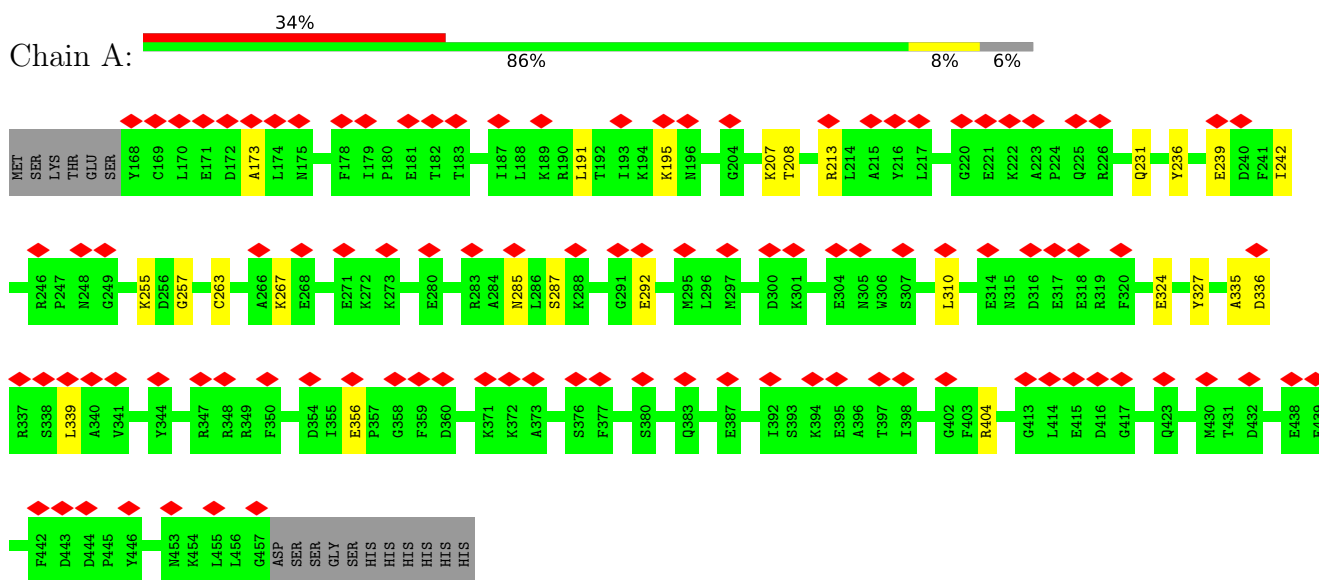

- Molecule 1: 5-methylcytosine-specific restriction enzyme B

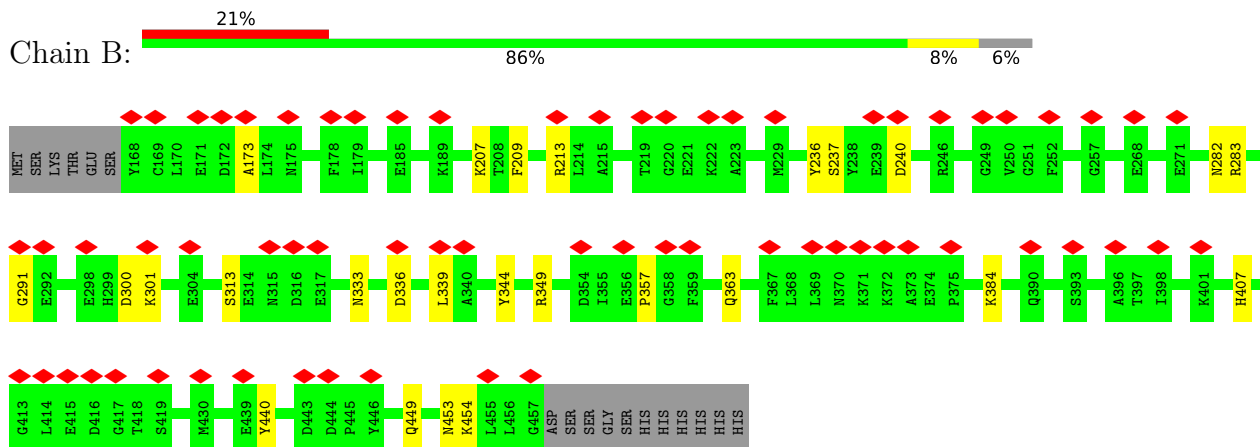

- Molecule 1: 5-methylcytosine-specific restriction enzyme B

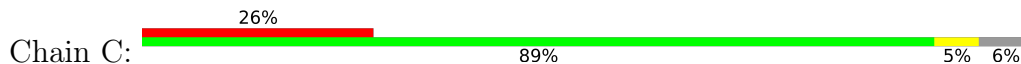

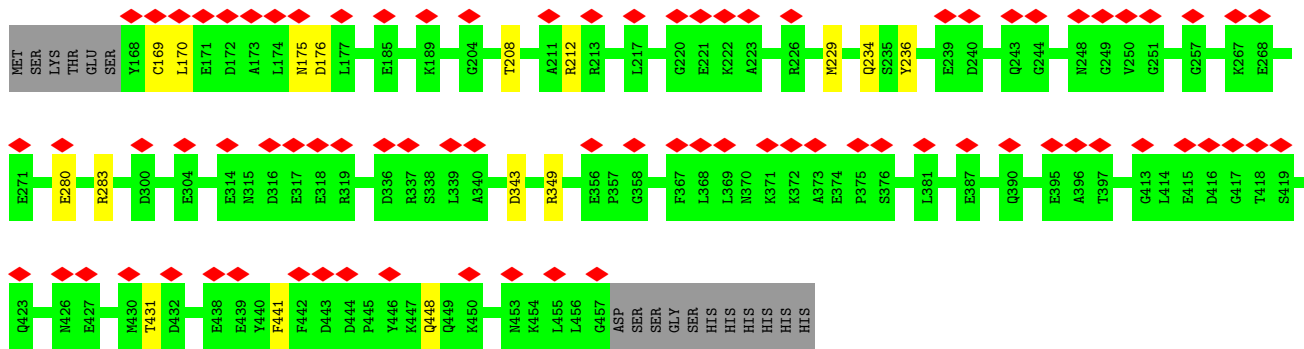

• Molecule 1: 5-methylcytosine-specific restriction enzyme B

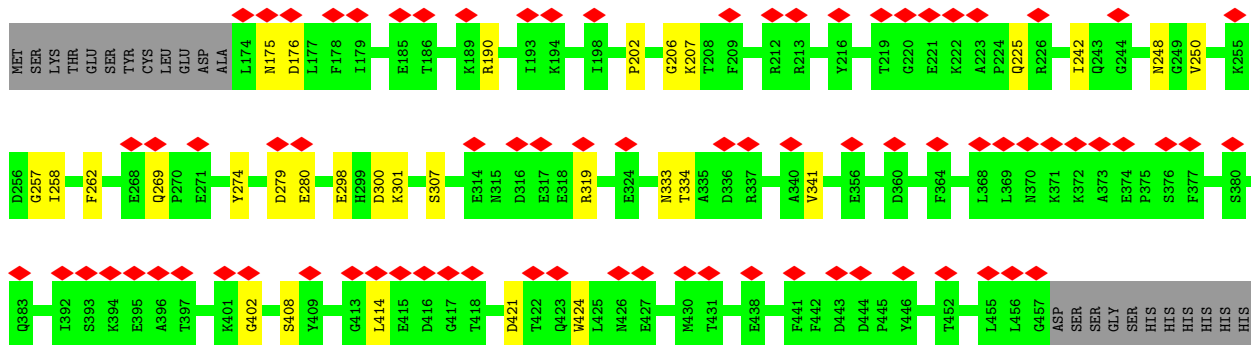
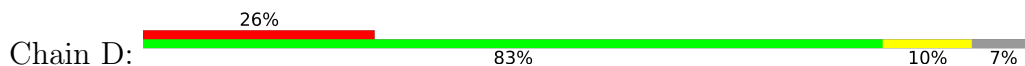

• Molecule 1: 5-methylcytosine-specific restriction enzyme B

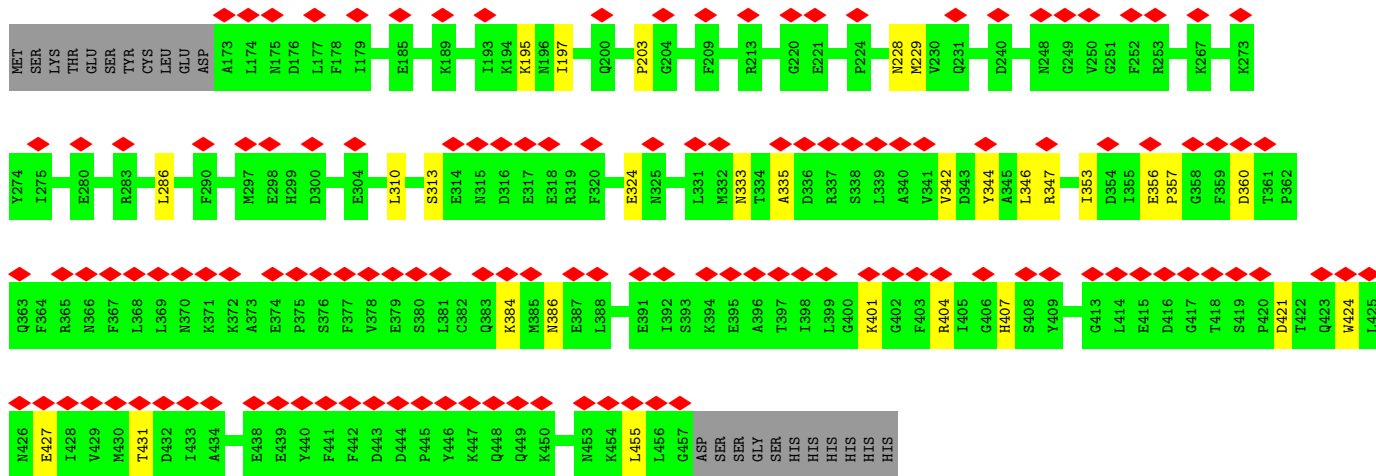
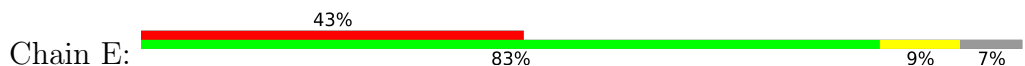

• Molecule 1: 5-methylcytosine-specific restriction enzyme B

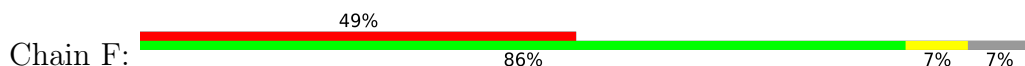

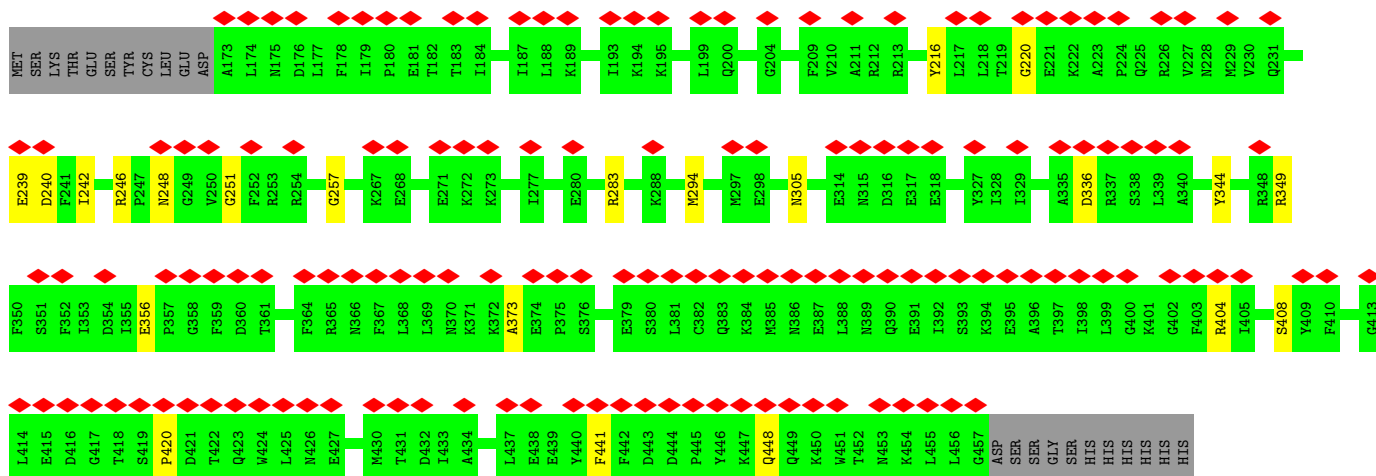

• Molecule 1: 5-methylcytosine-specific restriction enzyme B

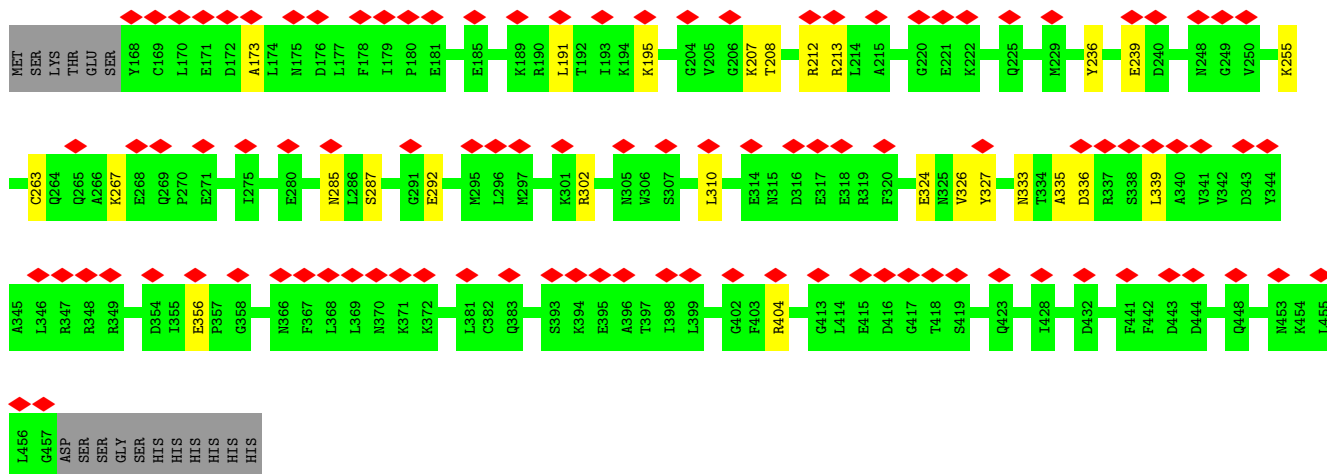
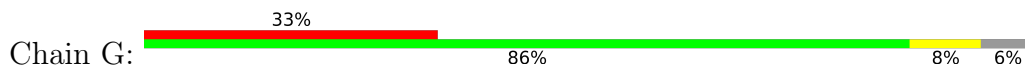

• Molecule 1: 5-methylcytosine-specific restriction enzyme B

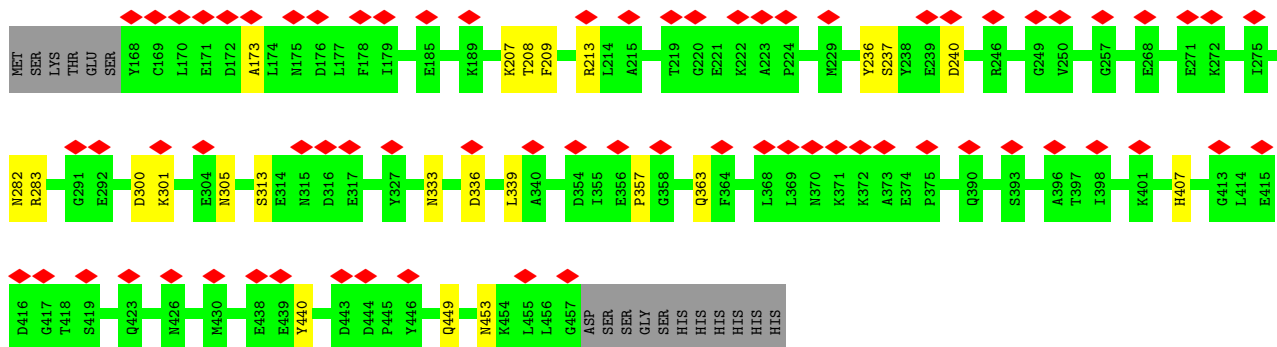
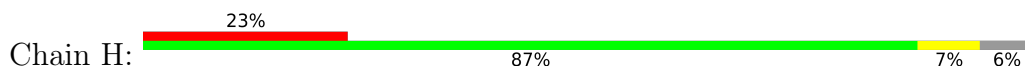

• Molecule 1: 5-methylcytosine-specific restriction enzyme B

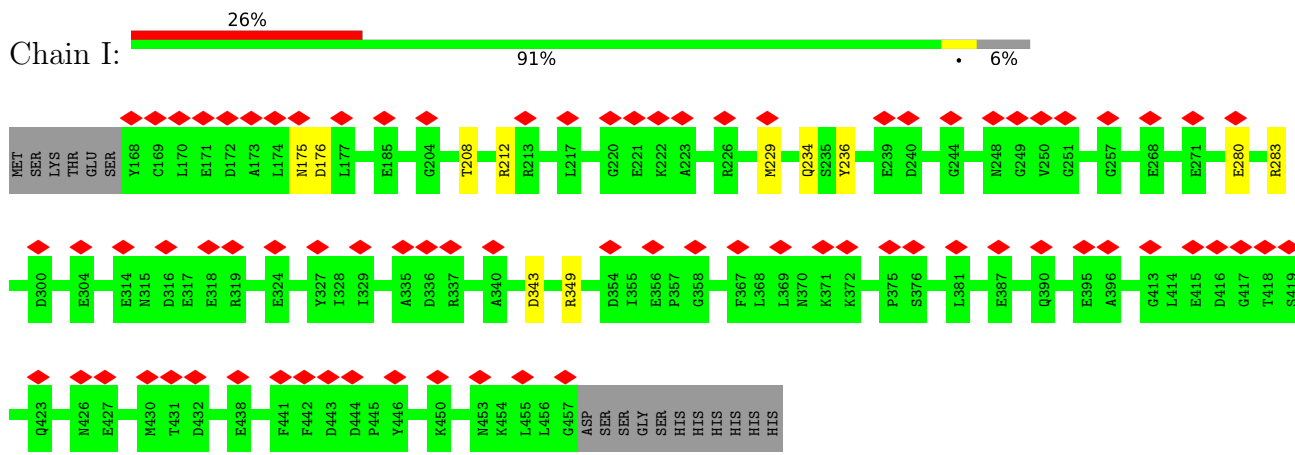

• Molecule 1: 5-methylcytosine-specific restriction enzyme B

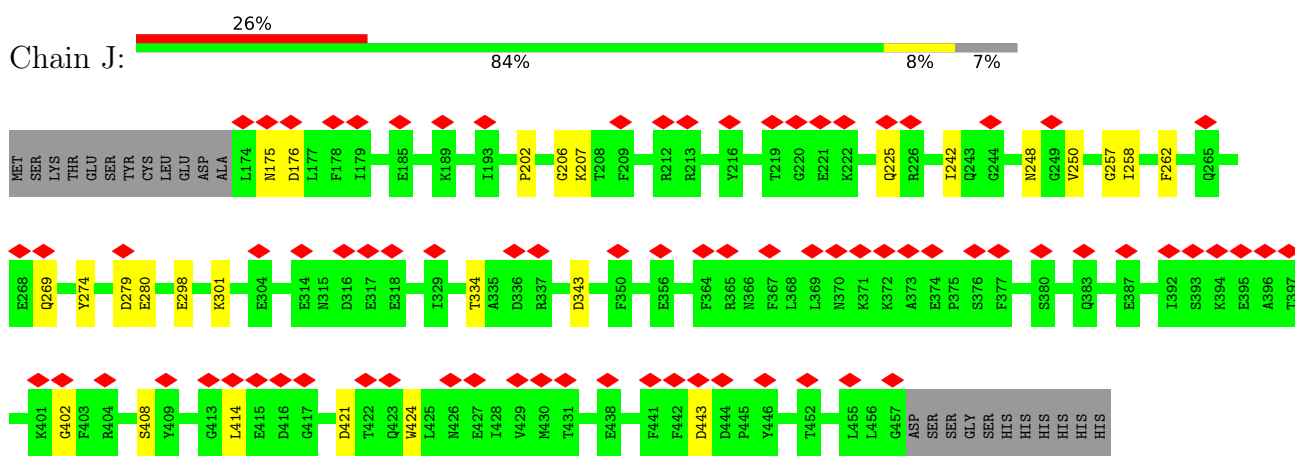

• Molecule 1: 5-methylcytosine-specific restriction enzyme B

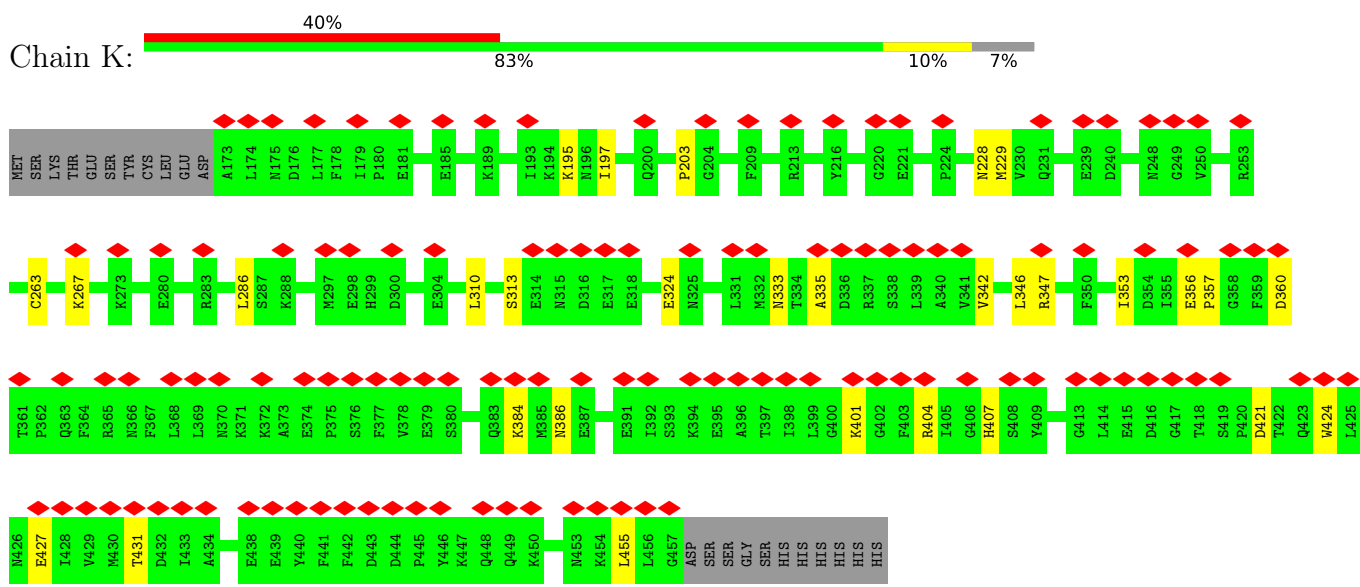

• Molecule 1: 5-methylcytosine-specific restriction enzyme B

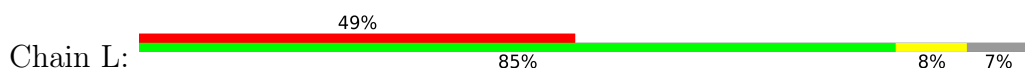

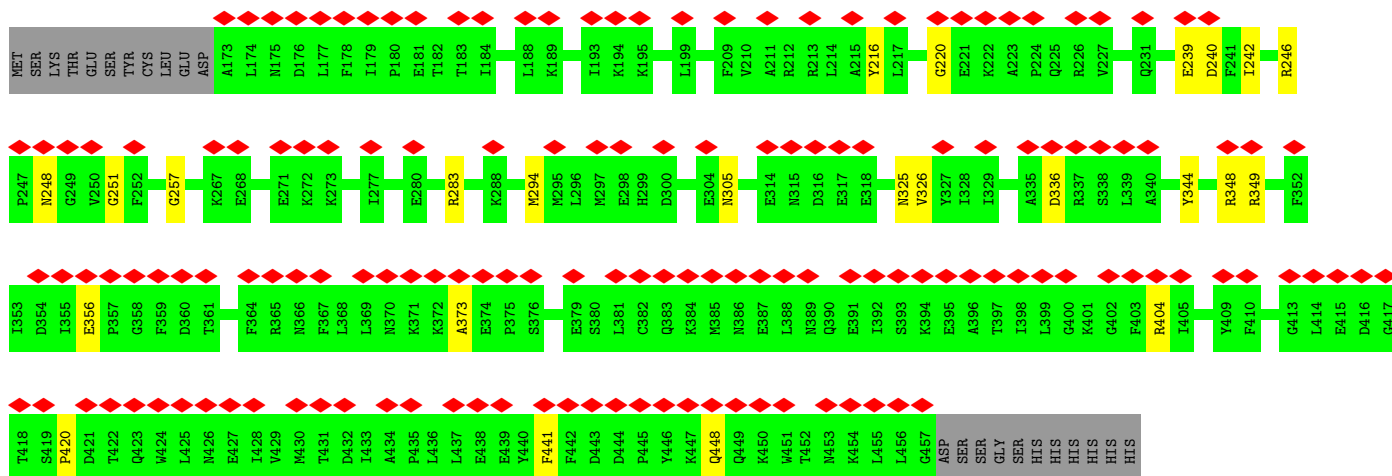

• Molecule 2: Protein McrC

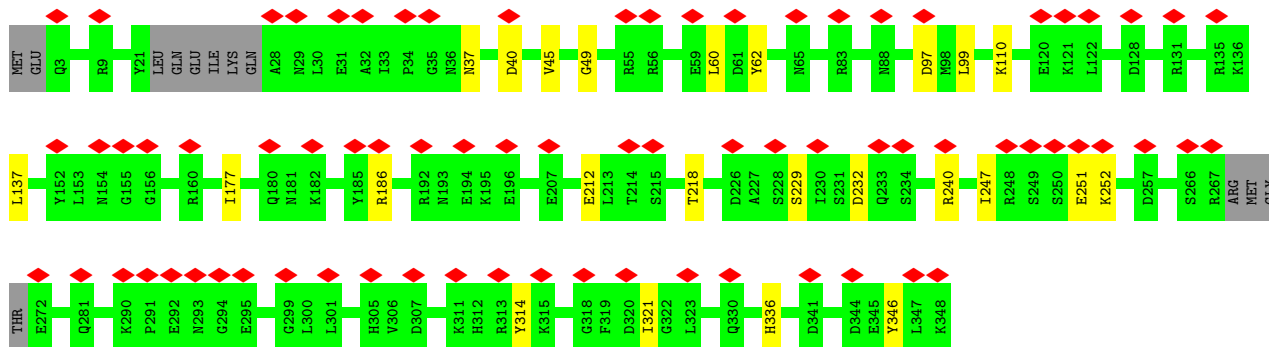
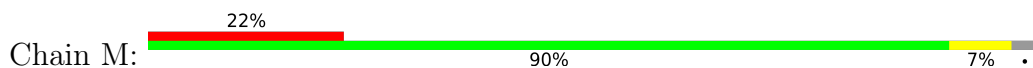

• Molecule 2: Protein McrC

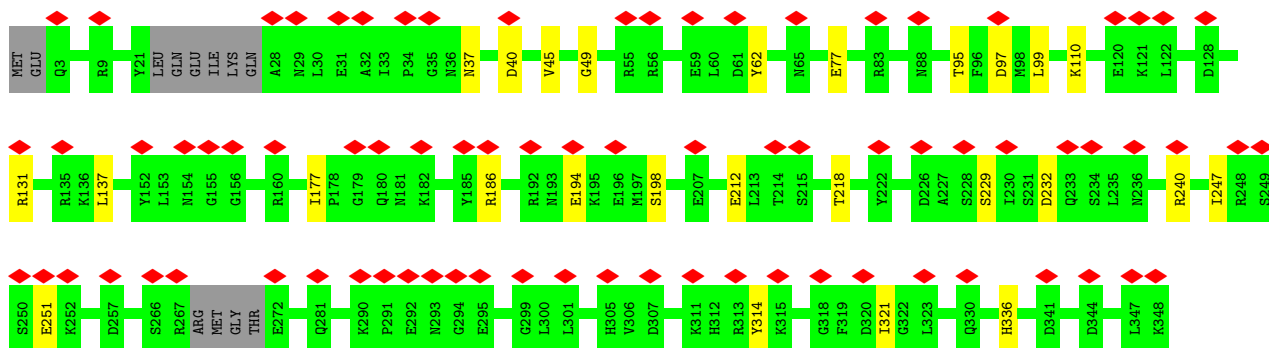
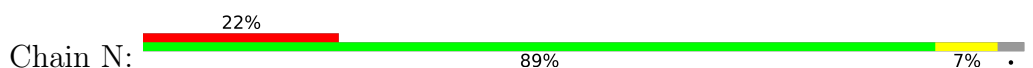

4 Experimental information

Property	Value	Source
EM reconstruction method	SINGLE PARTICLE	Depositor
Imposed symmetry	POINT, C2	Depositor
Number of particles used	225201	Depositor
Resolution determination method	FSC 0.143 CUT-OFF	Depositor
CTF correction method	PHASE FLIPPING AND AMPLITUDE CORRECTION	Depositor
Microscope	FEI TITAN KRIOS	Depositor
Voltage (kV)	300	Depositor
Electron dose ($e^-/\text{\AA}^2$)	1.5	Depositor
Minimum defocus (nm)	300	Depositor
Maximum defocus (nm)	5000	Depositor
Magnification	130000	Depositor
Image detector	GATAN K2 SUMMIT (4k x 4k)	Depositor
Maximum map value	0.085	Depositor
Minimum map value	-0.049	Depositor
Average map value	0.001	Depositor
Map value standard deviation	0.005	Depositor
Recommended contour level	0.026	Depositor
Map size (Å)	251.99998, 251.99998, 251.99998	wwPDB
Map dimensions	240, 240, 240	wwPDB
Map angles (°)	90.0, 90.0, 90.0	wwPDB
Pixel spacing (Å)	1.05, 1.05, 1.05	Depositor

5 Model quality [i](#)

5.1 Standard geometry [i](#)

Bond lengths and bond angles in the following residue types are not validated in this section: MG, GNP, GDP

The Z score for a bond length (or angle) is the number of standard deviations the observed value is removed from the expected value. A bond length (or angle) with $|Z| > 5$ is considered an outlier worth inspection. RMSZ is the root-mean-square of all Z scores of the bond lengths (or angles).

Mol	Chain	Bond lengths		Bond angles	
		RMSZ	# Z >5	RMSZ	# Z >5
1	A	0.33	0/2438	0.56	0/3292
1	B	0.33	0/2438	0.56	0/3292
1	C	0.34	0/2438	0.56	0/3292
1	D	0.34	0/2389	0.55	0/3225
1	E	0.33	0/2394	0.56	0/3232
1	F	0.32	0/2394	0.56	0/3232
1	G	0.33	0/2438	0.56	0/3292
1	H	0.33	0/2438	0.56	0/3292
1	I	0.34	0/2438	0.56	0/3292
1	J	0.34	0/2389	0.55	0/3225
1	K	0.33	0/2394	0.56	0/3232
1	L	0.32	0/2394	0.56	0/3232
2	M	0.33	0/2829	0.57	0/3821
2	N	0.33	0/2829	0.57	0/3821
All	All	0.33	0/34640	0.56	0/46772

There are no bond length outliers.

There are no bond angle outliers.

There are no chirality outliers.

There are no planarity outliers.

5.2 Too-close contacts [i](#)

In the following table, the Non-H and H(model) columns list the number of non-hydrogen atoms and hydrogen atoms in the chain respectively. The H(added) column lists the number of hydrogen atoms added and optimized by MolProbity. The Clashes column lists the number of clashes within the asymmetric unit, whereas Symm-Clashes lists symmetry-related clashes.

Mol	Chain	Non-H	H(model)	H(added)	Clashes	Symm-Clashes
1	A	2382	2338	2339	16	0
1	B	2382	2337	2340	15	0
1	C	2382	2335	2339	12	0
1	D	2334	2299	2300	21	0
1	E	2339	2298	2305	17	0
1	F	2339	2305	2305	13	0
1	G	2382	2338	2339	16	0
1	H	2382	2337	2340	13	0
1	I	2382	2335	2339	9	0
1	J	2334	2299	2300	17	0
1	K	2339	2298	2305	17	0
1	L	2339	2305	2305	14	0
2	M	2766	2772	2772	15	0
2	N	2766	2772	2772	16	0
3	A	32	13	13	4	0
3	B	32	13	13	3	0
3	C	32	13	13	2	0
3	G	32	13	13	3	0
3	H	32	13	13	4	0
3	I	32	13	13	1	0
4	A	1	0	0	0	0
4	B	1	0	0	0	0
4	C	1	0	0	0	0
4	G	1	0	0	0	0
4	H	1	0	0	0	0
4	I	1	0	0	0	0
5	D	28	12	12	2	0
5	E	28	12	12	0	0
5	F	28	12	12	1	0
5	J	28	12	12	2	0
5	K	28	12	12	1	0
5	L	28	12	12	0	0
All	All	34214	33518	33550	192	0

The all-atom clashscore is defined as the number of clashes found per 1000 atoms (including hydrogen atoms). The all-atom clashscore for this structure is 3.

All (192) close contacts within the same asymmetric unit are listed below, sorted by their clash magnitude.

Atom-1	Atom-2	Interatomic distance (Å)	Clash overlap (Å)
1:B:357:PRO:O	1:B:407:HIS:ND1	2.14	0.79
1:H:357:PRO:O	1:H:407:HIS:ND1	2.14	0.79

Continued on next page...

Continued from previous page...

Atom-1	Atom-2	Interatomic distance (Å)	Clash overlap (Å)
1:L:356:GLU:OE1	1:L:404:ARG:NH2	2.16	0.79
1:F:356:GLU:OE1	1:F:404:ARG:NH2	2.16	0.78
1:E:360:ASP:OD1	1:E:386:ASN:ND2	2.17	0.78
1:K:360:ASP:OD1	1:K:386:ASN:ND2	2.17	0.78
1:G:212:ARG:NH1	1:H:305:ASN:OD1	2.18	0.77
1:F:441:PHE:O	1:F:448:GLN:NE2	2.18	0.77
1:G:255:LYS:NZ	1:H:313:SER:O	2.17	0.77
1:L:441:PHE:O	1:L:448:GLN:NE2	2.19	0.77
1:D:408:SER:OG	5:D:1001:GDP:O4'	2.02	0.76
1:J:408:SER:OG	5:J:1001:GDP:O4'	2.02	0.76
1:A:231:GLN:NE2	1:B:291:GLY:O	2.18	0.75
1:F:248:ASN:ND2	1:F:251:GLY:O	2.20	0.75
1:L:248:ASN:ND2	1:L:251:GLY:O	2.20	0.74
1:I:283:ARG:O	2:N:62:TYR:OH	2.04	0.73
1:K:195:LYS:NZ	1:K:324:GLU:O	2.22	0.73
1:E:195:LYS:NZ	1:E:324:GLU:O	2.22	0.72
1:F:240:ASP:OD1	1:F:246:ARG:NH1	2.23	0.72
1:D:269:GLN:OE1	1:D:274:TYR:OH	2.08	0.72
1:J:269:GLN:OE1	1:J:274:TYR:OH	2.08	0.71
1:L:240:ASP:OD1	1:L:246:ARG:NH1	2.23	0.71
1:J:298:GLU:OE1	1:J:301:LYS:NZ	2.24	0.71
1:D:298:GLU:OE1	1:D:301:LYS:NZ	2.24	0.71
1:E:203:PRO:HD3	1:E:335:ALA:HB2	1.73	0.70
1:G:173:ALA:O	1:G:213:ARG:NH1	2.25	0.69
1:K:203:PRO:HD3	1:K:335:ALA:HB2	1.73	0.69
1:A:173:ALA:O	1:A:213:ARG:NH1	2.25	0.69
1:A:356:GLU:OE1	1:A:404:ARG:NH2	2.26	0.69
1:G:356:GLU:OE1	1:G:404:ARG:NH2	2.26	0.68
2:M:110:LYS:NZ	2:M:137:LEU:O	2.26	0.68
1:H:283:ARG:NH2	1:I:343:ASP:OD2	2.27	0.68
2:N:110:LYS:NZ	2:N:137:LEU:O	2.26	0.68
1:E:356:GLU:OE2	1:E:404:ARG:NH1	2.28	0.66
1:K:356:GLU:OE2	1:K:404:ARG:NH1	2.28	0.66
1:I:208:THR:N	3:I:1001:GNP:O1A	2.29	0.66
1:C:208:THR:N	3:C:1001:GNP:O1A	2.29	0.64
1:C:283:ARG:O	2:M:62:TYR:OH	2.09	0.64
1:D:333:ASN:ND2	1:E:344:TYR:OH	2.31	0.63
1:L:294:MET:SD	1:L:349:ARG:NH1	2.72	0.63
3:H:1001:GNP:O2G	1:I:349:ARG:NH2	2.32	0.62
1:H:173:ALA:O	1:H:213:ARG:NH2	2.33	0.62
1:B:283:ARG:NH2	1:C:343:ASP:OD2	2.33	0.62

Continued on next page...

Continued from previous page...

Atom-1	Atom-2	Interatomic distance (Å)	Clash overlap (Å)
1:F:294:MET:SD	1:F:349:ARG:NH1	2.72	0.62
1:A:255:LYS:NZ	1:B:313:SER:O	2.33	0.61
1:B:173:ALA:O	1:B:213:ARG:NH2	2.33	0.61
1:C:175:ASN:OD1	1:C:176:ASP:N	2.35	0.60
1:E:357:PRO:O	1:E:407:HIS:ND1	2.34	0.59
1:K:357:PRO:O	1:K:407:HIS:ND1	2.34	0.59
1:I:175:ASN:OD1	1:I:176:ASP:N	2.35	0.59
1:F:239:GLU:N	1:F:239:GLU:OE1	2.36	0.58
1:J:258:ILE:O	1:J:262:PHE:N	2.35	0.58
1:J:443:ASP:OD2	2:N:131:ARG:NH2	2.36	0.58
1:I:234:GLN:NE2	2:N:99:LEU:HD23	2.19	0.58
1:L:239:GLU:OE1	1:L:239:GLU:N	2.37	0.57
1:F:373:ALA:HB2	1:F:420:PRO:HG2	1.87	0.57
1:D:258:ILE:O	1:D:262:PHE:N	2.35	0.57
1:J:414:LEU:HD21	1:J:424:TRP:CD1	2.40	0.57
1:K:286:LEU:HD22	1:K:346:LEU:HD23	1.86	0.57
1:A:195:LYS:NZ	1:A:324:GLU:O	2.24	0.56
1:E:421:ASP:OD1	1:E:424:TRP:N	2.37	0.56
1:E:286:LEU:HD22	1:E:346:LEU:HD23	1.86	0.56
1:D:414:LEU:HD21	1:D:424:TRP:CD1	2.40	0.56
1:C:431:THR:HG21	1:D:190:ARG:NE	2.21	0.56
1:A:239:GLU:N	1:A:239:GLU:OE1	2.39	0.55
1:L:373:ALA:HB2	1:L:420:PRO:HG2	1.87	0.55
3:A:1001:GNP:O1G	1:B:349:ARG:NH2	2.36	0.55
1:J:242:ILE:O	1:J:257:GLY:N	2.40	0.55
3:B:1001:GNP:O2G	1:C:349:ARG:NH2	2.40	0.55
1:K:421:ASP:OD1	1:K:424:TRP:N	2.37	0.54
1:F:242:ILE:O	1:F:257:GLY:N	2.40	0.54
1:L:242:ILE:O	1:L:257:GLY:N	2.40	0.54
1:G:239:GLU:N	1:G:239:GLU:OE1	2.40	0.54
1:C:431:THR:HG21	1:D:190:ARG:HE	1.72	0.54
1:J:248:ASN:OD1	1:J:250:VAL:N	2.42	0.53
1:D:341:VAL:HG22	2:M:60:LEU:HD11	1.90	0.53
1:B:237:SER:N	1:B:240:ASP:OD2	2.41	0.52
1:H:237:SER:N	1:H:240:ASP:OD2	2.41	0.52
1:D:248:ASN:OD1	1:D:250:VAL:N	2.42	0.52
1:G:292:GLU:OE1	1:G:310:LEU:HD23	2.10	0.52
1:D:202:PRO:O	1:D:207:LYS:NZ	2.43	0.52
1:D:225:GLN:OE1	1:D:225:GLN:N	2.41	0.52
1:A:292:GLU:OE1	1:A:310:LEU:HD23	2.10	0.52
1:K:427:GLU:O	1:K:431:THR:OG1	2.17	0.51

Continued on next page...

Continued from previous page...

Atom-1	Atom-2	Interatomic distance (Å)	Clash overlap (Å)
3:C:1001:GNP:O3'	1:D:300:ASP:OD2	2.17	0.51
1:D:242:ILE:O	1:D:257:GLY:N	2.40	0.51
1:E:384:LYS:NZ	1:E:455:LEU:O	2.28	0.51
1:K:197:ILE:HD11	1:K:353:ILE:HD12	1.93	0.51
1:E:333:ASN:ND2	1:F:344:TYR:OH	2.44	0.51
1:J:202:PRO:O	1:J:207:LYS:NZ	2.43	0.51
1:E:427:GLU:O	1:E:431:THR:OG1	2.17	0.50
1:K:384:LYS:NZ	1:K:455:LEU:O	2.28	0.50
1:E:197:ILE:HD11	1:E:353:ILE:HD12	1.93	0.50
2:N:62:TYR:CZ	2:N:99:LEU:HD22	2.47	0.50
1:A:335:ALA:HB1	1:B:344:TYR:HB2	1.94	0.50
1:E:401:LYS:O	1:E:404:ARG:NH2	2.45	0.50
1:A:207:LYS:NZ	3:A:1001:GNP:O2B	2.43	0.49
1:D:279:ASP:OD1	1:D:280:GLU:N	2.45	0.49
2:M:62:TYR:CZ	2:M:99:LEU:HD22	2.47	0.49
1:K:401:LYS:O	1:K:404:ARG:NH2	2.45	0.49
1:K:333:ASN:ND2	1:L:344:TYR:OH	2.46	0.49
1:I:212:ARG:NH1	1:I:229:MET:SD	2.86	0.49
1:C:212:ARG:NH1	1:C:229:MET:SD	2.86	0.49
2:M:229:SER:OG	2:M:232:ASP:O	2.30	0.49
1:I:280:GLU:OE2	1:I:283:ARG:NH2	2.46	0.49
2:N:229:SER:OG	2:N:232:ASP:O	2.30	0.49
1:B:207:LYS:NZ	3:B:1001:GNP:O1B	2.46	0.49
1:J:279:ASP:OD1	1:J:280:GLU:N	2.45	0.48
1:G:208:THR:OG1	3:G:1001:GNP:O1B	2.31	0.48
1:A:336:ASP:OD1	1:A:339:LEU:N	2.46	0.48
1:C:280:GLU:OE2	1:C:283:ARG:NH2	2.46	0.48
1:G:263:CYS:O	1:G:267:LYS:N	2.46	0.48
1:H:363:GLN:O	1:H:363:GLN:NE2	2.45	0.48
1:A:208:THR:OG1	3:A:1001:GNP:O1B	2.31	0.48
2:M:177:ILE:O	2:M:186:ARG:N	2.41	0.48
1:H:300:ASP:OD1	1:H:301:LYS:N	2.47	0.47
1:F:408:SER:OG	5:F:1001:GDP:O4'	2.27	0.47
2:M:37:ASN:ND2	2:M:40:ASP:OD2	2.47	0.47
1:B:300:ASP:OD1	1:B:301:LYS:N	2.47	0.47
2:N:97:ASP:OD1	2:N:97:ASP:N	2.47	0.47
1:B:363:GLN:O	1:B:363:GLN:NE2	2.46	0.47
1:L:216:TYR:O	1:L:220:GLY:N	2.48	0.47
2:N:37:ASN:ND2	2:N:40:ASP:OD2	2.47	0.47
2:N:177:ILE:O	2:N:186:ARG:N	2.41	0.46
2:N:212:GLU:OE1	2:N:336:HIS:NE2	2.48	0.46

Continued on next page...

Continued from previous page...

Atom-1	Atom-2	Interatomic distance (Å)	Clash overlap (Å)
1:K:342:VAL:O	1:K:347:ARG:NH2	2.46	0.46
1:J:206:GLY:N	5:J:1001:GDP:O3B	2.49	0.46
1:D:414:LEU:HD21	1:D:424:TRP:NE1	2.31	0.46
1:G:207:LYS:NZ	3:G:1001:GNP:O2B	2.43	0.46
1:D:206:GLY:N	5:D:1001:GDP:O3B	2.49	0.46
1:G:195:LYS:NZ	1:G:324:GLU:O	2.24	0.46
1:J:414:LEU:HD21	1:J:424:TRP:NE1	2.31	0.46
1:E:310:LEU:N	1:E:313:SER:OG	2.49	0.45
1:C:234:GLN:NE2	2:M:99:LEU:HD23	2.30	0.45
1:F:216:TYR:O	1:F:220:GLY:N	2.48	0.45
1:G:336:ASP:OD1	1:G:339:LEU:N	2.46	0.45
1:H:449:GLN:O	1:H:453:ASN:ND2	2.50	0.45
1:B:449:GLN:O	1:B:453:ASN:ND2	2.50	0.45
1:G:207:LYS:NZ	3:G:1001:GNP:O2G	2.48	0.45
1:G:285:ASN:ND2	1:G:287:SER:OG	2.50	0.45
1:J:421:ASP:OD1	1:J:424:TRP:N	2.43	0.45
1:K:310:LEU:N	1:K:313:SER:OG	2.49	0.45
1:A:285:ASN:ND2	1:A:287:SER:OG	2.50	0.45
1:H:209:PHE:N	3:H:1001:GNP:O1A	2.50	0.44
1:F:283:ARG:NH2	1:F:336:ASP:OD2	2.50	0.44
1:D:334:THR:OG1	1:D:402:GLY:O	2.34	0.44
1:H:208:THR:OG1	3:H:1001:GNP:O2B	2.26	0.43
1:L:283:ARG:NH2	1:L:336:ASP:OD2	2.50	0.43
2:N:251:GLU:OE2	2:N:251:GLU:N	2.44	0.43
1:A:263:CYS:O	1:A:267:LYS:N	2.46	0.43
1:J:225:GLN:OE1	1:J:225:GLN:N	2.41	0.43
1:L:305:ASN:N	1:L:305:ASN:OD1	2.51	0.43
1:D:307:SER:OG	1:D:319:ARG:NE	2.39	0.43
1:D:421:ASP:OD1	1:D:424:TRP:N	2.43	0.43
2:M:314:TYR:N	2:M:321:ILE:O	2.51	0.43
1:E:342:VAL:O	1:E:347:ARG:NH2	2.46	0.43
1:F:305:ASN:N	1:F:305:ASN:OD1	2.51	0.43
2:M:251:GLU:OE2	2:M:251:GLU:N	2.44	0.43
1:J:334:THR:OG1	1:J:402:GLY:O	2.34	0.43
2:N:218:THR:HG22	2:N:247:ILE:HG22	2.01	0.43
1:H:207:LYS:NZ	3:H:1001:GNP:O1B	2.46	0.43
2:M:218:THR:HG22	2:M:247:ILE:HG22	2.01	0.42
1:A:207:LYS:NZ	3:A:1001:GNP:O2G	2.48	0.42
2:M:212:GLU:OE1	2:M:336:HIS:NE2	2.48	0.42
1:G:302:ARG:NH2	1:G:326:VAL:O	2.45	0.42
1:B:209:PHE:N	3:B:1001:GNP:O1A	2.50	0.42

Continued on next page...

Continued from previous page...

Atom-1	Atom-2	Interatomic distance (Å)	Clash overlap (Å)
1:B:282:ASN:ND2	1:B:339:LEU:O	2.50	0.42
1:A:242:ILE:O	1:A:257:GLY:N	2.46	0.42
1:K:228:ASN:OD1	1:K:229:MET:N	2.53	0.42
5:K:1001:GDP:O3B	1:L:348:ARG:NH1	2.53	0.42
2:N:194:GLU:O	2:N:198:SER:N	2.45	0.41
2:M:252:LYS:NZ	2:M:346:TYR:O	2.44	0.41
1:C:441:PHE:O	1:C:448:GLN:NE2	2.45	0.41
1:E:228:ASN:OD1	1:E:229:MET:N	2.53	0.41
1:H:282:ASN:ND2	1:H:339:LEU:O	2.50	0.41
2:N:45:VAL:O	2:N:49:GLY:N	2.49	0.41
1:A:191:LEU:HD11	1:A:327:TYR:HB3	2.03	0.41
1:B:384:LYS:NZ	1:B:454:LYS:O	2.27	0.41
2:M:45:VAL:O	2:M:49:GLY:N	2.49	0.41
1:J:175:ASN:OD1	1:J:176:ASP:N	2.54	0.41
2:N:77:GLU:OE2	2:N:95:THR:OG1	2.39	0.41
1:G:333:ASN:OD1	1:G:335:ALA:HB3	2.21	0.41
2:N:314:TYR:N	2:N:321:ILE:O	2.51	0.40
1:E:203:PRO:CD	1:E:335:ALA:HB2	2.47	0.40
2:M:97:ASP:OD1	2:M:97:ASP:N	2.47	0.40
1:C:169:CYS:SG	1:C:170:LEU:N	2.95	0.40
1:G:191:LEU:HD11	1:G:327:TYR:HB3	2.03	0.40
1:K:203:PRO:CD	1:K:335:ALA:HB2	2.47	0.40
1:I:283:ARG:NH1	1:J:343:ASP:OD2	2.55	0.40
1:K:263:CYS:O	1:K:267:LYS:N	2.53	0.40
1:D:175:ASN:OD1	1:D:176:ASP:N	2.54	0.40
1:L:325:ASN:OD1	1:L:326:VAL:N	2.55	0.40

There are no symmetry-related clashes.

5.3 Torsion angles [\(i\)](#)

5.3.1 Protein backbone [\(i\)](#)

In the following table, the Percentiles column shows the percent Ramachandran outliers of the chain as a percentile score with respect to all PDB entries followed by that with respect to all EM entries.

The Analysed column shows the number of residues for which the backbone conformation was analysed, and the total number of residues.

Mol	Chain	Analysed	Favoured	Allowed	Outliers	Percentiles	
1	A	288/307 (94%)	278 (96%)	10 (4%)	0	100	100
1	B	288/307 (94%)	279 (97%)	9 (3%)	0	100	100
1	C	288/307 (94%)	276 (96%)	12 (4%)	0	100	100
1	D	282/307 (92%)	279 (99%)	3 (1%)	0	100	100
1	E	283/307 (92%)	274 (97%)	9 (3%)	0	100	100
1	F	283/307 (92%)	278 (98%)	5 (2%)	0	100	100
1	G	288/307 (94%)	278 (96%)	10 (4%)	0	100	100
1	H	288/307 (94%)	279 (97%)	9 (3%)	0	100	100
1	I	288/307 (94%)	276 (96%)	12 (4%)	0	100	100
1	J	282/307 (92%)	279 (99%)	3 (1%)	0	100	100
1	K	283/307 (92%)	274 (97%)	9 (3%)	0	100	100
1	L	283/307 (92%)	278 (98%)	5 (2%)	0	100	100
2	M	330/348 (95%)	319 (97%)	11 (3%)	0	100	100
2	N	330/348 (95%)	319 (97%)	11 (3%)	0	100	100
All	All	4084/4380 (93%)	3966 (97%)	118 (3%)	0	100	100

There are no Ramachandran outliers to report.

5.3.2 Protein sidechains [i](#)

In the following table, the Percentiles column shows the percent sidechain outliers of the chain as a percentile score with respect to all PDB entries followed by that with respect to all EM entries.

The Analysed column shows the number of residues for which the sidechain conformation was analysed, and the total number of residues.

Mol	Chain	Analysed	Rotameric	Outliers	Percentiles	
1	A	260/276 (94%)	259 (100%)	1 (0%)	91	94
1	B	260/276 (94%)	256 (98%)	4 (2%)	65	80
1	C	260/276 (94%)	259 (100%)	1 (0%)	91	94
1	D	255/276 (92%)	255 (100%)	0	100	100
1	E	255/276 (92%)	255 (100%)	0	100	100
1	F	255/276 (92%)	255 (100%)	0	100	100
1	G	260/276 (94%)	259 (100%)	1 (0%)	91	94

Continued on next page...

Continued from previous page...

Mol	Chain	Analysed	Rotameric	Outliers	Percentiles	
1	H	260/276 (94%)	256 (98%)	4 (2%)	65	80
1	I	260/276 (94%)	259 (100%)	1 (0%)	91	94
1	J	255/276 (92%)	255 (100%)	0	100	100
1	K	255/276 (92%)	255 (100%)	0	100	100
1	L	255/276 (92%)	255 (100%)	0	100	100
2	M	305/316 (96%)	304 (100%)	1 (0%)	92	95
2	N	305/316 (96%)	304 (100%)	1 (0%)	92	95
All	All	3700/3944 (94%)	3686 (100%)	14 (0%)	91	94

All (14) residues with a non-rotameric sidechain are listed below:

Mol	Chain	Res	Type
1	A	236	TYR
1	B	236	TYR
1	B	333	ASN
1	B	336	ASP
1	B	440	TYR
1	C	236	TYR
2	M	240	ARG
1	G	236	TYR
1	H	236	TYR
1	H	333	ASN
1	H	336	ASP
1	H	440	TYR
1	I	236	TYR
2	N	240	ARG

Sometimes sidechains can be flipped to improve hydrogen bonding and reduce clashes. All (10) such sidechains are listed below:

Mol	Chain	Res	Type
1	A	453	ASN
1	B	228	ASN
1	B	264	GLN
1	B	453	ASN
1	E	333	ASN
1	G	453	ASN
1	H	228	ASN
1	H	264	GLN

Continued on next page...

Continued from previous page...

Mol	Chain	Res	Type
1	H	453	ASN
1	K	333	ASN

5.3.3 RNA [i](#)

There are no RNA molecules in this entry.

5.4 Non-standard residues in protein, DNA, RNA chains [i](#)

There are no non-standard protein/DNA/RNA residues in this entry.

5.5 Carbohydrates [i](#)

There are no monosaccharides in this entry.

5.6 Ligand geometry [i](#)

Of 18 ligands modelled in this entry, 6 are monoatomic - leaving 12 for Mogul analysis.

In the following table, the Counts columns list the number of bonds (or angles) for which Mogul statistics could be retrieved, the number of bonds (or angles) that are observed in the model and the number of bonds (or angles) that are defined in the Chemical Component Dictionary. The Link column lists molecule types, if any, to which the group is linked. The Z score for a bond length (or angle) is the number of standard deviations the observed value is removed from the expected value. A bond length (or angle) with $|Z| > 2$ is considered an outlier worth inspection. RMSZ is the root-mean-square of all Z scores of the bond lengths (or angles).

Mol	Type	Chain	Res	Link	Bond lengths			Bond angles		
					Counts	RMSZ	# $ Z > 2$	Counts	RMSZ	# $ Z > 2$
3	GNP	C	1001	4	29,34,34	2.21	11 (37%)	33,54,54	2.08	8 (24%)
3	GNP	I	1001	4	29,34,34	2.20	11 (37%)	33,54,54	2.08	8 (24%)
5	GDP	J	1001	-	24,30,30	2.08	5 (20%)	30,47,47	1.69	5 (16%)
5	GDP	E	1001	-	24,30,30	2.16	3 (12%)	30,47,47	1.64	7 (23%)
5	GDP	L	1001	-	24,30,30	1.96	3 (12%)	30,47,47	1.78	6 (20%)
3	GNP	G	1001	4	29,34,34	2.07	10 (34%)	33,54,54	2.12	8 (24%)
3	GNP	H	1001	4	29,34,34	2.09	9 (31%)	33,54,54	1.98	7 (21%)
5	GDP	K	1001	-	24,30,30	2.17	3 (12%)	30,47,47	1.63	7 (23%)
5	GDP	D	1001	-	24,30,30	2.08	5 (20%)	30,47,47	1.69	5 (16%)

Mol	Type	Chain	Res	Link	Bond lengths			Bond angles		
					Counts	RMSZ	# Z > 2	Counts	RMSZ	# Z > 2
3	GNP	A	1001	4	29,34,34	2.08	11 (37%)	33,54,54	2.12	8 (24%)
5	GDP	F	1001	-	24,30,30	1.96	3 (12%)	30,47,47	1.78	6 (20%)
3	GNP	B	1001	4	29,34,34	2.10	9 (31%)	33,54,54	1.98	7 (21%)

In the following table, the Chirals column lists the number of chiral outliers, the number of chiral centers analysed, the number of these observed in the model and the number defined in the Chemical Component Dictionary. Similar counts are reported in the Torsion and Rings columns. '-' means no outliers of that kind were identified.

Mol	Type	Chain	Res	Link	Chirals	Torsions	Rings
3	GNP	C	1001	4	-	4/14/38/38	0/3/3/3
3	GNP	I	1001	4	-	4/14/38/38	0/3/3/3
5	GDP	J	1001	-	-	4/12/32/32	0/3/3/3
5	GDP	E	1001	-	-	0/12/32/32	0/3/3/3
5	GDP	L	1001	-	-	4/12/32/32	0/3/3/3
3	GNP	G	1001	4	-	4/14/38/38	0/3/3/3
3	GNP	H	1001	4	-	3/14/38/38	0/3/3/3
5	GDP	K	1001	-	-	0/12/32/32	0/3/3/3
5	GDP	D	1001	-	-	4/12/32/32	0/3/3/3
3	GNP	A	1001	4	-	4/14/38/38	0/3/3/3
5	GDP	F	1001	-	-	4/12/32/32	0/3/3/3
3	GNP	B	1001	4	-	3/14/38/38	0/3/3/3

All (83) bond length outliers are listed below:

Mol	Chain	Res	Type	Atoms	Z	Observed(Å)	Ideal(Å)
5	J	1001	GDP	C5-C6	-6.97	1.33	1.47
5	D	1001	GDP	C5-C6	-6.96	1.33	1.47
5	K	1001	GDP	C5-C6	-6.94	1.33	1.47
5	E	1001	GDP	C5-C6	-6.91	1.33	1.47
5	L	1001	GDP	C5-C6	-6.87	1.33	1.47
5	F	1001	GDP	C5-C6	-6.85	1.33	1.47
5	K	1001	GDP	O4'-C1'	5.13	1.48	1.41
5	E	1001	GDP	O4'-C1'	5.10	1.48	1.41
3	B	1001	GNP	C5-C6	-4.82	1.33	1.41
3	H	1001	GNP	C5-C6	-4.80	1.33	1.41
3	C	1001	GNP	O4'-C1'	4.77	1.47	1.41
3	I	1001	GNP	O4'-C1'	4.74	1.47	1.41
3	C	1001	GNP	C5-C6	-4.67	1.33	1.41

Continued on next page...

Continued from previous page...

Mol	Chain	Res	Type	Atoms	Z	Observed(Å)	Ideal(Å)
3	I	1001	GNP	C5-C6	-4.66	1.33	1.41
3	G	1001	GNP	C5-C6	-4.65	1.33	1.41
3	A	1001	GNP	C5-C6	-4.64	1.33	1.41
3	B	1001	GNP	C6-N1	4.08	1.40	1.33
3	H	1001	GNP	C6-N1	4.08	1.40	1.33
3	A	1001	GNP	C6-N1	3.88	1.39	1.33
3	C	1001	GNP	C6-N1	3.87	1.39	1.33
3	G	1001	GNP	C6-N1	3.87	1.39	1.33
3	I	1001	GNP	C6-N1	3.83	1.39	1.33
5	E	1001	GDP	C5-C4	-3.80	1.33	1.43
5	K	1001	GDP	C5-C4	-3.78	1.33	1.43
3	B	1001	GNP	O4'-C1'	3.72	1.46	1.41
3	H	1001	GNP	O4'-C1'	3.67	1.46	1.41
3	A	1001	GNP	PB-N3B	-3.54	1.54	1.63
5	J	1001	GDP	C5-C4	-3.54	1.34	1.43
5	L	1001	GDP	C5-C4	-3.52	1.34	1.43
3	G	1001	GNP	PB-N3B	-3.51	1.54	1.63
5	D	1001	GDP	C5-C4	-3.51	1.34	1.43
5	F	1001	GDP	C5-C4	-3.50	1.34	1.43
3	A	1001	GNP	PG-O2G	-3.44	1.47	1.56
5	D	1001	GDP	O4'-C1'	3.44	1.45	1.41
3	G	1001	GNP	PG-O2G	-3.43	1.47	1.56
5	J	1001	GDP	O4'-C1'	3.41	1.45	1.41
3	A	1001	GNP	PB-O2B	-3.30	1.47	1.56
3	C	1001	GNP	PB-O2B	-3.29	1.47	1.56
3	C	1001	GNP	PG-O2G	-3.28	1.47	1.56
3	G	1001	GNP	PB-O2B	-3.27	1.48	1.56
3	I	1001	GNP	PG-O2G	-3.26	1.48	1.56
3	I	1001	GNP	PB-O2B	-3.26	1.48	1.56
3	H	1001	GNP	PG-O2G	-3.25	1.48	1.56
3	B	1001	GNP	PB-O2B	-3.25	1.48	1.56
3	B	1001	GNP	PG-O2G	-3.24	1.48	1.56
3	H	1001	GNP	PB-O2B	-3.23	1.48	1.56
3	H	1001	GNP	PB-N3B	-3.23	1.54	1.63
3	B	1001	GNP	PB-N3B	-3.20	1.55	1.63
3	A	1001	GNP	PG-O3G	-3.19	1.48	1.56
3	H	1001	GNP	PG-O3G	-3.18	1.48	1.56
3	I	1001	GNP	PG-O3G	-3.18	1.48	1.56
5	L	1001	GDP	O4'-C1'	3.17	1.45	1.41
3	C	1001	GNP	PG-O3G	-3.16	1.48	1.56
3	G	1001	GNP	PG-O3G	-3.16	1.48	1.56
5	F	1001	GDP	O4'-C1'	3.16	1.45	1.41

Continued on next page...

Continued from previous page...

Mol	Chain	Res	Type	Atoms	Z	Observed(Å)	Ideal(Å)
3	B	1001	GNP	PG-O3G	-3.14	1.48	1.56
3	C	1001	GNP	PB-N3B	-3.07	1.55	1.63
3	I	1001	GNP	PB-N3B	-3.06	1.55	1.63
3	C	1001	GNP	PG-N3B	-2.92	1.55	1.63
3	I	1001	GNP	PG-N3B	-2.92	1.55	1.63
3	H	1001	GNP	C5-C4	-2.88	1.33	1.40
3	B	1001	GNP	C5-C4	-2.86	1.33	1.40
3	G	1001	GNP	PG-N3B	-2.80	1.56	1.63
5	J	1001	GDP	C2'-C1'	-2.79	1.49	1.53
3	C	1001	GNP	C5-C4	-2.79	1.33	1.40
3	I	1001	GNP	C5-C4	-2.78	1.33	1.40
5	D	1001	GDP	C2'-C1'	-2.76	1.49	1.53
3	A	1001	GNP	PG-N3B	-2.75	1.56	1.63
3	A	1001	GNP	C5-C4	-2.72	1.33	1.40
3	G	1001	GNP	C5-C4	-2.71	1.33	1.40
3	B	1001	GNP	C2-N1	2.65	1.40	1.35
3	H	1001	GNP	C2-N1	2.64	1.40	1.35
3	G	1001	GNP	C2-N1	2.56	1.40	1.35
3	C	1001	GNP	C2-N1	2.56	1.39	1.35
3	A	1001	GNP	C2-N1	2.55	1.39	1.35
3	I	1001	GNP	C2-N1	2.54	1.39	1.35
3	A	1001	GNP	O4'-C1'	2.50	1.44	1.41
3	G	1001	GNP	O4'-C1'	2.47	1.44	1.41
3	C	1001	GNP	O4'-C4'	2.15	1.49	1.45
3	I	1001	GNP	O4'-C4'	2.12	1.49	1.45
5	D	1001	GDP	O4'-C4'	2.05	1.49	1.45
5	J	1001	GDP	O4'-C4'	2.02	1.49	1.45
3	A	1001	GNP	C2'-C1'	-2.00	1.50	1.53

All (82) bond angle outliers are listed below:

Mol	Chain	Res	Type	Atoms	Z	Observed(°)	Ideal(°)
3	C	1001	GNP	N3-C2-N1	-6.09	119.10	127.22
3	B	1001	GNP	N3-C2-N1	-6.07	119.12	127.22
3	I	1001	GNP	N3-C2-N1	-6.07	119.12	127.22
3	H	1001	GNP	N3-C2-N1	-6.05	119.15	127.22
3	G	1001	GNP	N3-C2-N1	-5.97	119.26	127.22
3	A	1001	GNP	N3-C2-N1	-5.96	119.27	127.22
5	L	1001	GDP	O4'-C1'-C2'	-5.56	98.80	106.93
5	F	1001	GDP	O4'-C1'-C2'	-5.52	98.86	106.93
3	G	1001	GNP	PB-O3A-PA	-4.99	115.03	132.62
3	A	1001	GNP	PB-O3A-PA	-4.99	115.06	132.62

Continued on next page...

Continued from previous page...

Mol	Chain	Res	Type	Atoms	Z	Observed(°)	Ideal(°)
5	J	1001	GDP	O4'-C1'-C2'	-4.89	99.78	106.93
5	D	1001	GDP	O4'-C1'-C2'	-4.87	99.81	106.93
3	C	1001	GNP	C2-N3-C4	4.77	120.81	115.36
3	I	1001	GNP	C2-N3-C4	4.74	120.77	115.36
3	B	1001	GNP	PB-O3A-PA	-4.57	116.53	132.62
3	H	1001	GNP	PB-O3A-PA	-4.56	116.56	132.62
3	G	1001	GNP	C2-N3-C4	4.42	120.40	115.36
3	G	1001	GNP	O4'-C1'-C2'	-4.41	100.48	106.93
3	A	1001	GNP	C2-N3-C4	4.41	120.39	115.36
3	A	1001	GNP	O4'-C1'-C2'	-4.41	100.48	106.93
5	E	1001	GDP	PA-O3A-PB	-4.39	117.76	132.83
3	H	1001	GNP	C2-N3-C4	4.38	120.36	115.36
5	K	1001	GDP	PA-O3A-PB	-4.36	117.87	132.83
3	B	1001	GNP	C2-N3-C4	4.35	120.33	115.36
3	C	1001	GNP	PB-O3A-PA	-3.89	118.93	132.62
3	I	1001	GNP	PB-O3A-PA	-3.88	118.95	132.62
5	J	1001	GDP	C2-N1-C6	-3.63	118.41	125.10
5	J	1001	GDP	PA-O3A-PB	-3.62	120.42	132.83
5	D	1001	GDP	C2-N1-C6	-3.61	118.45	125.10
5	D	1001	GDP	PA-O3A-PB	-3.61	120.45	132.83
5	L	1001	GDP	C2-N1-C6	-3.59	118.49	125.10
5	F	1001	GDP	C2-N1-C6	-3.59	118.49	125.10
5	K	1001	GDP	C2-N1-C6	-3.53	118.60	125.10
5	E	1001	GDP	C2-N1-C6	-3.53	118.60	125.10
5	L	1001	GDP	PA-O3A-PB	-3.40	121.15	132.83
5	F	1001	GDP	PA-O3A-PB	-3.40	121.16	132.83
3	C	1001	GNP	O4'-C1'-C2'	-3.13	102.36	106.93
3	I	1001	GNP	O4'-C1'-C2'	-3.13	102.36	106.93
5	E	1001	GDP	C5-C6-N1	3.09	119.41	113.95
5	F	1001	GDP	C5-C6-N1	3.09	119.40	113.95
5	K	1001	GDP	C5-C6-N1	3.08	119.39	113.95
5	L	1001	GDP	C5-C6-N1	3.05	119.34	113.95
3	A	1001	GNP	C5-C6-N1	-3.02	119.30	123.43
3	G	1001	GNP	C5-C6-N1	-3.01	119.32	123.43
5	D	1001	GDP	C5-C6-N1	2.99	119.24	113.95
5	J	1001	GDP	C5-C6-N1	2.99	119.24	113.95
3	C	1001	GNP	C5-C6-N1	-2.96	119.39	123.43
3	H	1001	GNP	C5-C6-N1	-2.94	119.41	123.43
3	B	1001	GNP	C5-C6-N1	-2.93	119.43	123.43
3	I	1001	GNP	C5-C6-N1	-2.90	119.46	123.43
5	E	1001	GDP	C8-N7-C5	2.68	108.09	102.99
3	B	1001	GNP	N2-C2-N1	2.67	121.40	117.25

Continued on next page...

Continued from previous page...

Mol	Chain	Res	Type	Atoms	Z	Observed(°)	Ideal(°)
5	K	1001	GDP	C8-N7-C5	2.66	108.07	102.99
3	H	1001	GNP	N2-C2-N1	2.63	121.34	117.25
5	F	1001	GDP	C8-N7-C5	2.63	108.00	102.99
5	L	1001	GDP	C8-N7-C5	2.62	107.98	102.99
3	A	1001	GNP	O1G-PG-N3B	-2.61	107.93	111.77
3	I	1001	GNP	N2-C2-N1	2.58	121.27	117.25
3	G	1001	GNP	O1G-PG-N3B	-2.58	107.97	111.77
3	I	1001	GNP	O5'-C5'-C4'	2.58	117.87	108.99
3	C	1001	GNP	O5'-C5'-C4'	2.57	117.85	108.99
3	C	1001	GNP	N2-C2-N1	2.56	121.24	117.25
5	E	1001	GDP	O4'-C1'-C2'	-2.51	103.26	106.93
5	K	1001	GDP	O4'-C1'-C2'	-2.50	103.27	106.93
5	K	1001	GDP	N1-C2-N3	-2.45	118.73	123.32
5	D	1001	GDP	C8-N7-C5	2.45	107.66	102.99
5	E	1001	GDP	N1-C2-N3	-2.45	118.75	123.32
5	J	1001	GDP	C8-N7-C5	2.43	107.62	102.99
5	K	1001	GDP	N2-C2-N1	2.42	121.87	116.71
3	I	1001	GNP	O1G-PG-N3B	-2.42	108.20	111.77
3	C	1001	GNP	O1G-PG-N3B	-2.42	108.21	111.77
5	E	1001	GDP	N2-C2-N1	2.40	121.83	116.71
3	A	1001	GNP	N2-C2-N1	2.33	120.88	117.25
3	G	1001	GNP	N2-C2-N1	2.33	120.87	117.25
3	H	1001	GNP	O3G-PG-O1G	-2.31	107.66	113.45
3	B	1001	GNP	O3G-PG-O1G	-2.30	107.67	113.45
5	F	1001	GDP	N1-C2-N3	-2.29	119.04	123.32
5	L	1001	GDP	N1-C2-N3	-2.28	119.06	123.32
3	B	1001	GNP	O4'-C1'-C2'	-2.18	103.74	106.93
3	H	1001	GNP	O4'-C1'-C2'	-2.18	103.74	106.93
3	G	1001	GNP	O2B-PB-O3A	2.11	111.69	104.64
3	A	1001	GNP	O2B-PB-O3A	2.11	111.69	104.64

There are no chirality outliers.

All (38) torsion outliers are listed below:

Mol	Chain	Res	Type	Atoms
3	A	1001	GNP	PG-N3B-PB-O1B
3	A	1001	GNP	PG-N3B-PB-O3A
3	A	1001	GNP	PA-O3A-PB-O1B
3	A	1001	GNP	PA-O3A-PB-O2B
3	B	1001	GNP	PB-N3B-PG-O1G
3	B	1001	GNP	PG-N3B-PB-O1B
3	B	1001	GNP	PA-O3A-PB-O1B

Continued on next page...

Continued from previous page...

Mol	Chain	Res	Type	Atoms
3	C	1001	GNP	PB-N3B-PG-O1G
3	C	1001	GNP	PG-N3B-PB-O1B
3	C	1001	GNP	PA-O3A-PB-O1B
3	C	1001	GNP	PA-O3A-PB-O2B
3	G	1001	GNP	PG-N3B-PB-O1B
3	G	1001	GNP	PG-N3B-PB-O3A
3	G	1001	GNP	PA-O3A-PB-O1B
3	G	1001	GNP	PA-O3A-PB-O2B
3	H	1001	GNP	PB-N3B-PG-O1G
3	H	1001	GNP	PG-N3B-PB-O1B
3	H	1001	GNP	PA-O3A-PB-O1B
3	I	1001	GNP	PB-N3B-PG-O1G
3	I	1001	GNP	PG-N3B-PB-O1B
3	I	1001	GNP	PA-O3A-PB-O1B
3	I	1001	GNP	PA-O3A-PB-O2B
5	D	1001	GDP	C5'-O5'-PA-O2A
5	F	1001	GDP	C5'-O5'-PA-O3A
5	F	1001	GDP	C5'-O5'-PA-O1A
5	J	1001	GDP	C5'-O5'-PA-O2A
5	L	1001	GDP	C5'-O5'-PA-O3A
5	L	1001	GDP	C5'-O5'-PA-O1A
5	D	1001	GDP	C5'-O5'-PA-O3A
5	J	1001	GDP	C5'-O5'-PA-O3A
5	D	1001	GDP	C5'-O5'-PA-O1A
5	F	1001	GDP	C5'-O5'-PA-O2A
5	J	1001	GDP	C5'-O5'-PA-O1A
5	L	1001	GDP	C5'-O5'-PA-O2A
5	F	1001	GDP	PA-O3A-PB-O1B
5	L	1001	GDP	PA-O3A-PB-O1B
5	D	1001	GDP	PA-O3A-PB-O2B
5	J	1001	GDP	PA-O3A-PB-O2B

There are no ring outliers.

10 monomers are involved in 23 short contacts:

Mol	Chain	Res	Type	Clashes	Symm-Clashes
3	C	1001	GNP	2	0
3	I	1001	GNP	1	0
5	J	1001	GDP	2	0
3	G	1001	GNP	3	0
3	H	1001	GNP	4	0
5	K	1001	GDP	1	0

Continued on next page...

Continued from previous page...

Mol	Chain	Res	Type	Clashes	Symm-Clashes
5	D	1001	GDP	2	0
3	A	1001	GNP	4	0
5	F	1001	GDP	1	0
3	B	1001	GNP	3	0

The following is a two-dimensional graphical depiction of Mogul quality analysis of bond lengths, bond angles, torsion angles, and ring geometry for all instances of the Ligand of Interest. In addition, ligands with molecular weight > 250 and outliers as shown on the validation Tables will also be included. For torsion angles, if less than 5% of the Mogul distribution of torsion angles is within 10 degrees of the torsion angle in question, then that torsion angle is considered an outlier. Any bond that is central to one or more torsion angles identified as an outlier by Mogul will be highlighted in the graph. For rings, the root-mean-square deviation (RMSD) between the ring in question and similar rings identified by Mogul is calculated over all ring torsion angles. If the average RMSD is greater than 60 degrees and the minimal RMSD between the ring in question and any Mogul-identified rings is also greater than 60 degrees, then that ring is considered an outlier. The outliers are highlighted in purple. The color gray indicates Mogul did not find sufficient equivalents in the CSD to analyse the geometry.

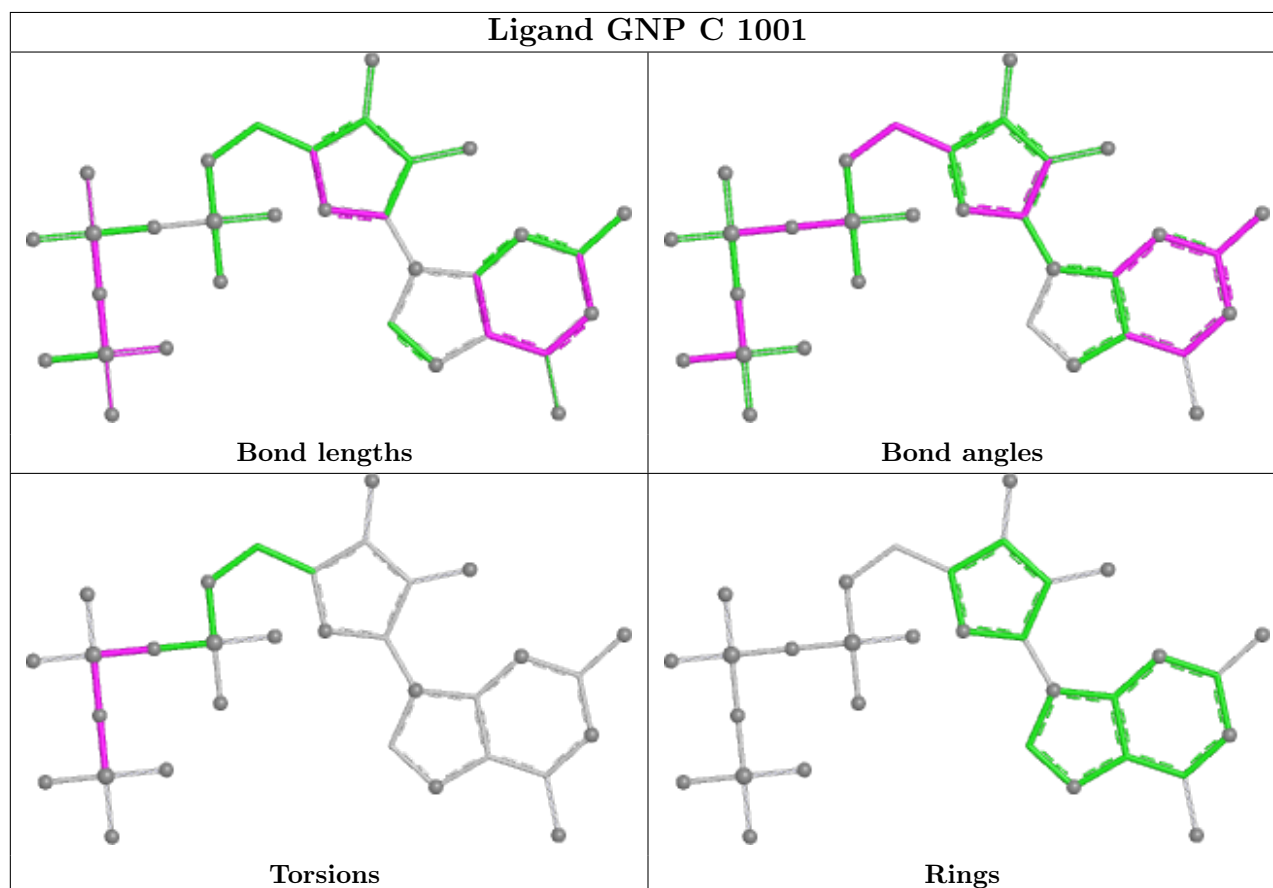

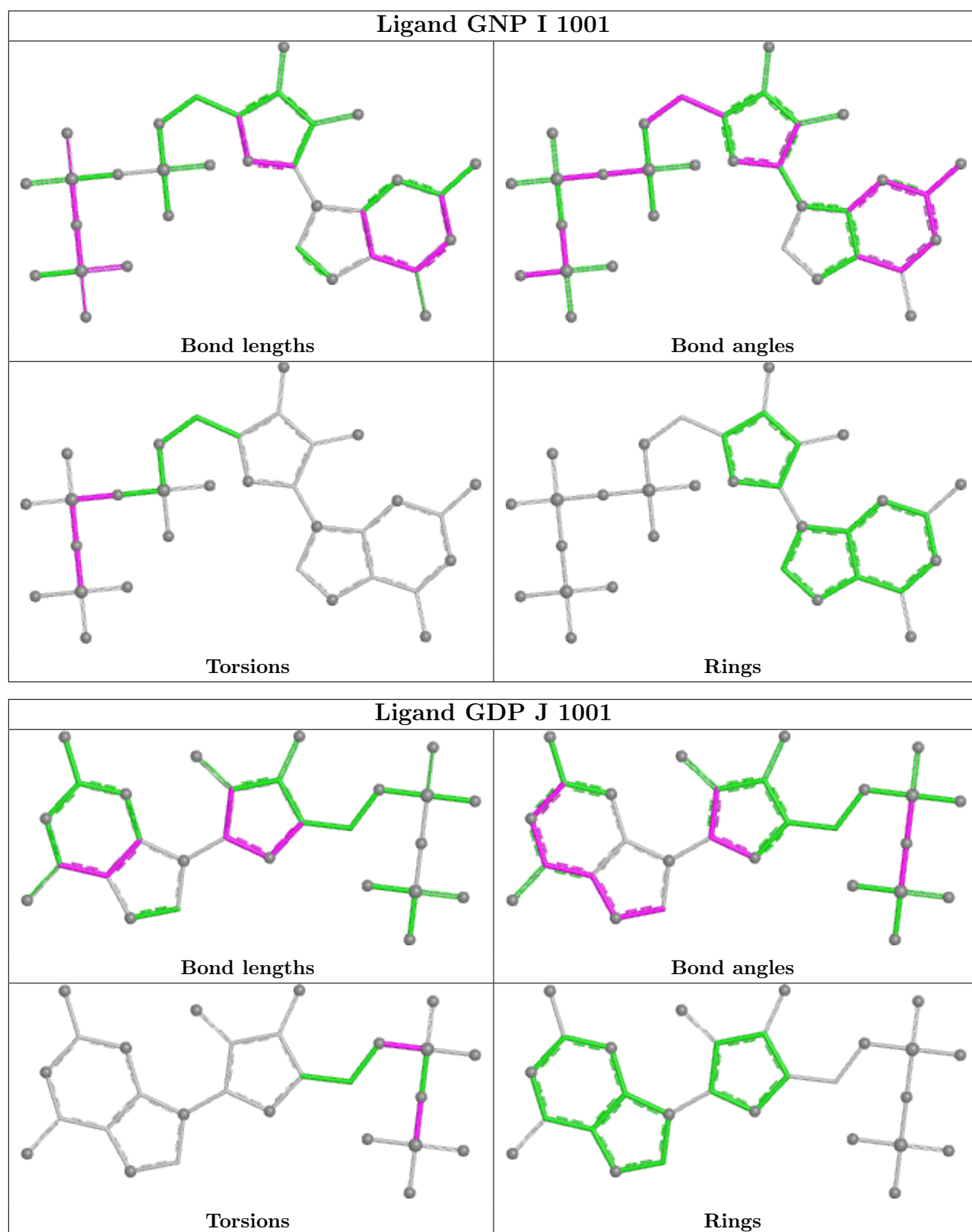

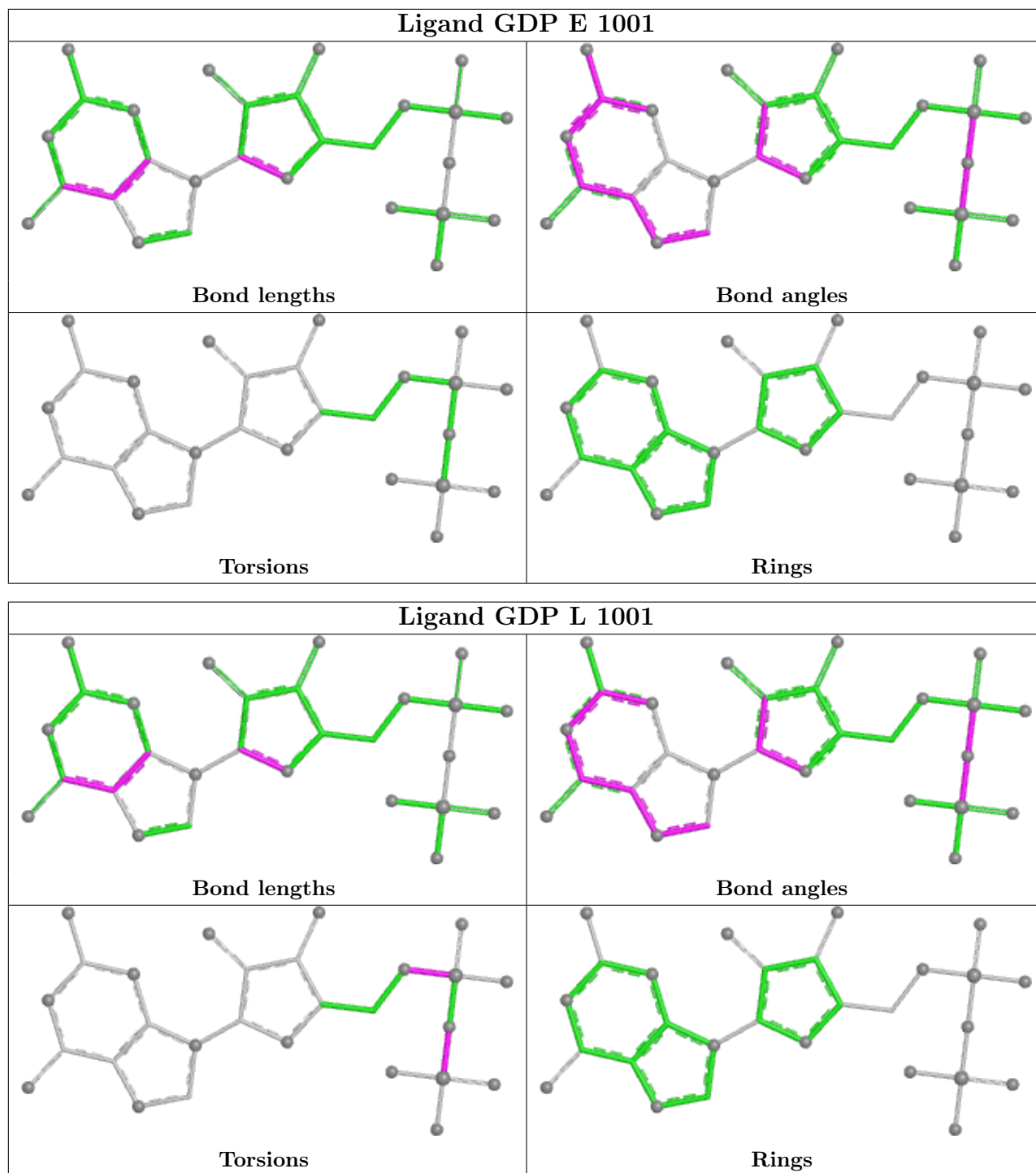

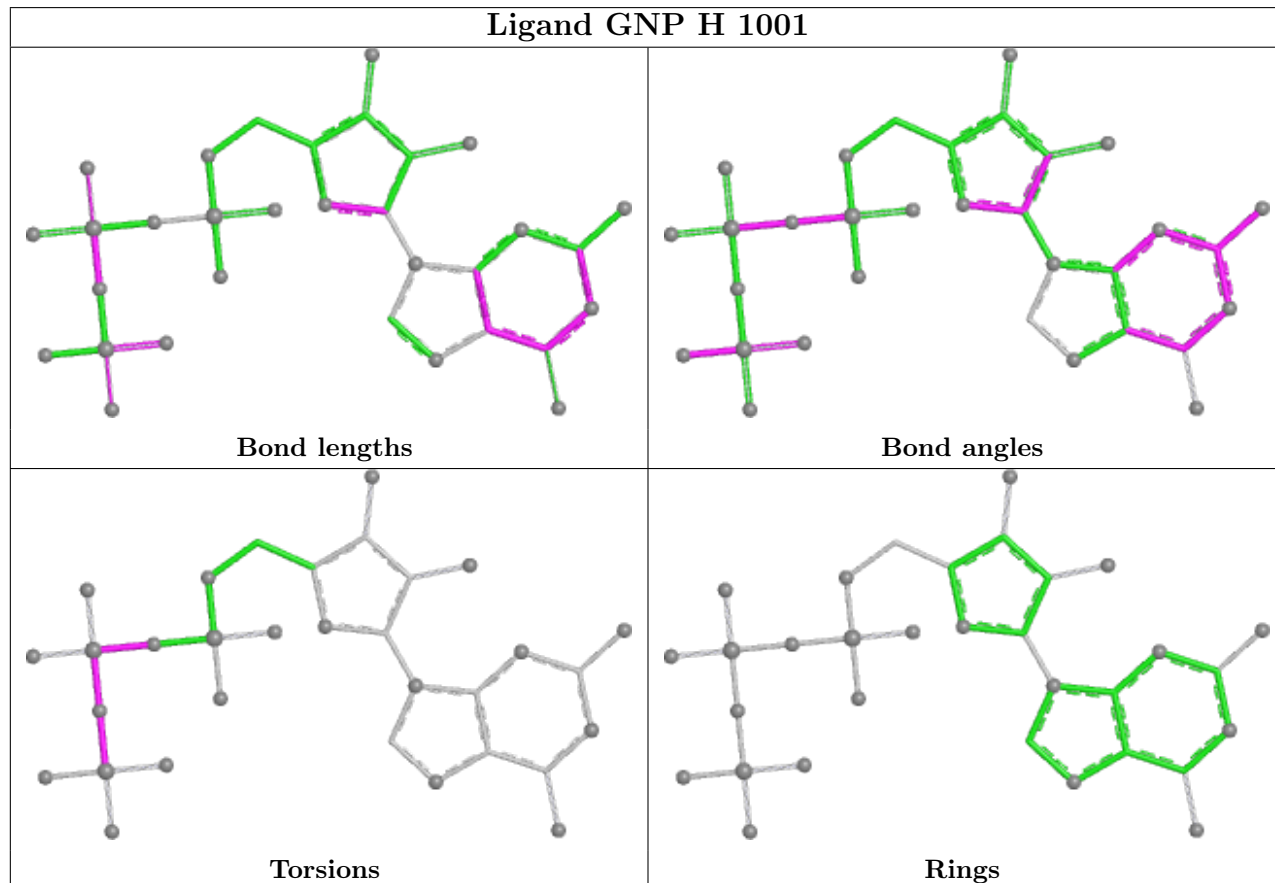
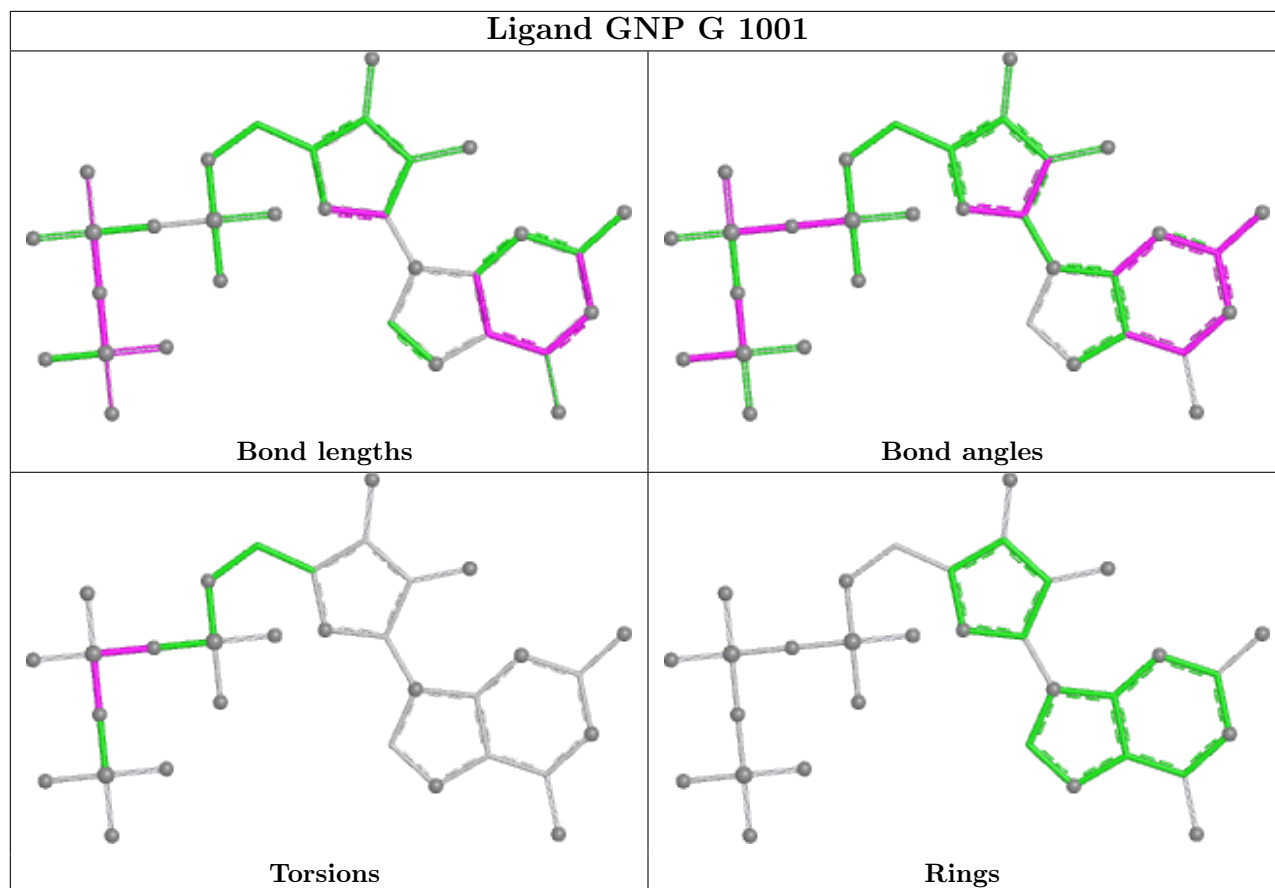

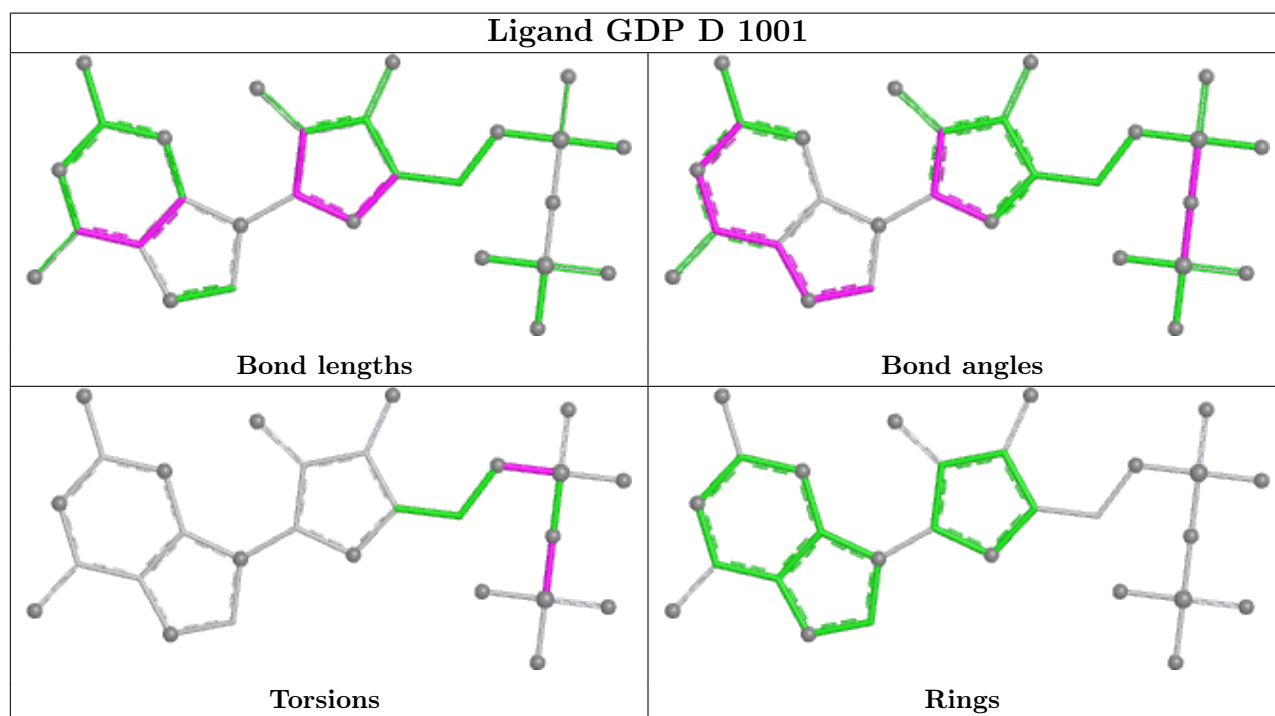
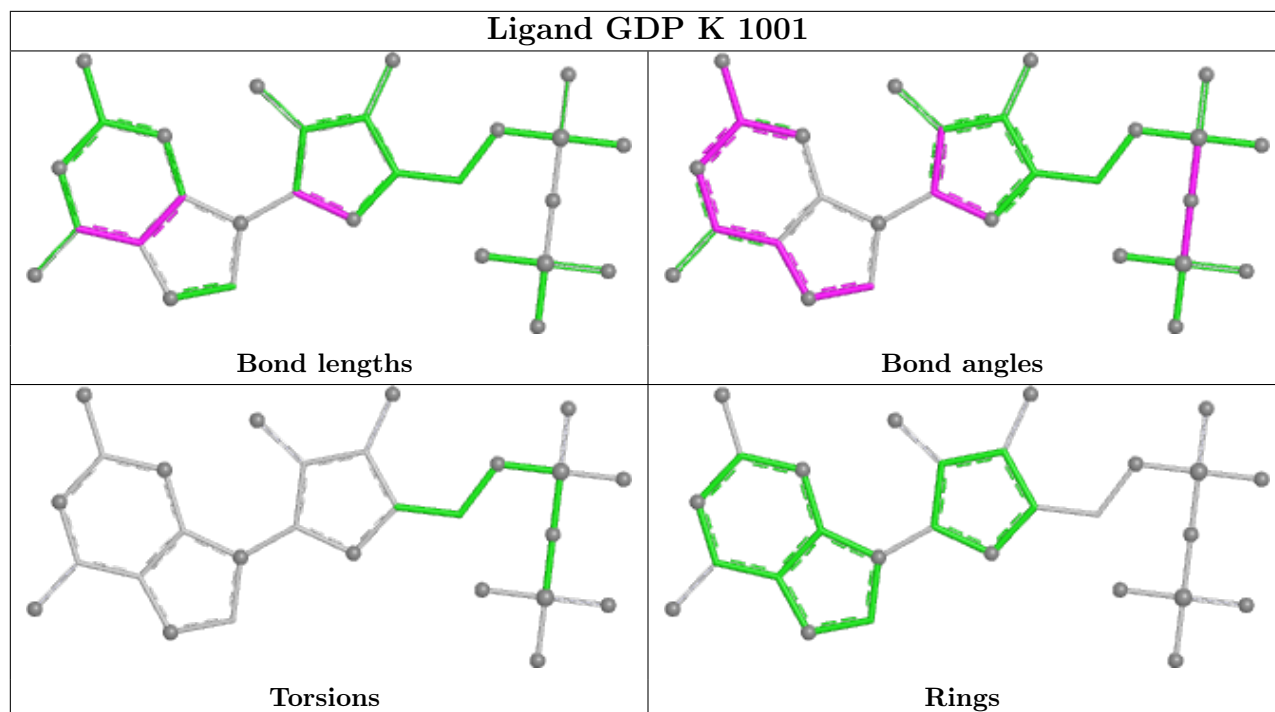

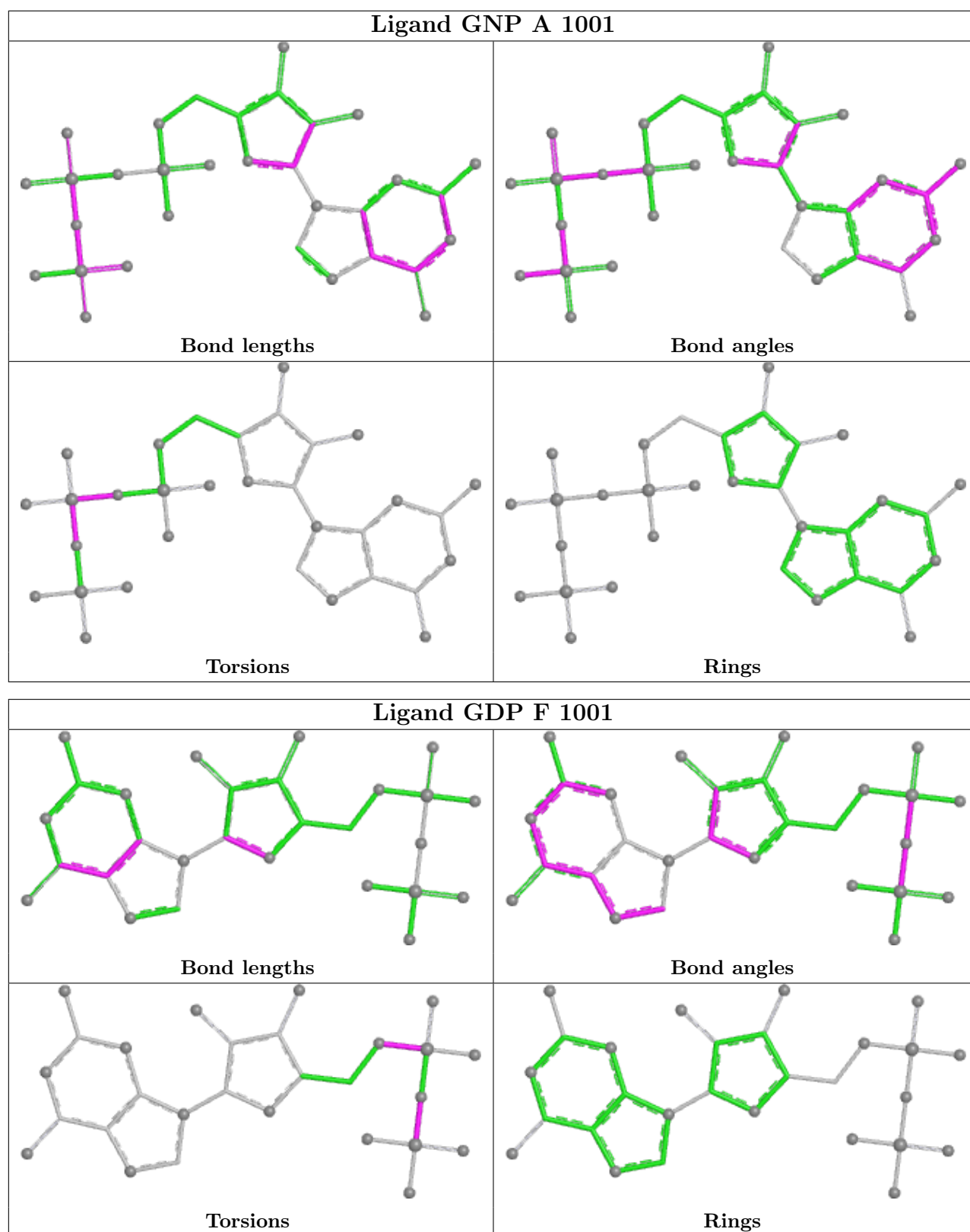

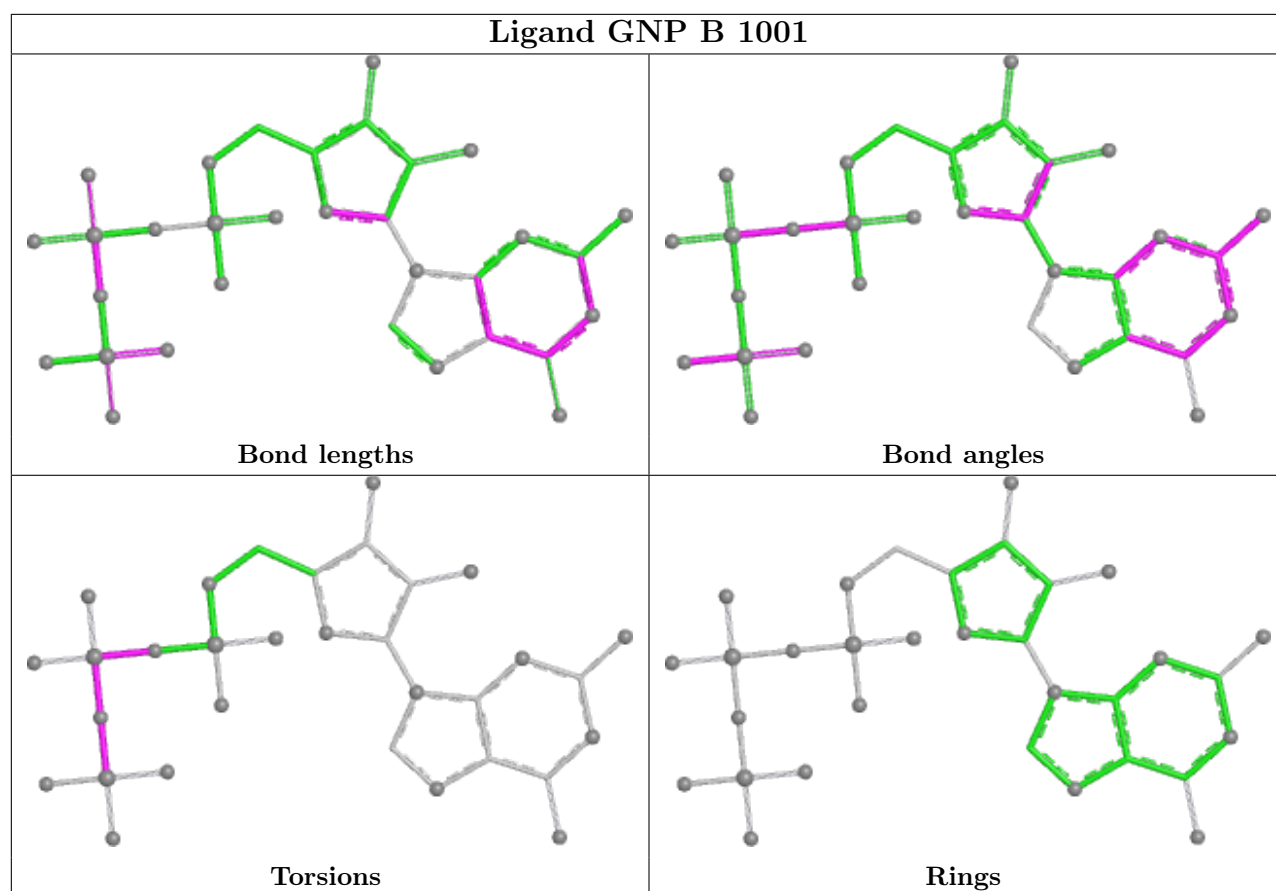

5.7 Other polymers [i](#)

There are no such residues in this entry.

5.8 Polymer linkage issues [i](#)

There are no chain breaks in this entry.

6 Map visualisation [i](#)

This section contains visualisations of the EMDB entry EMD-0313. These allow visual inspection of the internal detail of the map and identification of artifacts.

Images derived from a raw map, generated by summing the deposited half-maps, are presented below the corresponding image components of the primary map to allow further visual inspection and comparison with those of the primary map.

6.1 Orthogonal projections [i](#)

6.1.1 Primary map

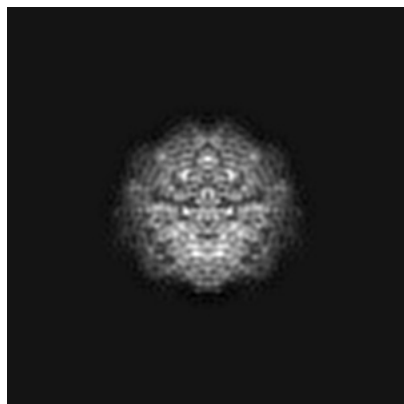

X

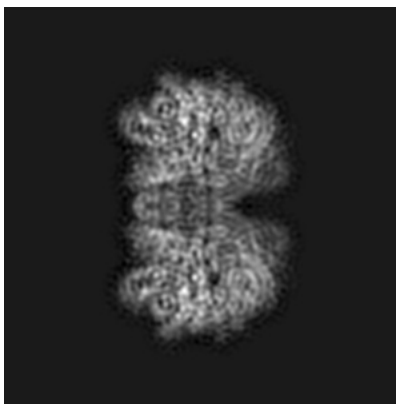

Y

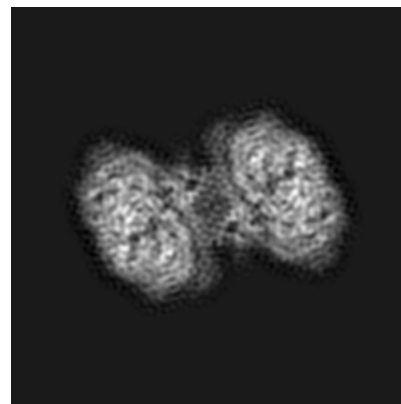

Z

6.1.2 Raw map

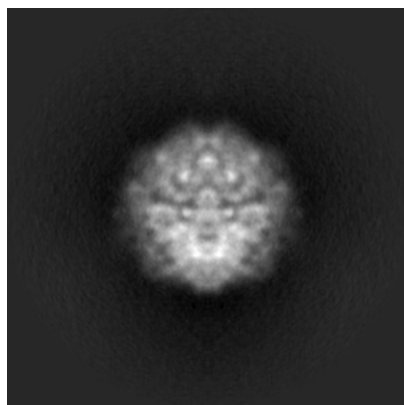

X

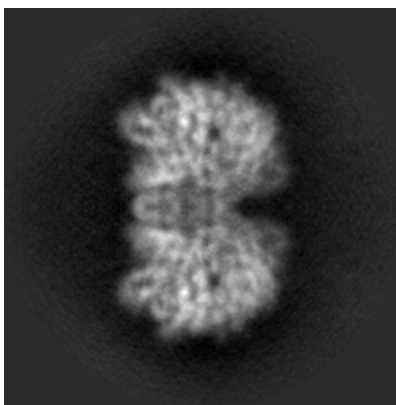

Y

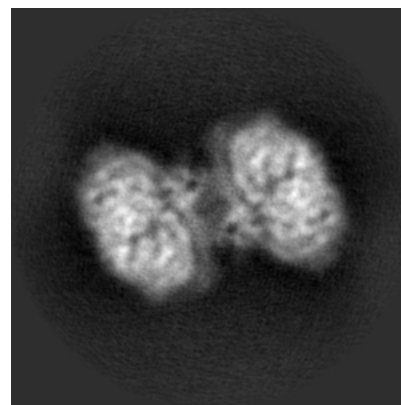

Z

The images above show the map projected in three orthogonal directions.

6.2 Central slices [i](#)

6.2.1 Primary map



X Index: 120

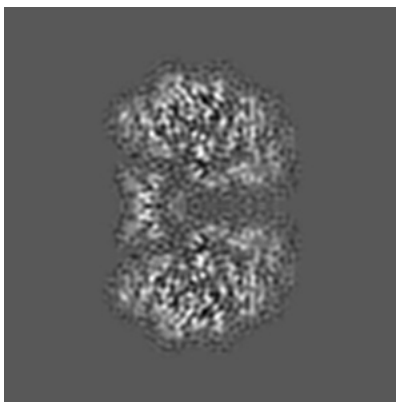

Y Index: 120

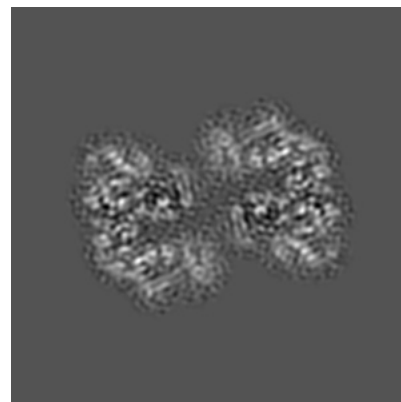

Z Index: 120

6.2.2 Raw map

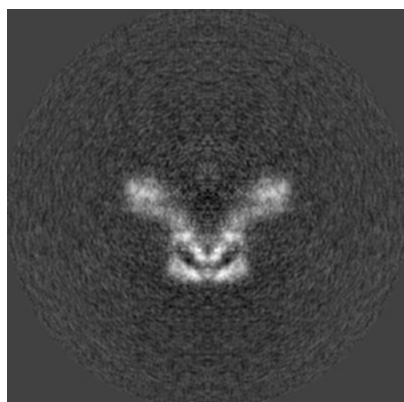

X Index: 120

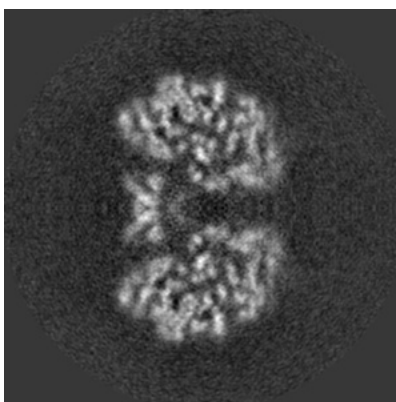

Y Index: 120

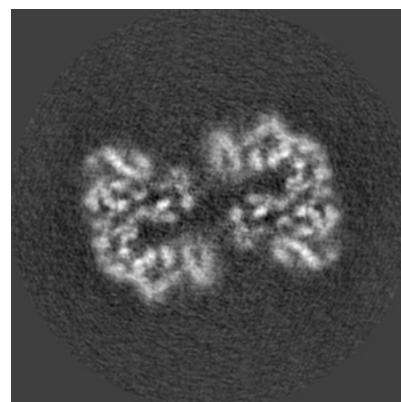

Z Index: 120

The images above show central slices of the map in three orthogonal directions.

6.3 Largest variance slices [i](#)

6.3.1 Primary map

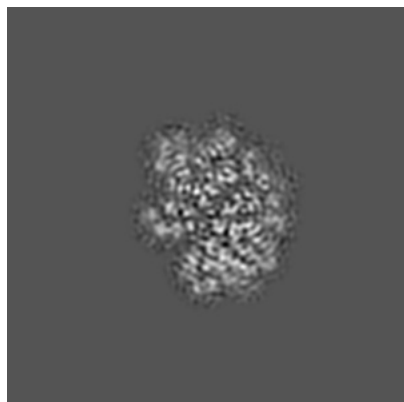

X Index: 171

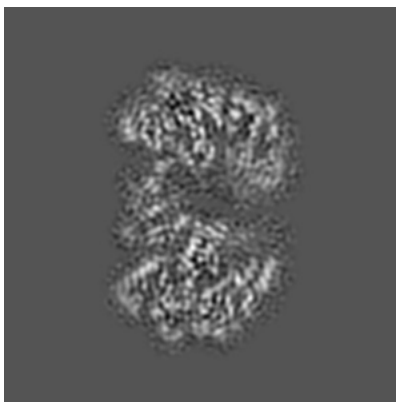

Y Index: 124

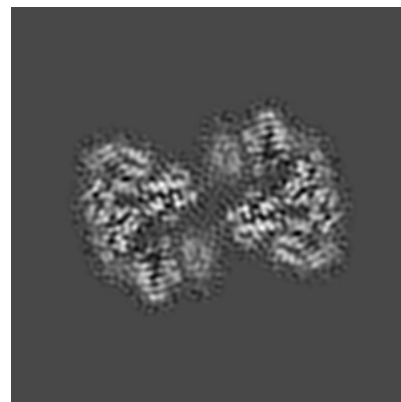

Z Index: 117

6.3.2 Raw map

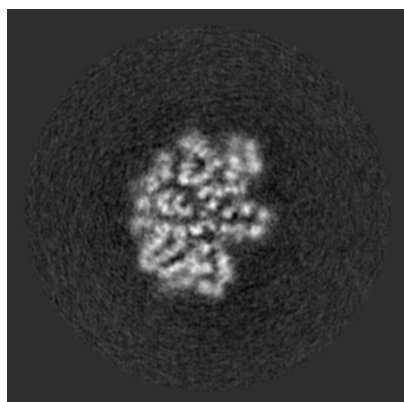

X Index: 68

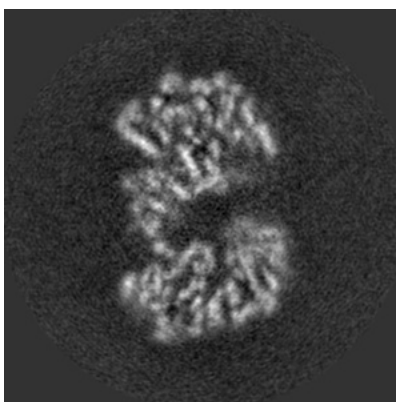

Y Index: 115

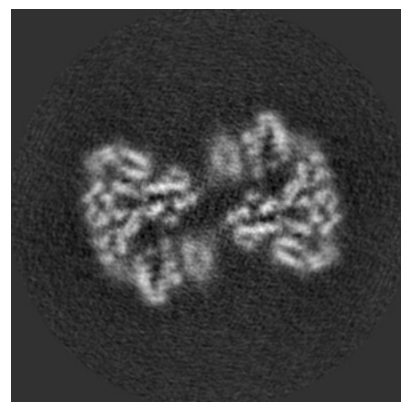

Z Index: 117

The images above show the largest variance slices of the map in three orthogonal directions.

6.4 Orthogonal surface views [i](#)

6.4.1 Primary map

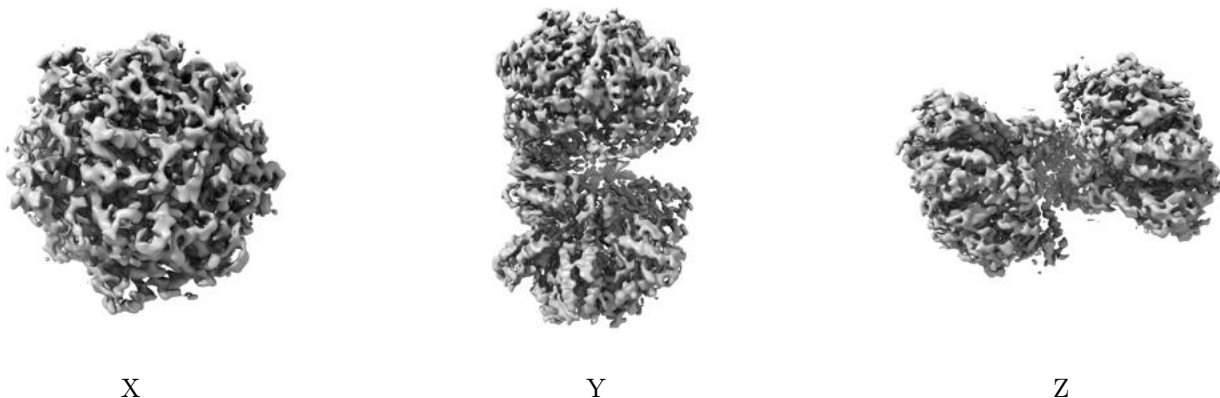

The images above show the 3D surface view of the map at the recommended contour level 0.026. These images, in conjunction with the slice images, may facilitate assessment of whether an appropriate contour level has been provided.

6.4.2 Raw map

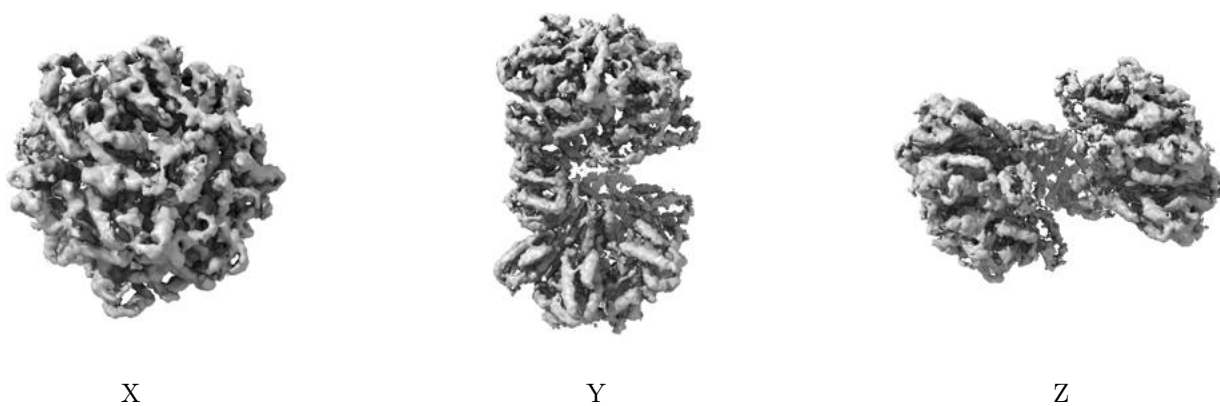

These images show the 3D surface of the raw map. The raw map's contour level was selected so that its surface encloses the same volume as the primary map does at its recommended contour level.

6.5 Mask visualisation [i](#)

This section shows the 3D surface view of the primary map at 50% transparency overlaid with the specified mask at 0% transparency

A mask typically either:

- Encompasses the whole structure
- Separates out a domain, a functional unit, a monomer or an area of interest from a larger structure

6.5.1 emd_0313_msk_1.map [i](#)

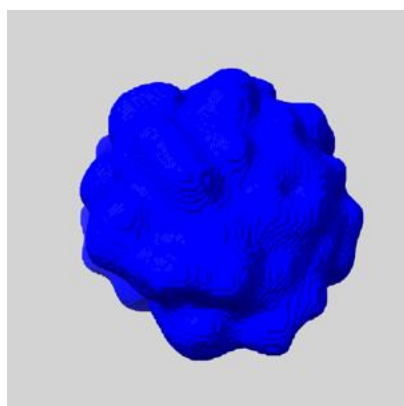

X

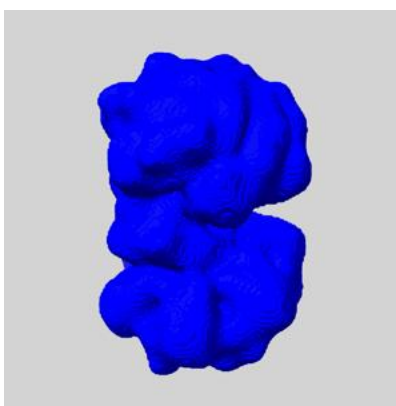

Y

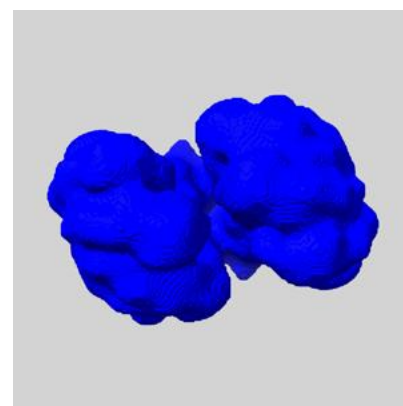

Z

7 Map analysis [i](#)

This section contains the results of statistical analysis of the map.

7.1 Map-value distribution [i](#)

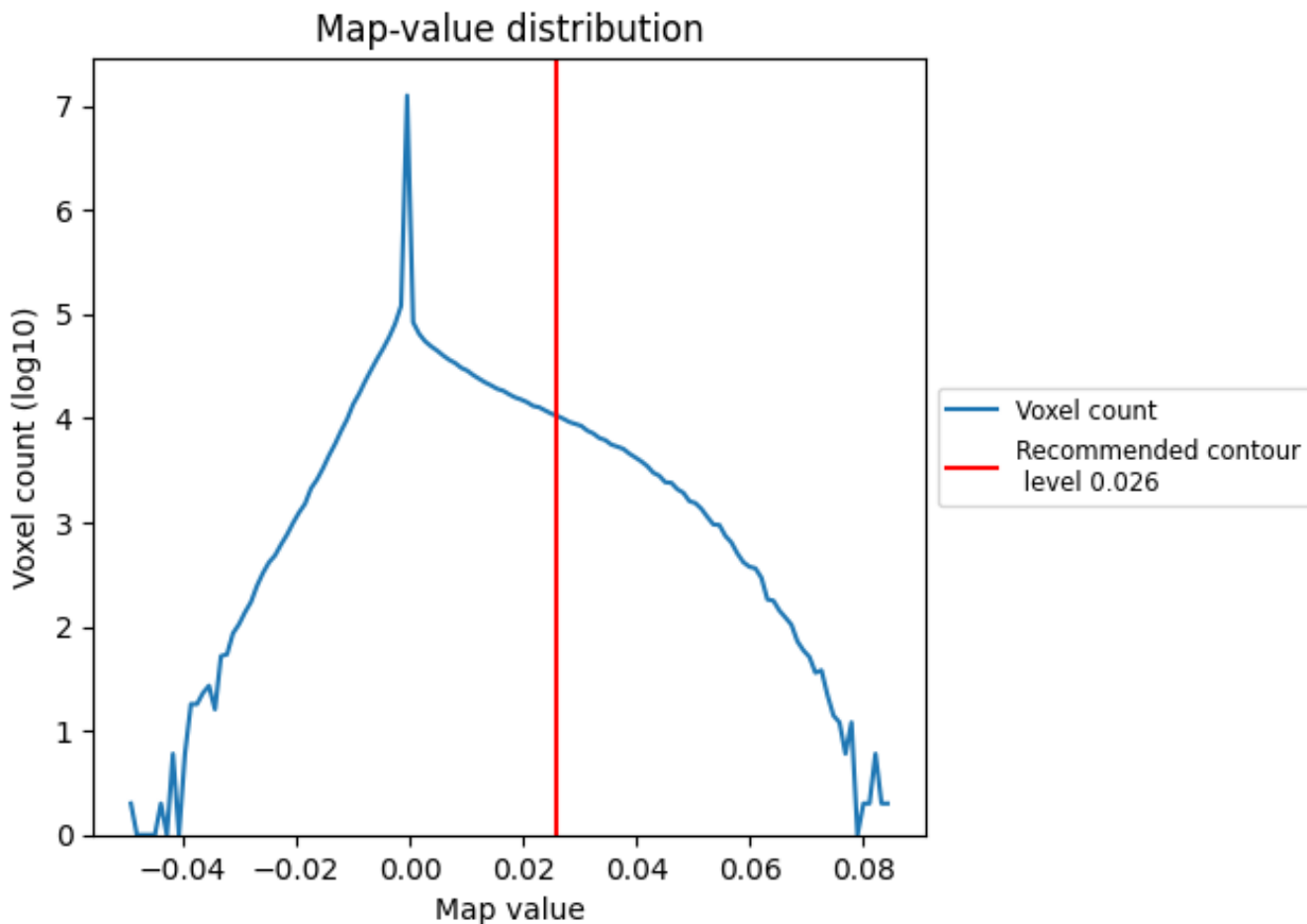

The map-value distribution is plotted in 128 intervals along the x-axis. The y-axis is logarithmic. A spike in this graph at zero usually indicates that the volume has been masked.

7.2 Volume estimate [\(i\)](#)

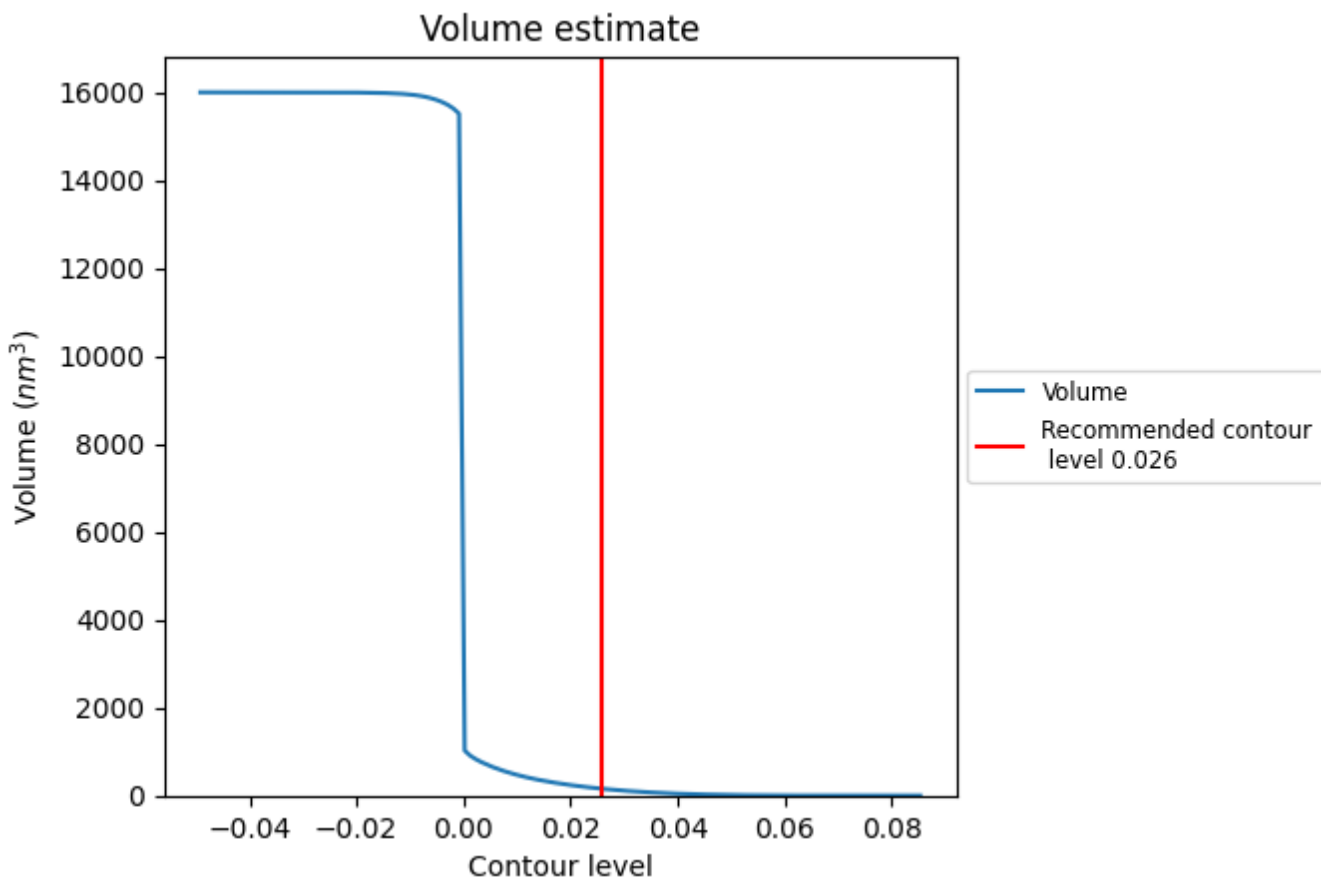

The volume at the recommended contour level is 154 nm³; this corresponds to an approximate mass of 139 kDa.

The volume estimate graph shows how the enclosed volume varies with the contour level. The recommended contour level is shown as a vertical line and the intersection between the line and the curve gives the volume of the enclosed surface at the given level.

7.3 Rotationally averaged power spectrum i

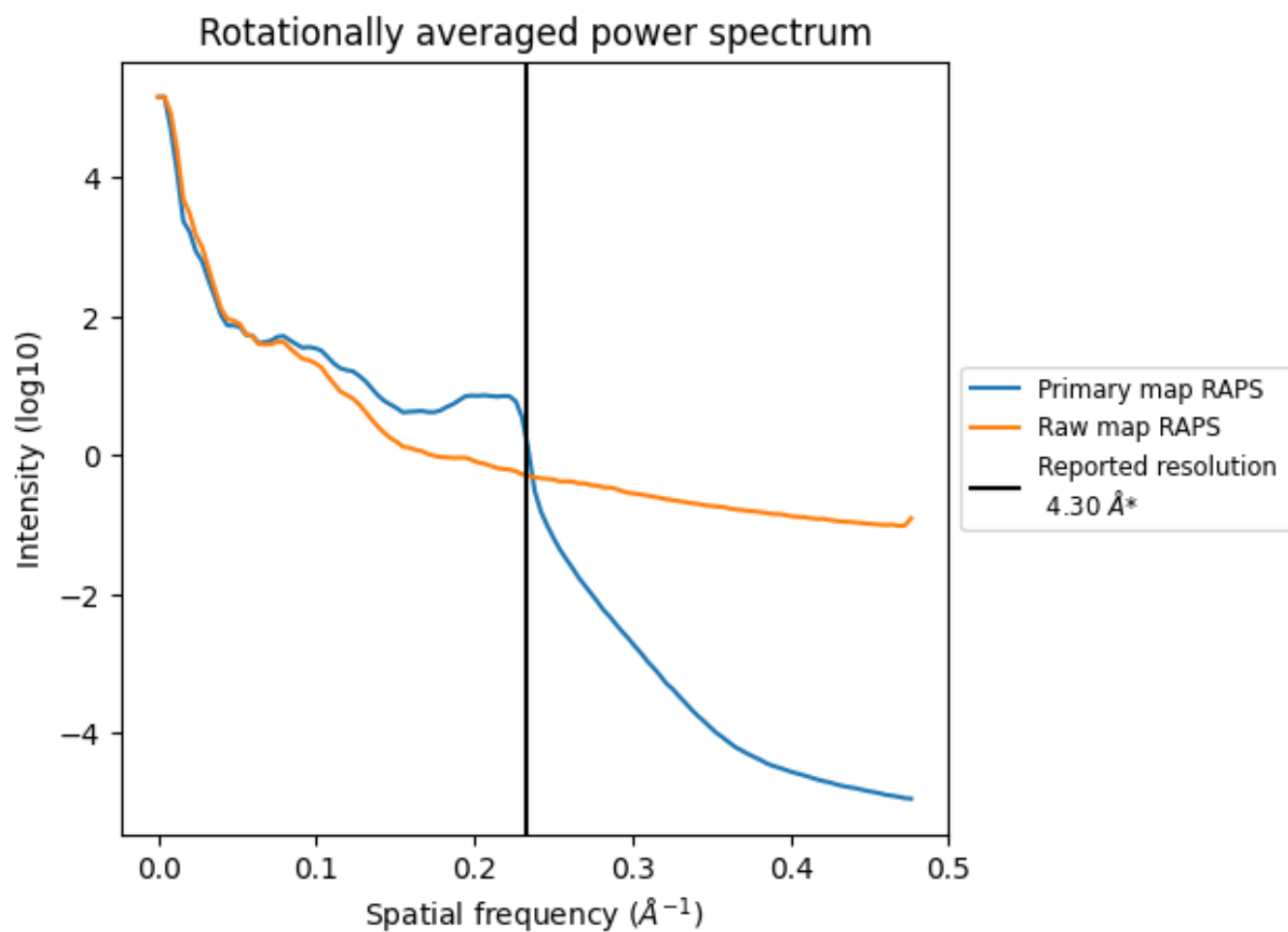

*Reported resolution corresponds to spatial frequency of 0.233 Å⁻¹

8 Fourier-Shell correlation [i](#)

Fourier-Shell Correlation (FSC) is the most commonly used method to estimate the resolution of single-particle and subtomogram-averaged maps. The shape of the curve depends on the imposed symmetry, mask and whether or not the two 3D reconstructions used were processed from a common reference. The reported resolution is shown as a black line. A curve is displayed for the half-bit criterion in addition to lines showing the 0.143 gold standard cut-off and 0.5 cut-off.

8.1 FSC [i](#)

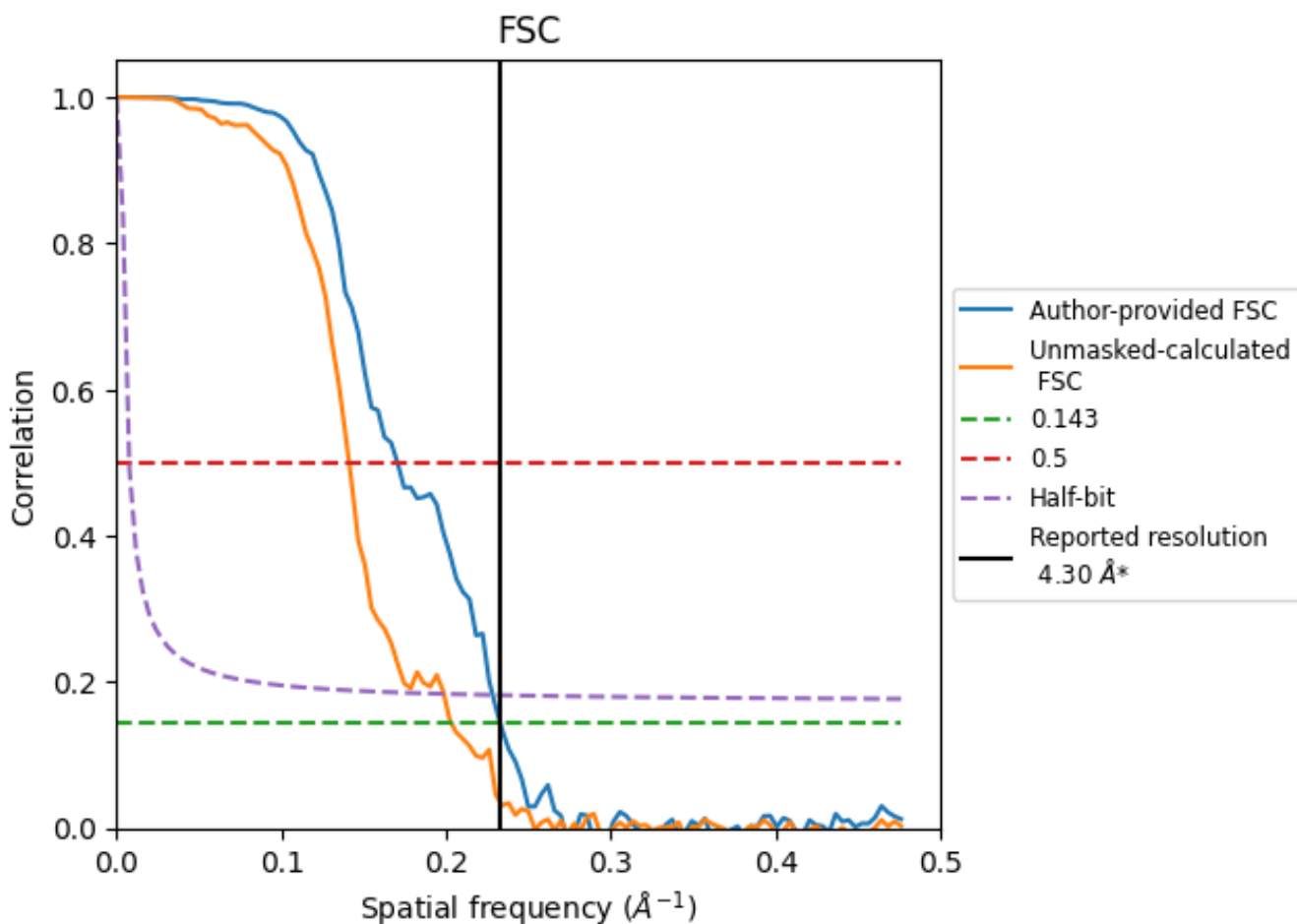

*Reported resolution corresponds to spatial frequency of 0.233\AA^{-1}

8.2 Resolution estimates [i](#)

Resolution estimate (Å)	Estimation criterion (FSC cut-off)		
	0.143	0.5	Half-bit
Reported by author	4.30	-	-
Author-provided FSC curve	4.29	5.86	4.38
Unmasked-calculated*	4.92	7.08	5.03

*Resolution estimate based on FSC curve calculated by comparison of deposited half-maps. The value from deposited half-maps intersecting FSC 0.143 CUT-OFF 4.92 differs from the reported value 4.3 by more than 10 %

9 Map-model fit [i](#)

This section contains information regarding the fit between EMDB map EMD-0313 and PDB model 6HZ7. Per-residue inclusion information can be found in section 3 on page 10.

9.1 Map-model overlay [i](#)

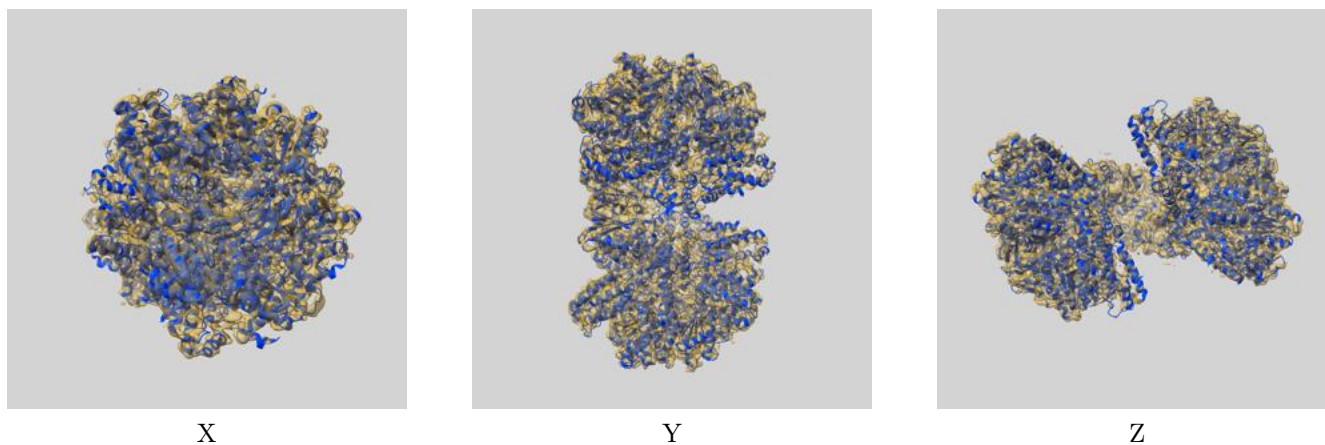

The images above show the 3D surface view of the map at the recommended contour level 0.026 at 50% transparency in yellow overlaid with a ribbon representation of the model coloured in blue. These images allow for the visual assessment of the quality of fit between the atomic model and the map.

9.2 Q-score mapped to coordinate model [i](#)

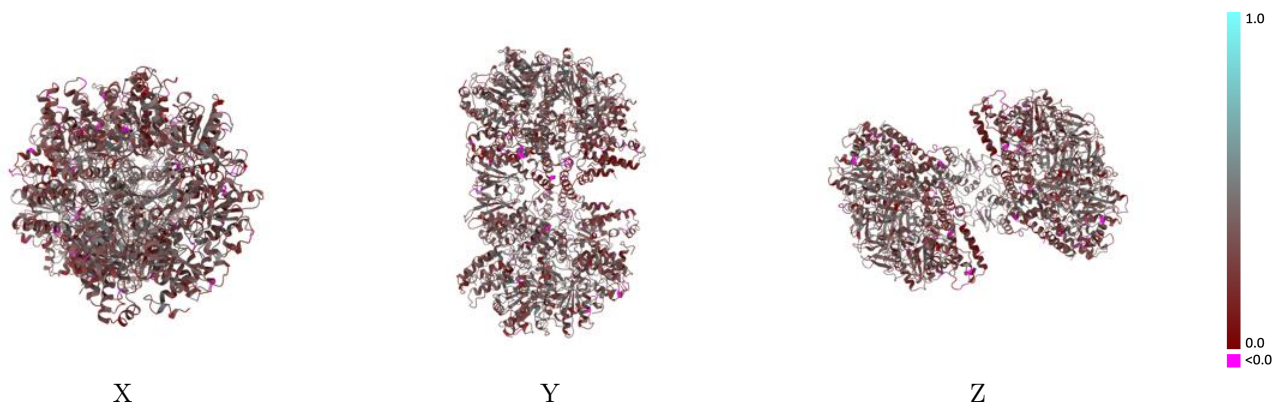

The images above show the model with each residue coloured according to its Q-score. This shows their resolvability in the map with higher Q-score values reflecting better resolvability. Please note: Q-score is calculating the resolvability of atoms, and thus high values are only expected at resolutions at which atoms can be resolved. Low Q-score values may therefore be expected for many entries.

9.3 Atom inclusion mapped to coordinate model [i](#)

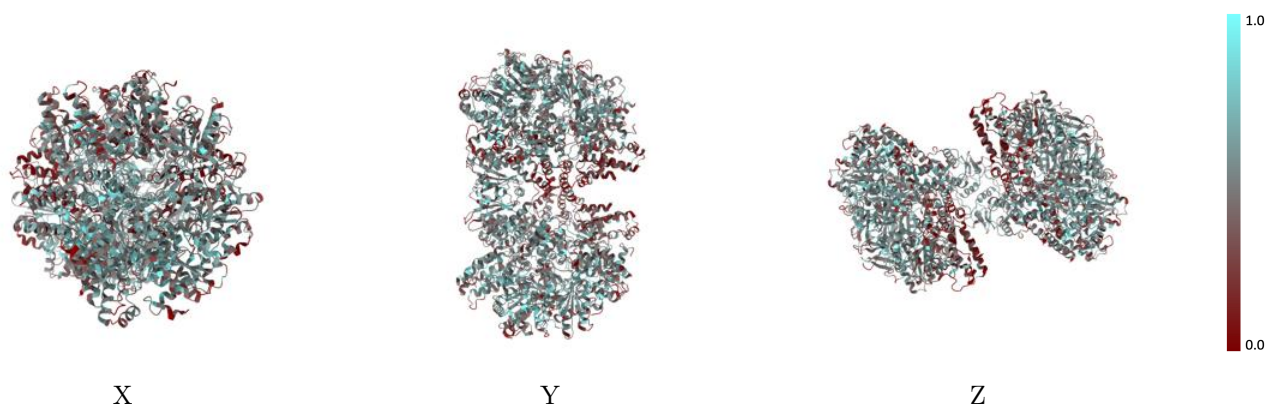

The images above show the model with each residue coloured according to its atom inclusion. This shows to what extent they are inside the map at the recommended contour level (0.026).



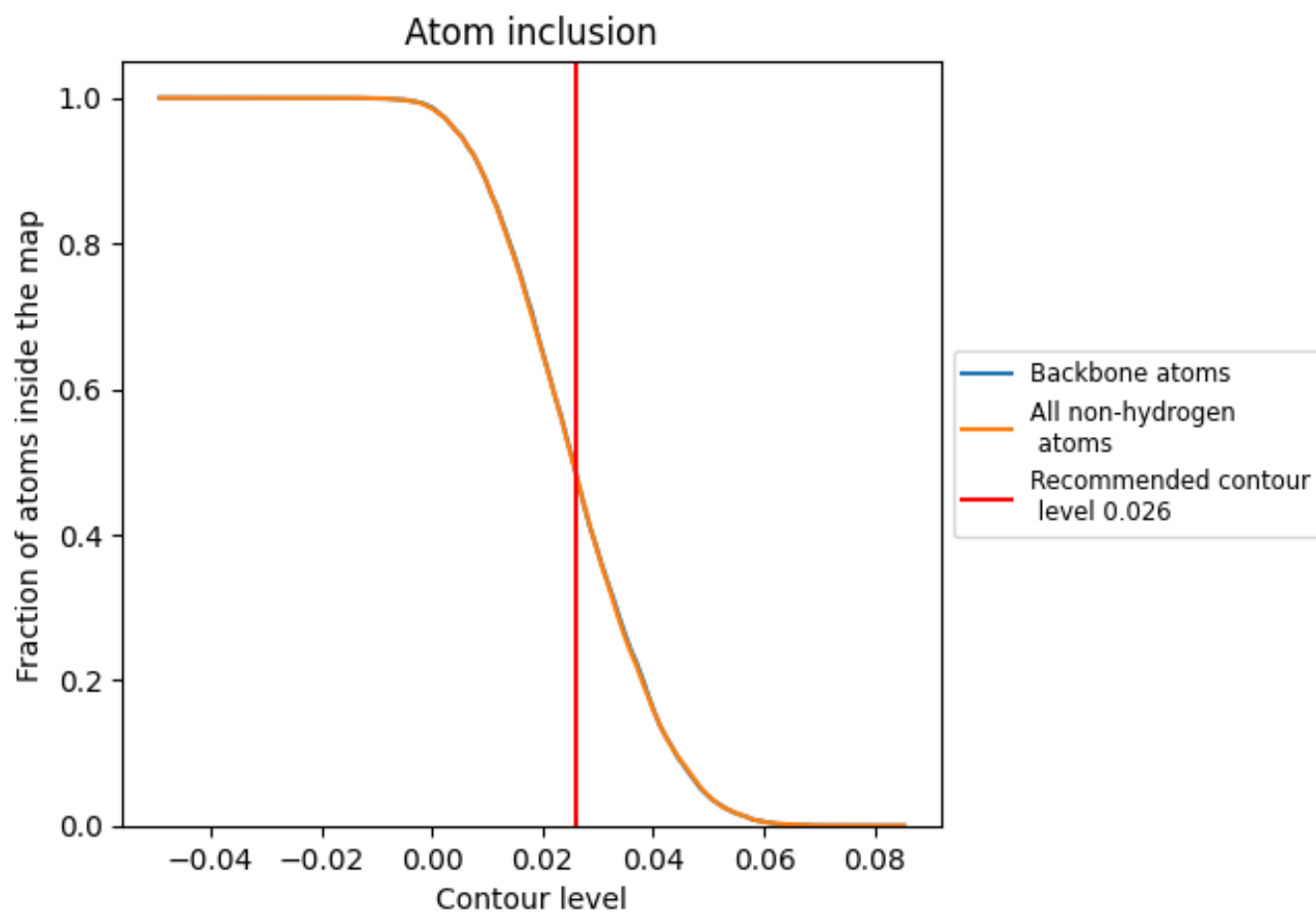



























9.4 Atom inclusion [i](#)



At the recommended contour level, 49% of all backbone atoms, 48% of all non-hydrogen atoms, are inside the map.

9.5 Map-model fit summary

The table lists the average atom inclusion at the recommended contour level (0.026) and Q-score for the entire model and for each chain.

Chain	Atom inclusion	Q-score
All	 0.4849	 0.3140
A	 0.4949	 0.3110
B	 0.5406	 0.3380
C	 0.5402	 0.3370
D	 0.5143	 0.3230
E	 0.4291	 0.2900
F	 0.3777	 0.2660
G	 0.4810	 0.2820
H	 0.5393	 0.3420
I	 0.5351	 0.3410
J	 0.5182	 0.3230
K	 0.4390	 0.2900
L	 0.3799	 0.2630
M	 0.5426	 0.3380
N	 0.5426	 0.3380

