



wwPDB EM Validation Summary Report ⓘ

Nov 28, 2022 – 12:23 PM JST

PDB ID : 8H0V
EMDB ID : EMD-34415
Title : RNA polymerase II transcribing a chromatosome (type I)
Authors : Hirano, R.; Ehara, H.; Tomoya, K.; Takizawa, Y.; Sekine, S.; Kurumizaka, H.
Deposited on : 2022-09-30
Resolution : 3.80 Å (reported)

This is a wwPDB EM Validation Summary Report for a publicly released PDB entry.

We welcome your comments at validation@mail.wwpdb.org

A user guide is available at

<https://www.wwpdb.org/validation/2017/EMValidationReportHelp>

with specific help available everywhere you see the ⓘ symbol.

The types of validation reports are described at

<http://www.wwpdb.org/validation/2017/FAQs#types>.

The following versions of software and data (see [references ⓘ](#)) were used in the production of this report:

EMDB validation analysis : 0.0.1.dev43
MolProbity : 4.02b-467
Percentile statistics : 20191225.v01 (using entries in the PDB archive December 25th 2019)
MapQ : 1.9.9
Ideal geometry (proteins) : Engh & Huber (2001)
Ideal geometry (DNA, RNA) : Parkinson et al. (1996)
Validation Pipeline (wwPDB-VP) : 2.31.3

1 Overall quality at a glance

The following experimental techniques were used to determine the structure:

ELECTRON MICROSCOPY

The reported resolution of this entry is 3.80 Å.

Percentile scores (ranging between 0-100) for global validation metrics of the entry are shown in the following graphic. The table shows the number of entries on which the scores are based.

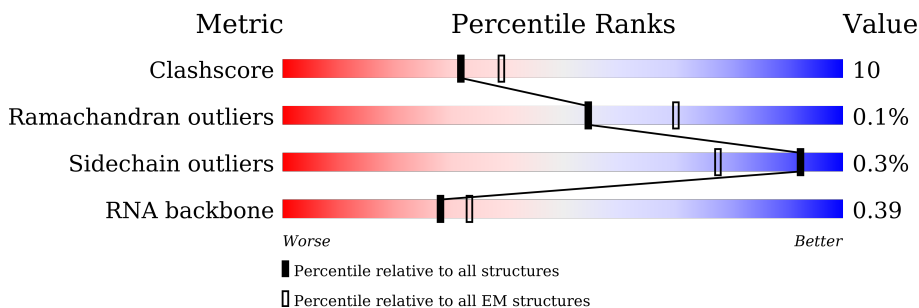

Metric	Whole archive (#Entries)	EM structures (#Entries)
Clashscore	158937	4297
Ramachandran outliers	154571	4023
Sidechain outliers	154315	3826
RNA backbone	4643	859

The table below summarises the geometric issues observed across the polymeric chains and their fit to the map. The red, orange, yellow and green segments of the bar indicate the fraction of residues that contain outliers for ≥ 3 , 2, 1 and 0 types of geometric quality criteria respectively. A grey segment represents the fraction of residues that are not modelled. The numeric value for each fraction is indicated below the corresponding segment, with a dot representing fractions $\leq 5\%$. The upper red bar (where present) indicates the fraction of residues that have poor fit to the EM map (all-atom inclusion $< 40\%$). The numeric value is given above the bar.

Mol	Chain	Length	Quality of chain
1	A	1743	
2	B	1227	
3	C	304	
4	D	186	
5	E	214	
6	F	155	
7	G	171	

Continued on next page...

Continued from previous page...

Mol	Chain	Length	Quality of chain
8	H	145	
9	I	115	
10	J	72	
11	K	118	
12	L	72	
13	P	14	
14	T	261	
15	N	261	
16	a	139	
16	e	139	
17	b	106	
17	f	106	
18	c	133	
18	g	133	
19	d	129	
19	h	129	
20	u	219	

2 Entry composition [i](#)

There are 22 unique types of molecules in this entry. The entry contains 46571 atoms, of which 0 are hydrogens and 0 are deuteriums.

In the tables below, the AltConf column contains the number of residues with at least one atom in alternate conformation and the Trace column contains the number of residues modelled with at most 2 atoms.

- Molecule 1 is a protein called DNA-directed RNA polymerase subunit.

Mol	Chain	Residues	Atoms					AltConf	Trace
			Total	C	N	O	S		
1	A	1412	11120	7015	1936	2099	70	0	0

- Molecule 2 is a protein called DNA-directed RNA polymerase subunit beta.

Mol	Chain	Residues	Atoms					AltConf	Trace
			Total	C	N	O	S		
2	B	1161	9261	5835	1636	1732	58	0	0

- Molecule 3 is a protein called RNA polymerase II third largest subunit B44, part of central core.

Mol	Chain	Residues	Atoms					AltConf	Trace
			Total	C	N	O	S		
3	C	263	2098	1319	354	413	12	0	0

- Molecule 4 is a protein called RNA polymerase II subunit B32.

Mol	Chain	Residues	Atoms					AltConf	Trace
			Total	C	N	O	S		
4	D	168	1314	812	237	263	2	0	0

- Molecule 5 is a protein called DNA-directed RNA polymerases I, II, and III subunit RPABC1.

Mol	Chain	Residues	Atoms					AltConf	Trace
			Total	C	N	O	S		
5	E	213	1740	1094	312	324	10	0	0

- Molecule 6 is a protein called RNA polymerase subunit ABC23, common to RNA polymerases I, II, and III.

Mol	Chain	Residues	Atoms					AltConf	Trace
			Total	C	N	O	S		
6	F	84	677	429	114	131	3	0	0

- Molecule 7 is a protein called RNA polymerase II subunit.

Mol	Chain	Residues	Atoms					AltConf	Trace
			Total	C	N	O	S		
7	G	171	1324	858	214	247	5	0	0

- Molecule 8 is a protein called DNA-directed RNA polymerases I, II, and III subunit RPABC3.

Mol	Chain	Residues	Atoms					AltConf	Trace
			Total	C	N	O	S		
8	H	133	1052	671	169	208	4	0	0

- Molecule 9 is a protein called DNA-directed RNA polymerase subunit.

Mol	Chain	Residues	Atoms					AltConf	Trace
			Total	C	N	O	S		
9	I	111	917	565	161	180	11	0	0

- Molecule 10 is a protein called RNA polymerase subunit ABC10-beta, common to RNA polymerases I, II, and III.

Mol	Chain	Residues	Atoms					AltConf	Trace
			Total	C	N	O	S		
10	J	66	545	349	95	95	6	0	0

- Molecule 11 is a protein called RNA polymerase II subunit B12.5.

Mol	Chain	Residues	Atoms					AltConf	Trace
			Total	C	N	O	S		
11	K	113	932	599	160	169	4	0	0

- Molecule 12 is a protein called RNA polymerase subunit ABC10-alpha.

Mol	Chain	Residues	Atoms					AltConf	Trace
			Total	C	N	O	S		
12	L	45	359	221	72	61	5	0	0

- Molecule 13 is a RNA chain called RNA (5'-R(P*AP*GP*CP*AP*AP*UP*AP*GP*GP*A P*GP*CP*UP*U)-3').

Mol	Chain	Residues	Atoms					AltConf	Trace
13	P	14	Total	C	N	O	P	0	0
			302	135	57	96	14		

- Molecule 14 is a DNA chain called DNA (261-MER).

Mol	Chain	Residues	Atoms					AltConf	Trace
14	T	210	Total	C	N	O	P	0	0
			4316	2047	809	1250	210		

- Molecule 15 is a DNA chain called DNA (261-MER).

Mol	Chain	Residues	Atoms					AltConf	Trace
15	N	201	Total	C	N	O	P	0	0
			4107	1954	737	1215	201		

- Molecule 16 is a protein called Histone H3.1.

Mol	Chain	Residues	Atoms					AltConf	Trace
16	a	97	Total	C	N	O	S	0	0
			801	505	155	137	4		
16	e	97	Total	C	N	O	S	0	0
			800	503	155	138	4		

There are 8 discrepancies between the modelled and reference sequences:

Chain	Residue	Modelled	Actual	Comment	Reference
a	-3	GLY	-	expression tag	UNP P68431
a	-2	SER	-	expression tag	UNP P68431
a	-1	HIS	-	expression tag	UNP P68431
a	0	MET	-	expression tag	UNP P68431
e	-3	GLY	-	expression tag	UNP P68431
e	-2	SER	-	expression tag	UNP P68431
e	-1	HIS	-	expression tag	UNP P68431
e	0	MET	-	expression tag	UNP P68431

- Molecule 17 is a protein called Histone H4.

Mol	Chain	Residues	Atoms					AltConf	Trace
17	b	83	Total	C	N	O	S	0	0
			662	418	129	114	1		
17	f	78	Total	C	N	O	S	0	0
			619	391	120	107	1		

There are 6 discrepancies between the modelled and reference sequences:

Chain	Residue	Modelled	Actual	Comment	Reference
b	-3	GLY	-	expression tag	UNP P62805
b	-2	SER	-	expression tag	UNP P62805
b	-1	HIS	-	expression tag	UNP P62805
f	-3	GLY	-	expression tag	UNP P62805
f	-2	SER	-	expression tag	UNP P62805
f	-1	HIS	-	expression tag	UNP P62805

- Molecule 18 is a protein called Histone H2A type 1-B/E.

Mol	Chain	Residues	Atoms				AltConf	Trace
18	c	105	Total	C	N	O	0	0
			810	511	158	141		
18	g	105	Total	C	N	O	0	0
			810	511	158	141		

There are 6 discrepancies between the modelled and reference sequences:

Chain	Residue	Modelled	Actual	Comment	Reference
c	-3	GLY	-	expression tag	UNP P04908
c	-2	SER	-	expression tag	UNP P04908
c	-1	HIS	-	expression tag	UNP P04908
g	-3	GLY	-	expression tag	UNP P04908
g	-2	SER	-	expression tag	UNP P04908
g	-1	HIS	-	expression tag	UNP P04908

- Molecule 19 is a protein called Histone H2B type 1-J.

Mol	Chain	Residues	Atoms					AltConf	Trace
19	d	95	Total	C	N	O	S	0	0
			746	468	136	140	2		
19	h	93	Total	C	N	O	S	0	0
			725	456	130	137	2		

There are 6 discrepancies between the modelled and reference sequences:

Chain	Residue	Modelled	Actual	Comment	Reference
d	-6	GLY	-	expression tag	UNP P06899
d	-5	SER	-	expression tag	UNP P06899
d	-4	HIS	-	expression tag	UNP P06899
h	-6	GLY	-	expression tag	UNP P06899
h	-5	SER	-	expression tag	UNP P06899

Continued on next page...

Continued from previous page...

Chain	Residue	Modelled	Actual	Comment	Reference
h	-4	HIS	-	expression tag	UNP P06899

- Molecule 20 is a protein called Histone H1.2.

Mol	Chain	Residues	Atoms				AltConf	Trace
			Total	C	N	O		
20	u	73	525	331	95	99	0	0

There are 6 discrepancies between the modelled and reference sequences:

Chain	Residue	Modelled	Actual	Comment	Reference
u	214	LEU	-	expression tag	UNP P16403
u	215	GLU	-	expression tag	UNP P16403
u	216	VAL	-	expression tag	UNP P16403
u	217	LEU	-	expression tag	UNP P16403
u	218	PHE	-	expression tag	UNP P16403
u	219	GLN	-	expression tag	UNP P16403

- Molecule 21 is ZINC ION (three-letter code: ZN) (formula: Zn).

Mol	Chain	Residues	Atoms		AltConf
			Total	Zn	
21	A	2	2	2	0
21	B	1	1	1	0
21	C	1	1	1	0
21	I	2	2	2	0
21	J	1	1	1	0
21	L	1	1	1	0

- Molecule 22 is MAGNESIUM ION (three-letter code: MG) (formula: Mg).

Mol	Chain	Residues	Atoms		AltConf
			Total	Mg	
22	A	1	1	1	0

3 Residue-property plots

These plots are drawn for all protein, RNA, DNA and oligosaccharide chains in the entry. The first graphic for a chain summarises the proportions of the various outlier classes displayed in the second graphic. The second graphic shows the sequence view annotated by issues in geometry and atom inclusion in map density. Residues are color-coded according to the number of geometric quality criteria for which they contain at least one outlier: green = 0, yellow = 1, orange = 2 and red = 3 or more. A red diamond above a residue indicates a poor fit to the EM map for this residue (all-atom inclusion < 40%). Stretches of 2 or more consecutive residues without any outlier are shown as a green connector. Residues present in the sample, but not in the model, are shown in grey.

- Molecule 1: DNA-directed RNA polymerase subunit

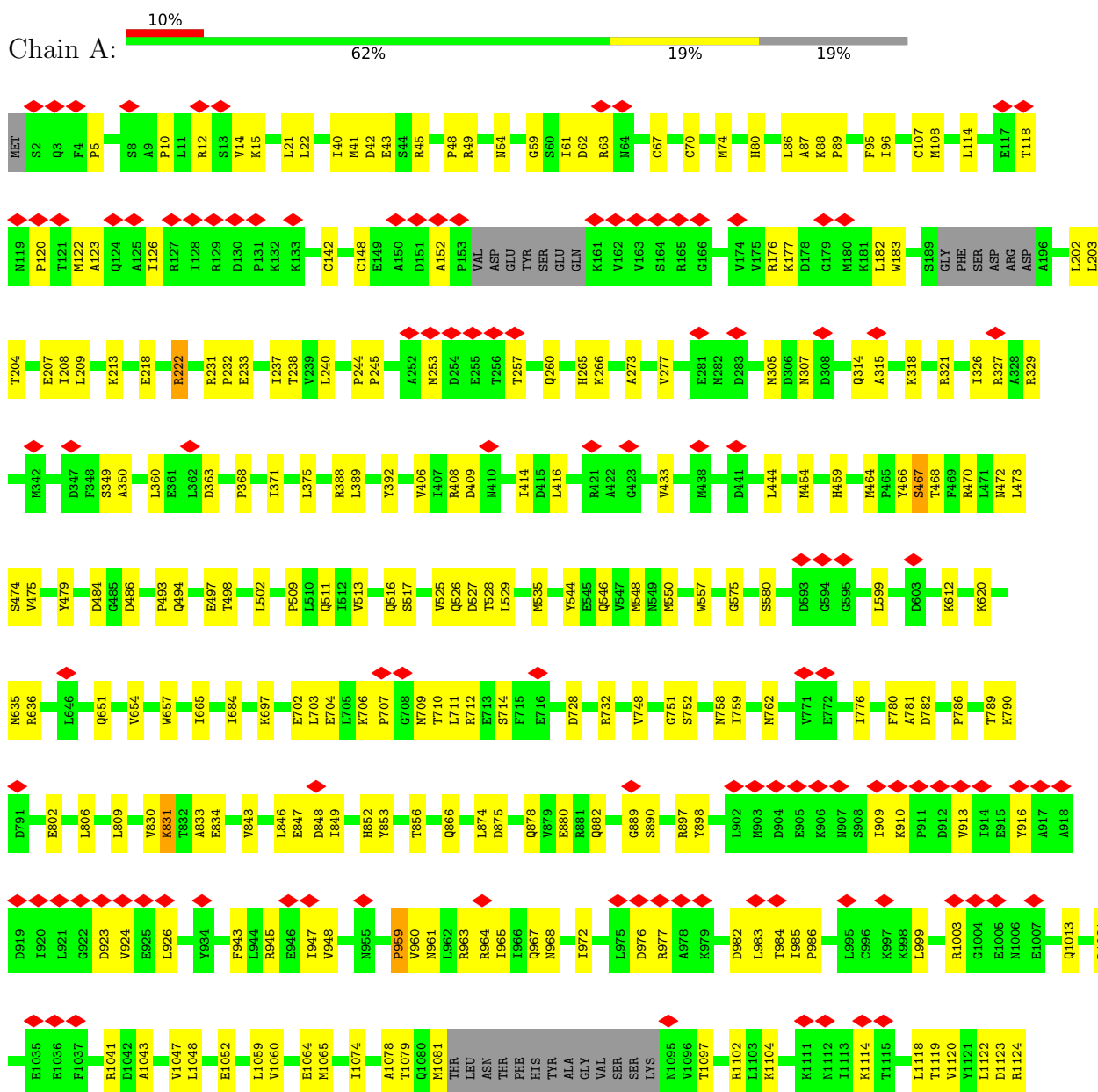

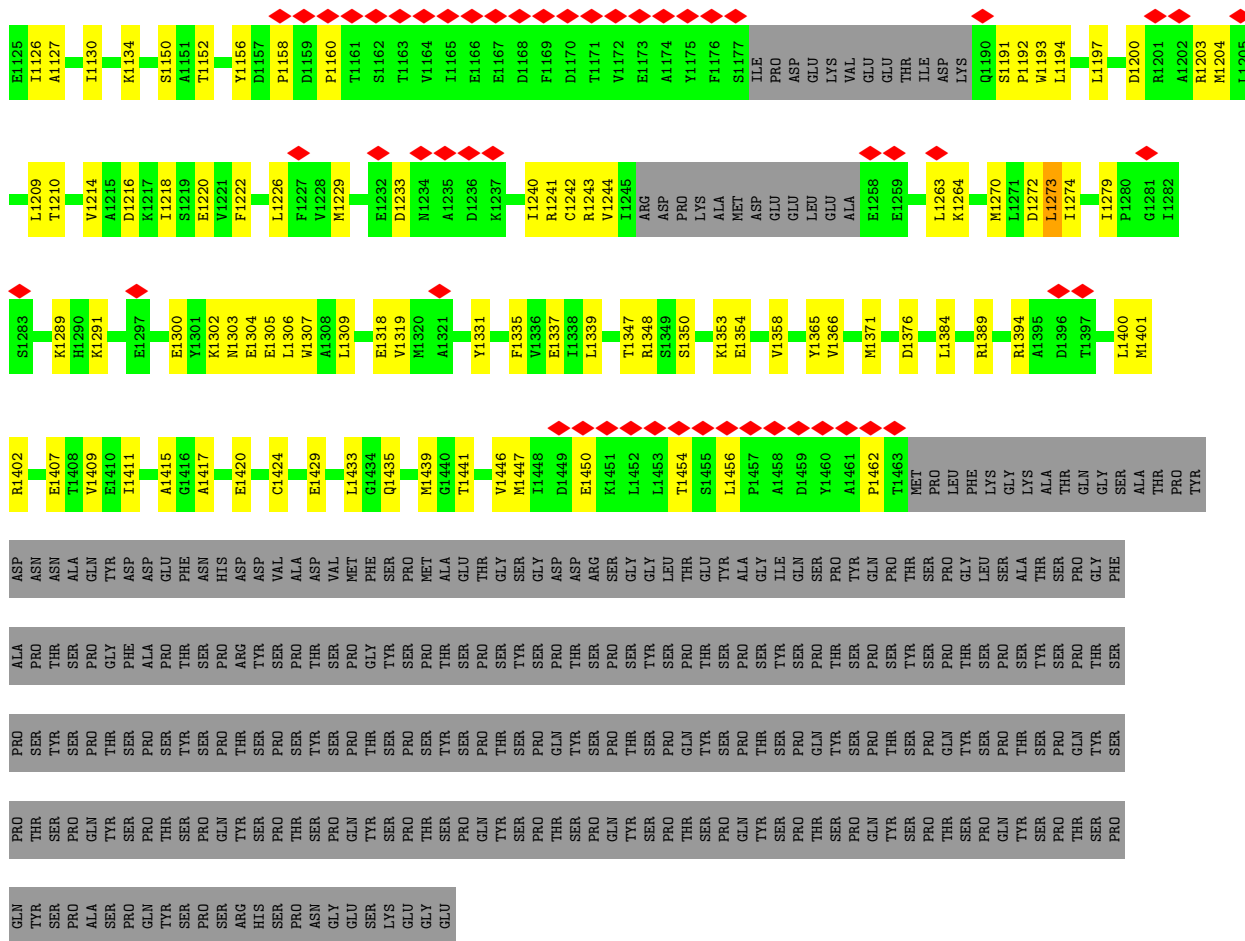

• Molecule 2: DNA-directed RNA polymerase subunit beta

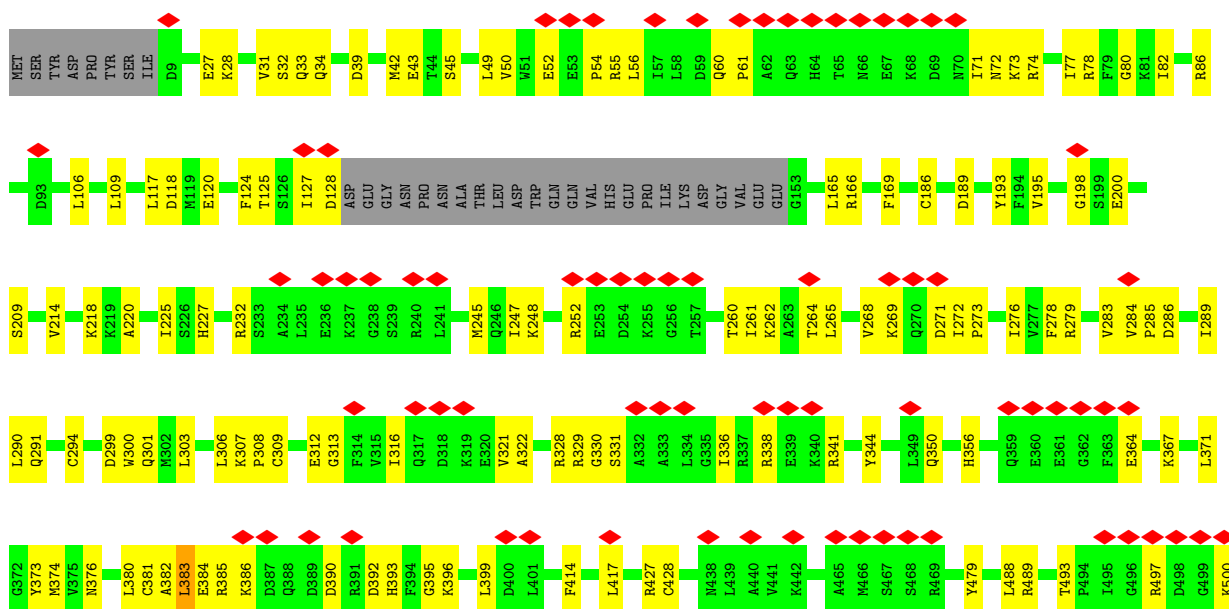

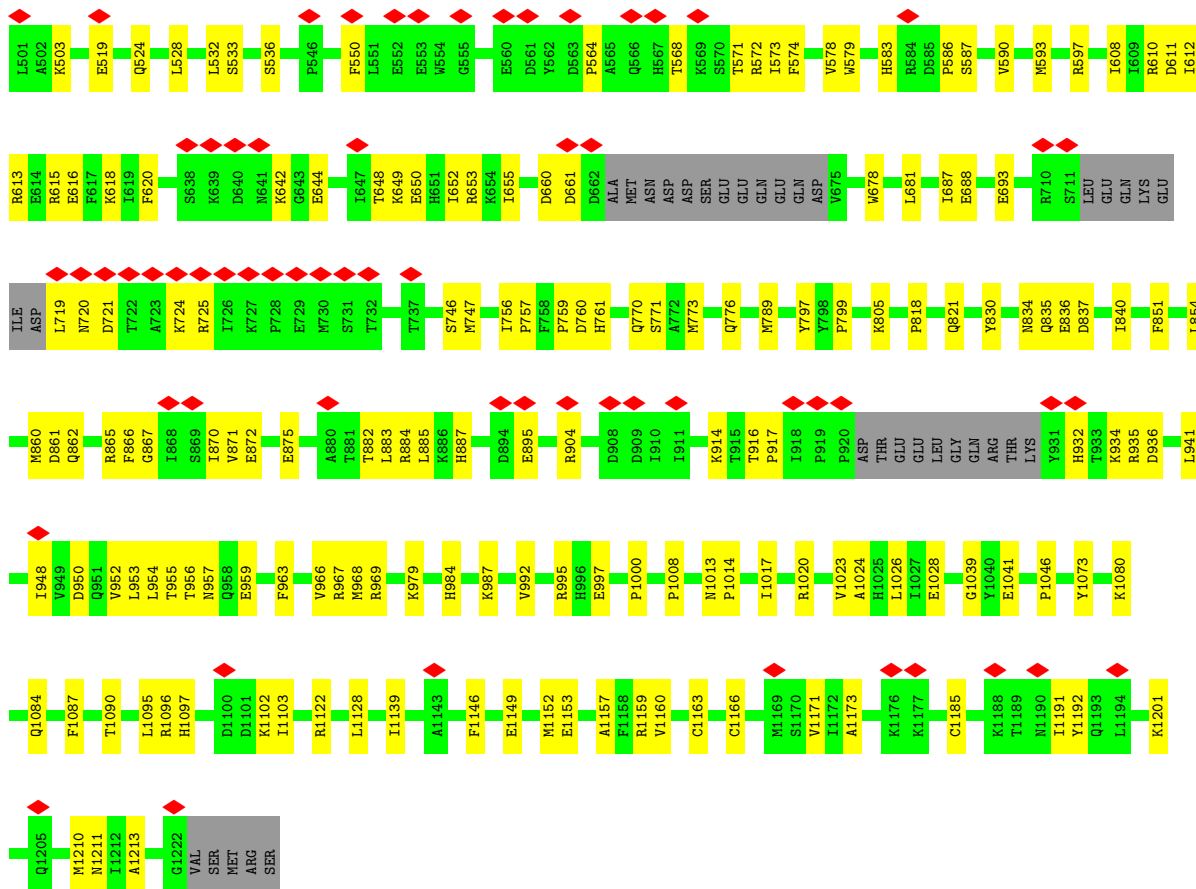

• Molecule 3: RNA polymerase II third largest subunit B44, part of central core

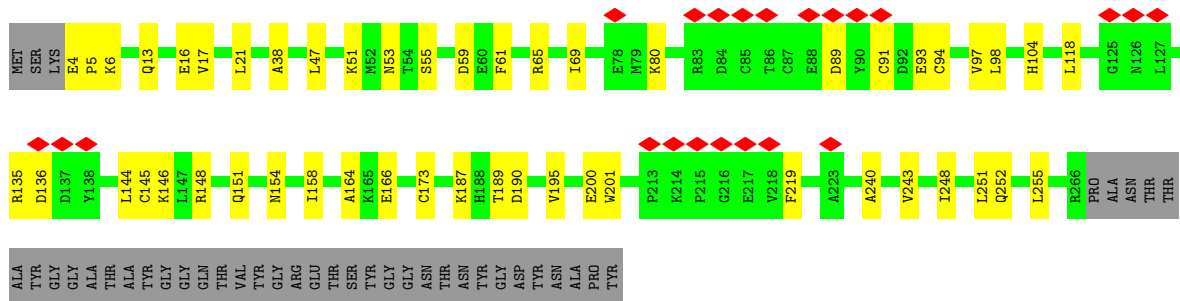

• Molecule 4: RNA polymerase II subunit B32

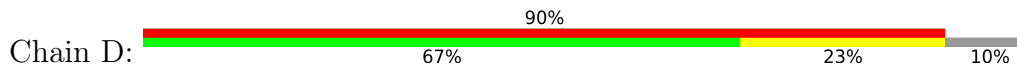

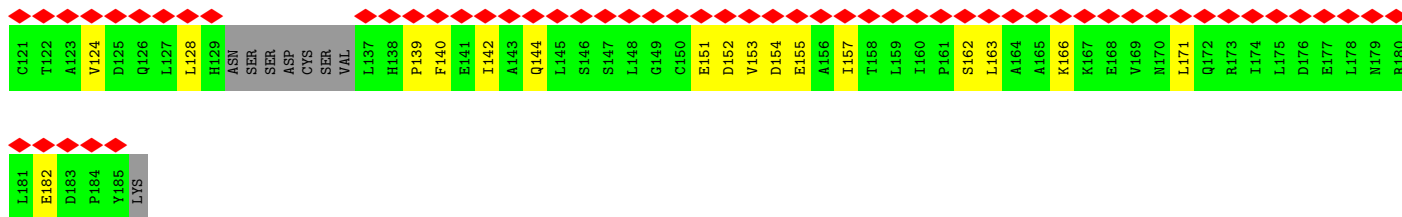

• Molecule 5: DNA-directed RNA polymerases I, II, and III subunit RPABC1

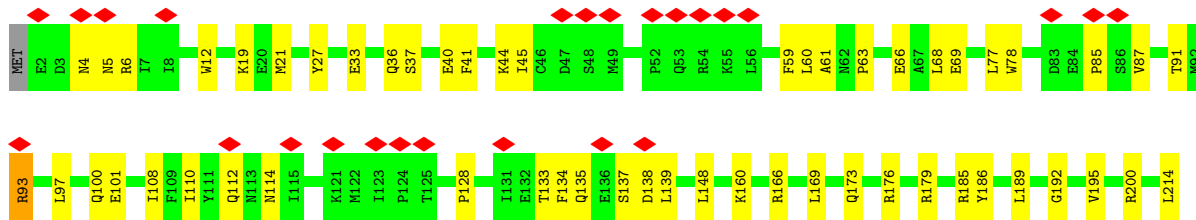
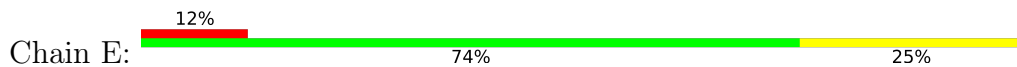

• Molecule 6: RNA polymerase subunit ABC23, common to RNA polymerases I, II, and III

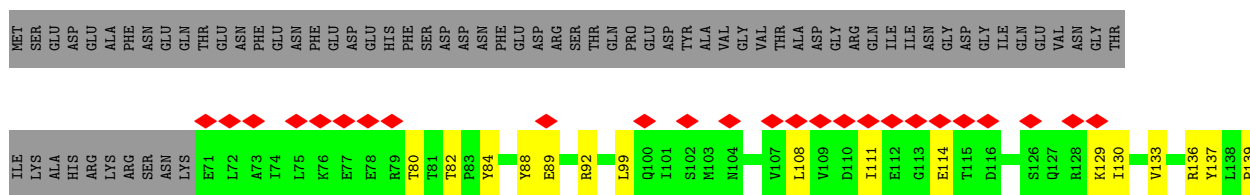

• Molecule 7: RNA polymerase II subunit



• Molecule 8: DNA-directed RNA polymerases I, II, and III subunit RPABC3

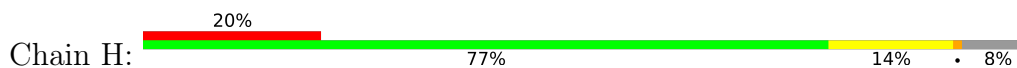

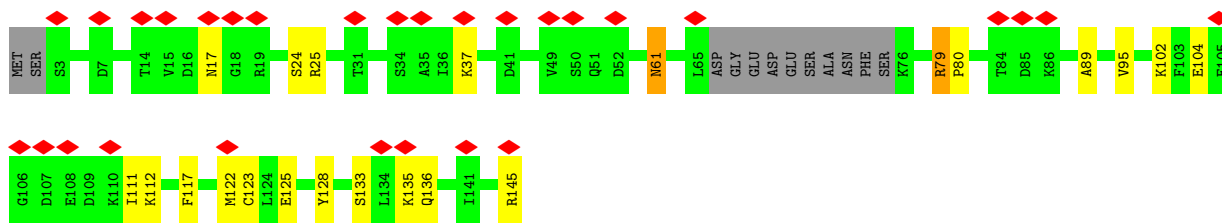

• Molecule 9: DNA-directed RNA polymerase subunit

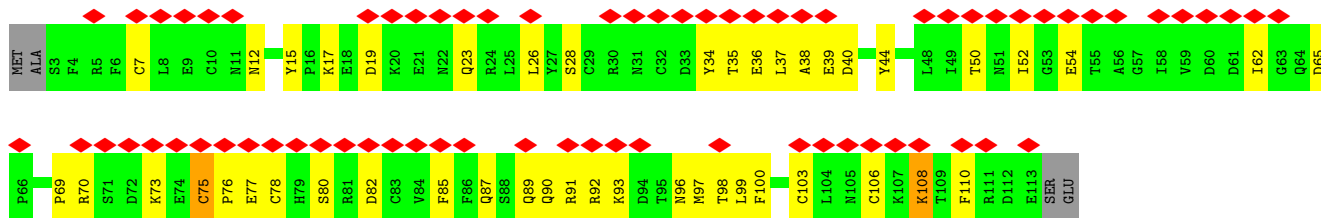

• Molecule 10: RNA polymerase subunit ABC10-beta, common to RNA polymerases I, II, and III

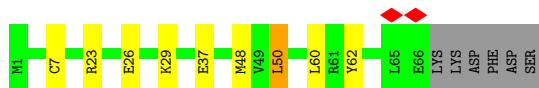
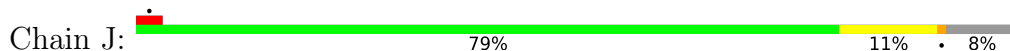

• Molecule 11: RNA polymerase II subunit B12.5

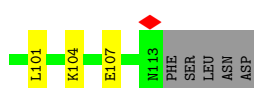

• Molecule 12: RNA polymerase subunit ABC10-alpha

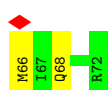
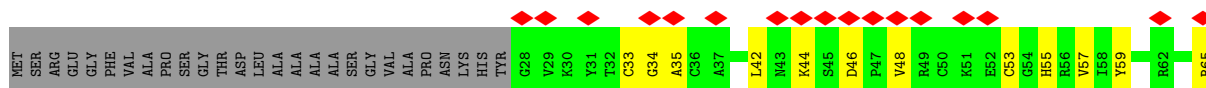
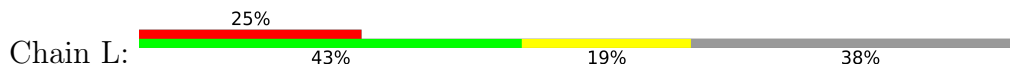

- Molecule 13: RNA (5'-R(P*AP*GP*CP*AP*AP*UP*AP*GP*GP*AP*GP*CP*UP*U)-3')

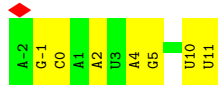

- Molecule 14: DNA (261-MER)

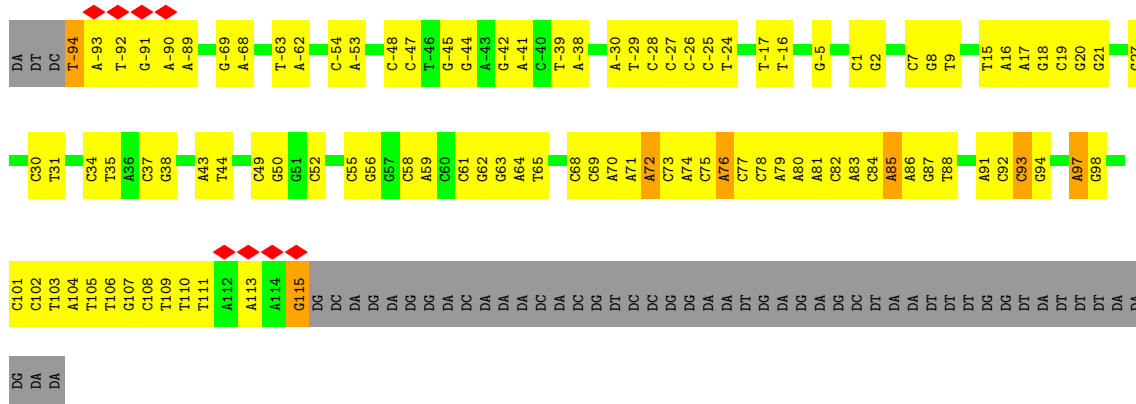

- Molecule 15: DNA (261-MER)

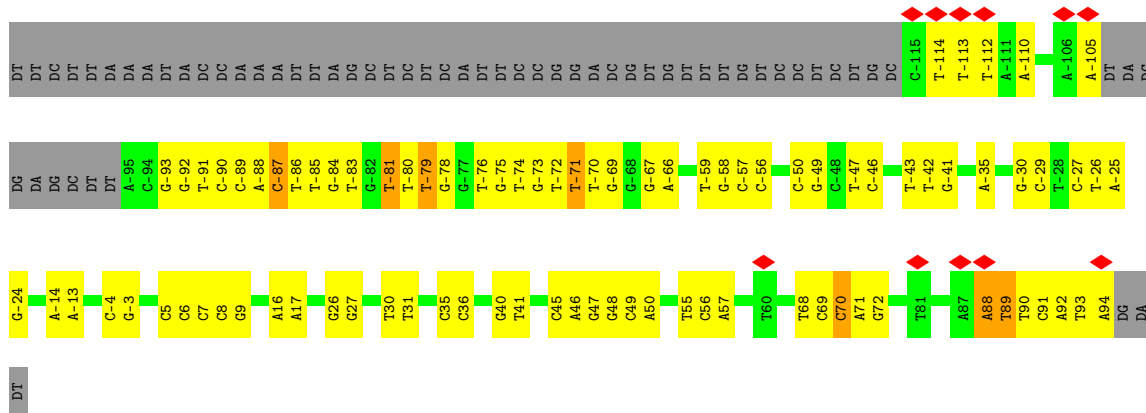

- Molecule 16: Histone H3.1

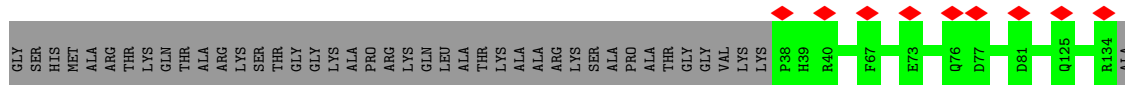

- Molecule 16: Histone H3.1

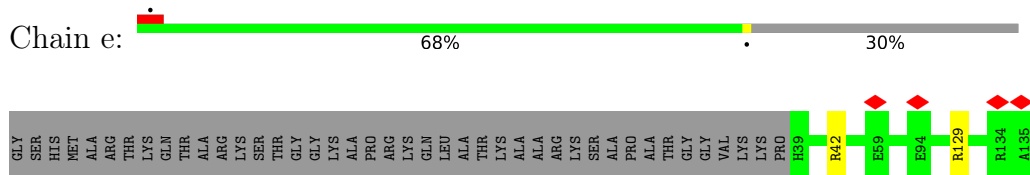

• Molecule 17: Histone H4

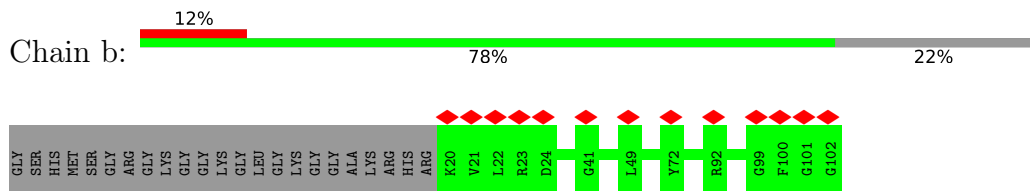

• Molecule 17: Histone H4

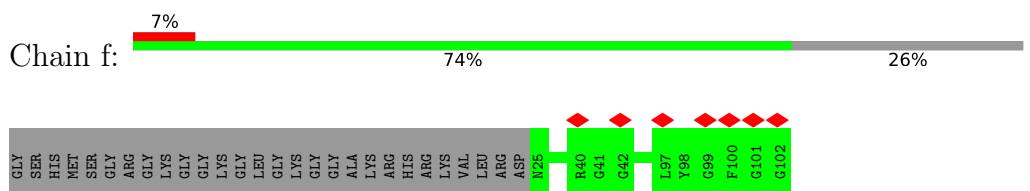

• Molecule 18: Histone H2A type 1-B/E

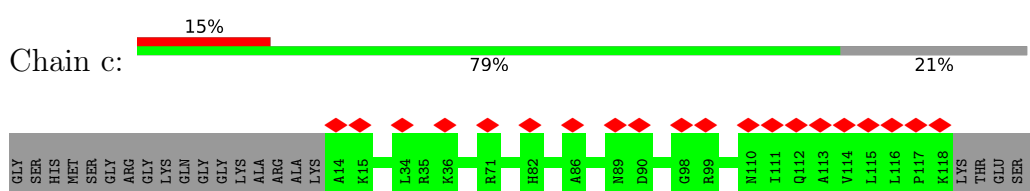

• Molecule 18: Histone H2A type 1-B/E

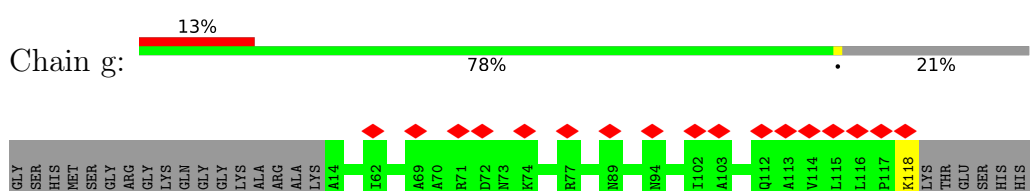

• Molecule 19: Histone H2B type 1-J

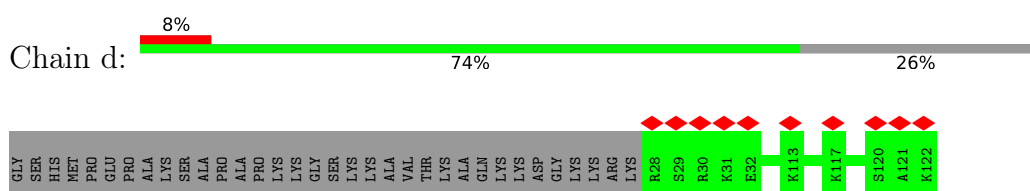

• Molecule 19: Histone H2B type 1-J

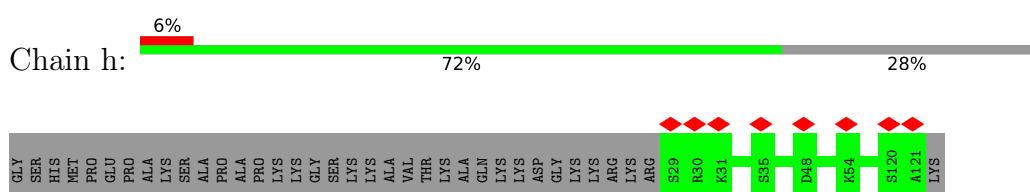

4 Experimental information

Property	Value	Source
EM reconstruction method	SINGLE PARTICLE	Depositor
Imposed symmetry	POINT, Not provided	
Number of particles used	75631	Depositor
Resolution determination method	FSC 0.143 CUT-OFF	Depositor
CTF correction method	NONE	Depositor
Microscope	FEI TITAN KRIOS	Depositor
Voltage (kV)	300	Depositor
Electron dose ($e^-/\text{\AA}^2$)	56.2	Depositor
Minimum defocus (nm)	1200	Depositor
Maximum defocus (nm)	2300	Depositor
Magnification	Not provided	
Image detector	GATAN K3 BIOQUANTUM (6k x 4k)	Depositor
Maximum map value	0.084	Depositor
Minimum map value	-0.031	Depositor
Average map value	0.000	Depositor
Map value standard deviation	0.004	Depositor
Recommended contour level	0.02	Depositor
Map size (\AA)	357.6, 357.6, 357.6	wwPDB
Map dimensions	240, 240, 240	wwPDB
Map angles ($^\circ$)	90.0, 90.0, 90.0	wwPDB
Pixel spacing (\AA)	1.49, 1.49, 1.49	Depositor

5 Model quality i

5.1 Standard geometry i

Bond lengths and bond angles in the following residue types are not validated in this section: ZN, MG

The Z score for a bond length (or angle) is the number of standard deviations the observed value is removed from the expected value. A bond length (or angle) with $|Z| > 5$ is considered an outlier worth inspection. RMSZ is the root-mean-square of all Z scores of the bond lengths (or angles).

Mol	Chain	Bond lengths		Bond angles	
		RMSZ	# Z >5	RMSZ	# Z >5
1	A	0.30	0/11326	0.57	2/15306 (0.0%)
2	B	0.31	0/9441	0.57	1/12732 (0.0%)
3	C	0.30	0/2139	0.54	0/2895
4	D	0.25	0/1326	0.55	0/1788
5	E	0.31	0/1772	0.59	1/2385 (0.0%)
6	F	0.31	0/687	0.60	0/931
7	G	0.27	0/1353	0.55	0/1837
8	H	0.29	0/1069	0.55	0/1444
9	I	0.38	1/934 (0.1%)	0.77	5/1257 (0.4%)
10	J	0.37	0/554	0.63	1/742 (0.1%)
11	K	0.29	0/953	0.55	0/1291
12	L	0.30	0/365	0.66	0/484
13	P	0.87	2/338 (0.6%)	1.08	0/525
14	T	1.00	4/4847 (0.1%)	1.36	74/7480 (1.0%)
15	N	1.00	4/4600 (0.1%)	1.33	52/7093 (0.7%)
16	a	0.31	0/813	0.59	0/1090
16	e	0.40	0/811	0.63	1/1086 (0.1%)
17	b	0.31	0/669	0.60	0/894
17	f	0.33	0/626	0.60	0/837
18	c	0.29	0/820	0.58	0/1107
18	g	0.27	0/820	0.57	0/1107
19	d	0.31	0/757	0.51	0/1015
19	h	0.29	0/736	0.55	0/990
20	u	0.26	0/528	0.58	0/704
All	All	0.53	11/48284 (0.0%)	0.81	137/67020 (0.2%)

Chiral center outliers are detected by calculating the chiral volume of a chiral center and verifying if the center is modelled as a planar moiety or with the opposite hand. A planarity outlier is detected by checking planarity of atoms in a peptide group, atoms in a mainchain group or atoms of a sidechain that are expected to be planar.

Mol	Chain	#Chirality outliers	#Planarity outliers
1	A	0	2
3	C	0	1
14	T	0	5
15	N	0	8
All	All	0	16

The worst 5 of 11 bond length outliers are listed below:

Mol	Chain	Res	Type	Atoms	Z	Observed(Å)	Ideal(Å)
14	T	94	DG	C1'-N9	-6.34	1.38	1.47
13	P	5	G	C1'-N9	-6.30	1.38	1.46
14	T	97	DA	C1'-N9	-5.83	1.39	1.47
14	T	113	DA	C1'-N9	-5.70	1.39	1.47
9	I	106	CYS	CB-SG	-5.53	1.72	1.81

The worst 5 of 137 bond angle outliers are listed below:

Mol	Chain	Res	Type	Atoms	Z	Observed(°)	Ideal(°)
15	N	-88	DA	N1-C6-N6	-9.82	112.71	118.60
15	N	94	DA	N1-C6-N6	-9.53	112.88	118.60
14	T	-89	DA	N1-C6-N6	-9.21	113.07	118.60
15	N	88	DA	N1-C6-N6	-9.15	113.11	118.60
14	T	81	DA	N1-C6-N6	-9.02	113.19	118.60

There are no chirality outliers.

5 of 16 planarity outliers are listed below:

Mol	Chain	Res	Type	Group
1	A	525	VAL	Peptide
1	A	959	PRO	Peptide
3	C	89	ASP	Peptide
14	T	-94	DT	Sidechain
14	T	72	DA	Sidechain

5.2 Too-close contacts

In the following table, the Non-H and H(model) columns list the number of non-hydrogen atoms and hydrogen atoms in the chain respectively. The H(added) column lists the number of hydrogen atoms added and optimized by MolProbity. The Clashes column lists the number of clashes within the asymmetric unit, whereas Symm-Clashes lists symmetry-related clashes.

Mol	Chain	Non-H	H(model)	H(added)	Clashes	Symm-Clashes
1	A	11120	0	11150	247	0
2	B	9261	0	9265	218	0
3	C	2098	0	2057	33	0
4	D	1314	0	1314	31	0
5	E	1740	0	1754	39	0
6	F	677	0	693	16	0
7	G	1324	0	1342	47	0
8	H	1052	0	1050	19	0
9	I	917	0	865	41	0
10	J	545	0	560	8	0
11	K	932	0	944	30	0
12	L	359	0	358	11	0
13	P	302	0	152	5	0
14	T	4316	0	2356	50	0
15	N	4107	0	2265	37	0
16	a	801	0	839	0	0
16	e	800	0	836	0	0
17	b	662	0	709	0	0
17	f	619	0	659	0	0
18	c	810	0	866	0	0
18	g	810	0	866	0	0
19	d	746	0	771	0	0
19	h	725	0	745	0	0
20	u	525	0	581	0	0
21	A	2	0	0	0	0
21	B	1	0	0	0	0
21	C	1	0	0	0	0
21	I	2	0	0	0	0
21	J	1	0	0	0	0
21	L	1	0	0	0	0
22	A	1	0	0	0	0
All	All	46571	0	42997	736	0

The all-atom clashscore is defined as the number of clashes found per 1000 atoms (including hydrogen atoms). The all-atom clashscore for this structure is 10.

The worst 5 of 736 close contacts within the same asymmetric unit are listed below, sorted by their clash magnitude.

Atom-1	Atom-2	Interatomic distance (Å)	Clash overlap (Å)
2:B:316:ILE:HG21	2:B:322:ALA:HB2	1.49	0.94
12:L:42:LEU:HD11	12:L:46:ASP:HB2	1.57	0.85
1:A:203:LEU:HD23	1:A:208:ILE:HD11	1.58	0.85

Continued on next page...

Continued from previous page...

Atom-1	Atom-2	Interatomic distance (Å)	Clash overlap (Å)
1:A:486:ASP:OD1	13:P:10:U:O2'	1.95	0.83
9:I:17:LYS:HD2	9:I:28:SER:HB2	1.59	0.83

There are no symmetry-related clashes.

5.3 Torsion angles [i](#)

5.3.1 Protein backbone [i](#)

In the following table, the Percentiles column shows the percent Ramachandran outliers of the chain as a percentile score with respect to all PDB entries followed by that with respect to all EM entries.

The Analysed column shows the number of residues for which the backbone conformation was analysed, and the total number of residues.

Mol	Chain	Analysed	Favoured	Allowed	Outliers	Percentiles	
1	A	1400/1743 (80%)	1338 (96%)	59 (4%)	3 (0%)	47	79
2	B	1151/1227 (94%)	1104 (96%)	46 (4%)	1 (0%)	51	83
3	C	261/304 (86%)	253 (97%)	8 (3%)	0	100	100
4	D	162/186 (87%)	154 (95%)	8 (5%)	0	100	100
5	E	211/214 (99%)	203 (96%)	8 (4%)	0	100	100
6	F	82/155 (53%)	80 (98%)	2 (2%)	0	100	100
7	G	169/171 (99%)	163 (96%)	6 (4%)	0	100	100
8	H	129/145 (89%)	123 (95%)	6 (5%)	0	100	100
9	I	109/115 (95%)	106 (97%)	3 (3%)	0	100	100
10	J	64/72 (89%)	62 (97%)	2 (3%)	0	100	100
11	K	111/118 (94%)	109 (98%)	2 (2%)	0	100	100
12	L	43/72 (60%)	40 (93%)	3 (7%)	0	100	100
16	a	95/139 (68%)	94 (99%)	1 (1%)	0	100	100
16	e	95/139 (68%)	92 (97%)	3 (3%)	0	100	100
17	b	81/106 (76%)	79 (98%)	2 (2%)	0	100	100
17	f	76/106 (72%)	74 (97%)	2 (3%)	0	100	100
18	c	103/133 (77%)	99 (96%)	4 (4%)	0	100	100
18	g	103/133 (77%)	99 (96%)	4 (4%)	0	100	100

Continued on next page...

Continued from previous page...

Mol	Chain	Analysed	Favoured	Allowed	Outliers	Percentiles	
19	d	93/129 (72%)	91 (98%)	2 (2%)	0	100	100
19	h	91/129 (70%)	90 (99%)	1 (1%)	0	100	100
20	u	71/219 (32%)	65 (92%)	6 (8%)	0	100	100
All	All	4700/5755 (82%)	4518 (96%)	178 (4%)	4 (0%)	54	83

All (4) Ramachandran outliers are listed below:

Mol	Chain	Res	Type
1	A	467	SER
1	A	959	PRO
2	B	61	PRO
1	A	960	VAL

5.3.2 Protein sidechains [i](#)

In the following table, the Percentiles column shows the percent sidechain outliers of the chain as a percentile score with respect to all PDB entries followed by that with respect to all EM entries.

The Analysed column shows the number of residues for which the sidechain conformation was analysed, and the total number of residues.

Mol	Chain	Analysed	Rotameric	Outliers	Percentiles	
1	A	1225/1528 (80%)	1222 (100%)	3 (0%)	93	97
2	B	1016/1077 (94%)	1015 (100%)	1 (0%)	93	97
3	C	236/264 (89%)	236 (100%)	0	100	100
4	D	143/160 (89%)	143 (100%)	0	100	100
5	E	196/197 (100%)	194 (99%)	2 (1%)	76	86
6	F	75/137 (55%)	75 (100%)	0	100	100
7	G	148/148 (100%)	148 (100%)	0	100	100
8	H	120/130 (92%)	118 (98%)	2 (2%)	60	78
9	I	106/109 (97%)	105 (99%)	1 (1%)	78	88
10	J	60/66 (91%)	60 (100%)	0	100	100
11	K	104/109 (95%)	104 (100%)	0	100	100
12	L	38/56 (68%)	38 (100%)	0	100	100
16	a	85/113 (75%)	85 (100%)	0	100	100

Continued on next page...

Continued from previous page...

Mol	Chain	Analysed	Rotameric	Outliers	Percentiles	
16	e	84/113 (74%)	83 (99%)	1 (1%)	71	84
17	b	68/81 (84%)	68 (100%)	0	100	100
17	f	63/81 (78%)	63 (100%)	0	100	100
18	c	83/102 (81%)	83 (100%)	0	100	100
18	g	83/102 (81%)	82 (99%)	1 (1%)	71	84
19	d	81/107 (76%)	81 (100%)	0	100	100
19	h	79/107 (74%)	79 (100%)	0	100	100
20	u	56/155 (36%)	56 (100%)	0	100	100
All	All	4149/4942 (84%)	4138 (100%)	11 (0%)	92	96

5 of 11 residues with a non-rotameric sidechain are listed below:

Mol	Chain	Res	Type
8	H	79	ARG
9	I	108	LYS
18	g	118	LYS
16	e	129	ARG
5	E	114	ASN

Sometimes sidechains can be flipped to improve hydrogen bonding and reduce clashes. 5 of 15 such sidechains are listed below:

Mol	Chain	Res	Type
2	B	984	HIS
19	d	60	ASN
2	B	1074	ASN
20	u	95	GLN
7	G	24	GLN

5.3.3 RNA [i](#)

Mol	Chain	Analysed	Backbone Outliers	Pucker Outliers
13	P	13/14 (92%)	2 (15%)	0

All (2) RNA backbone outliers are listed below:

Mol	Chain	Res	Type
13	P	0	C

Continued on next page...

Continued from previous page...

Mol	Chain	Res	Type
13	P	11	U

There are no RNA pucker outliers to report.

5.4 Non-standard residues in protein, DNA, RNA chains [i](#)

There are no non-standard protein/DNA/RNA residues in this entry.

5.5 Carbohydrates [i](#)

There are no monosaccharides in this entry.

5.6 Ligand geometry [i](#)

Of 9 ligands modelled in this entry, 9 are monoatomic - leaving 0 for Mogul analysis.

There are no bond length outliers.

There are no bond angle outliers.

There are no chirality outliers.

There are no torsion outliers.

There are no ring outliers.

No monomer is involved in short contacts.

5.7 Other polymers [i](#)

There are no such residues in this entry.

5.8 Polymer linkage issues [i](#)

There are no chain breaks in this entry.

6 Map visualisation [i](#)

This section contains visualisations of the EMDB entry EMD-34415. These allow visual inspection of the internal detail of the map and identification of artifacts.

Images derived from a raw map, generated by summing the deposited half-maps, are presented below the corresponding image components of the primary map to allow further visual inspection and comparison with those of the primary map.

6.1 Orthogonal projections [i](#)

6.1.1 Primary map

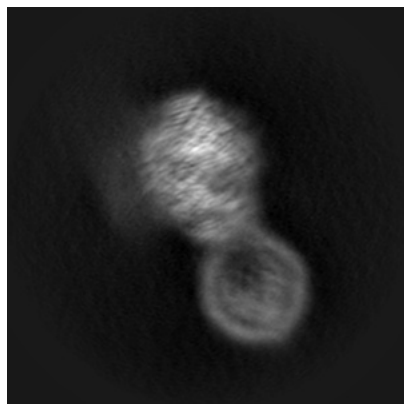

X

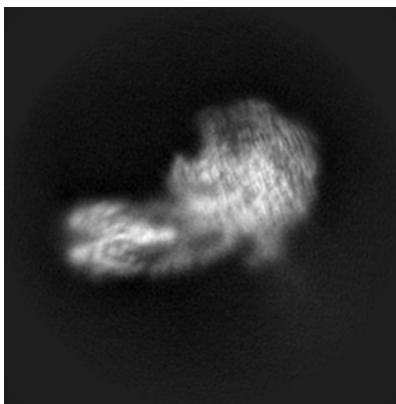

Y

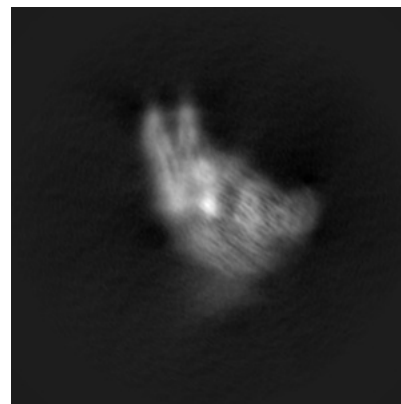

Z

6.1.2 Raw map

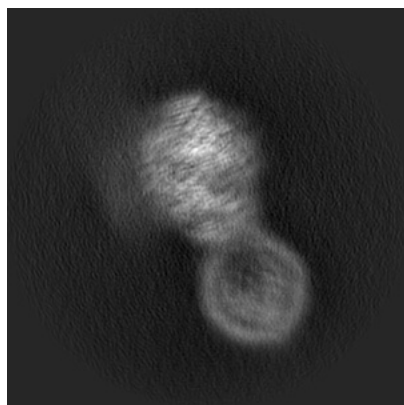

X

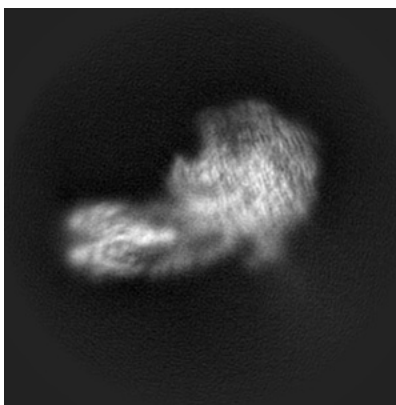

Y

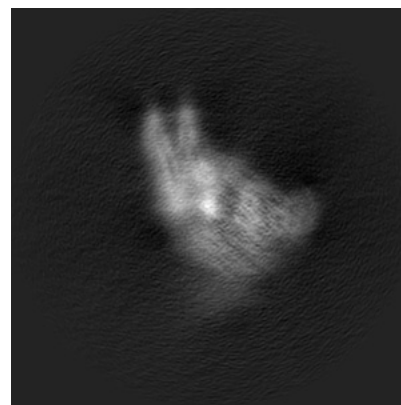

Z

The images above show the map projected in three orthogonal directions.

6.2 Central slices [i](#)

6.2.1 Primary map

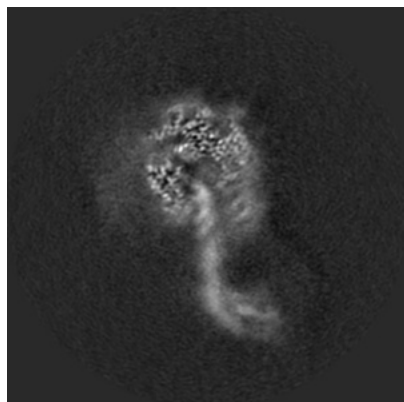

X Index: 120

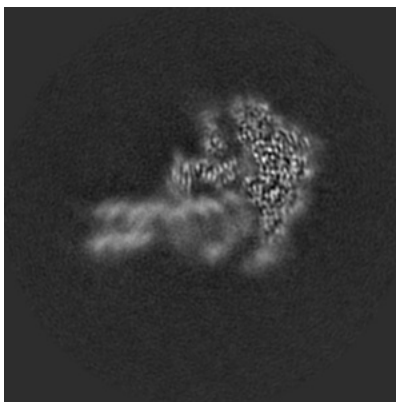

Y Index: 120

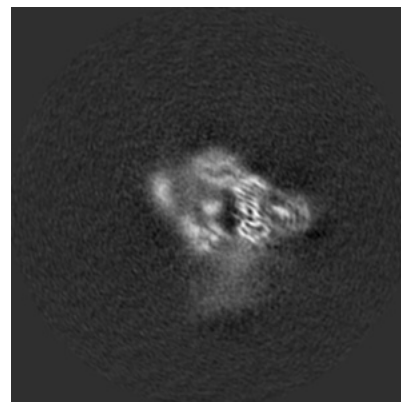

Z Index: 120

6.2.2 Raw map

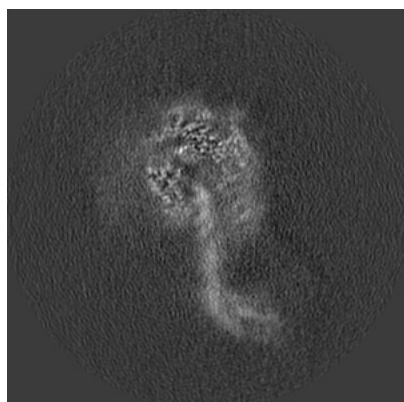

X Index: 120

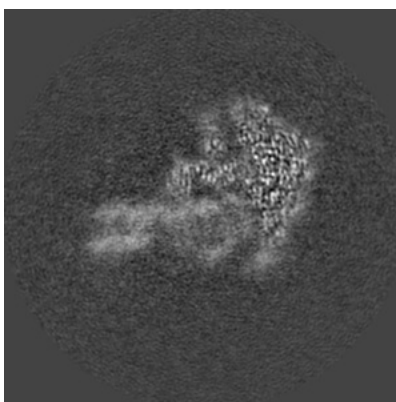

Y Index: 120

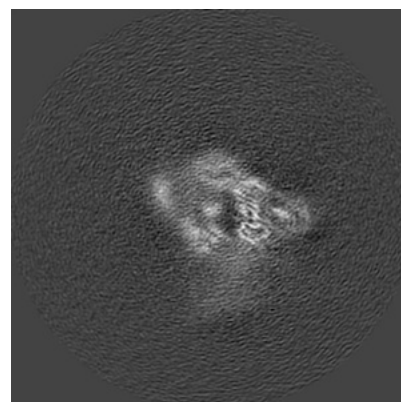

Z Index: 120

The images above show central slices of the map in three orthogonal directions.

6.3 Largest variance slices [i](#)

6.3.1 Primary map

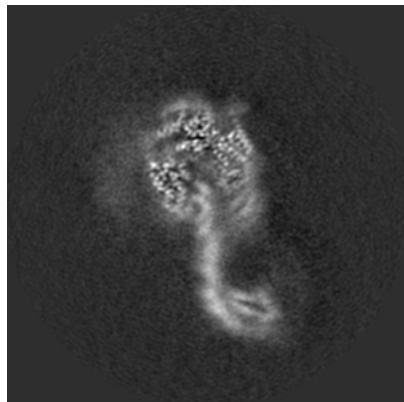

X Index: 118

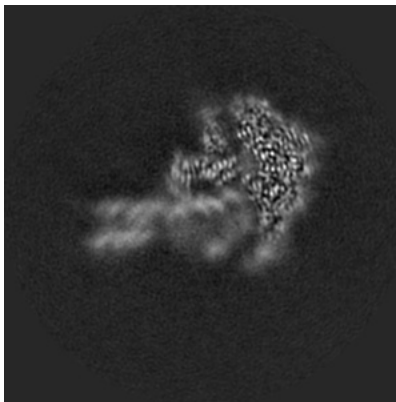

Y Index: 119

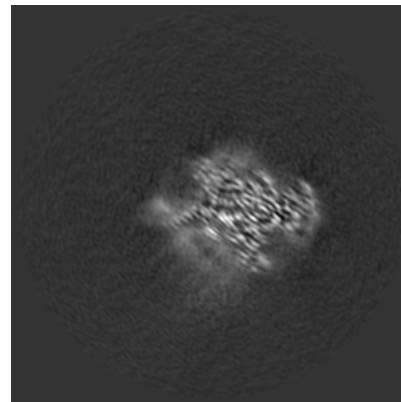

Z Index: 154

6.3.2 Raw map

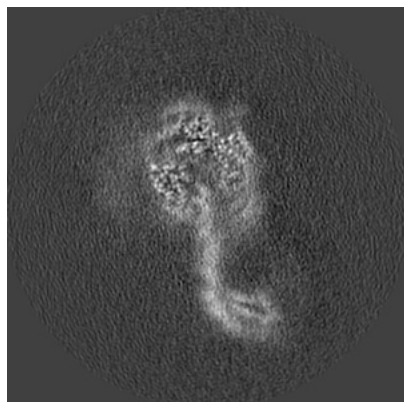

X Index: 118

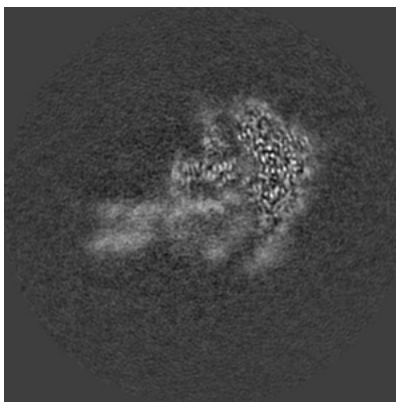

Y Index: 119

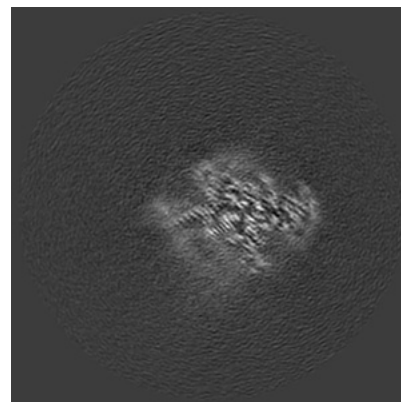

Z Index: 155

The images above show the largest variance slices of the map in three orthogonal directions.

6.4 Orthogonal surface views [i](#)

6.4.1 Primary map

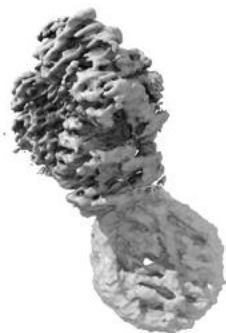

X



Y

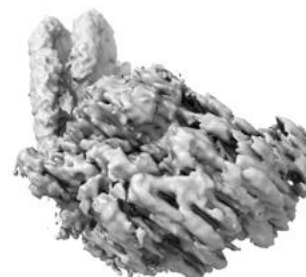

Z

The images above show the 3D surface view of the map at the recommended contour level 0.02. These images, in conjunction with the slice images, may facilitate assessment of whether an appropriate contour level has been provided.

6.4.2 Raw map



X



Y



Z

These images show the 3D surface of the raw map. The raw map's contour level was selected so that its surface encloses the same volume as the primary map does at its recommended contour level.

6.5 Mask visualisation [i](#)

This section was not generated. No masks/segmentation were deposited.

7 Map analysis [i](#)

This section contains the results of statistical analysis of the map.

7.1 Map-value distribution [i](#)

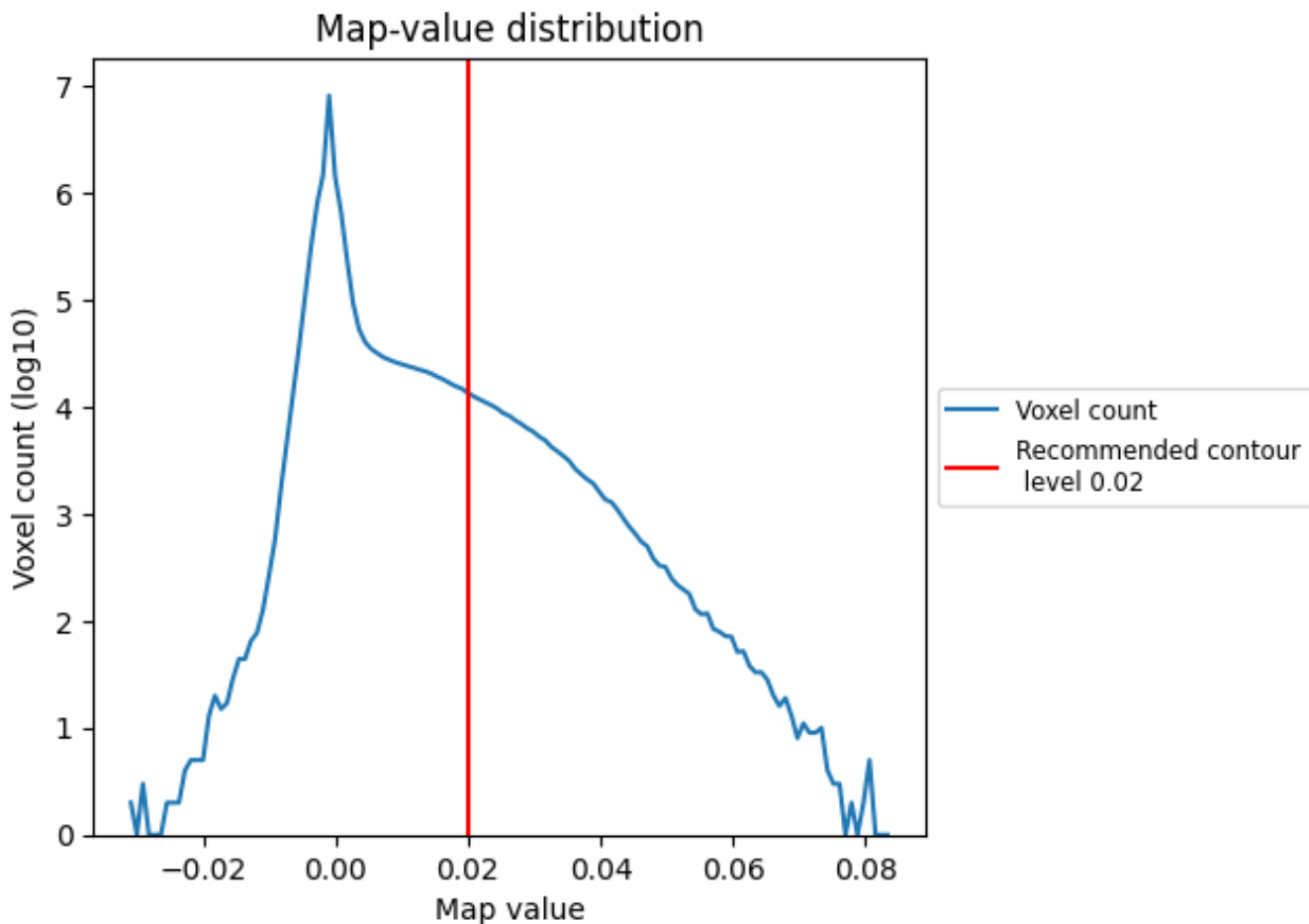

The map-value distribution is plotted in 128 intervals along the x-axis. The y-axis is logarithmic. A spike in this graph at zero usually indicates that the volume has been masked.

7.2 Volume estimate [\(i\)](#)

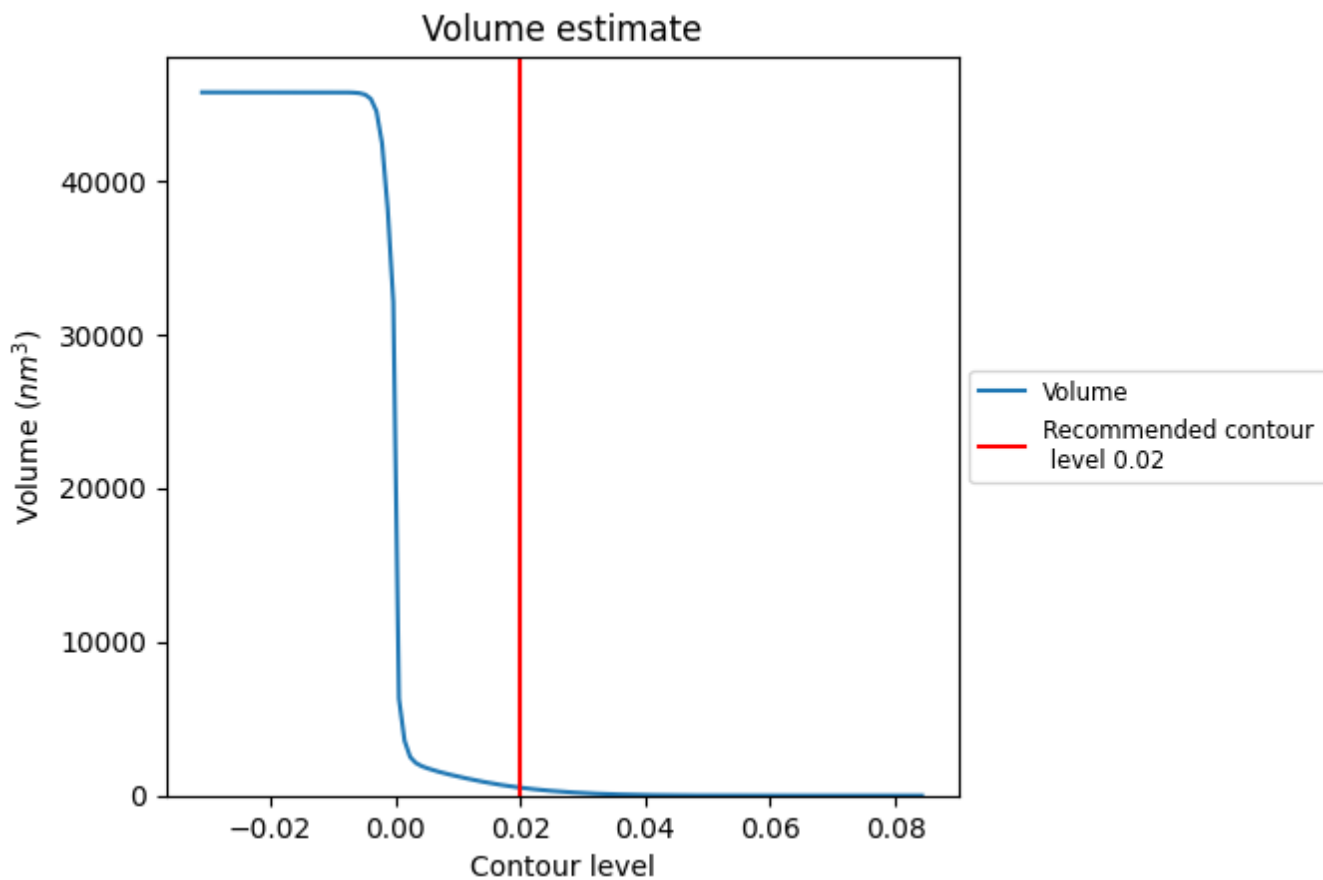

The volume at the recommended contour level is 517 nm³; this corresponds to an approximate mass of 467 kDa.

The volume estimate graph shows how the enclosed volume varies with the contour level. The recommended contour level is shown as a vertical line and the intersection between the line and the curve gives the volume of the enclosed surface at the given level.

7.3 Rotationally averaged power spectrum [i](#)

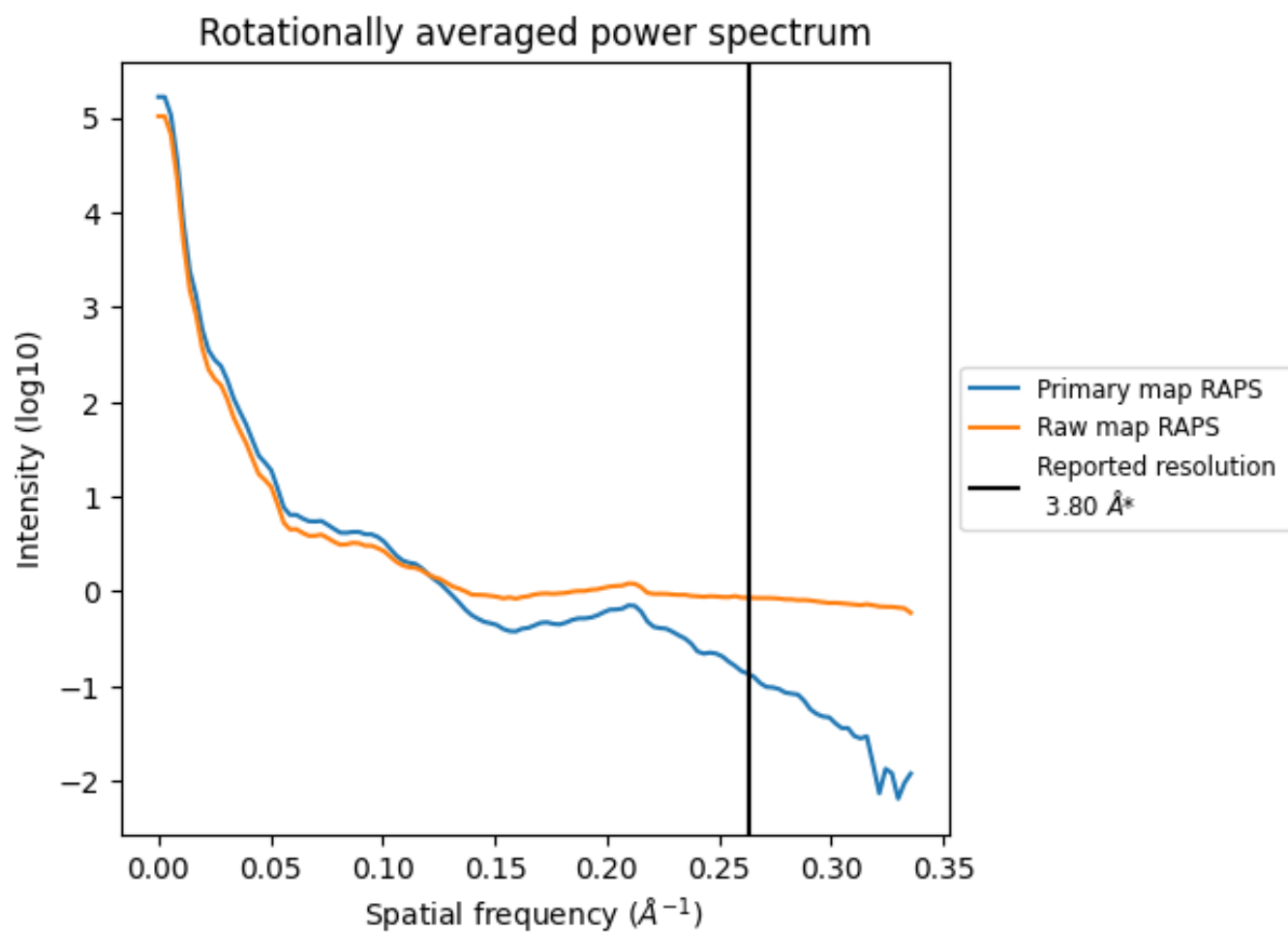

*Reported resolution corresponds to spatial frequency of 0.263 Å⁻¹

8 Fourier-Shell correlation [i](#)

Fourier-Shell Correlation (FSC) is the most commonly used method to estimate the resolution of single-particle and subtomogram-averaged maps. The shape of the curve depends on the imposed symmetry, mask and whether or not the two 3D reconstructions used were processed from a common reference. The reported resolution is shown as a black line. A curve is displayed for the half-bit criterion in addition to lines showing the 0.143 gold standard cut-off and 0.5 cut-off.

8.1 FSC [i](#)

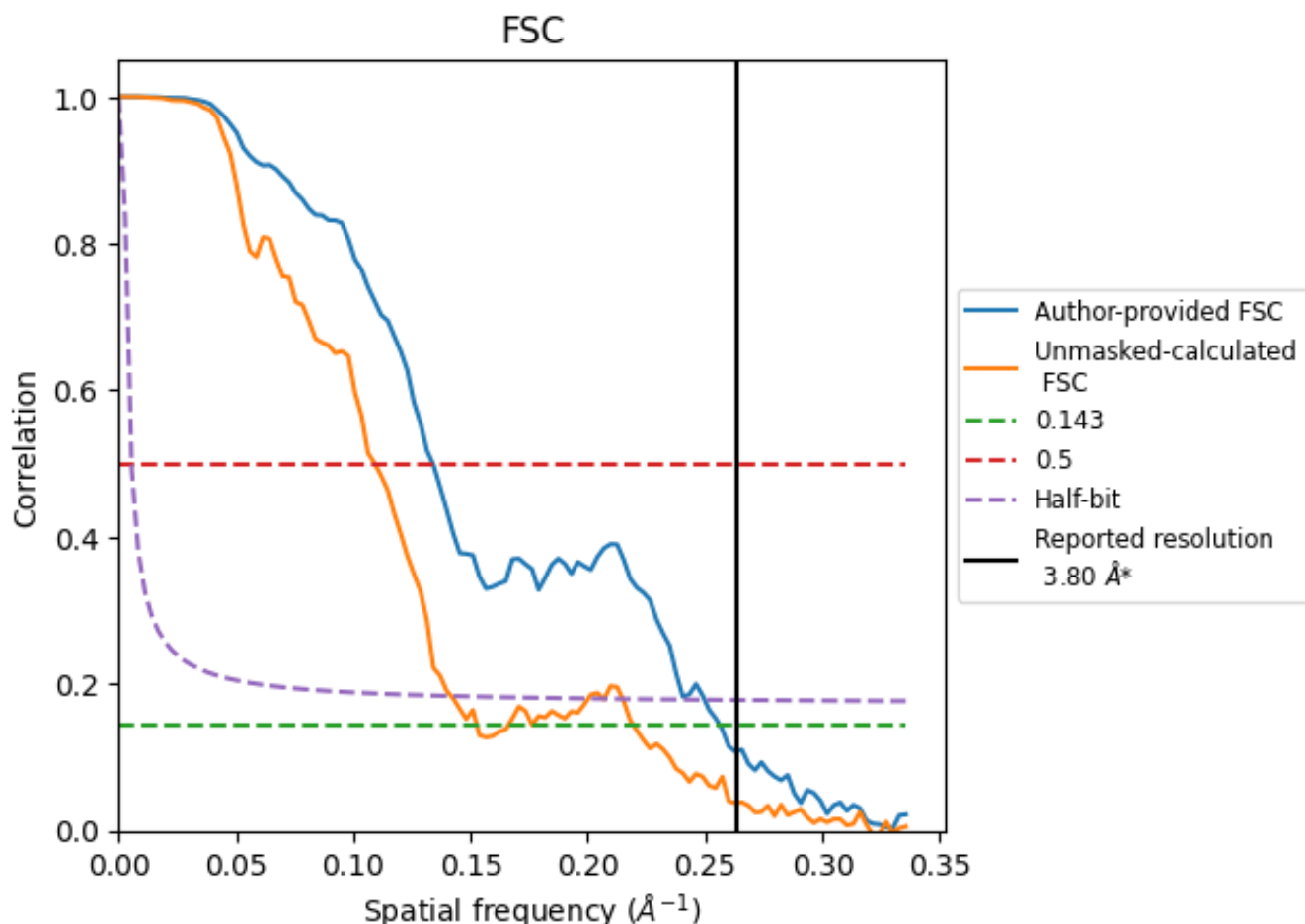

*Reported resolution corresponds to spatial frequency of 0.263\AA^{-1}

8.2 Resolution estimates [i](#)

Resolution estimate (Å)	Estimation criterion (FSC cut-off)		
	0.143	0.5	Half-bit
Reported by author	3.80	-	-
Author-provided FSC curve	3.90	7.47	4.00
Unmasked-calculated*	6.55	9.17	7.06

*Resolution estimate based on FSC curve calculated by comparison of deposited half-maps. The value from deposited half-maps intersecting FSC 0.143 CUT-OFF 6.55 differs from the reported value 3.8 by more than 10 %

9 Map-model fit [i](#)

This section contains information regarding the fit between EMDB map EMD-34415 and PDB model 8H0V. Per-residue inclusion information can be found in section 3 on page 9.

9.1 Map-model overlay [i](#)

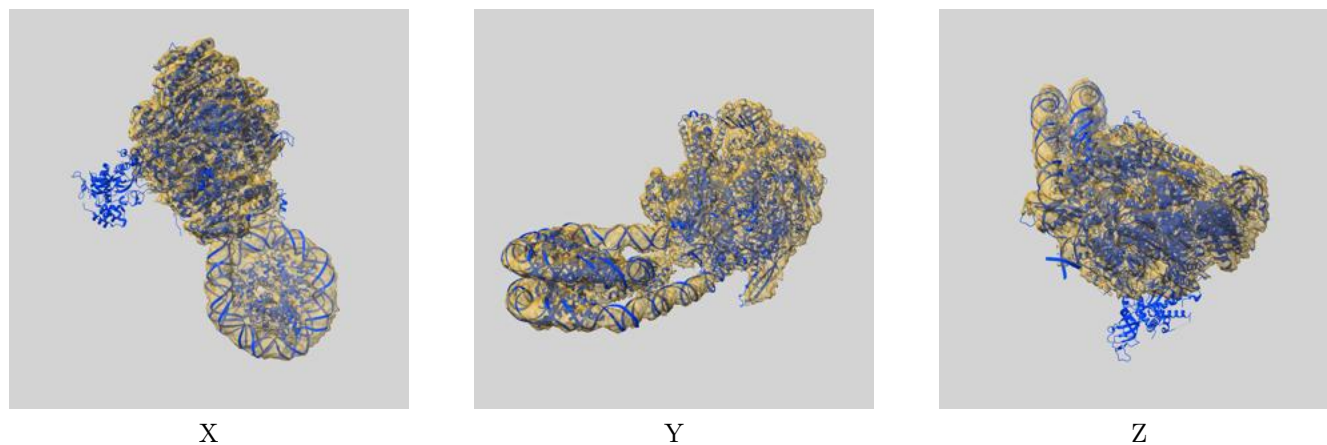

The images above show the 3D surface view of the map at the recommended contour level 0.02 at 50% transparency in yellow overlaid with a ribbon representation of the model coloured in blue. These images allow for the visual assessment of the quality of fit between the atomic model and the map.

9.2 Q-score mapped to coordinate model [i](#)



The images above show the model with each residue coloured according to its Q-score. This shows their resolvability in the map with higher Q-score values reflecting better resolvability. Please note: Q-score is calculating the resolvability of atoms, and thus high values are only expected at resolutions at which atoms can be resolved. Low Q-score values may therefore be expected for many entries.

9.3 Atom inclusion mapped to coordinate model [i](#)

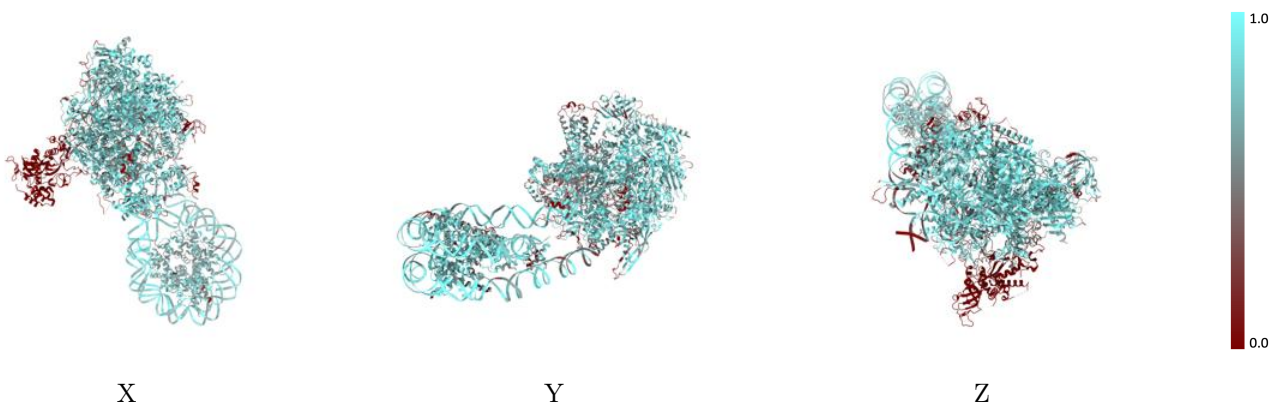

The images above show the model with each residue coloured according to its atom inclusion. This shows to what extent they are inside the map at the recommended contour level (0.02).



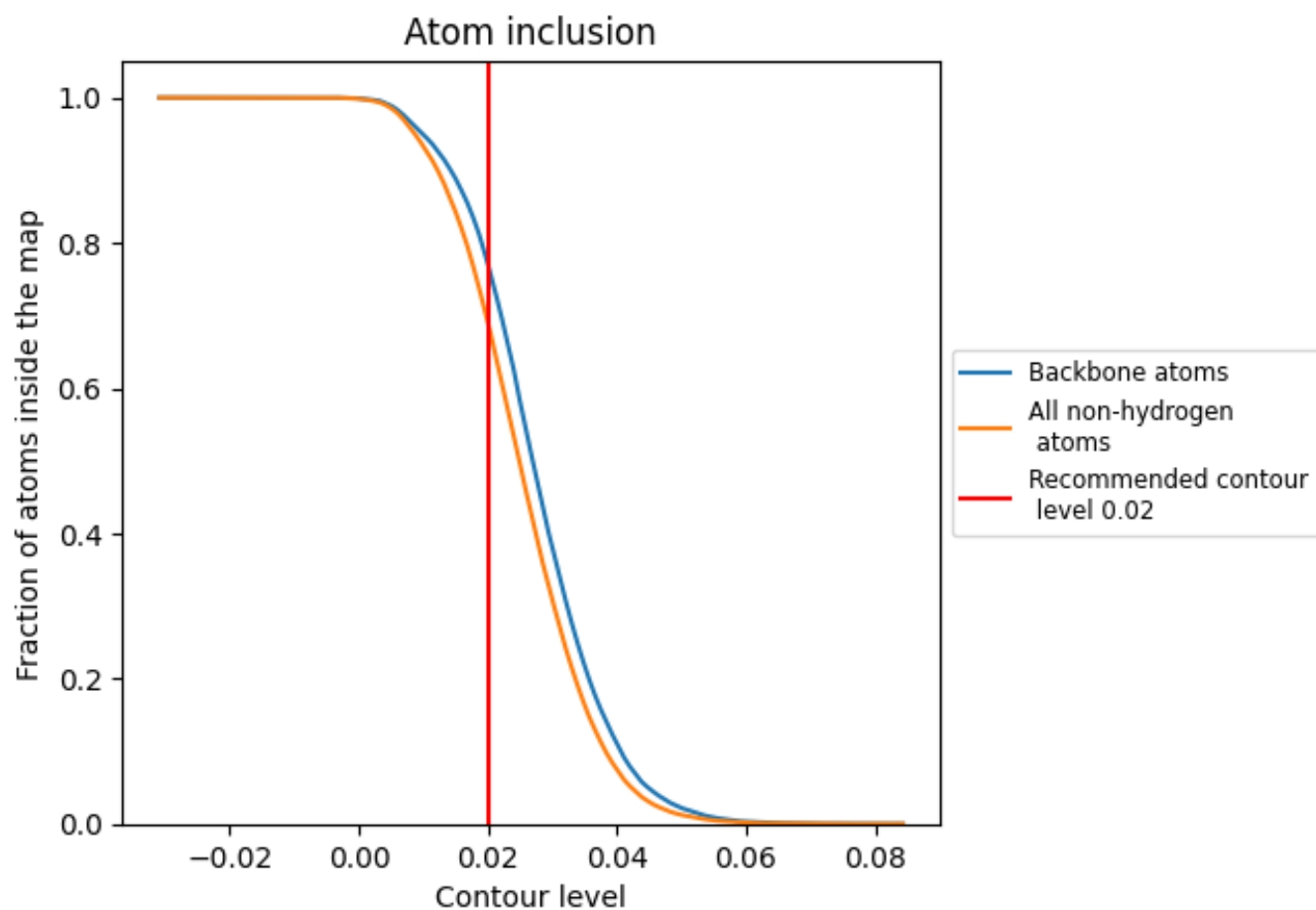















































9.4 Atom inclusion [i](#)



At the recommended contour level, 77% of all backbone atoms, 69% of all non-hydrogen atoms, are inside the map.

9.5 Map-model fit summary

The table lists the average atom inclusion at the recommended contour level (0.02) and Q-score for the entire model and for each chain.

Chain	Atom inclusion	Q-score
All	 0.6912	 0.2280
A	 0.7265	 0.2830
B	 0.7468	 0.2950
C	 0.7455	 0.3160
D	 0.0016	 0.0390
E	 0.7637	 0.2690
F	 0.6033	 0.2500
G	 0.0276	 0.0550
H	 0.6393	 0.2910
I	 0.3125	 0.0990
J	 0.8264	 0.3090
K	 0.6459	 0.2500
L	 0.5029	 0.2520
N	 0.7745	 0.1290
P	 0.8113	 0.3380
T	 0.8262	 0.1630
a	 0.7299	 0.1820
b	 0.6903	 0.1770
c	 0.6917	 0.1890
d	 0.7029	 0.1900
e	 0.8153	 0.1620
f	 0.8050	 0.1810
g	 0.6968	 0.1680
h	 0.7613	 0.1660
u	 0.4981	 0.0680

