



wwPDB X-ray Structure Validation Summary Report ⓘ

Jan 4, 2024 – 05:15 pm GMT

PDB ID : 5G2Q
Title : The crystal structure of a S-selective transaminase from *Arthrobacter* sp. with alanine bound
Authors : van Oosterwijk, N.; Willies, S.; Hekelaar, J.; Terwisscha van Scheltinga, A.C.; Turner, N.J.; Dijkstra, B.W.
Deposited on : 2016-04-12
Resolution : 2.30 Å(reported)

This is a wwPDB X-ray Structure Validation Summary Report for a publicly released PDB entry.

We welcome your comments at validation@mail.wwpdb.org

A user guide is available at

<https://www.wwpdb.org/validation/2017/XrayValidationReportHelp>

with specific help available everywhere you see the ⓘ symbol.

The types of validation reports are described at

<http://www.wwpdb.org/validation/2017/FAQs#types>.

The following versions of software and data (see [references ⓘ](#)) were used in the production of this report:

MolProbity : 4.02b-467
Mogul : 1.8.4, CSD as541be (2020)
Xtriage (Phenix) : 1.13
EDS : 2.36
buster-report : 1.1.7 (2018)
Percentile statistics : 20191225.v01 (using entries in the PDB archive December 25th 2019)
Refmac : 5.8.0158
CCP4 : 7.0.044 (Gargrove)
Ideal geometry (proteins) : Engh & Huber (2001)
Ideal geometry (DNA, RNA) : Parkinson et al. (1996)
Validation Pipeline (wwPDB-VP) : 2.36

1 Overall quality at a glance

The following experimental techniques were used to determine the structure:

X-RAY DIFFRACTION



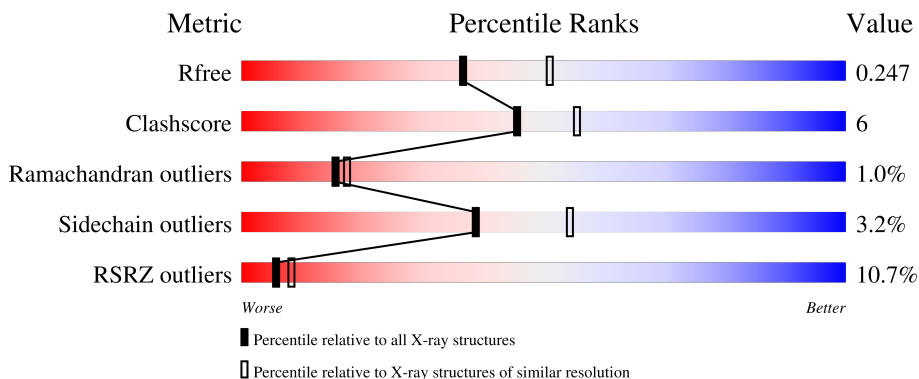

The reported resolution of this entry is 2.30 Å.

Percentile scores (ranging between 0-100) for global validation metrics of the entry are shown in the following graphic. The table shows the number of entries on which the scores are based.



Metric	Whole archive (#Entries)	Similar resolution (#Entries, resolution range(Å))
R_{free}	130704	5042 (2.30-2.30)
Clashscore	141614	5643 (2.30-2.30)
Ramachandran outliers	138981	5575 (2.30-2.30)
Sidechain outliers	138945	5575 (2.30-2.30)
RSRZ outliers	127900	4938 (2.30-2.30)

The table below summarises the geometric issues observed across the polymeric chains and their fit to the electron density. The red, orange, yellow and green segments of the lower bar indicate the fraction of residues that contain outliers for ≥ 3 , 2, 1 and 0 types of geometric quality criteria respectively. A grey segment represents the fraction of residues that are not modelled. The numeric value for each fraction is indicated below the corresponding segment, with a dot representing fractions $\leq 5\%$. The upper red bar (where present) indicates the fraction of residues that have poor fit to the electron density. The numeric value is given above the bar.

Mol	Chain	Length	Quality of chain
1	A	485	 2% 81% 13% 5%
1	B	485	 3% 84% 9% 5%
1	C	485	 3% 80% 14% 5%
1	D	485	 7% 83% 11% 5%

Continued on next page...

Continued from previous page...

Mol	Chain	Length	Quality of chain
1	E	485	<p>7% 80% 14% • 5%</p>
1	F	485	<p>3% 78% 16% • •</p>
1	G	485	<p>7% 82% 12% • 5%</p>
1	H	485	<p>% 81% 13% • 5%</p>
1	I	485	<p>10% 79% 15% • 5%</p>
1	J	485	<p>24% 78% 16% • 5%</p>
1	K	485	<p>25% 72% 21% • 5%</p>
1	L	485	<p>31% 73% 20% • 5%</p>

2 Entry composition [i](#)

There are 3 unique types of molecules in this entry. The entry contains 44561 atoms, of which 0 are hydrogens and 0 are deuteriums.

In the tables below, the ZeroOcc column contains the number of atoms modelled with zero occupancy, the AltConf column contains the number of residues with at least one atom in alternate conformation and the Trace column contains the number of residues modelled with at most 2 atoms.

- Molecule 1 is a protein called TRANSAMINASE.

Mol	Chain	Residues	Atoms					ZeroOcc	AltConf	Trace
			Total	C	N	O	S			
1	A	461	3624	2297	617	692	18	0	0	0
1	B	461	3624	2297	617	692	18	0	0	0
1	C	461	3624	2297	617	692	18	0	0	0
1	D	465	3650	2310	622	700	18	0	0	0
1	E	461	3624	2297	617	692	18	0	0	0
1	F	465	3650	2310	622	700	18	0	0	0
1	G	459	3607	2288	613	688	18	0	0	0
1	H	462	3629	2300	618	693	18	0	0	0
1	I	461	3624	2297	617	692	18	0	0	0
1	J	461	3624	2297	617	692	18	0	0	0
1	K	461	3624	2297	617	692	18	0	0	0
1	L	460	3615	2291	615	691	18	0	0	0

- Molecule 2 is 2-[(3-HYDROXY-2-METHYL-5-PHOSPHONOXYMETHYL-PYRIDIN-4-YLMETHYL)-AMINO]-PROPIONIC ACID (three-letter code: PDA) (formula: $C_{11}H_{17}N_2O_7P$).

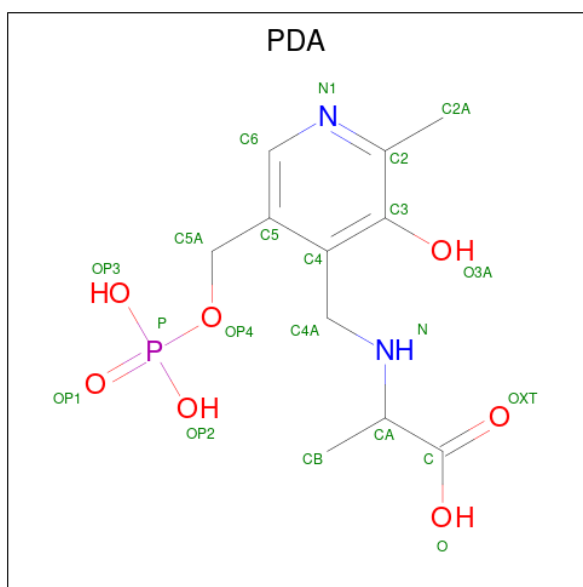

Mol	Chain	Residues	Atoms					ZeroOcc	AltConf
			Total	C	N	O	P		
2	A	1	Total	C	N	O	P	0	0
			21	11	2	7	1		
2	B	1	Total	C	N	O	P	0	0
			21	11	2	7	1		
2	C	1	Total	C	N	O	P	0	0
			21	11	2	7	1		
2	D	1	Total	C	N	O	P	0	0
			21	11	2	7	1		
2	E	1	Total	C	N	O	P	0	0
			21	11	2	7	1		
2	F	1	Total	C	N	O	P	0	0
			21	11	2	7	1		
2	G	1	Total	C	N	O	P	0	0
			21	11	2	7	1		
2	H	1	Total	C	N	O	P	0	0
			21	11	2	7	1		
2	I	1	Total	C	N	O	P	0	0
			21	11	2	7	1		
2	J	1	Total	C	N	O	P	0	0
			21	11	2	7	1		
2	K	1	Total	C	N	O	P	0	0
			21	11	2	7	1		
2	L	1	Total	C	N	O	P	0	0
			21	11	2	7	1		

- Molecule 3 is water.

Mol	Chain	Residues	Atoms	ZeroOcc	AltConf
3	A	162	Total O 162 162	0	0
3	B	110	Total O 110 110	0	0
3	C	80	Total O 80 80	0	0
3	D	66	Total O 66 66	0	0
3	E	63	Total O 63 63	0	0
3	F	64	Total O 64 64	0	0
3	G	90	Total O 90 90	0	0
3	H	74	Total O 74 74	0	0
3	I	38	Total O 38 38	0	0
3	J	17	Total O 17 17	0	0
3	K	12	Total O 12 12	0	0
3	L	14	Total O 14 14	0	0

3 Residue-property plots [i](#)

These plots are drawn for all protein, RNA, DNA and oligosaccharide chains in the entry. The first graphic for a chain summarises the proportions of the various outlier classes displayed in the second graphic. The second graphic shows the sequence view annotated by issues in geometry and electron density. Residues are color-coded according to the number of geometric quality criteria for which they contain at least one outlier: green = 0, yellow = 1, orange = 2 and red = 3 or more. A red dot above a residue indicates a poor fit to the electron density ($RSRZ > 2$). Stretches of 2 or more consecutive residues without any outlier are shown as a green connector. Residues present in the sample, but not in the model, are shown in grey.

- Molecule 1: TRANSAMINASE

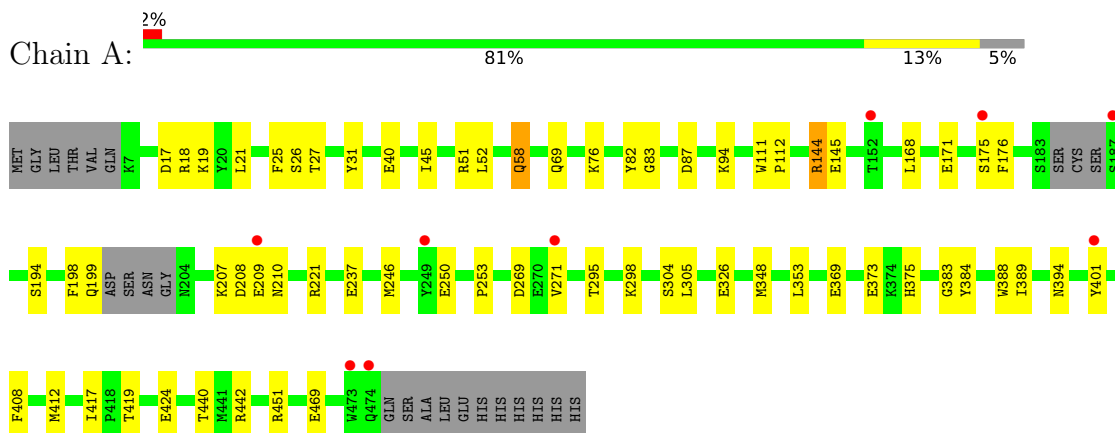

- Molecule 1: TRANSAMINASE

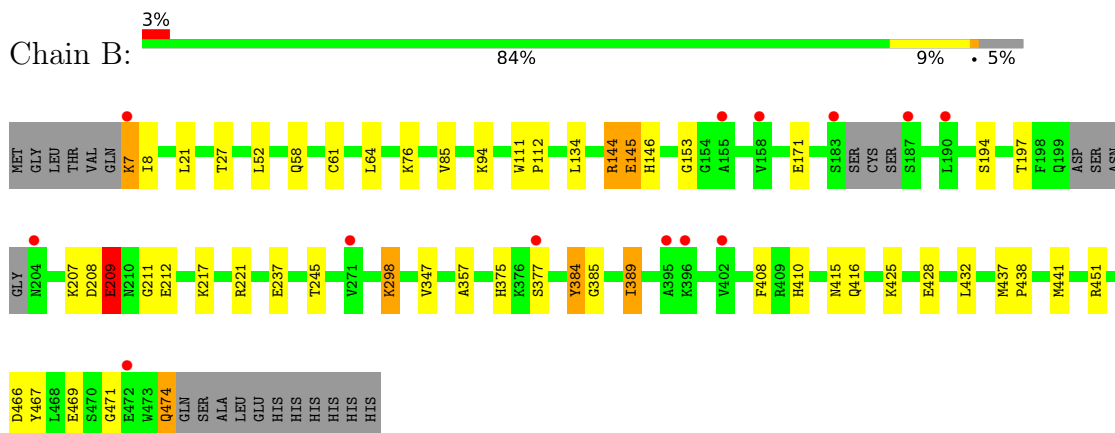

- Molecule 1: TRANSAMINASE

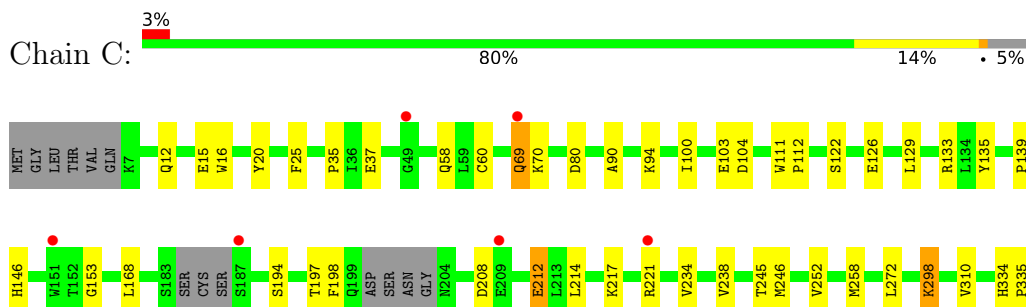

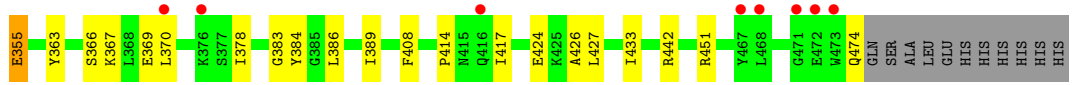

• Molecule 1: TRANSAMINASE

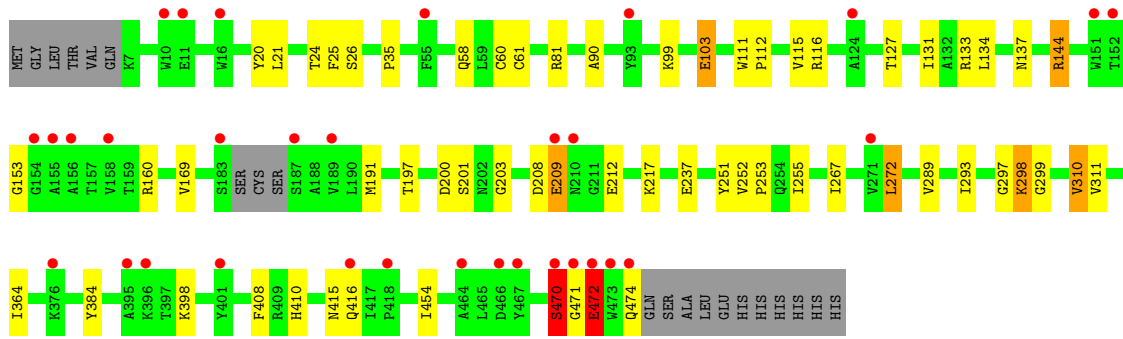
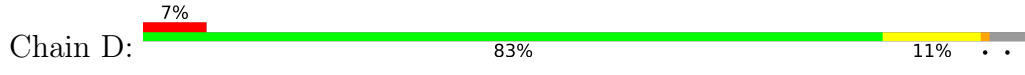

• Molecule 1: TRANSAMINASE

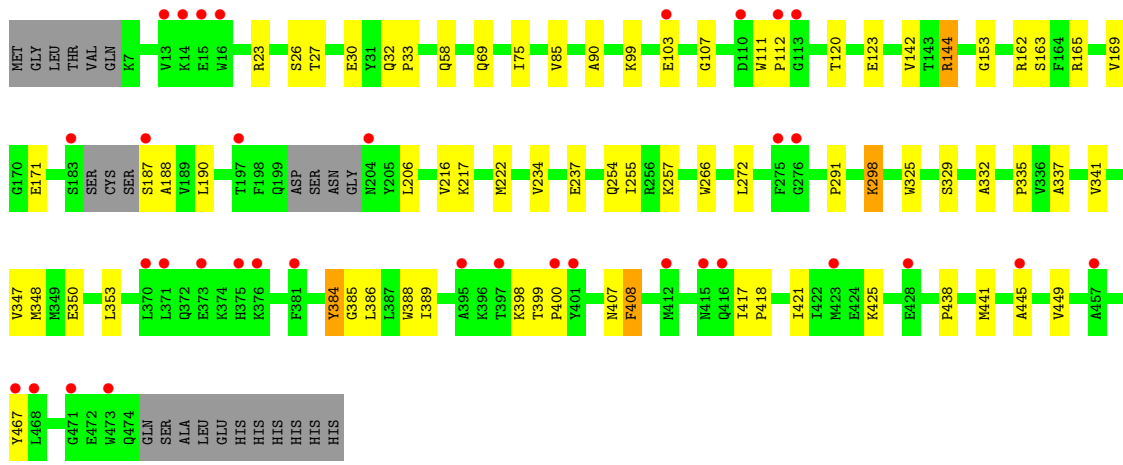
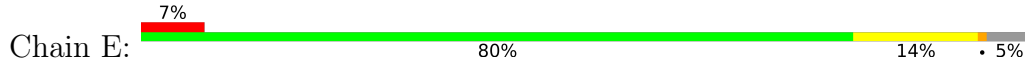

• Molecule 1: TRANSAMINASE

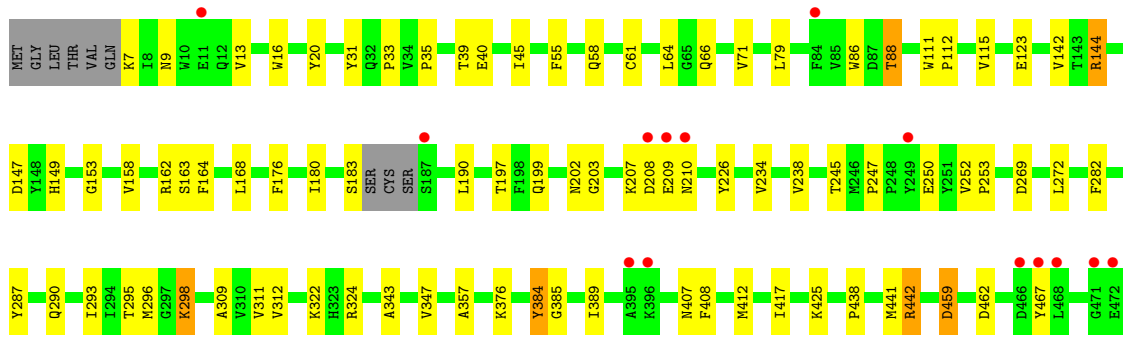
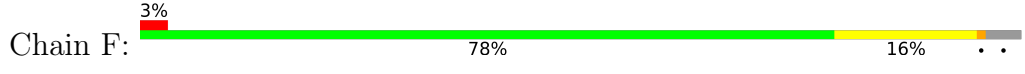

W473
Q474
GLN
SER
ALA
LEU
GLU
HIS
HIS
HIS
HIS
HIS
HIS

● Molecule 1: TRANSAMINASE

Chain G: 7% 82% 12% 5%

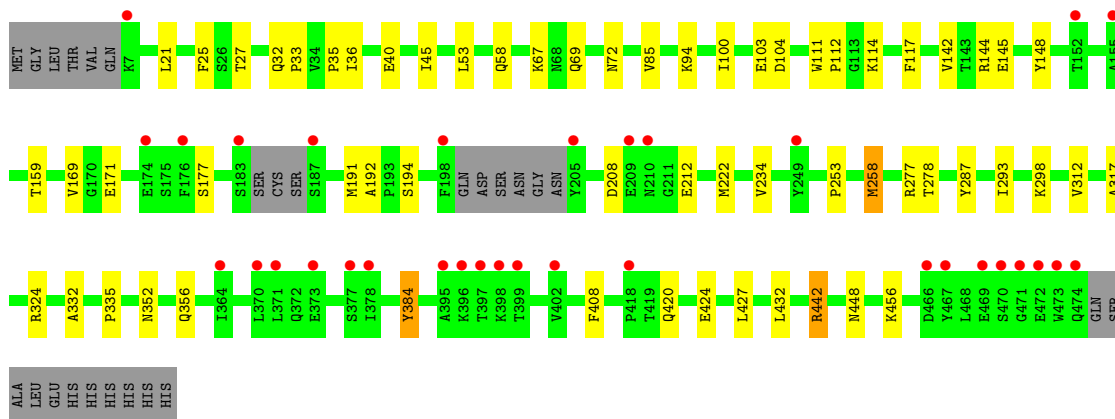

● Molecule 1: TRANSAMINASE

Chain H: 81% 13% 5%

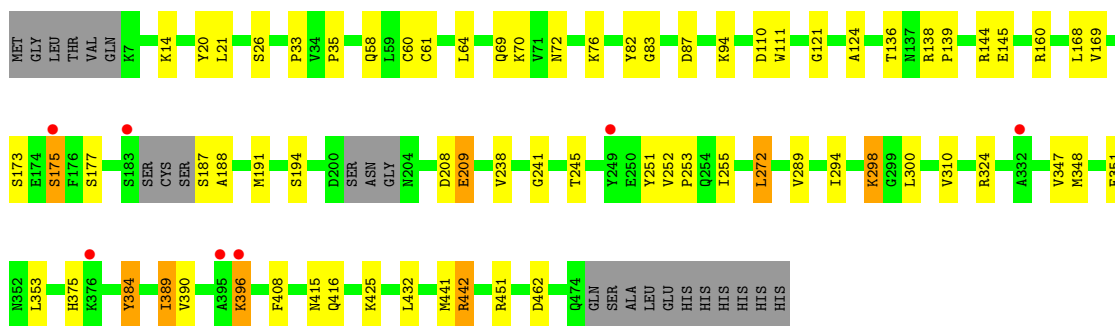

● Molecule 1: TRANSAMINASE

Chain I: 10% 79% 15% 5%

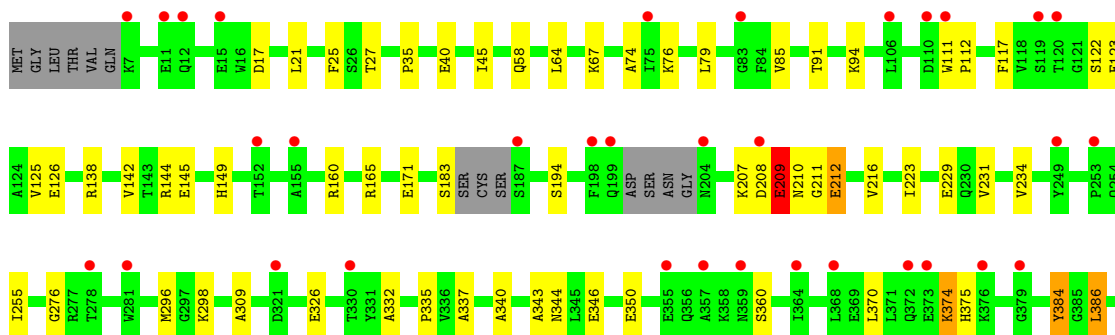



• Molecule 1: TRANSAMINASE

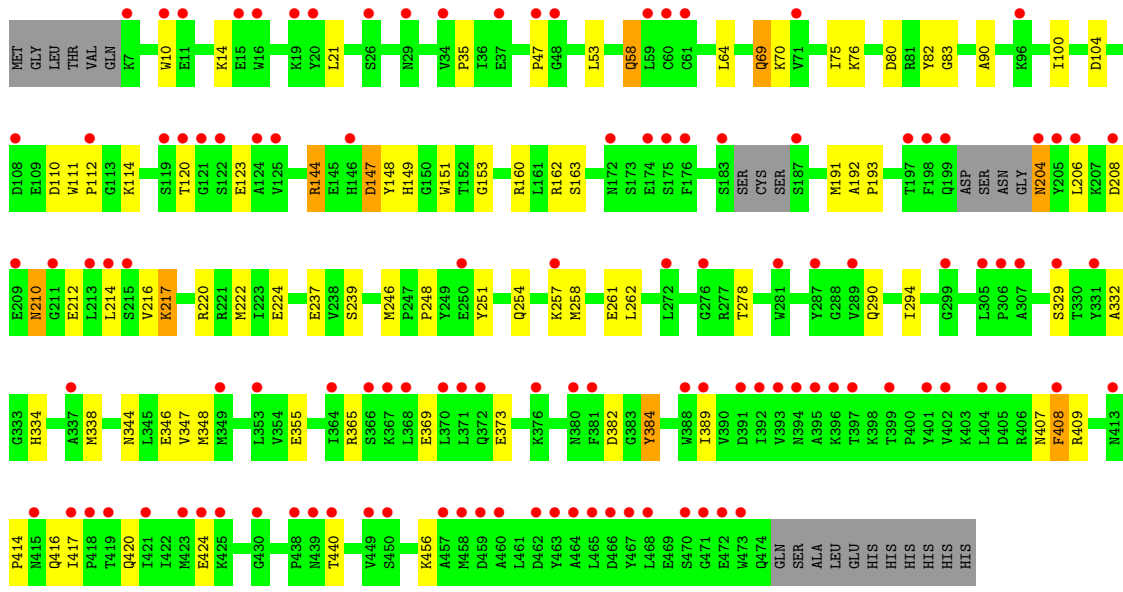
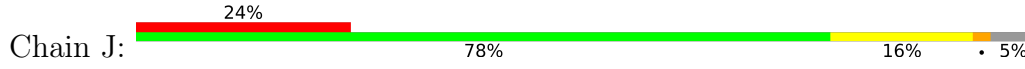

• Molecule 1: TRANSAMINASE

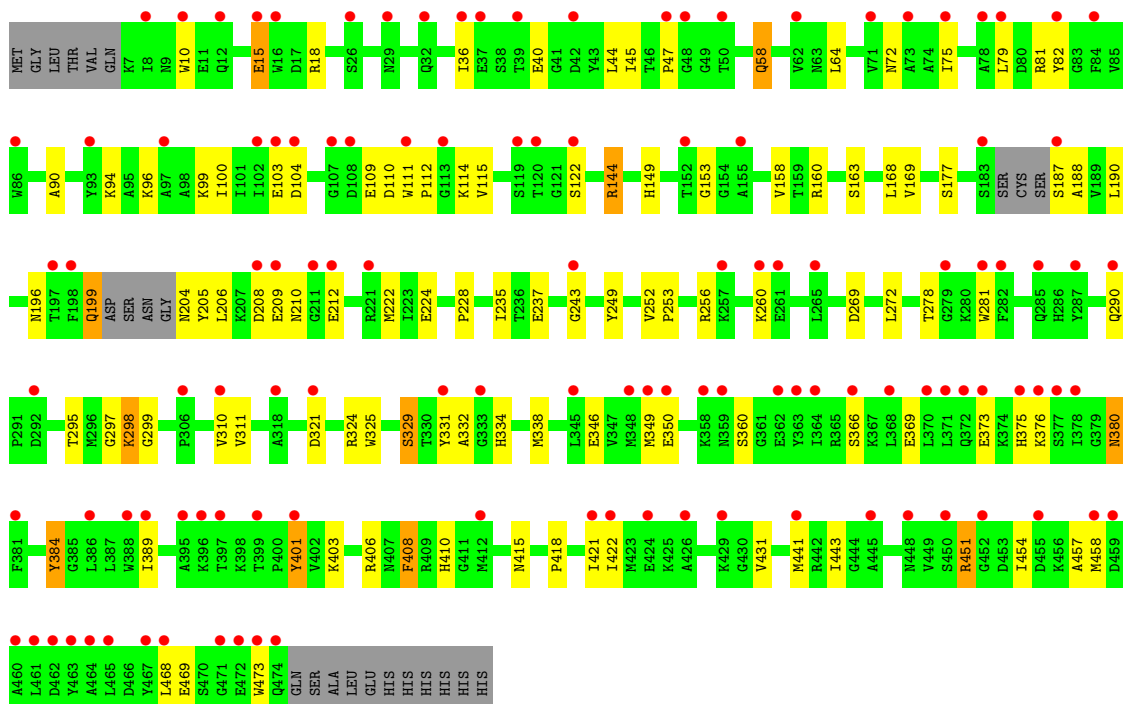

• Molecule 1: TRANSAMINASE

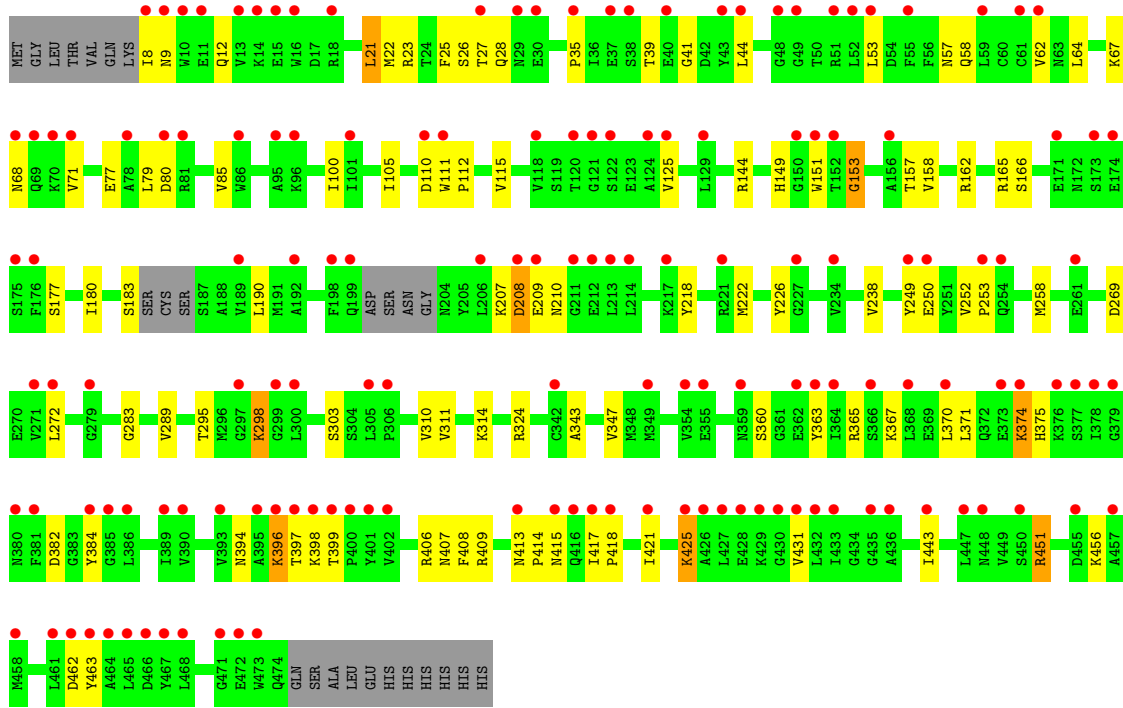
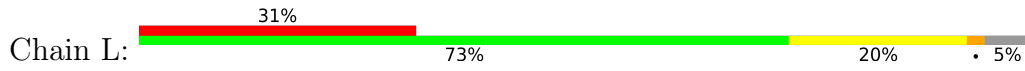

4 Data and refinement statistics

Property	Value	Source
Space group	P 1	Depositor
Cell constants a, b, c, α , β , γ	64.28Å 99.81Å 217.34Å 81.58° 89.12° 74.49°	Depositor
Resolution (Å)	47.96 – 2.30 46.51 – 2.30	Depositor EDS
% Data completeness (in resolution range)	93.7 (47.96-2.30) 93.8 (46.51-2.30)	Depositor EDS
R_{merge}	0.07	Depositor
R_{sym}	(Not available)	Depositor
$\langle I/\sigma(I) \rangle$ ¹	1.87 (at 2.29Å)	Xtrriage
Refinement program	REFMAC 5.8.0073	Depositor
R, R_{free}	0.192 , 0.249 0.184 , 0.247	Depositor DCC
R_{free} test set	10758 reflections (5.02%)	wwPDB-VP
Wilson B-factor (Å ²)	29.6	Xtrriage
Anisotropy	0.900	Xtrriage
Bulk solvent k_{sol} (e/Å ³), B_{sol} (Å ²)	0.34 , 56.7	EDS
L-test for twinning ²	$\langle L \rangle = 0.44$, $\langle L^2 \rangle = 0.26$	Xtrriage
Estimated twinning fraction	No twinning to report.	Xtrriage
F_o, F_c correlation	0.96	EDS
Total number of atoms	44561	wwPDB-VP
Average B, all atoms (Å ²)	74.0	wwPDB-VP

Xtrriage's analysis on translational NCS is as follows: *The largest off-origin peak in the Patterson function is 3.46% of the height of the origin peak. No significant pseudotranslation is detected.*

¹Intensities estimated from amplitudes.

²Theoretical values of $\langle |L| \rangle$, $\langle L^2 \rangle$ for acentric reflections are 0.5, 0.333 respectively for untwinned datasets, and 0.375, 0.2 for perfectly twinned datasets.

5 Model quality i

5.1 Standard geometry i

Bond lengths and bond angles in the following residue types are not validated in this section: PDA

The Z score for a bond length (or angle) is the number of standard deviations the observed value is removed from the expected value. A bond length (or angle) with $|Z| > 5$ is considered an outlier worth inspection. RMSZ is the root-mean-square of all Z scores of the bond lengths (or angles).

Mol	Chain	Bond lengths		Bond angles	
		RMSZ	# Z >5	RMSZ	# Z >5
1	A	0.68	0/3700	0.81	1/5009 (0.0%)
1	B	0.69	0/3700	0.83	0/5009
1	C	0.62	0/3700	0.78	2/5009 (0.0%)
1	D	0.60	0/3727	0.77	1/5047 (0.0%)
1	E	0.59	0/3700	0.74	0/5009
1	F	0.59	0/3727	0.74	0/5047
1	G	0.61	0/3683	0.75	2/4986 (0.0%)
1	H	0.65	0/3705	0.78	1/5016 (0.0%)
1	I	0.53	0/3700	0.71	2/5009 (0.0%)
1	J	0.50	0/3700	0.67	0/5009
1	K	0.48	1/3700 (0.0%)	0.66	0/5009
1	L	0.55	5/3691 (0.1%)	0.71	2/4998 (0.0%)
All	All	0.59	6/44433 (0.0%)	0.75	11/60157 (0.0%)

Chiral center outliers are detected by calculating the chiral volume of a chiral center and verifying if the center is modelled as a planar moiety or with the opposite hand. A planarity outlier is detected by checking planarity of atoms in a peptide group, atoms in a mainchain group or atoms of a sidechain that are expected to be planar.

Mol	Chain	#Chirality outliers	#Planarity outliers
1	B	0	1
1	F	0	1
All	All	0	2

The worst 5 of 6 bond length outliers are listed below:

Mol	Chain	Res	Type	Atoms	Z	Observed(Å)	Ideal(Å)
1	L	443	ILE	C-N	7.92	1.47	1.33
1	L	374	LYS	CB-CG	7.53	1.72	1.52
1	L	425	LYS	CG-CD	6.73	1.75	1.52
1	L	456	LYS	CE-NZ	5.98	1.64	1.49

Continued on next page...

Continued from previous page...

Mol	Chain	Res	Type	Atoms	Z	Observed(Å)	Ideal(Å)
1	L	374	LYS	CD-CE	-5.46	1.37	1.51

The worst 5 of 11 bond angle outliers are listed below:

Mol	Chain	Res	Type	Atoms	Z	Observed(°)	Ideal(°)
1	L	443	ILE	CB-CA-C	-6.57	98.45	111.60
1	L	443	ILE	CA-C-N	-6.07	104.05	116.20
1	D	472	GLU	N-CA-C	-5.84	95.24	111.00
1	C	370	LEU	CA-CB-CG	5.65	128.30	115.30
1	A	18	ARG	NE-CZ-NH2	-5.62	117.49	120.30

There are no chirality outliers.

All (2) planarity outliers are listed below:

Mol	Chain	Res	Type	Group
1	B	207	LYS	Peptide
1	F	176	PHE	Peptide

5.2 Too-close contacts [i](#)

In the following table, the Non-H and H(model) columns list the number of non-hydrogen atoms and hydrogen atoms in the chain respectively. The H(added) column lists the number of hydrogen atoms added and optimized by MolProbity. The Clashes column lists the number of clashes within the asymmetric unit, whereas Symm-Clashes lists symmetry-related clashes.

Mol	Chain	Non-H	H(model)	H(added)	Clashes	Symm-Clashes
1	A	3624	0	3573	41	0
1	B	3624	0	3573	38	0
1	C	3624	0	3573	45	0
1	D	3650	0	3592	43	0
1	E	3624	0	3573	42	0
1	F	3650	0	3592	62	0
1	G	3607	0	3559	38	0
1	H	3629	0	3575	46	0
1	I	3624	0	3573	54	0
1	J	3624	0	3573	52	0
1	K	3624	0	3573	75	0
1	L	3615	0	3560	69	0
2	A	21	0	13	2	0
2	B	21	0	13	3	0
2	C	21	0	13	3	0

Continued on next page...

Continued from previous page...

Mol	Chain	Non-H	H(model)	H(added)	Clashes	Symm-Clashes
2	D	21	0	14	3	0
2	E	21	0	13	0	0
2	F	21	0	14	4	0
2	G	21	0	14	0	0
2	H	21	0	14	0	0
2	I	21	0	14	2	0
2	J	21	0	13	1	0
2	K	21	0	12	2	0
2	L	21	0	12	1	0
3	A	162	0	0	2	0
3	B	110	0	0	2	0
3	C	80	0	0	2	0
3	D	66	0	0	0	0
3	E	63	0	0	0	0
3	F	64	0	0	0	0
3	G	90	0	0	2	0
3	H	74	0	0	2	0
3	I	38	0	0	1	0
3	J	17	0	0	0	0
3	K	12	0	0	0	0
3	L	14	0	0	2	0
All	All	44561	0	43048	552	0

The all-atom clashscore is defined as the number of clashes found per 1000 atoms (including hydrogen atoms). The all-atom clashscore for this structure is 6.

The worst 5 of 552 close contacts within the same asymmetric unit are listed below, sorted by their clash magnitude.

Atom-1	Atom-2	Interatomic distance (Å)	Clash overlap (Å)
1:L:425:LYS:CD	1:L:425:LYS:CG	1.75	1.58
1:H:208:ASP:O	1:H:209:GLU:HG2	1.41	1.19
1:L:8:ILE:HG22	1:L:9:ASN:H	1.12	1.11
3:A:2078:HOH:O	1:C:221:ARG:HD3	1.64	0.95
1:G:192:ALA:HA	1:G:222:MET:HE1	1.53	0.91

There are no symmetry-related clashes.

5.3 Torsion angles [i](#)

5.3.1 Protein backbone [i](#)

In the following table, the Percentiles column shows the percent Ramachandran outliers of the chain as a percentile score with respect to all X-ray entries followed by that with respect to entries of similar resolution.

The Analysed column shows the number of residues for which the backbone conformation was analysed, and the total number of residues.

Mol	Chain	Analysed	Favoured	Allowed	Outliers	Percentiles	
1	A	455/485 (94%)	429 (94%)	22 (5%)	4 (1%)	17	20
1	B	455/485 (94%)	429 (94%)	22 (5%)	4 (1%)	17	20
1	C	455/485 (94%)	428 (94%)	22 (5%)	5 (1%)	14	15
1	D	461/485 (95%)	429 (93%)	26 (6%)	6 (1%)	12	12
1	E	455/485 (94%)	430 (94%)	21 (5%)	4 (1%)	17	20
1	F	461/485 (95%)	435 (94%)	23 (5%)	3 (1%)	22	26
1	G	453/485 (93%)	430 (95%)	20 (4%)	3 (1%)	22	26
1	H	456/485 (94%)	434 (95%)	18 (4%)	4 (1%)	17	20
1	I	455/485 (94%)	421 (92%)	30 (7%)	4 (1%)	17	20
1	J	455/485 (94%)	422 (93%)	31 (7%)	2 (0%)	34	42
1	K	455/485 (94%)	420 (92%)	30 (7%)	5 (1%)	14	15
1	L	454/485 (94%)	419 (92%)	27 (6%)	8 (2%)	8	7
All	All	5470/5820 (94%)	5126 (94%)	292 (5%)	52 (1%)	15	17

5 of 52 Ramachandran outliers are listed below:

Mol	Chain	Res	Type
1	K	153	GLY
1	K	209	GLU
1	A	87	ASP
1	B	209	GLU
1	D	153	GLY

5.3.2 Protein sidechains [i](#)

In the following table, the Percentiles column shows the percent sidechain outliers of the chain as a percentile score with respect to all X-ray entries followed by that with respect to entries of similar resolution.

The Analysed column shows the number of residues for which the sidechain conformation was analysed, and the total number of residues.

Mol	Chain	Analysed	Rotameric	Outliers	Percentiles	
1	A	388/409 (95%)	375 (97%)	13 (3%)	37	51
1	B	388/409 (95%)	378 (97%)	10 (3%)	46	63
1	C	388/409 (95%)	374 (96%)	14 (4%)	35	49
1	D	391/409 (96%)	378 (97%)	13 (3%)	38	53
1	E	388/409 (95%)	378 (97%)	10 (3%)	46	63
1	F	391/409 (96%)	381 (97%)	10 (3%)	46	63
1	G	386/409 (94%)	378 (98%)	8 (2%)	53	70
1	H	388/409 (95%)	372 (96%)	16 (4%)	30	43
1	I	388/409 (95%)	379 (98%)	9 (2%)	50	67
1	J	388/409 (95%)	370 (95%)	18 (5%)	27	38
1	K	388/409 (95%)	371 (96%)	17 (4%)	28	39
1	L	387/409 (95%)	374 (97%)	13 (3%)	37	51
All	All	4659/4908 (95%)	4508 (97%)	151 (3%)	39	54

5 of 151 residues with a non-rotameric sidechain are listed below:

Mol	Chain	Res	Type
1	J	373	GLU
1	L	310	VAL
1	J	416	GLN
1	K	373	GLU
1	L	451	ARG

Sometimes sidechains can be flipped to improve hydrogen bonding and reduce clashes. 5 of 30 such sidechains are listed below:

Mol	Chain	Res	Type
1	F	202	ASN
1	K	380	ASN
1	G	69	GLN
1	L	372	GLN
1	I	196	ASN

5.3.3 RNA

There are no RNA molecules in this entry.

5.4 Non-standard residues in protein, DNA, RNA chains [i](#)

There are no non-standard protein/DNA/RNA residues in this entry.

5.5 Carbohydrates [i](#)

There are no monosaccharides in this entry.

5.6 Ligand geometry [i](#)

12 ligands are modelled in this entry.

In the following table, the Counts columns list the number of bonds (or angles) for which Mogul statistics could be retrieved, the number of bonds (or angles) that are observed in the model and the number of bonds (or angles) that are defined in the Chemical Component Dictionary. The Link column lists molecule types, if any, to which the group is linked. The Z score for a bond length (or angle) is the number of standard deviations the observed value is removed from the expected value. A bond length (or angle) with $|Z| > 2$ is considered an outlier worth inspection. RMSZ is the root-mean-square of all Z scores of the bond lengths (or angles).

Mol	Type	Chain	Res	Link	Bond lengths			Bond angles		
					Counts	RMSZ	# Z > 2	Counts	RMSZ	# Z > 2
2	PDA	E	1000	-	20,21,21	2.47	2 (10%)	26,30,30	1.43	3 (11%)
2	PDA	I	1000	-	20,21,21	2.40	2 (10%)	26,30,30	1.64	6 (23%)
2	PDA	A	1000	-	20,21,21	2.34	2 (10%)	26,30,30	1.32	3 (11%)
2	PDA	L	1000	-	20,21,21	2.63	3 (15%)	26,30,30	1.53	4 (15%)
2	PDA	G	1000	-	20,21,21	2.27	3 (15%)	26,30,30	1.51	5 (19%)
2	PDA	D	1000	-	20,21,21	2.21	3 (15%)	26,30,30	1.69	6 (23%)
2	PDA	J	1000	-	20,21,21	2.30	2 (10%)	26,30,30	1.27	1 (3%)
2	PDA	H	1000	-	20,21,21	2.56	2 (10%)	26,30,30	1.68	4 (15%)
2	PDA	B	1000	-	20,21,21	2.22	3 (15%)	26,30,30	1.59	7 (26%)
2	PDA	C	1000	-	20,21,21	2.38	3 (15%)	26,30,30	1.43	4 (15%)
2	PDA	K	1000	-	20,21,21	2.29	2 (10%)	26,30,30	1.43	4 (15%)
2	PDA	F	1000	-	20,21,21	2.60	2 (10%)	26,30,30	1.44	2 (7%)

In the following table, the Chirals column lists the number of chiral outliers, the number of chiral centers analysed, the number of these observed in the model and the number defined in the Chemical Component Dictionary. Similar counts are reported in the Torsion and Rings columns. '2' means no outliers of that kind were identified.

Mol	Type	Chain	Res	Link	Chirals	Torsions	Rings
2	PDA	E	1000	-	-	8/15/15/15	0/1/1/1
2	PDA	I	1000	-	-	7/15/15/15	0/1/1/1
2	PDA	A	1000	-	-	5/15/15/15	0/1/1/1
2	PDA	L	1000	-	-	6/15/15/15	0/1/1/1
2	PDA	G	1000	-	-	7/15/15/15	0/1/1/1
2	PDA	D	1000	-	-	3/15/15/15	0/1/1/1
2	PDA	J	1000	-	-	6/15/15/15	0/1/1/1
2	PDA	H	1000	-	-	6/15/15/15	0/1/1/1
2	PDA	B	1000	-	-	6/15/15/15	0/1/1/1
2	PDA	C	1000	-	-	6/15/15/15	0/1/1/1
2	PDA	K	1000	-	-	6/15/15/15	0/1/1/1
2	PDA	F	1000	-	-	7/15/15/15	0/1/1/1

The worst 5 of 29 bond length outliers are listed below:

Mol	Chain	Res	Type	Atoms	Z	Observed(Å)	Ideal(Å)
2	F	1000	PDA	C3-C2	9.12	1.50	1.40
2	H	1000	PDA	C3-C2	8.66	1.49	1.40
2	E	1000	PDA	C3-C2	8.30	1.49	1.40
2	I	1000	PDA	C3-C2	7.77	1.48	1.40
2	L	1000	PDA	C3-C2	7.71	1.48	1.40

The worst 5 of 49 bond angle outliers are listed below:

Mol	Chain	Res	Type	Atoms	Z	Observed(°)	Ideal(°)
2	H	1000	PDA	C6-C5-C4	5.02	121.67	118.12
2	I	1000	PDA	C4-C4A-N	4.23	123.42	111.78
2	L	1000	PDA	OP4-C5A-C5	3.98	116.93	109.35
2	F	1000	PDA	C4-C4A-N	3.67	121.88	111.78
2	G	1000	PDA	C4-C4A-N	3.62	121.76	111.78

There are no chirality outliers.

5 of 73 torsion outliers are listed below:

Mol	Chain	Res	Type	Atoms
2	A	1000	PDA	C5-C4-C4A-N
2	B	1000	PDA	C-CA-N-C4A
2	C	1000	PDA	CB-CA-N-C4A
2	C	1000	PDA	C-CA-N-C4A
2	D	1000	PDA	CB-CA-N-C4A

There are no ring outliers.

9 monomers are involved in 21 short contacts:

Mol	Chain	Res	Type	Clashes	Symm-Clashes
2	I	1000	PDA	2	0
2	A	1000	PDA	2	0
2	L	1000	PDA	1	0
2	D	1000	PDA	3	0
2	J	1000	PDA	1	0
2	B	1000	PDA	3	0
2	C	1000	PDA	3	0
2	K	1000	PDA	2	0
2	F	1000	PDA	4	0

The following is a two-dimensional graphical depiction of Mogul quality analysis of bond lengths, bond angles, torsion angles, and ring geometry for all instances of the Ligand of Interest. In addition, ligands with molecular weight > 250 and outliers as shown on the validation Tables will also be included. For torsion angles, if less than 5% of the Mogul distribution of torsion angles is within 10 degrees of the torsion angle in question, then that torsion angle is considered an outlier. Any bond that is central to one or more torsion angles identified as an outlier by Mogul will be highlighted in the graph. For rings, the root-mean-square deviation (RMSD) between the ring in question and similar rings identified by Mogul is calculated over all ring torsion angles. If the average RMSD is greater than 60 degrees and the minimal RMSD between the ring in question and any Mogul-identified rings is also greater than 60 degrees, then that ring is considered an outlier. The outliers are highlighted in purple. The color gray indicates Mogul did not find sufficient equivalents in the CSD to analyse the geometry.

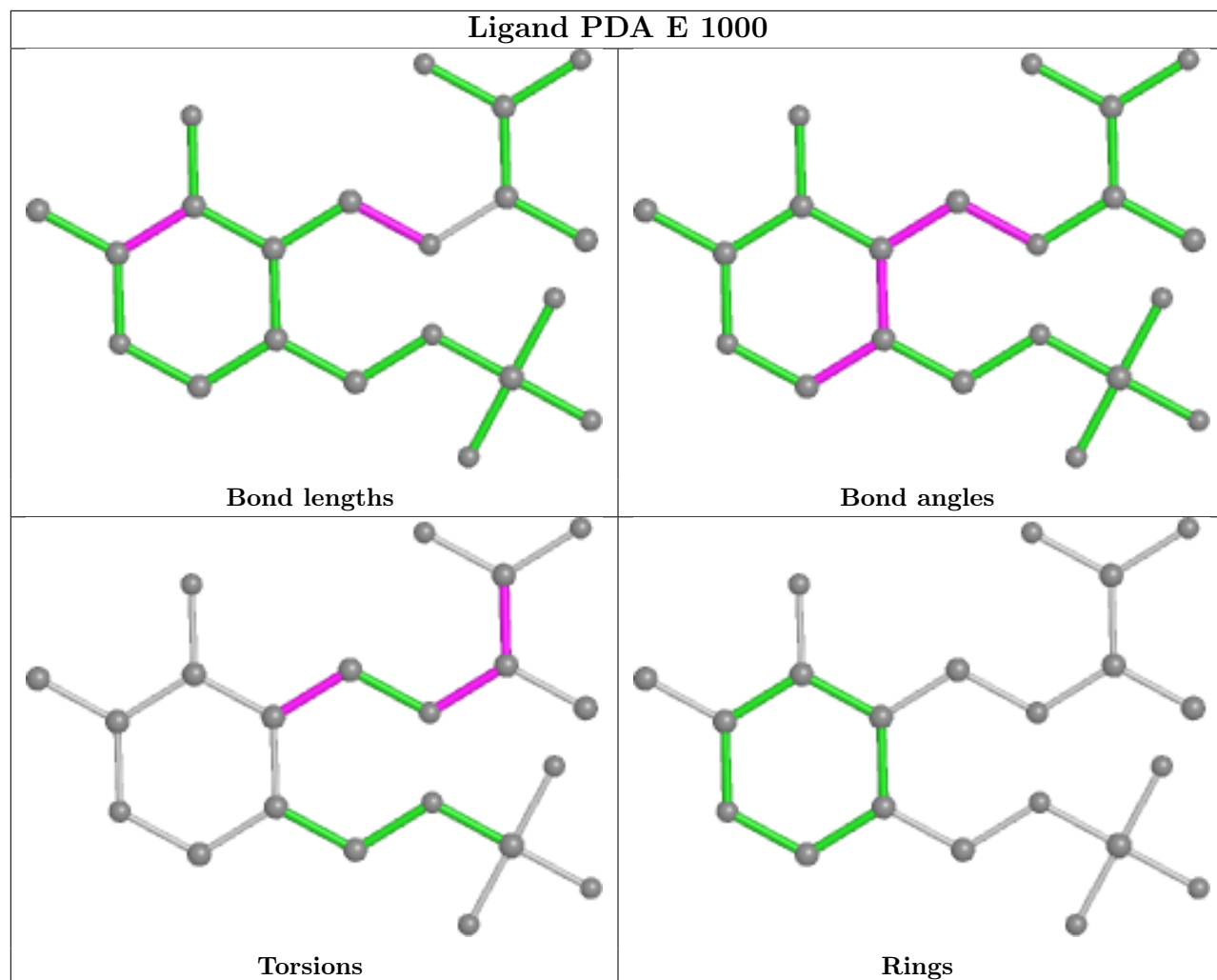

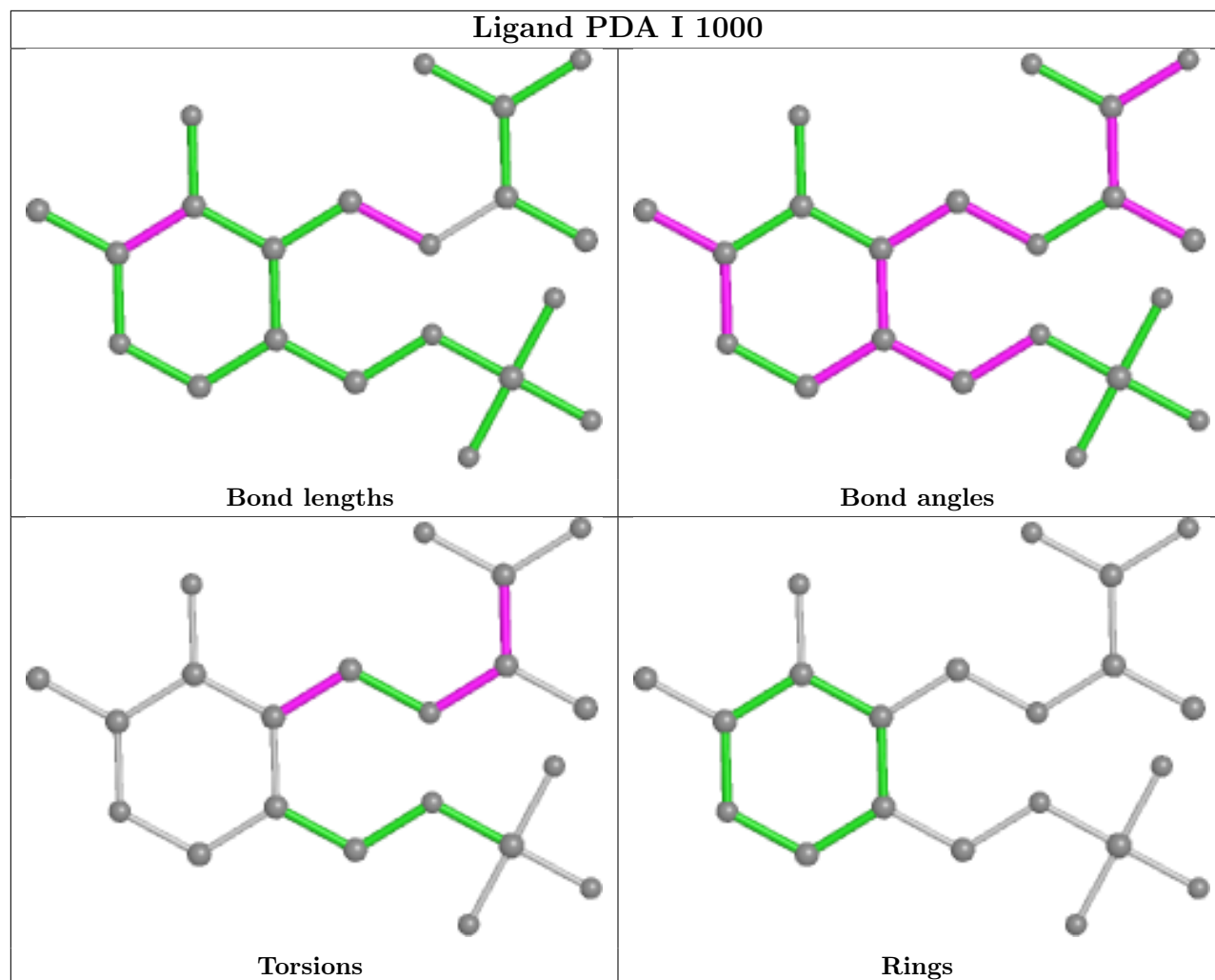

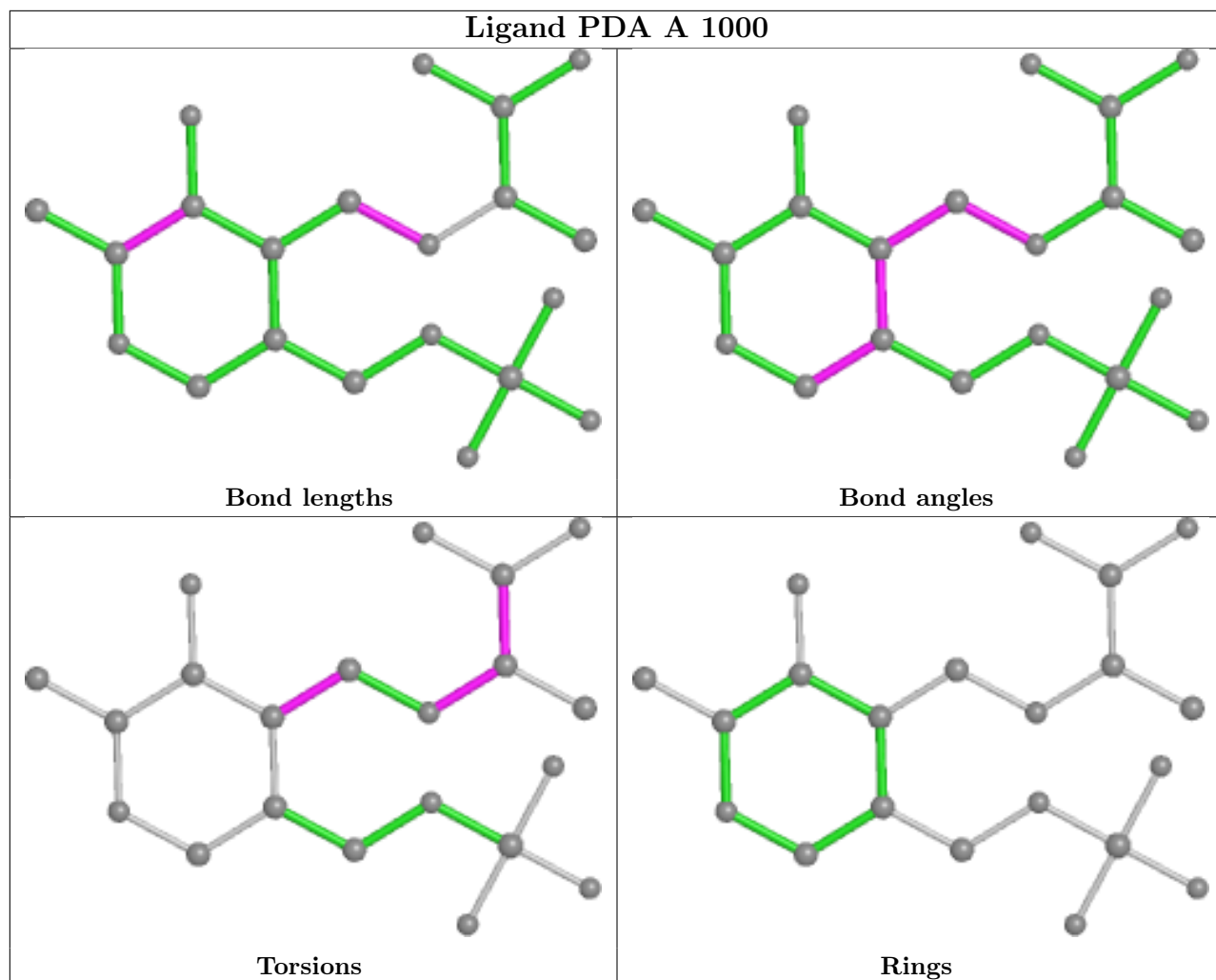

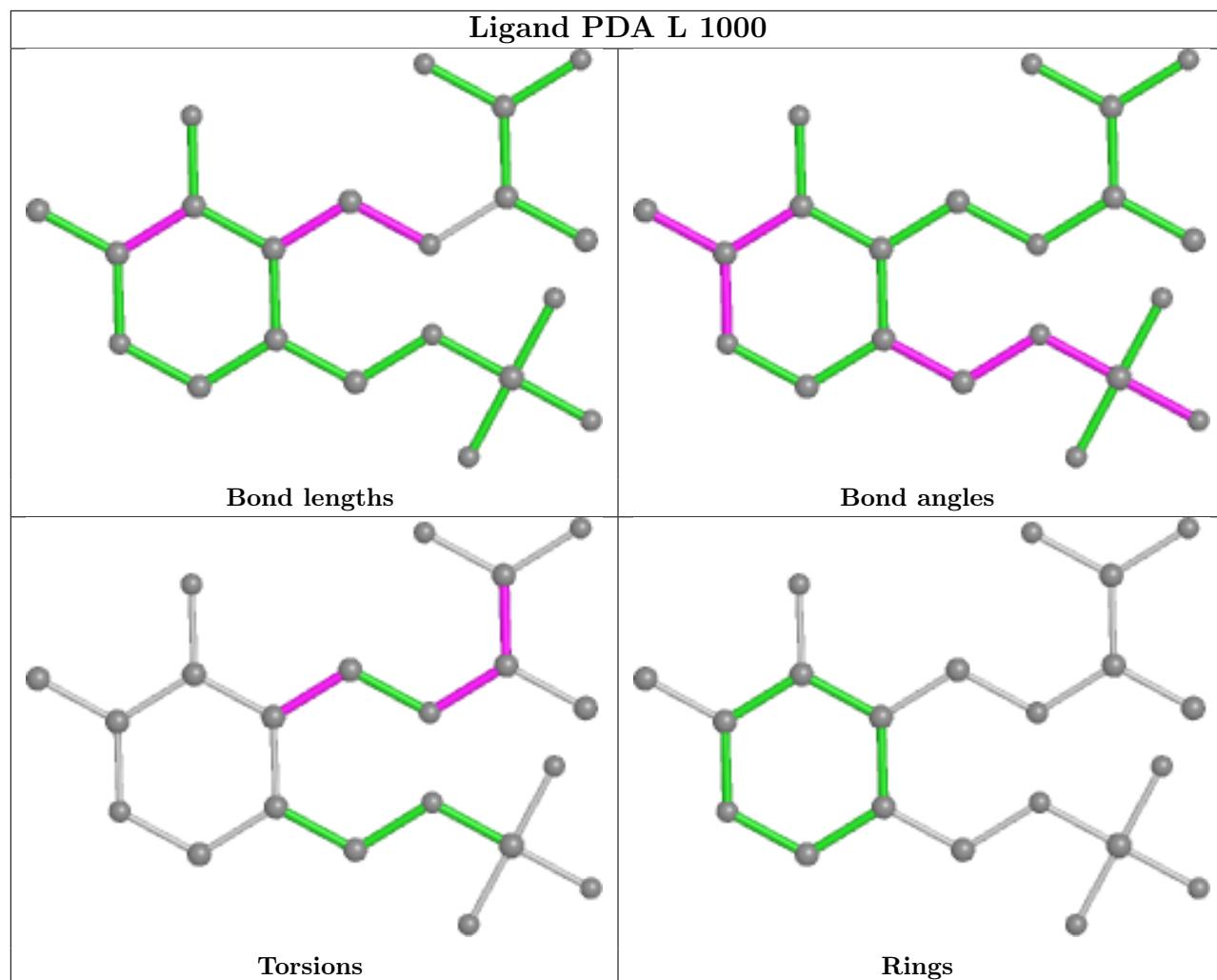

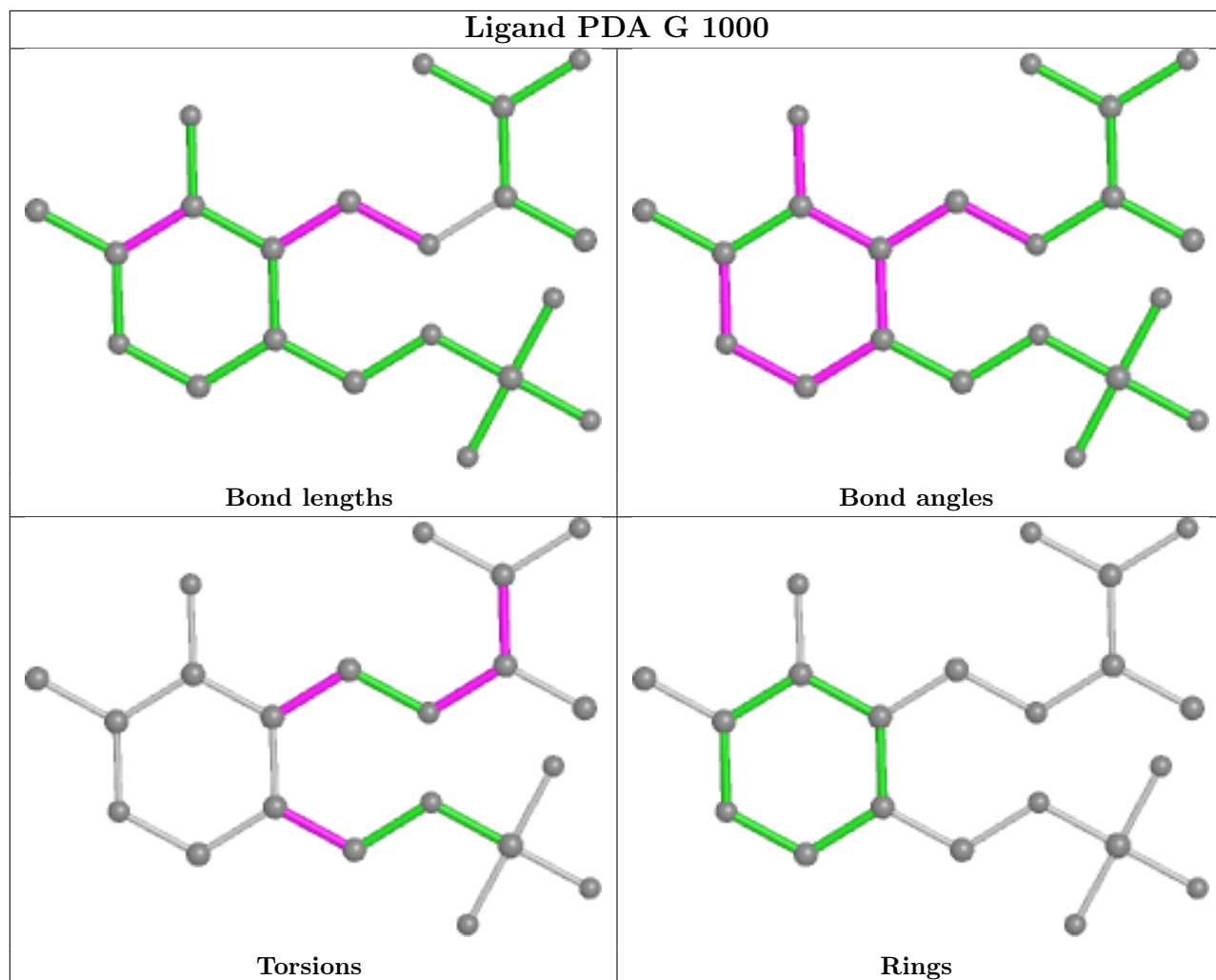

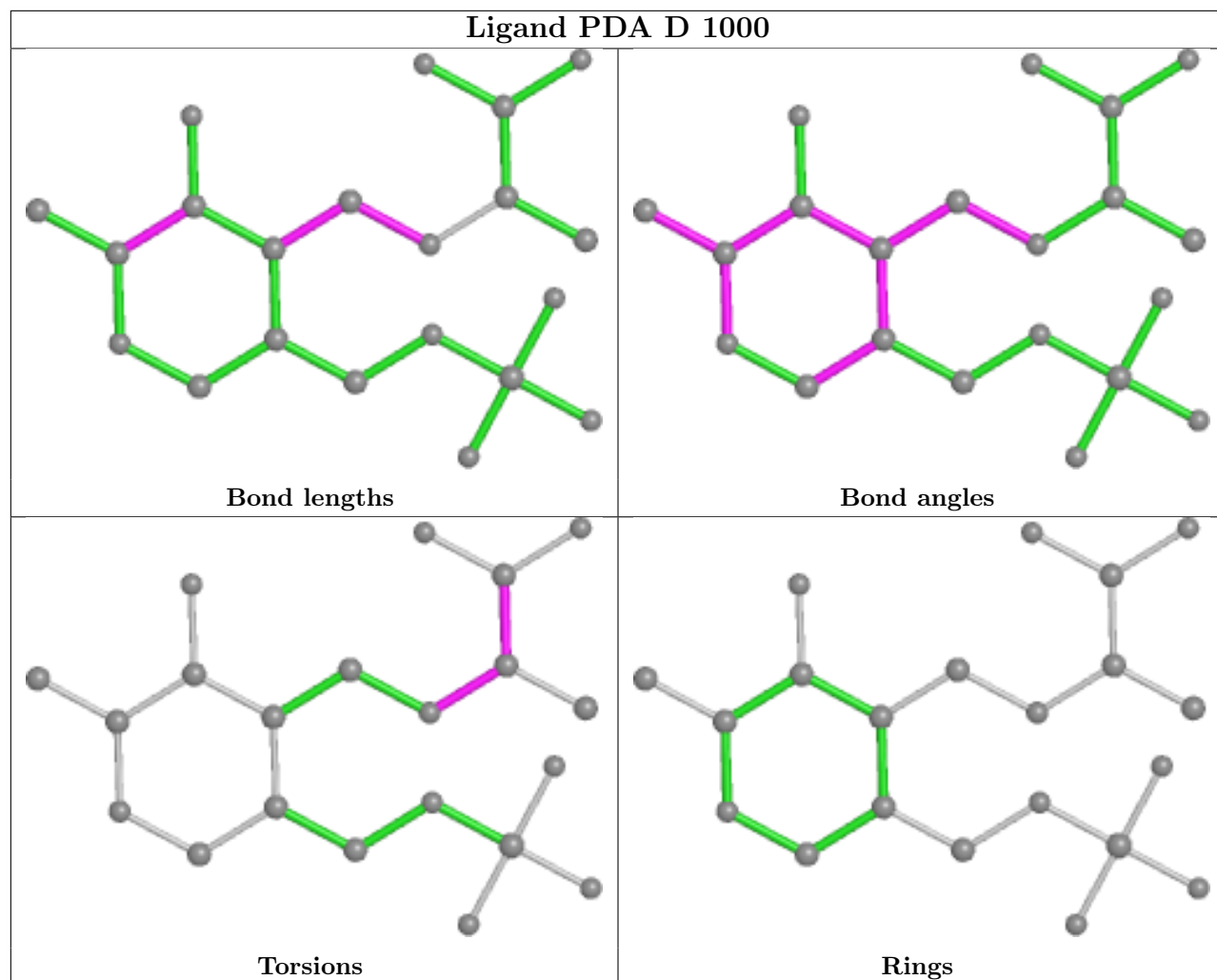

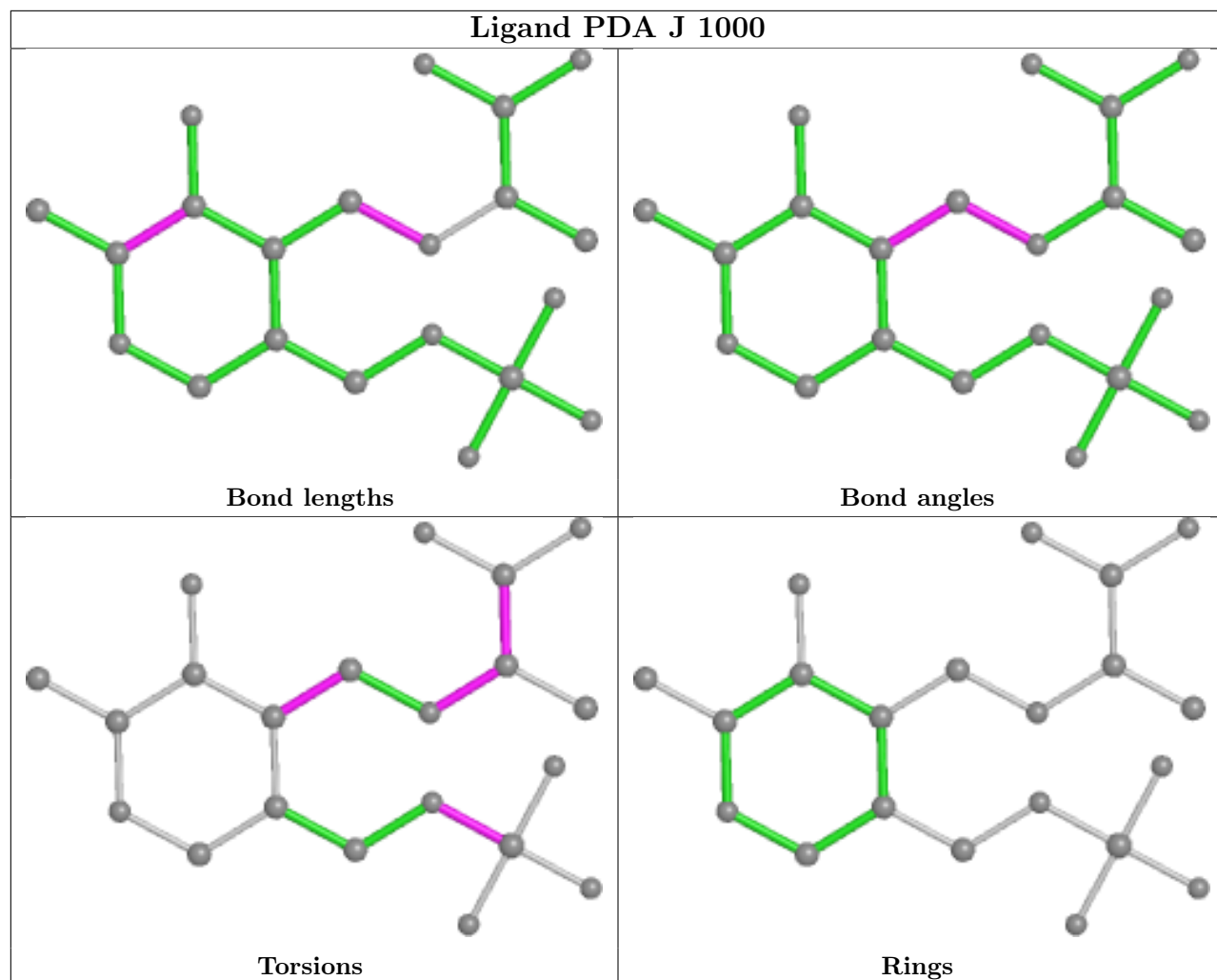

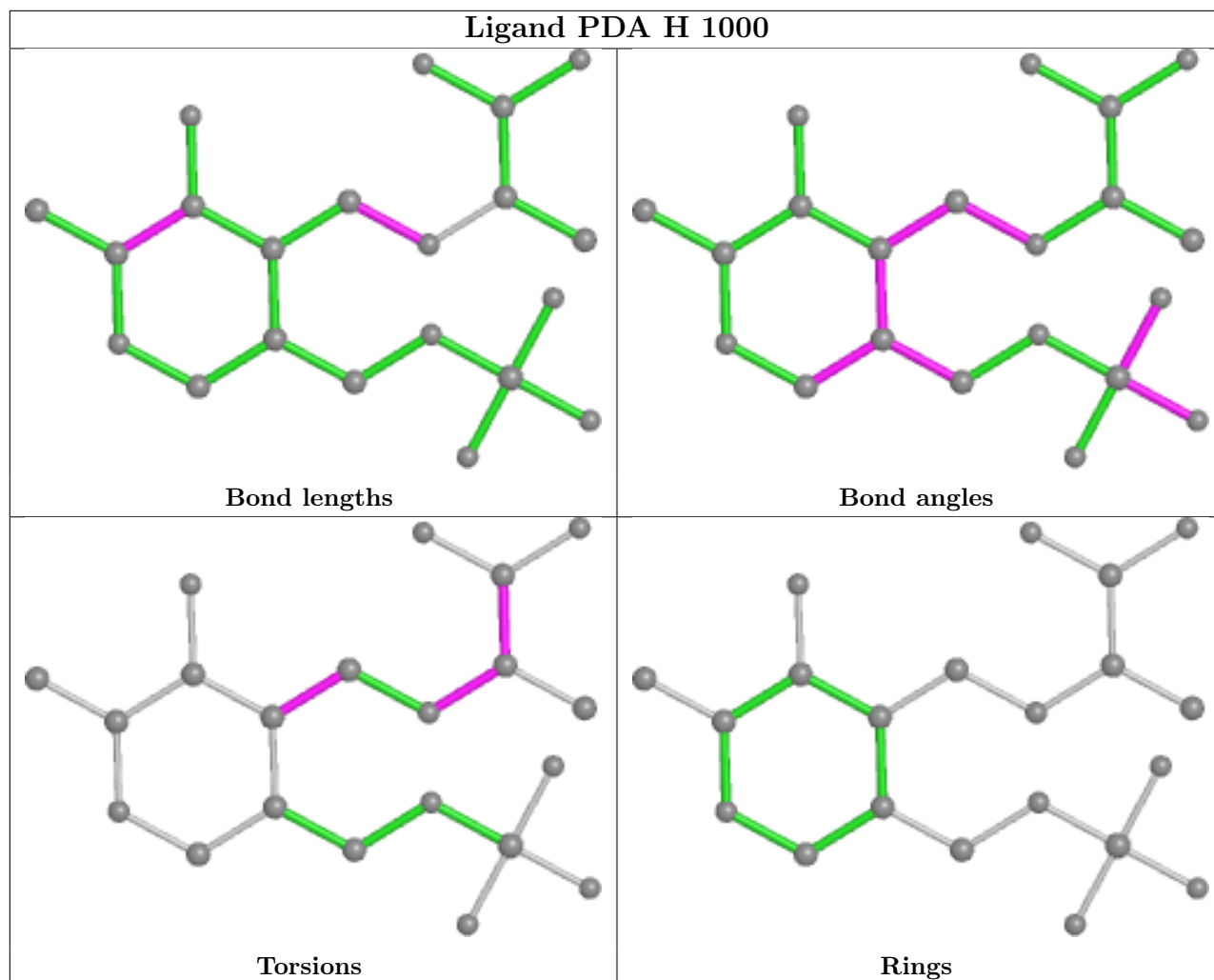

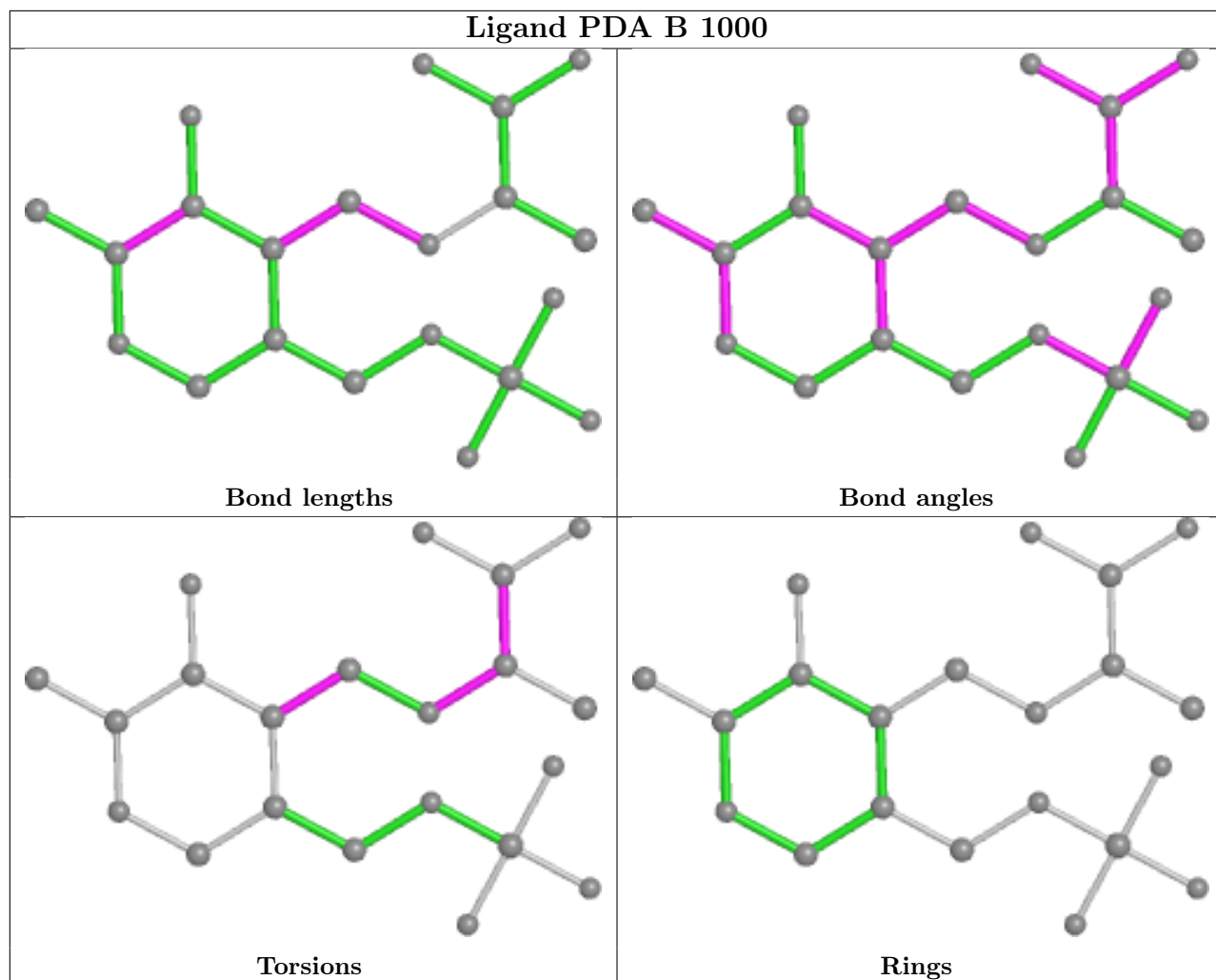

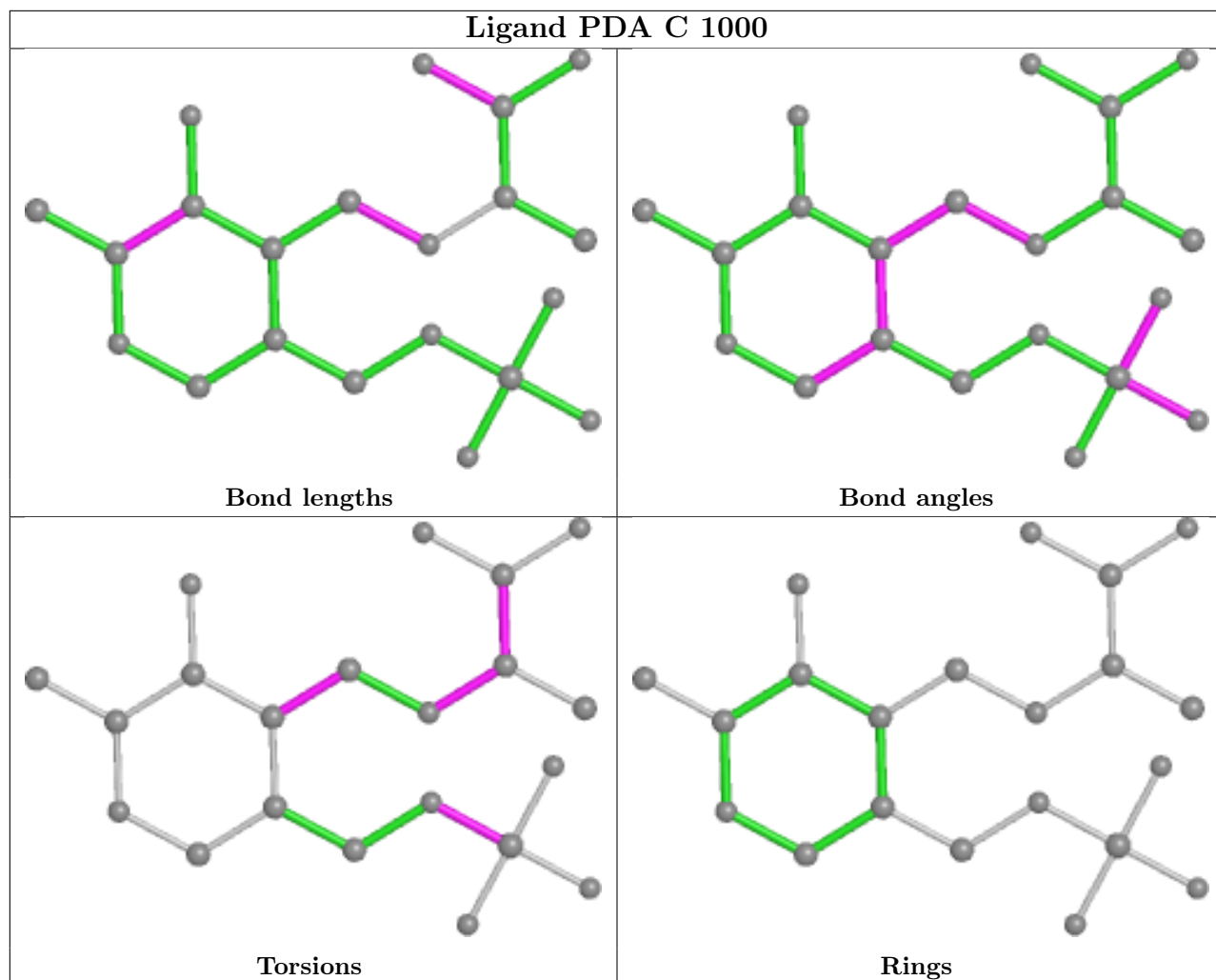

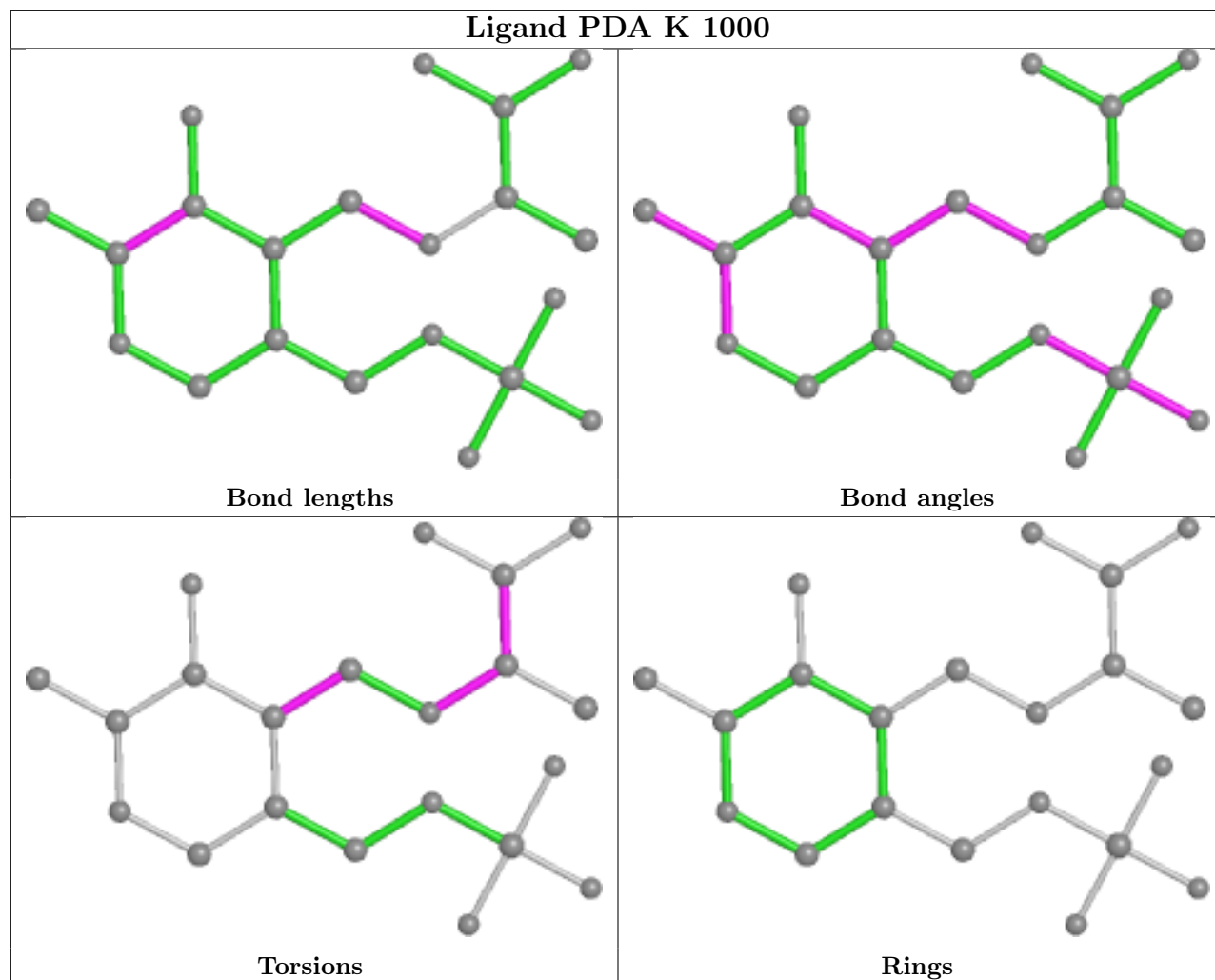

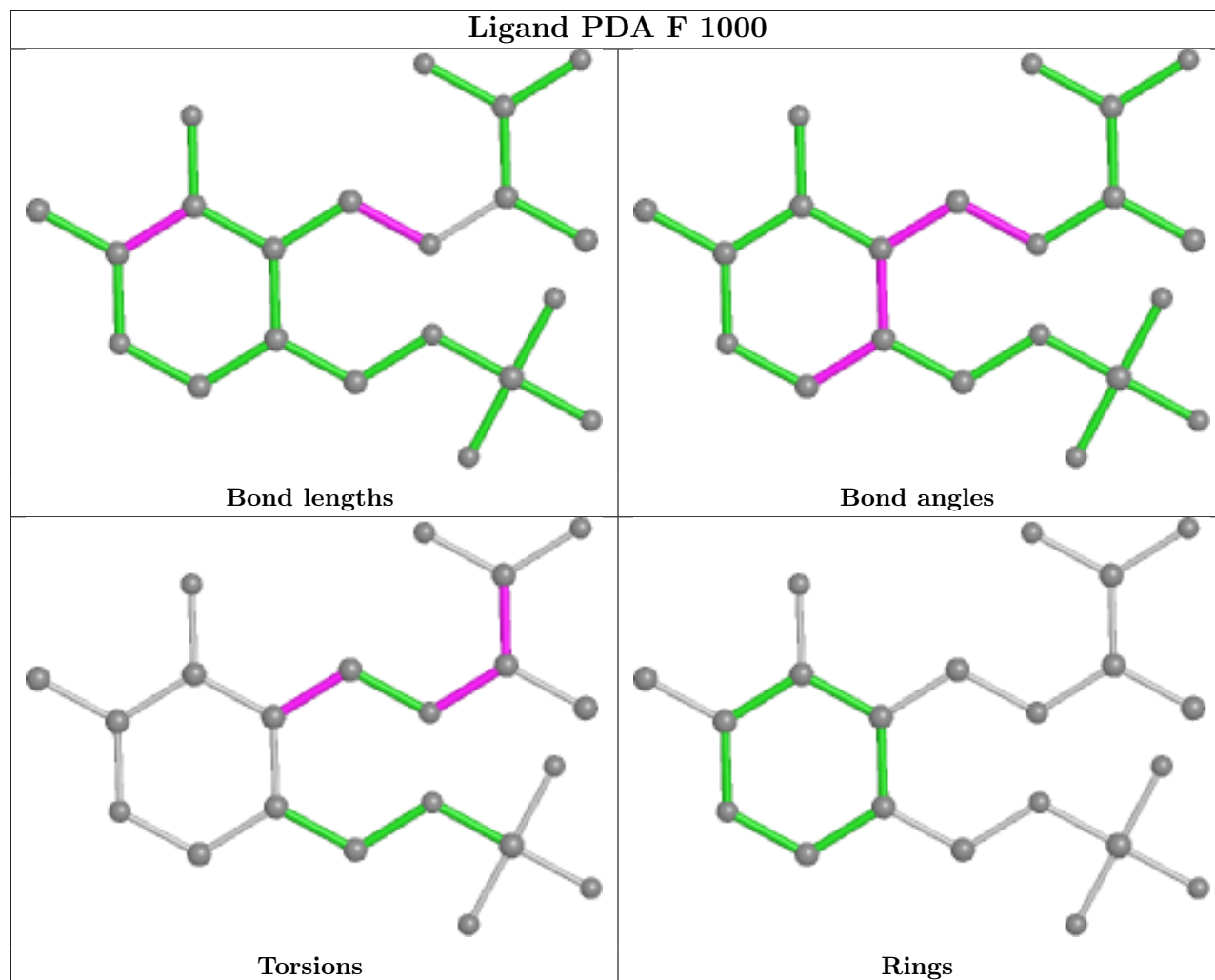

5.7 Other polymers [i](#)

There are no such residues in this entry.

5.8 Polymer linkage issues [i](#)

There are no chain breaks in this entry.

6 Fit of model and data [i](#)

6.1 Protein, DNA and RNA chains [i](#)

In the following table, the column labelled ‘#RSRZ > 2’ contains the number (and percentage) of RSRZ outliers, followed by percent RSRZ outliers for the chain as percentile scores relative to all X-ray entries and entries of similar resolution. The OWAB column contains the minimum, median, 95th percentile and maximum values of the occupancy-weighted average B-factor per residue. The column labelled ‘Q < 0.9’ lists the number of (and percentage) of residues with an average occupancy less than 0.9.

Mol	Chain	Analysed	<RSRZ>	#RSRZ>2	OWAB(Å ²)	Q<0.9
1	A	461/485 (95%)	0.24	9 (1%) 65 71	45, 55, 75, 94	0
1	B	461/485 (95%)	0.39	13 (2%) 53 60	43, 56, 74, 97	0
1	C	461/485 (95%)	0.38	14 (3%) 50 57	49, 63, 81, 96	0
1	D	465/485 (95%)	0.55	32 (6%) 16 22	48, 63, 84, 116	0
1	E	461/485 (95%)	0.63	35 (7%) 13 18	53, 72, 91, 107	0
1	F	465/485 (95%)	0.40	15 (3%) 47 54	51, 68, 88, 114	0
1	G	459/485 (94%)	0.54	33 (7%) 15 20	49, 64, 87, 118	0
1	H	462/485 (95%)	0.32	7 (1%) 73 79	47, 61, 81, 98	0
1	I	461/485 (95%)	0.74	47 (10%) 6 9	52, 77, 101, 127	0
1	J	461/485 (95%)	1.36	116 (25%) 0 0	59, 86, 114, 133	0
1	K	461/485 (95%)	1.35	119 (25%) 0 0	57, 96, 136, 163	0
1	L	460/485 (94%)	1.81	152 (33%) 0 0	63, 110, 164, 185	0
All	All	5538/5820 (95%)	0.73	592 (10%) 6 8	43, 69, 119, 185	0

The worst 5 of 592 RSRZ outliers are listed below:

Mol	Chain	Res	Type	RSRZ
1	L	473	TRP	14.7
1	L	399	THR	10.6
1	L	8	ILE	10.4
1	L	48	GLY	10.4
1	L	366	SER	8.6

6.2 Non-standard residues in protein, DNA, RNA chains [i](#)

There are no non-standard protein/DNA/RNA residues in this entry.

6.3 Carbohydrates [i](#)

There are no monosaccharides in this entry.

6.4 Ligands [i](#)

In the following table, the Atoms column lists the number of modelled atoms in the group and the number defined in the chemical component dictionary. The B-factors column lists the minimum, median, 95th percentile and maximum values of B factors of atoms in the group. The column labelled 'Q< 0.9' lists the number of atoms with occupancy less than 0.9.

Mol	Type	Chain	Res	Atoms	RSCC	RSR	B-factors(\AA^2)	Q<0.9
2	PDA	J	1000	21/21	0.91	0.22	68,74,89,92	0
2	PDA	K	1000	21/21	0.93	0.22	76,83,87,88	0
2	PDA	L	1000	21/21	0.93	0.24	90,94,117,121	0
2	PDA	I	1000	21/21	0.95	0.17	60,62,85,91	0
2	PDA	E	1000	21/21	0.95	0.17	65,69,81,84	0
2	PDA	C	1000	21/21	0.96	0.16	49,57,74,76	0
2	PDA	F	1000	21/21	0.96	0.16	60,63,89,92	0
2	PDA	D	1000	21/21	0.96	0.20	55,60,71,75	0
2	PDA	G	1000	21/21	0.97	0.19	53,60,77,79	0
2	PDA	H	1000	21/21	0.97	0.14	48,55,72,76	0
2	PDA	A	1000	21/21	0.97	0.18	48,52,66,69	0
2	PDA	B	1000	21/21	0.98	0.18	47,55,65,69	0

The following is a graphical depiction of the model fit to experimental electron density of all instances of the Ligand of Interest. In addition, ligands with molecular weight > 250 and outliers as shown on the geometry validation Tables will also be included. Each fit is shown from different orientation to approximate a three-dimensional view.

Electron density around PDA J 1000:

$2mF_o-DF_c$ (at 0.7 rmsd) in gray
 mF_o-DF_c (at 3 rmsd) in purple (negative)
and green (positive)

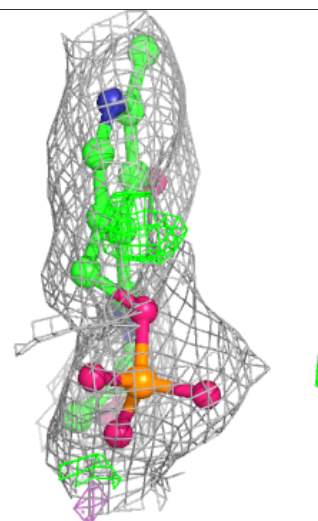
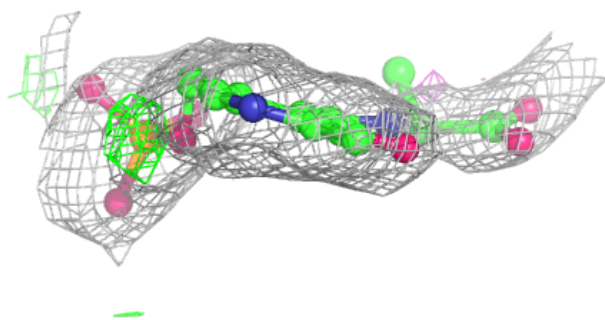
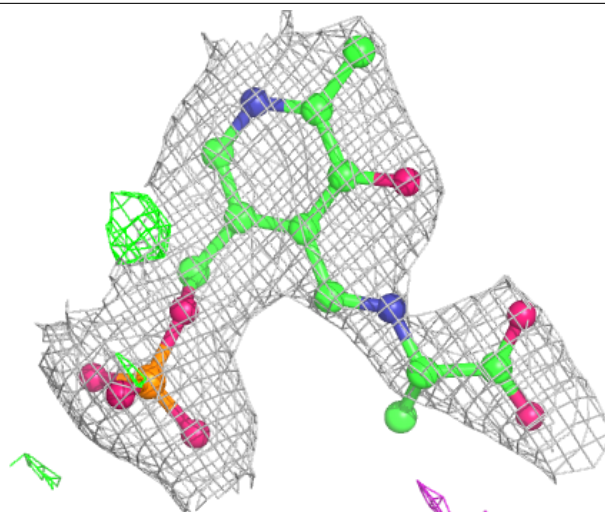

Electron density around PDA K 1000:

$2mF_o-DF_c$ (at 0.7 rmsd) in gray
 mF_o-DF_c (at 3 rmsd) in purple (negative)
and green (positive)

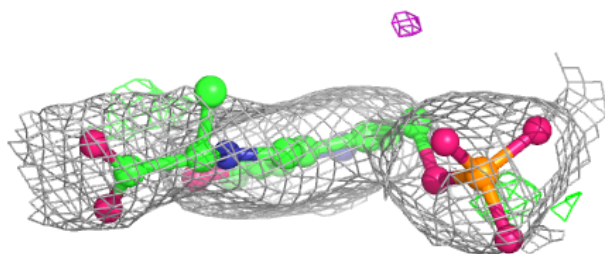
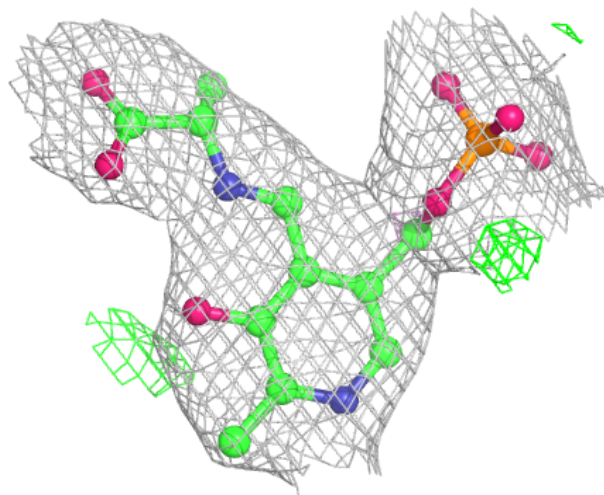

Electron density around PDA L 1000:

$2mF_o-DF_c$ (at 0.7 rmsd) in gray
 mF_o-DF_c (at 3 rmsd) in purple (negative)
and green (positive)

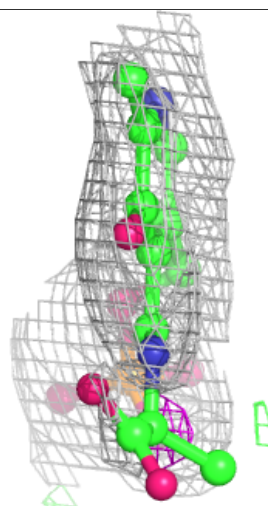
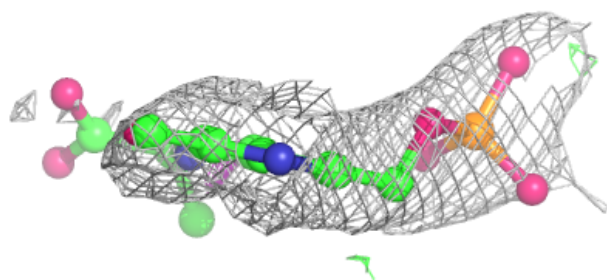
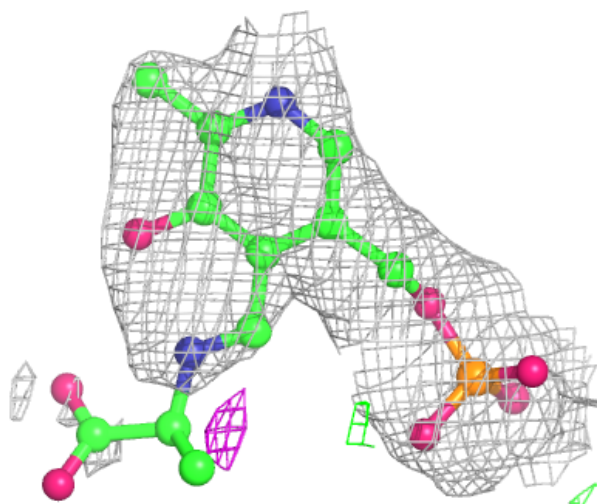

Electron density around PDA I 1000:

$2mF_o-DF_c$ (at 0.7 rmsd) in gray
 mF_o-DF_c (at 3 rmsd) in purple (negative)
and green (positive)

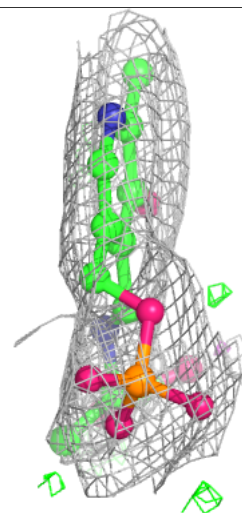
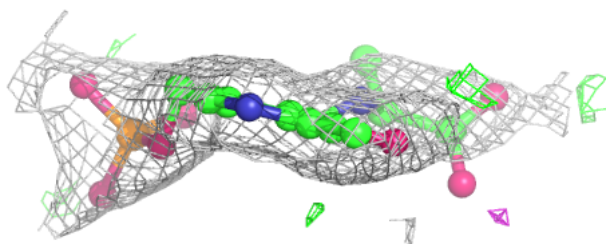
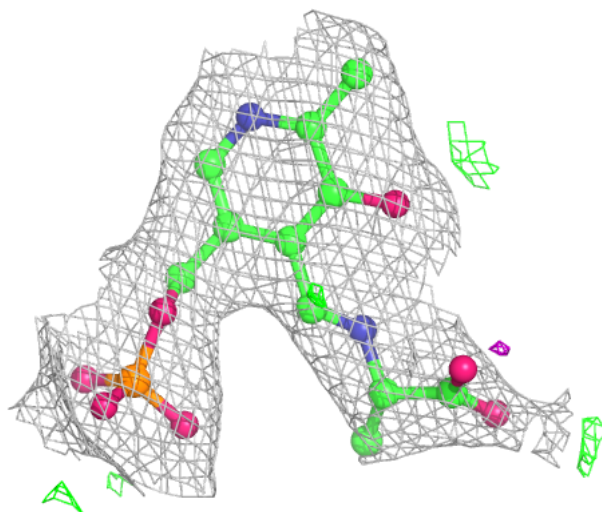

Electron density around PDA E 1000:

$2mF_o-DF_c$ (at 0.7 rmsd) in gray
 mF_o-DF_c (at 3 rmsd) in purple (negative)
and green (positive)

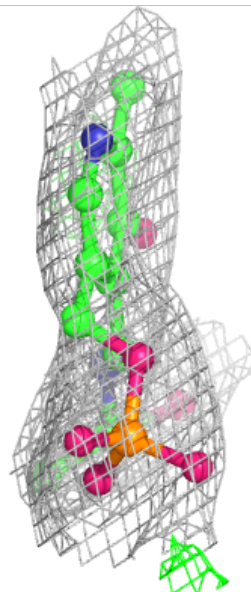
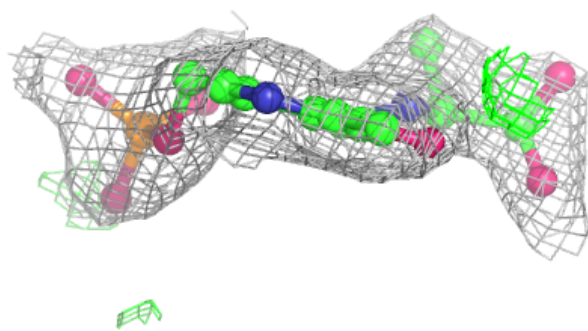
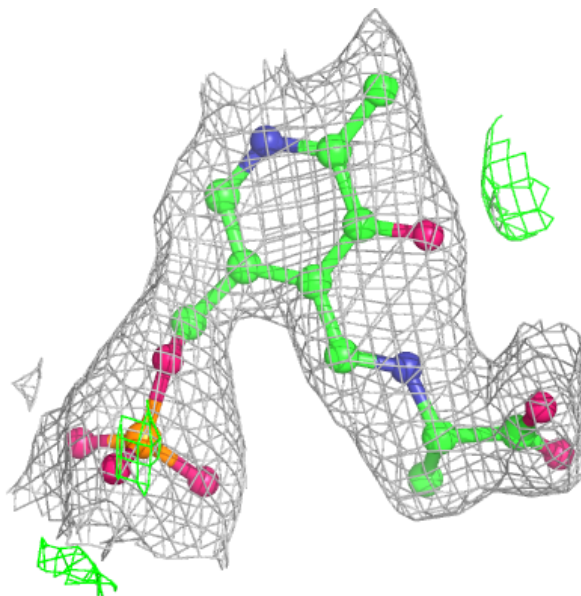

Electron density around PDA C 1000:

$2mF_o-DF_c$ (at 0.7 rmsd) in gray
 mF_o-DF_c (at 3 rmsd) in purple (negative)
and green (positive)

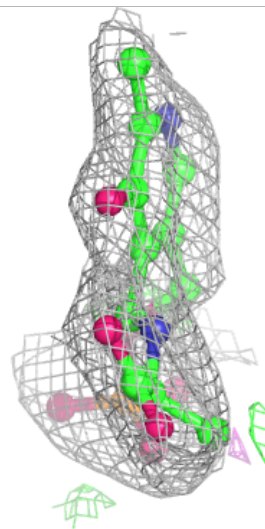
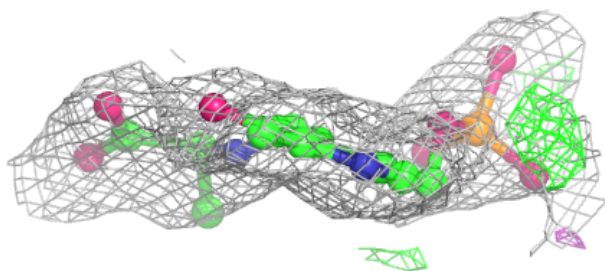
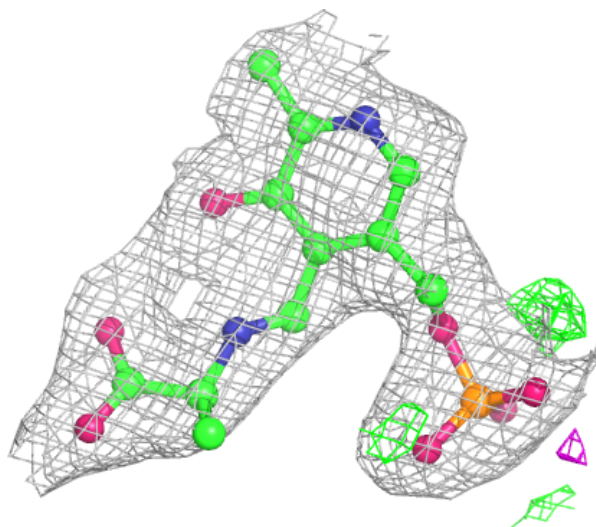

Electron density around PDA F 1000:

$2mF_o-DF_c$ (at 0.7 rmsd) in gray
 mF_o-DF_c (at 3 rmsd) in purple (negative)
and green (positive)

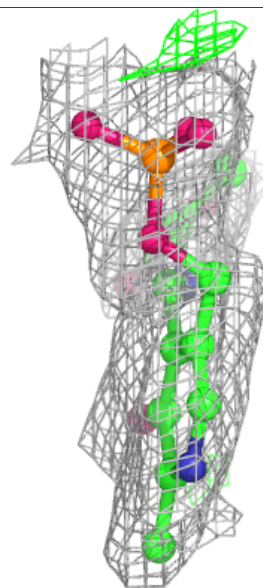
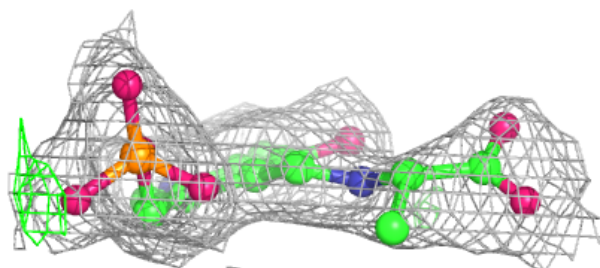
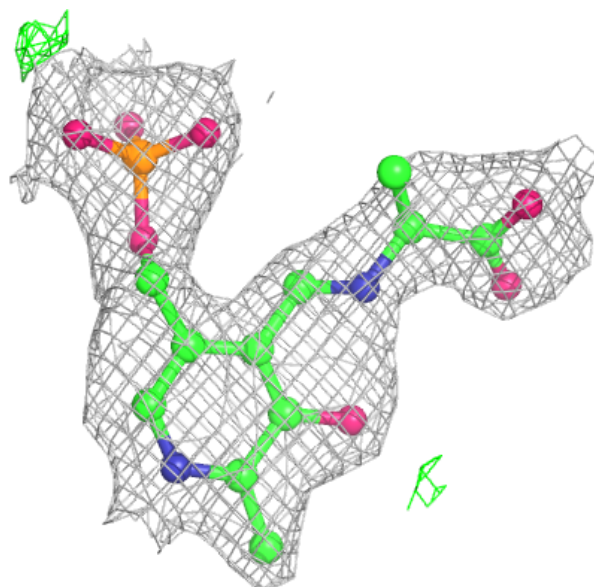

Electron density around PDA D 1000:

$2mF_o-DF_c$ (at 0.7 rmsd) in gray
 mF_o-DF_c (at 3 rmsd) in purple (negative)
and green (positive)

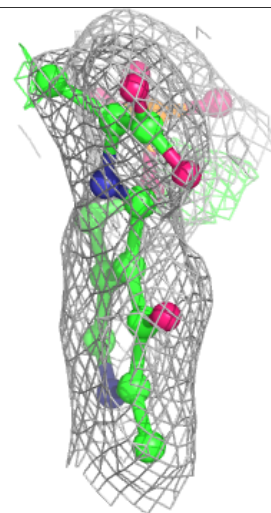
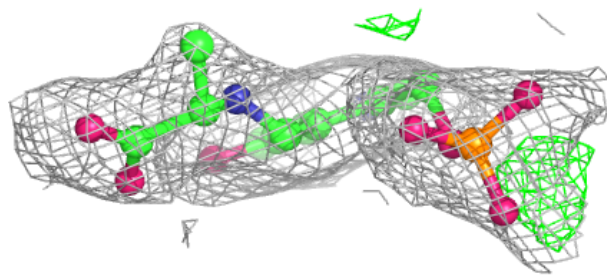
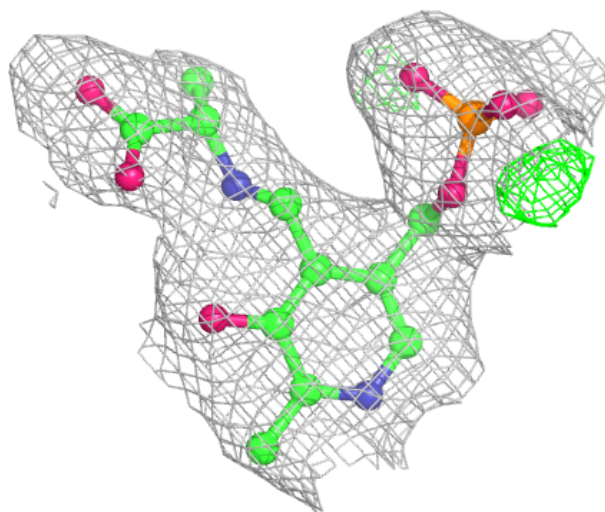

Electron density around PDA G 1000:

$2mF_o-DF_c$ (at 0.7 rmsd) in gray
 mF_o-DF_c (at 3 rmsd) in purple (negative)
and green (positive)

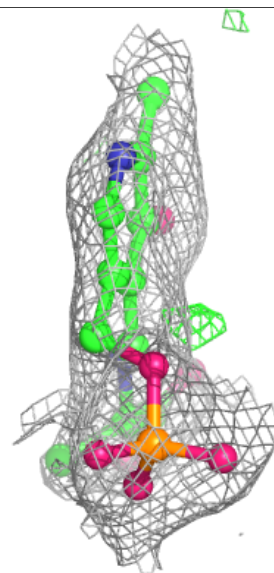
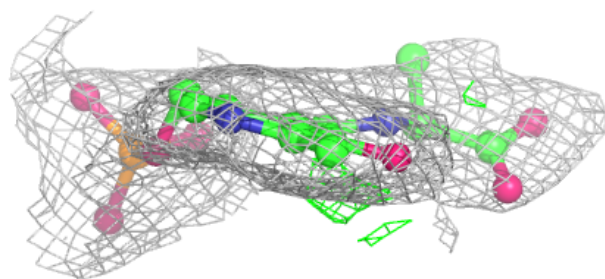
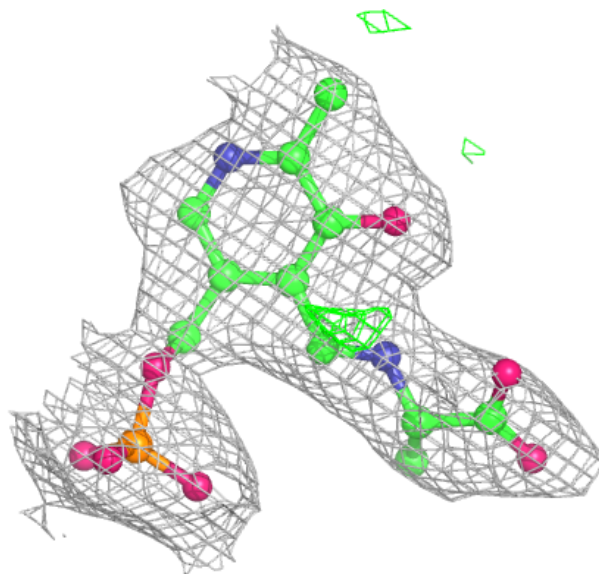

Electron density around PDA H 1000:

$2mF_o-DF_c$ (at 0.7 rmsd) in gray
 mF_o-DF_c (at 3 rmsd) in purple (negative)
and green (positive)

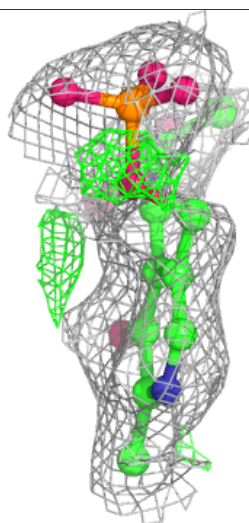
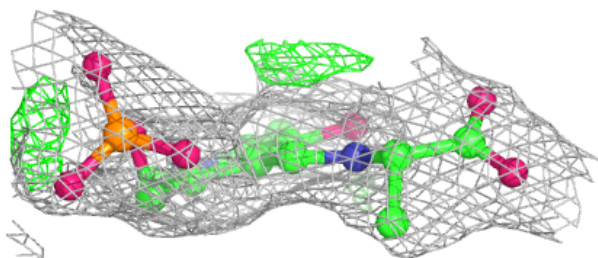
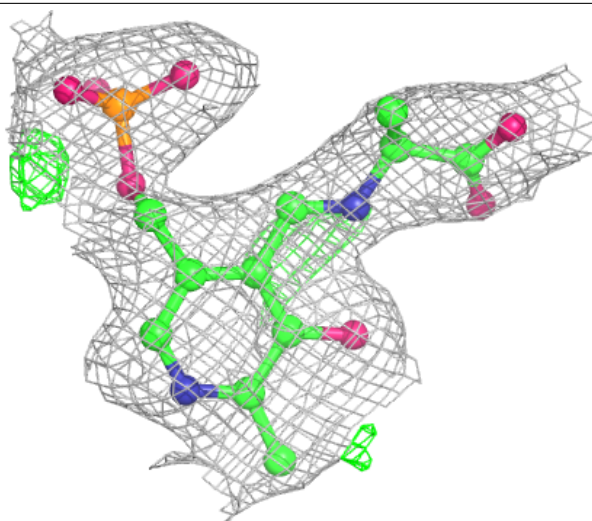

Electron density around PDA A 1000:

$2mF_o-DF_c$ (at 0.7 rmsd) in gray
 mF_o-DF_c (at 3 rmsd) in purple (negative)
and green (positive)

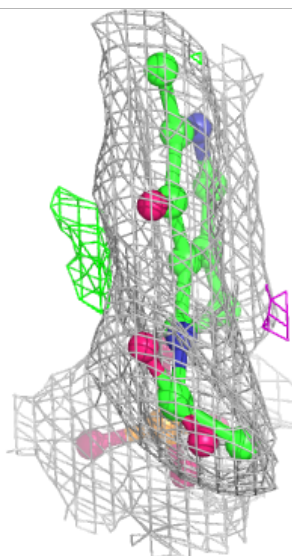
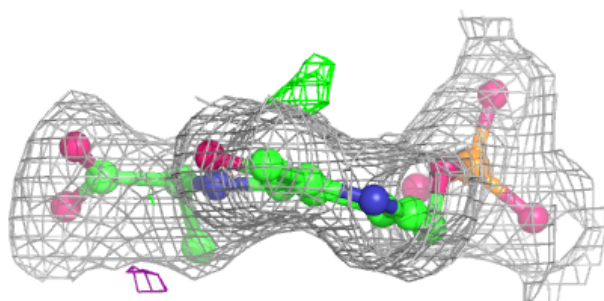
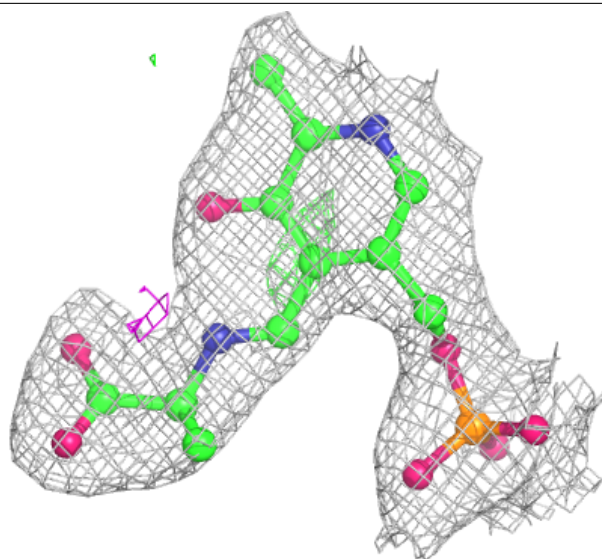

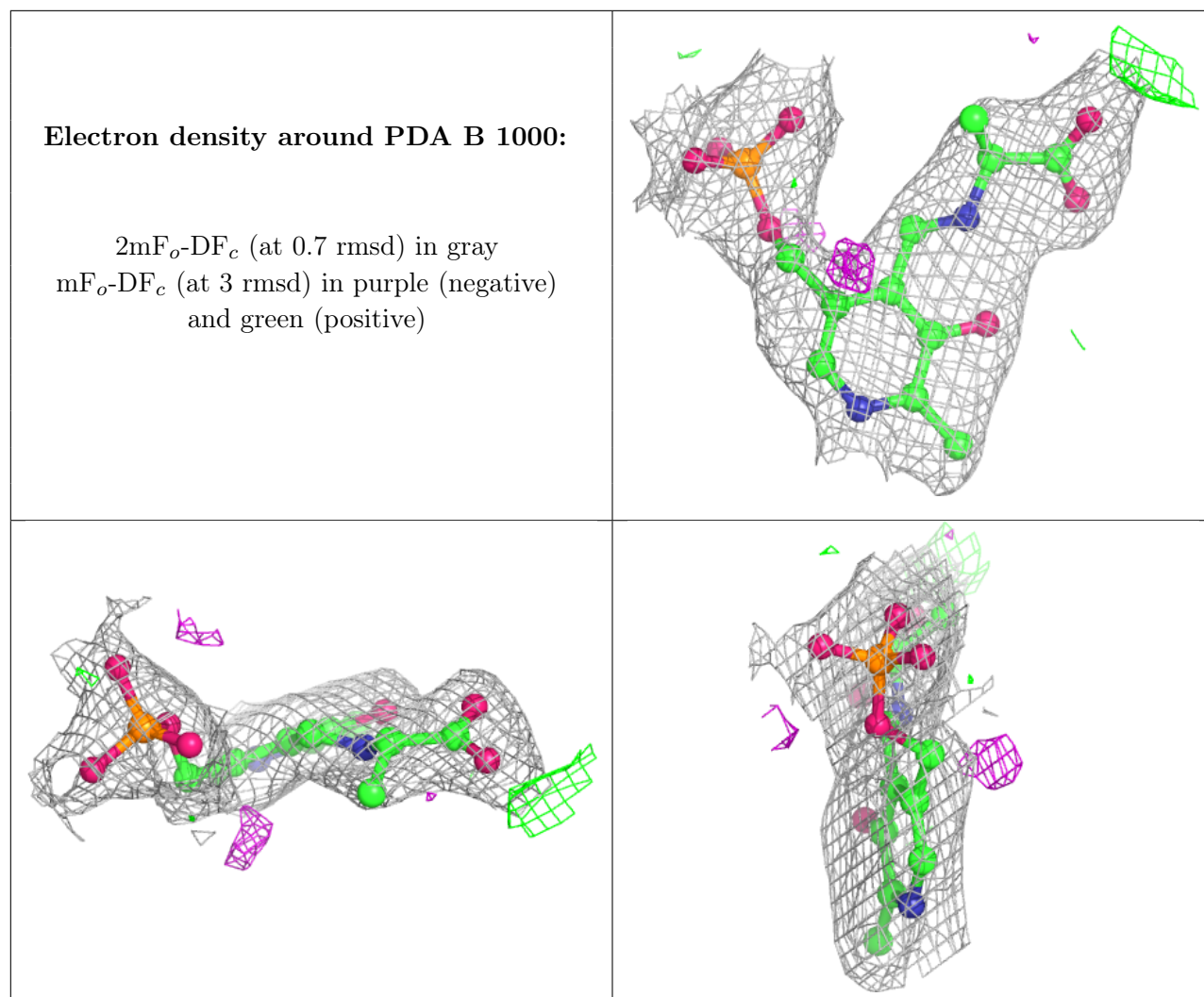

6.5 Other polymers [i](#)

There are no such residues in this entry.