



# wwPDB X-ray Structure Validation Summary Report ⓘ

Jan 30, 2024 – 05:04 PM EST

PDB ID : 1G0R  
Title : THE STRUCTURAL BASIS OF THE CATALYTIC MECHANISM AND REGULATION OF GLUCOSE-1-PHOSPHATE THYMIDYLYLTRANSFERASE (RMLA). THYMIDINE/GLUCOSE-1-PHOSPHATE COMPLEX.  
Authors : Blankenfeldt, W.; Asuncion, M.; Lam, J.S.; Naismith, J.H.  
Deposited on : 2000-10-07  
Resolution : 1.87 Å(reported)

This is a wwPDB X-ray Structure Validation Summary Report for a publicly released PDB entry.

We welcome your comments at [validation@mail.wwpdb.org](mailto:validation@mail.wwpdb.org)

A user guide is available at

<https://www.wwpdb.org/validation/2017/XrayValidationReportHelp>

with specific help available everywhere you see the ⓘ symbol.

The types of validation reports are described at

<http://www.wwpdb.org/validation/2017/FAQs#types>.

---

The following versions of software and data (see [references ⓘ](#)) were used in the production of this report:

MolProbity : 4.02b-467  
Mogul : 1.8.5 (274361), CSD as541be (2020)  
Xtriage (Phenix) : 1.13  
EDS : 2.36  
buster-report : 1.1.7 (2018)  
Percentile statistics : 20191225.v01 (using entries in the PDB archive December 25th 2019)  
Refmac : 5.8.0158  
CCP4 : 7.0.044 (Gargrove)  
Ideal geometry (proteins) : Engh & Huber (2001)  
Ideal geometry (DNA, RNA) : Parkinson et al. (1996)  
Validation Pipeline (wwPDB-VP) : 2.36

# 1 Overall quality at a glance

The following experimental techniques were used to determine the structure:

*X-RAY DIFFRACTION*

The reported resolution of this entry is 1.87 Å.

Percentile scores (ranging between 0-100) for global validation metrics of the entry are shown in the following graphic. The table shows the number of entries on which the scores are based.

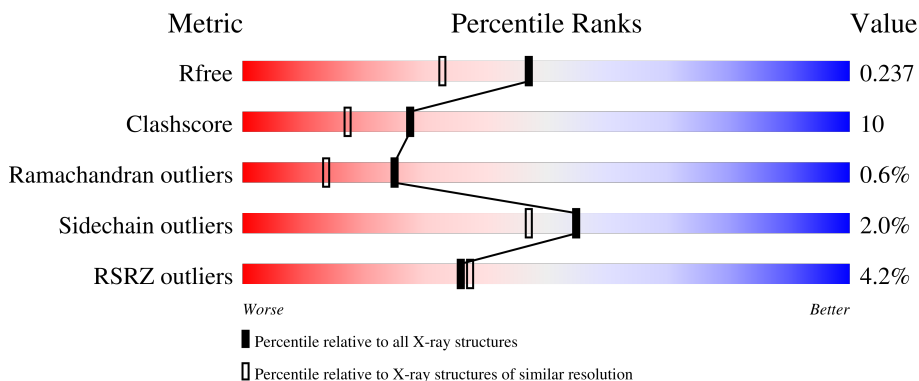

Metric	Whole archive (#Entries)	Similar resolution (#Entries, resolution range(Å))
$R_{free}$	130704	9470 (1.90-1.86)
Clashscore	141614	10282 (1.90-1.86)
Ramachandran outliers	138981	10152 (1.90-1.86)
Sidechain outliers	138945	10152 (1.90-1.86)
RSRZ outliers	127900	9303 (1.90-1.86)

The table below summarises the geometric issues observed across the polymeric chains and their fit to the electron density. The red, orange, yellow and green segments of the lower bar indicate the fraction of residues that contain outliers for  $\geq 3$ , 2, 1 and 0 types of geometric quality criteria respectively. A grey segment represents the fraction of residues that are not modelled. The numeric value for each fraction is indicated below the corresponding segment, with a dot representing fractions  $\leq 5\%$ . The upper red bar (where present) indicates the fraction of residues that have poor fit to the electron density. The numeric value is given above the bar.

Mol	Chain	Length	Quality of chain
1	A	293	 4% 80% 20%
1	B	293	 2% 77% 20% .
1	C	293	 3% 75% 22% .
1	D	293	 7% 74% 21% . .

*Continued on next page...*

*Continued from previous page...*

Mol	Chain	Length	Quality of chain
1	E	293	
1	F	293	
1	G	293	
1	H	293	

The following table lists non-polymeric compounds, carbohydrate monomers and non-standard residues in protein, DNA, RNA chains that are outliers for geometric or electron-density-fit criteria:

Mol	Type	Chain	Res	Chirality	Geometry	Clashes	Electron density
3	SO4	A	2507	-	-	X	-
4	THM	F	2535	-	X	-	-

## 2 Entry composition

There are 5 unique types of molecules in this entry. The entry contains 21361 atoms, of which 0 are hydrogens and 0 are deuteriums.

In the tables below, the ZeroOcc column contains the number of atoms modelled with zero occupancy, the AltConf column contains the number of residues with at least one atom in alternate conformation and the Trace column contains the number of residues modelled with at most 2 atoms.

- Molecule 1 is a protein called GLUCOSE-1-PHOSPHATE THYMIDYLYLTRANSFERASE.

Mol	Chain	Residues	Atoms					ZeroOcc	AltConf	Trace
			Total	C	N	O	S			
1	A	292	Total 2338	C 1493	N 396	O 444	S 5	0	6	0
1	B	292	Total 2350	C 1501	N 396	O 447	S 6	0	8	0
1	C	292	Total 2332	C 1491	N 395	O 441	S 5	0	5	0
1	D	292	Total 2325	C 1486	N 391	O 442	S 6	0	5	0
1	E	292	Total 2312	C 1477	N 389	O 440	S 6	0	4	0
1	F	293	Total 2340	C 1496	N 395	O 443	S 6	0	5	0
1	G	292	Total 2326	C 1487	N 390	O 443	S 6	0	5	0
1	H	292	Total 2303	C 1474	N 387	O 437	S 5	0	2	0

- Molecule 2 is 1-O-phosphono-alpha-D-glucopyranose (three-letter code: G1P) (formula: C<sub>6</sub>H<sub>13</sub>O<sub>9</sub>P).

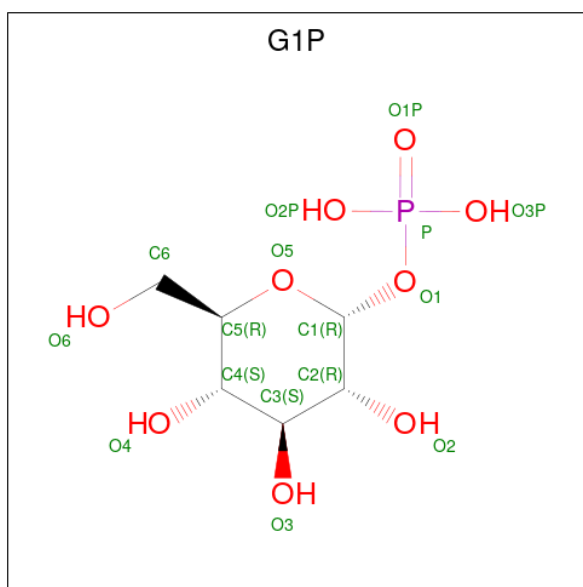

Mol	Chain	Residues	Atoms				ZeroOcc	AltConf
			Total	C	O	P		
2	A	1	Total	C	O	P	0	0
			16	6	9	1		
2	B	1	Total	C	O	P	0	0
			16	6	9	1		
2	C	1	Total	C	O	P	0	0
			16	6	9	1		
2	D	1	Total	C	O	P	0	0
			16	6	9	1		
2	E	1	Total	C	O	P	0	0
			16	6	9	1		
2	G	1	Total	C	O	P	0	0
			16	6	9	1		
2	H	1	Total	C	O	P	0	0
			16	6	9	1		

- Molecule 3 is SULFATE ION (three-letter code: SO4) (formula: O<sub>4</sub>S).



Mol	Chain	Residues	Atoms			ZeroOcc	AltConf
3	A	1	Total	O	S	0	0
			5	4	1		
3	A	1	Total	O	S	0	0
			5	4	1		
3	B	1	Total	O	S	0	0
			5	4	1		
3	B	1	Total	O	S	0	0
			5	4	1		
3	B	1	Total	O	S	0	0
			5	4	1		
3	C	1	Total	O	S	0	0
			5	4	1		
3	C	1	Total	O	S	0	0
			5	4	1		
3	C	1	Total	O	S	0	0
			5	4	1		
3	D	1	Total	O	S	0	0
			5	4	1		
3	D	1	Total	O	S	0	0
			5	4	1		
3	D	1	Total	O	S	0	0
			5	4	1		
3	D	1	Total	O	S	0	0
			5	4	1		
3	E	1	Total	O	S	0	0
			5	4	1		
3	E	1	Total	O	S	0	0
			5	4	1		

*Continued on next page...*

Continued from previous page...

Mol	Chain	Residues	Atoms			ZeroOcc	AltConf
3	F	1	Total	O	S	0	0
			5	4	1		
3	F	1	Total	O	S	0	0
			5	4	1		
3	F	1	Total	O	S	0	0
			5	4	1		
3	F	1	Total	O	S	0	0
			5	4	1		
3	G	1	Total	O	S	0	0
			5	4	1		
3	G	1	Total	O	S	0	0
			5	4	1		
3	H	1	Total	O	S	0	0
			5	4	1		
3	H	1	Total	O	S	0	0
			5	4	1		
3	H	1	Total	O	S	0	0
			5	4	1		

- Molecule 4 is THYMIDINE (three-letter code: THM) (formula: C<sub>10</sub>H<sub>14</sub>N<sub>2</sub>O<sub>5</sub>).

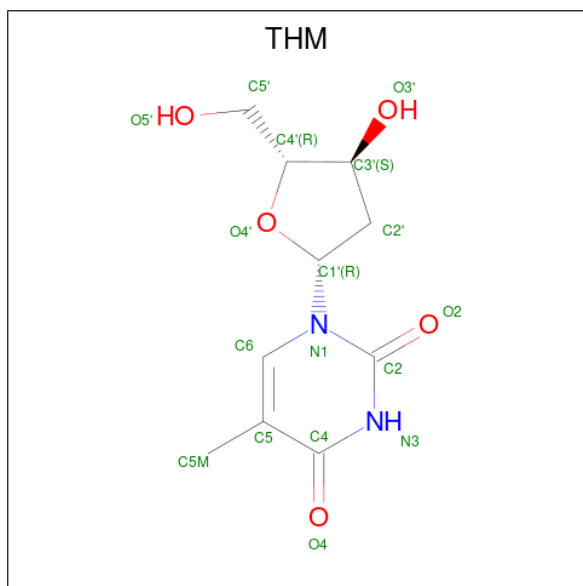

Mol	Chain	Residues	Atoms				ZeroOcc	AltConf
4	A	1	Total	C	N	O	0	0
			17	10	2	5		
4	A	1	Total	C	N	O	0	0
			17	10	2	5		

Continued on next page...

*Continued from previous page...*

Mol	Chain	Residues	Atoms				ZeroOcc	AltConf
4	B	1	Total	C	N	O	0	0
			17	10	2	5		
4	B	1	Total	C	N	O	0	0
			17	10	2	5		
4	C	1	Total	C	N	O	0	0
			17	10	2	5		
4	C	1	Total	C	N	O	0	0
			17	10	2	5		
4	D	1	Total	C	N	O	0	0
			17	10	2	5		
4	D	1	Total	C	N	O	0	0
			17	10	2	5		
4	E	1	Total	C	N	O	0	0
			17	10	2	5		
4	E	1	Total	C	N	O	0	0
			17	10	2	5		
4	F	1	Total	C	N	O	0	0
			17	10	2	5		
4	F	1	Total	C	N	O	0	0
			17	10	2	5		
4	G	1	Total	C	N	O	0	0
			17	10	2	5		
4	G	1	Total	C	N	O	0	0
			17	10	2	5		
4	H	1	Total	C	N	O	0	0
			17	10	2	5		
4	H	1	Total	C	N	O	0	0
			17	10	2	5		

- Molecule 5 is water.

Mol	Chain	Residues	Atoms		ZeroOcc	AltConf
5	A	286	Total	O	0	0
			286	286		
5	B	307	Total	O	0	0
			307	307		
5	C	272	Total	O	0	0
			272	272		
5	D	266	Total	O	0	0
			266	266		
5	E	202	Total	O	0	0
			202	202		

*Continued on next page...*



*Continued from previous page...*

<b>Mol</b>	<b>Chain</b>	<b>Residues</b>	<b>Atoms</b>		<b>ZeroOcc</b>	<b>AltConf</b>
5	F	287	Total 287	O 287	0	0
5	G	327	Total 327	O 327	0	0
5	H	289	Total 289	O 289	0	0

### 3 Residue-property plots [i](#)

These plots are drawn for all protein, RNA, DNA and oligosaccharide chains in the entry. The first graphic for a chain summarises the proportions of the various outlier classes displayed in the second graphic. The second graphic shows the sequence view annotated by issues in geometry and electron density. Residues are color-coded according to the number of geometric quality criteria for which they contain at least one outlier: green = 0, yellow = 1, orange = 2 and red = 3 or more. A red dot above a residue indicates a poor fit to the electron density ( $RSRZ > 2$ ). Stretches of 2 or more consecutive residues without any outlier are shown as a green connector. Residues present in the sample, but not in the model, are shown in grey.

- Molecule 1: GLUCOSE-1-PHOSPHATE THYMIDYLYLTRANSFERASE

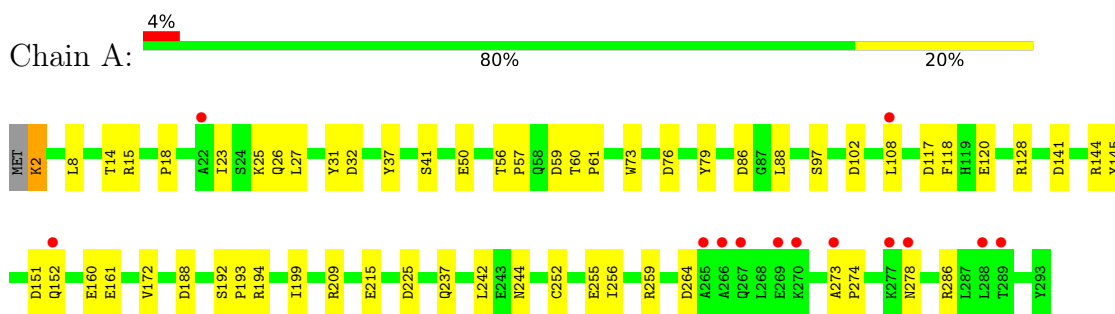

- Molecule 1: GLUCOSE-1-PHOSPHATE THYMIDYLYLTRANSFERASE

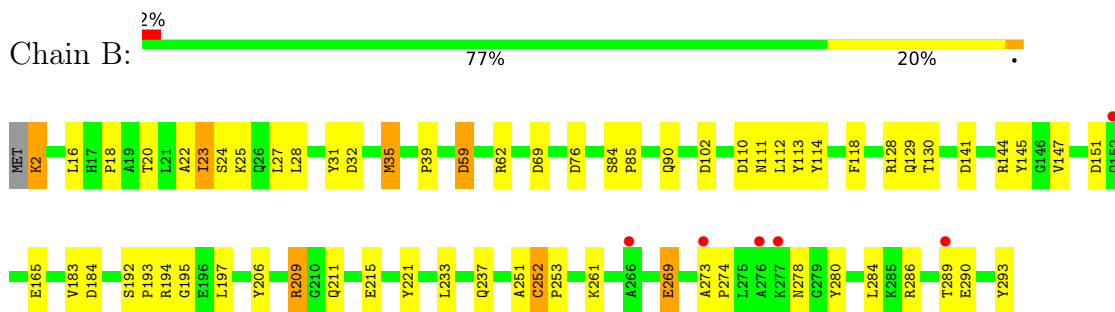

- Molecule 1: GLUCOSE-1-PHOSPHATE THYMIDYLYLTRANSFERASE

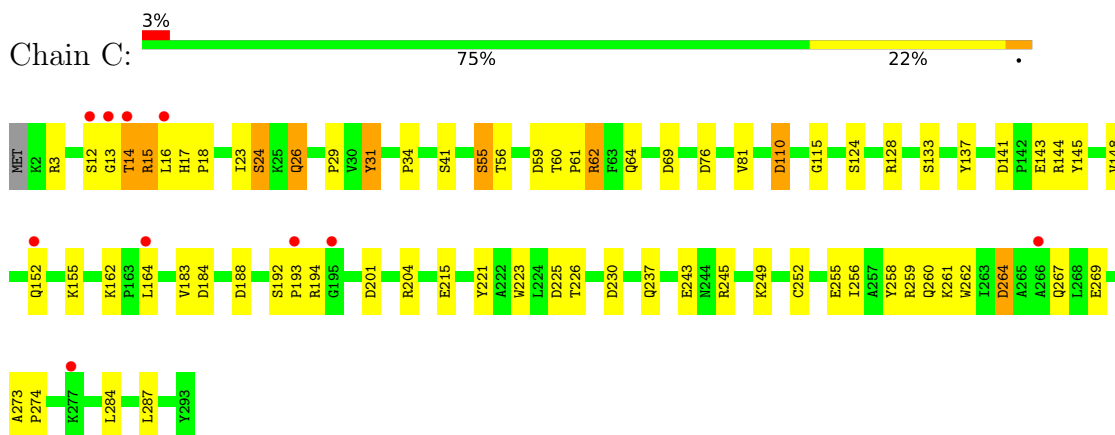

- Molecule 1: GLUCOSE-1-PHOSPHATE THYMIDYLYLTRANSFERASE

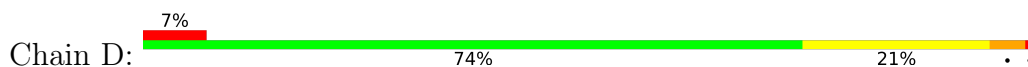

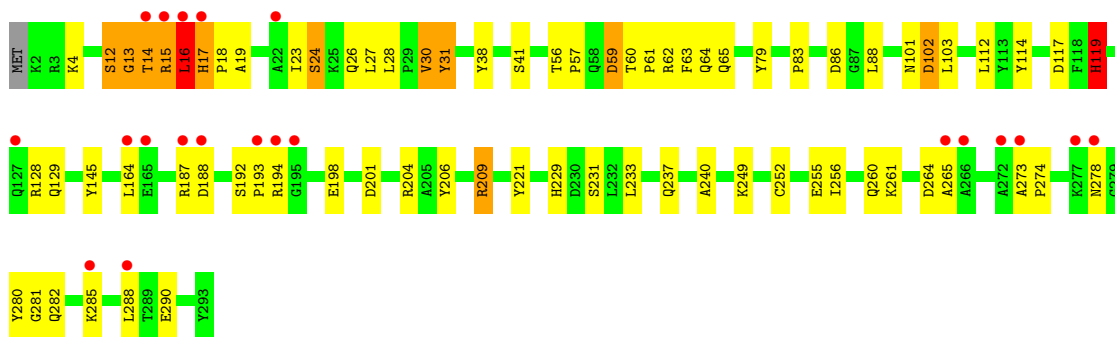

● Molecule 1: GLUCOSE-1-PHOSPHATE THYMIDYLYLTRANSFERASE

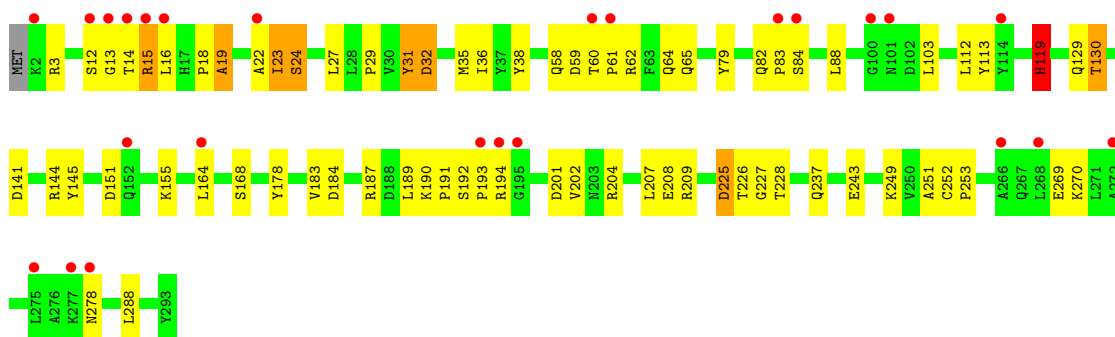
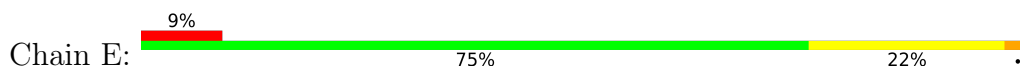

● Molecule 1: GLUCOSE-1-PHOSPHATE THYMIDYLYLTRANSFERASE

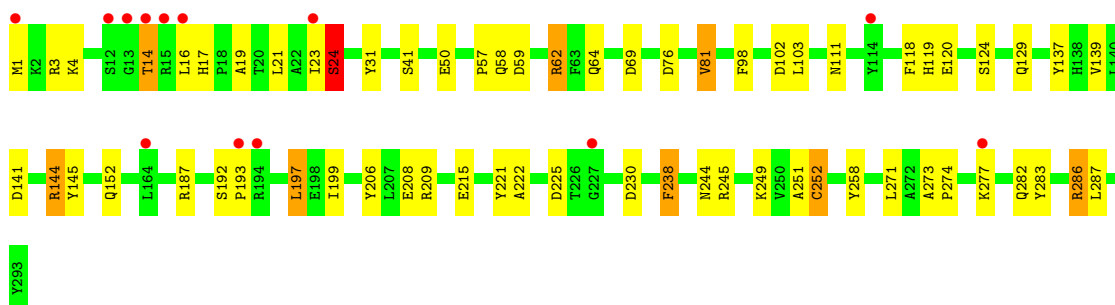
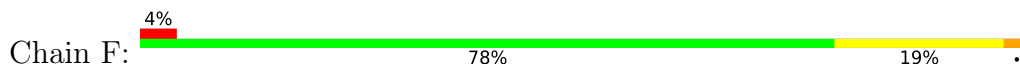

● Molecule 1: GLUCOSE-1-PHOSPHATE THYMIDYLYLTRANSFERASE

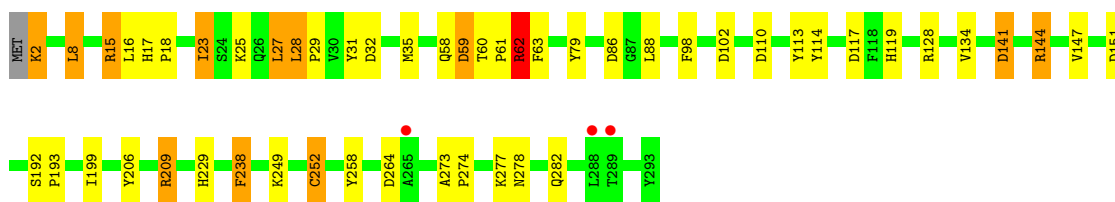
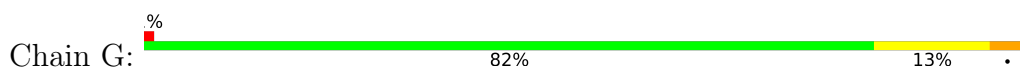

● Molecule 1: GLUCOSE-1-PHOSPHATE THYMIDYLYLTRANSFERASE

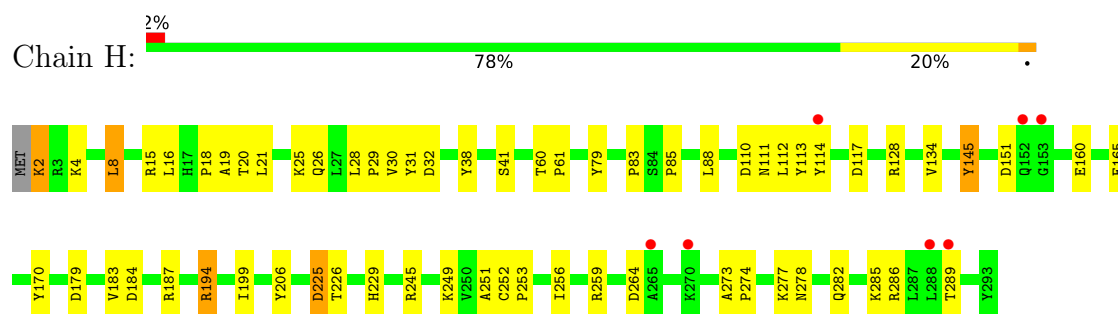

## 4 Data and refinement statistics

Property	Value	Source
Space group	P 1	Depositor
Cell constants a, b, c, $\alpha$ , $\beta$ , $\gamma$	71.27Å 73.08Å 133.65Å 89.98° 81.42° 81.56°	Depositor
Resolution (Å)	73.00 – 1.87 36.27 – 1.87	Depositor EDS
% Data completeness (in resolution range)	84.0 (73.00-1.87) 84.7 (36.27-1.87)	Depositor EDS
$R_{merge}$	0.07	Depositor
$R_{sym}$	(Not available)	Depositor
$\langle I/\sigma(I) \rangle$ <sup>1</sup>	1.47 (at 1.88Å)	Xtrriage
Refinement program	REFMAC	Depositor
R, $R_{free}$	0.147 , 0.221 0.167 , 0.237	Depositor DCC
$R_{free}$ test set	9145 reflections (4.99%)	wwPDB-VP
Wilson B-factor (Å <sup>2</sup> )	21.7	Xtrriage
Anisotropy	0.162	Xtrriage
Bulk solvent $k_{sol}$ (e/Å <sup>3</sup> ), $B_{sol}$ (Å <sup>2</sup> )	0.35 , 55.4	EDS
L-test for twinning <sup>2</sup>	$\langle  L  \rangle = 0.49$ , $\langle L^2 \rangle = 0.32$	Xtrriage
Estimated twinning fraction	No twinning to report.	Xtrriage
$F_o, F_c$ correlation	0.96	EDS
Total number of atoms	21361	wwPDB-VP
Average B, all atoms (Å <sup>2</sup> )	21.0	wwPDB-VP

Xtrriage's analysis on translational NCS is as follows: *The largest off-origin peak in the Patterson function is 4.35% of the height of the origin peak. No significant pseudotranslation is detected.*

<sup>1</sup>Intensities estimated from amplitudes.

<sup>2</sup>Theoretical values of  $\langle |L| \rangle$ ,  $\langle L^2 \rangle$  for acentric reflections are 0.5, 0.333 respectively for untwinned datasets, and 0.375, 0.2 for perfectly twinned datasets.

## 5 Model quality i

### 5.1 Standard geometry i

Bond lengths and bond angles in the following residue types are not validated in this section: SO4, THM, G1P

The Z score for a bond length (or angle) is the number of standard deviations the observed value is removed from the expected value. A bond length (or angle) with  $|Z| > 5$  is considered an outlier worth inspection. RMSZ is the root-mean-square of all Z scores of the bond lengths (or angles).

Mol	Chain	Bond lengths		Bond angles	
		RMSZ	# Z  >5	RMSZ	# Z  >5
1	A	1.44	10/2389 (0.4%)	1.17	16/3241 (0.5%)
1	B	1.46	13/2401 (0.5%)	1.19	16/3256 (0.5%)
1	C	1.43	7/2383 (0.3%)	1.20	14/3232 (0.4%)
1	D	1.40	10/2375 (0.4%)	1.19	12/3222 (0.4%)
1	E	1.31	7/2362 (0.3%)	1.14	10/3205 (0.3%)
1	F	1.49	17/2391 (0.7%)	1.25	14/3242 (0.4%)
1	G	1.53	20/2377 (0.8%)	1.32	22/3225 (0.7%)
1	H	1.42	10/2354 (0.4%)	1.15	11/3195 (0.3%)
All	All	1.44	94/19032 (0.5%)	1.20	115/25818 (0.4%)

Chiral center outliers are detected by calculating the chiral volume of a chiral center and verifying if the center is modelled as a planar moiety or with the opposite hand. A planarity outlier is detected by checking planarity of atoms in a peptide group, atoms in a mainchain group or atoms of a sidechain that are expected to be planar.

Mol	Chain	#Chirality outliers	#Planarity outliers
1	D	0	2
1	E	0	1
All	All	0	3

The worst 5 of 94 bond length outliers are listed below:

Mol	Chain	Res	Type	Atoms	Z	Observed(Å)	Ideal(Å)
1	D	114	TYR	CG-CD1	-10.11	1.26	1.39
1	F	81	VAL	CB-CG1	-9.19	1.33	1.52
1	C	137	TYR	CD1-CE1	-8.48	1.26	1.39
1	C	55	SER	CB-OG	8.20	1.52	1.42
1	C	223	TRP	CE3-CZ3	-7.56	1.25	1.38

The worst 5 of 115 bond angle outliers are listed below:

Mol	Chain	Res	Type	Atoms	Z	Observed(°)	Ideal(°)
1	G	209	ARG	NE-CZ-NH2	-13.04	113.78	120.30
1	D	188	ASP	CB-CG-OD2	10.32	127.58	118.30
1	G	141	ASP	CB-CG-OD2	10.29	127.56	118.30
1	G	35[A]	MET	CB-CG-SD	-10.18	81.86	112.40
1	G	35[B]	MET	CB-CG-SD	-10.18	81.86	112.40

There are no chirality outliers.

All (3) planarity outliers are listed below:

Mol	Chain	Res	Type	Group
1	D	119	HIS	Sidechain
1	D	16	LEU	Peptide
1	E	119	HIS	Sidechain

## 5.2 Too-close contacts [i](#)

In the following table, the Non-H and H(model) columns list the number of non-hydrogen atoms and hydrogen atoms in the chain respectively. The H(added) column lists the number of hydrogen atoms added and optimized by MolProbity. The Clashes column lists the number of clashes within the asymmetric unit, whereas Symm-Clashes lists symmetry-related clashes.

Mol	Chain	Non-H	H(model)	H(added)	Clashes	Symm-Clashes
1	A	2338	0	2315	36	0
1	B	2350	0	2327	47	0
1	C	2332	0	2315	63	0
1	D	2325	0	2307	62	0
1	E	2312	0	2295	68	0
1	F	2340	0	2326	50	0
1	G	2326	0	2303	36	0
1	H	2303	0	2285	46	0
2	A	16	0	11	2	0
2	B	16	0	11	2	0
2	C	16	0	11	2	0
2	D	16	0	11	2	0
2	E	16	0	11	2	0
2	G	16	0	11	1	0
2	H	16	0	11	1	0
3	A	10	0	0	3	0
3	B	15	0	0	0	0
3	C	15	0	0	0	0
3	D	20	0	0	0	0
3	E	10	0	0	1	0

*Continued on next page...*

*Continued from previous page...*

Mol	Chain	Non-H	H(model)	H(added)	Clashes	Symm-Clashes
3	F	20	0	0	1	0
3	G	10	0	0	0	0
3	H	15	0	0	2	0
4	A	34	0	27	1	0
4	B	34	0	27	0	0
4	C	34	0	27	0	0
4	D	34	0	27	0	0
4	E	34	0	27	0	0
4	F	34	0	26	2	0
4	G	34	0	27	1	0
4	H	34	0	27	2	0
5	A	286	0	0	4	0
5	B	307	0	0	13	0
5	C	272	0	0	16	0
5	D	266	0	0	15	0
5	E	202	0	0	15	0
5	F	287	0	0	19	0
5	G	327	0	0	10	0
5	H	289	0	0	15	0
All	All	21361	0	18765	379	0

The all-atom clashscore is defined as the number of clashes found per 1000 atoms (including hydrogen atoms). The all-atom clashscore for this structure is 10.

The worst 5 of 379 close contacts within the same asymmetric unit are listed below, sorted by their clash magnitude.

Atom-1	Atom-2	Interatomic distance (Å)	Clash overlap (Å)
1:B:141:ASP:HB2	5:B:2787:HOH:O	1.33	1.25
1:G:282:GLN:HG2	5:G:2851:HOH:O	1.38	1.23
1:G:141:ASP:HB2	5:G:2617:HOH:O	1.39	1.18
1:H:60:THR:HG23	5:H:2715:HOH:O	1.51	1.10
5:B:2699:HOH:O	1:E:155:LYS:HE3	1.63	0.99

There are no symmetry-related clashes.



## 5.3 Torsion angles [i](#)

### 5.3.1 Protein backbone [i](#)

In the following table, the Percentiles column shows the percent Ramachandran outliers of the chain as a percentile score with respect to all X-ray entries followed by that with respect to entries of similar resolution.

The Analysed column shows the number of residues for which the backbone conformation was analysed, and the total number of residues.

Mol	Chain	Analysed	Favoured	Allowed	Outliers	Percentiles	
1	A	296/293 (101%)	290 (98%)	6 (2%)	0	100	100
1	B	298/293 (102%)	293 (98%)	3 (1%)	2 (1%)	22	11
1	C	295/293 (101%)	287 (97%)	6 (2%)	2 (1%)	22	11
1	D	295/293 (101%)	284 (96%)	7 (2%)	4 (1%)	11	3
1	E	294/293 (100%)	279 (95%)	12 (4%)	3 (1%)	15	6
1	F	296/293 (101%)	289 (98%)	5 (2%)	2 (1%)	22	11
1	G	295/293 (101%)	291 (99%)	3 (1%)	1 (0%)	41	30
1	H	292/293 (100%)	285 (98%)	7 (2%)	0	100	100
All	All	2361/2344 (101%)	2298 (97%)	49 (2%)	14 (1%)	25	14

5 of 14 Ramachandran outliers are listed below:

Mol	Chain	Res	Type
1	D	14	THR
1	E	14	THR
1	B	23	ILE
1	F	31	TYR
1	B	31	TYR

### 5.3.2 Protein sidechains [i](#)

In the following table, the Percentiles column shows the percent sidechain outliers of the chain as a percentile score with respect to all X-ray entries followed by that with respect to entries of similar resolution.

The Analysed column shows the number of residues for which the sidechain conformation was analysed, and the total number of residues.

Mol	Chain	Analysed	Rotameric	Outliers	Percentiles	
1	A	245/240 (102%)	244 (100%)	1 (0%)	91	90

*Continued on next page...*

*Continued from previous page...*

Mol	Chain	Analysed	Rotameric	Outliers	Percentiles	
1	B	247/240 (103%)	241 (98%)	6 (2%)	49	39
1	C	244/240 (102%)	240 (98%)	4 (2%)	62	56
1	D	244/240 (102%)	239 (98%)	5 (2%)	55	47
1	E	243/240 (101%)	233 (96%)	10 (4%)	30	19
1	F	245/240 (102%)	240 (98%)	5 (2%)	55	47
1	G	244/240 (102%)	241 (99%)	3 (1%)	71	67
1	H	241/240 (100%)	236 (98%)	5 (2%)	53	45
All	All	1953/1920 (102%)	1914 (98%)	39 (2%)	55	47

5 of 39 residues with a non-rotameric sidechain are listed below:

Mol	Chain	Res	Type
1	F	197	LEU
1	H	111	ASN
1	F	199	ILE
1	G	62	ARG
1	H	225	ASP

Sometimes sidechains can be flipped to improve hydrogen bonding and reduce clashes. 5 of 14 such sidechains are listed below:

Mol	Chain	Res	Type
1	E	26	GLN
1	F	65	GLN
1	H	278	ASN
1	G	229	HIS
1	H	26	GLN

### 5.3.3 RNA ⓘ

There are no RNA molecules in this entry.

## 5.4 Non-standard residues in protein, DNA, RNA chains ⓘ

There are no non-standard protein/DNA/RNA residues in this entry.

## 5.5 Carbohydrates [i](#)

There are no monosaccharides in this entry.

## 5.6 Ligand geometry [i](#)

46 ligands are modelled in this entry.

In the following table, the Counts columns list the number of bonds (or angles) for which Mogul statistics could be retrieved, the number of bonds (or angles) that are observed in the model and the number of bonds (or angles) that are defined in the Chemical Component Dictionary. The Link column lists molecule types, if any, to which the group is linked. The Z score for a bond length (or angle) is the number of standard deviations the observed value is removed from the expected value. A bond length (or angle) with  $|Z| > 2$  is considered an outlier worth inspection. RMSZ is the root-mean-square of all Z scores of the bond lengths (or angles).

Mol	Type	Chain	Res	Link	Bond lengths			Bond angles		
					Counts	RMSZ	# $ Z  > 2$	Counts	RMSZ	# $ Z  > 2$
4	THM	F	2535	-	18,18,18	2.60	8 (44%)	26,26,26	3.61	19 (73%)
2	G1P	H	2506	-	15,16,16	1.86	5 (33%)	23,24,24	3.88	5 (21%)
3	SO4	C	2509	-	4,4,4	0.65	0	6,6,6	1.03	0
4	THM	C	2540	-	18,18,18	2.42	8 (44%)	26,26,26	2.39	11 (42%)
3	SO4	B	2528	-	4,4,4	0.78	0	6,6,6	0.82	0
3	SO4	H	2529	-	4,4,4	0.34	0	6,6,6	1.06	0
4	THM	B	2531	-	18,18,18	2.55	7 (38%)	26,26,26	2.90	14 (53%)
3	SO4	G	2525	-	4,4,4	0.52	0	6,6,6	1.13	0
3	SO4	A	2508	-	4,4,4	0.84	0	6,6,6	1.04	0
4	THM	A	2530	-	18,18,18	2.57	8 (44%)	26,26,26	3.46	15 (57%)
3	SO4	F	2521	-	4,4,4	0.73	0	6,6,6	0.84	0
3	SO4	E	2527	-	4,4,4	1.02	0	6,6,6	0.70	0
4	THM	G	2544	-	18,18,18	2.33	5 (27%)	26,26,26	2.41	11 (42%)
3	SO4	B	2511	-	4,4,4	0.78	0	6,6,6	1.09	0
3	SO4	F	2522	-	4,4,4	0.34	0	6,6,6	0.57	0
4	THM	B	2539	-	18,18,18	2.59	5 (27%)	26,26,26	2.76	10 (38%)
4	THM	C	2532	-	18,18,18	2.47	7 (38%)	26,26,26	3.10	16 (61%)
2	G1P	G	2505	-	15,16,16	1.64	3 (20%)	23,24,24	3.38	7 (30%)
3	SO4	C	2515	-	4,4,4	0.34	0	6,6,6	0.66	0
4	THM	H	2537	-	18,18,18	3.11	8 (44%)	26,26,26	2.73	10 (38%)
4	THM	F	2543	-	18,18,18	2.22	5 (27%)	26,26,26	2.80	8 (30%)
3	SO4	D	2516	-	4,4,4	0.83	0	6,6,6	0.14	0
2	G1P	E	2504	-	15,16,16	1.96	3 (20%)	23,24,24	5.21	9 (39%)
3	SO4	C	2513	-	4,4,4	1.07	0	6,6,6	0.61	0

Mol	Type	Chain	Res	Link	Bond lengths			Bond angles		
					Counts	RMSZ	# Z  > 2	Counts	RMSZ	# Z  > 2
3	SO4	D	2517	-	4,4,4	0.20	0	6,6,6	0.71	0
4	THM	G	2536	-	18,18,18	2.43	9 (50%)	26,26,26	3.09	14 (53%)
3	SO4	A	2507	-	4,4,4	0.91	0	6,6,6	1.01	1 (16%)
4	THM	E	2534	-	18,18,18	2.44	6 (33%)	26,26,26	3.64	14 (53%)
2	G1P	B	2501	-	15,16,16	2.20	4 (26%)	23,24,24	4.69	7 (30%)
3	SO4	H	2526	-	4,4,4	0.33	0	6,6,6	0.42	0
4	THM	D	2541	-	18,18,18	1.93	5 (27%)	26,26,26	3.30	11 (42%)
3	SO4	D	2514	-	4,4,4	0.32	0	6,6,6	1.23	1 (16%)
3	SO4	F	2524	-	4,4,4	0.44	0	6,6,6	0.80	0
3	SO4	D	2512	-	4,4,4	0.63	0	6,6,6	0.63	0
2	G1P	C	2502	-	15,16,16	2.07	6 (40%)	23,24,24	3.92	7 (30%)
4	THM	E	2542	-	18,18,18	2.81	10 (55%)	26,26,26	2.39	10 (38%)
4	THM	H	2545	-	18,18,18	2.58	10 (55%)	26,26,26	3.34	10 (38%)
3	SO4	H	2518	-	4,4,4	0.54	0	6,6,6	0.42	0
2	G1P	A	2500	-	15,16,16	1.94	5 (33%)	23,24,24	2.65	7 (30%)
2	G1P	D	2503	-	15,16,16	1.97	4 (26%)	23,24,24	3.71	9 (39%)
3	SO4	F	2519	-	4,4,4	0.38	0	6,6,6	0.62	0
3	SO4	G	2523	-	4,4,4	0.64	0	6,6,6	0.89	0
4	THM	D	2533	-	18,18,18	2.45	5 (27%)	26,26,26	2.62	11 (42%)
3	SO4	B	2510	-	4,4,4	0.11	0	6,6,6	0.55	0
3	SO4	E	2520	-	4,4,4	0.20	0	6,6,6	0.36	0
4	THM	A	2538	-	18,18,18	2.84	10 (55%)	26,26,26	2.65	10 (38%)

In the following table, the Chirals column lists the number of chiral outliers, the number of chiral centers analysed, the number of these observed in the model and the number defined in the Chemical Component Dictionary. Similar counts are reported in the Torsion and Rings columns. '-' means no outliers of that kind were identified.

Mol	Type	Chain	Res	Link	Chirals	Torsions	Rings
4	THM	F	2535	-	-	0/6/18/18	0/2/2/2
2	G1P	H	2506	-	-	1/7/27/27	0/1/1/1
4	THM	C	2540	-	-	0/6/18/18	0/2/2/2
4	THM	B	2531	-	-	0/6/18/18	0/2/2/2
4	THM	A	2530	-	-	0/6/18/18	0/2/2/2
4	THM	G	2544	-	-	0/6/18/18	0/2/2/2
4	THM	B	2539	-	-	0/6/18/18	0/2/2/2
4	THM	C	2532	-	-	0/6/18/18	0/2/2/2
2	G1P	G	2505	-	-	0/7/27/27	0/1/1/1
4	THM	H	2537	-	-	1/6/18/18	0/2/2/2
4	THM	F	2543	-	-	0/6/18/18	0/2/2/2

Continued on next page...

Continued from previous page...

Mol	Type	Chain	Res	Link	Chirals	Torsions	Rings
2	G1P	E	2504	-	-	0/7/27/27	0/1/1/1
4	THM	G	2536	-	-	0/6/18/18	0/2/2/2
4	THM	E	2534	-	-	2/6/18/18	0/2/2/2
2	G1P	B	2501	-	-	0/7/27/27	0/1/1/1
4	THM	A	2538	-	-	0/6/18/18	0/2/2/2
2	G1P	C	2502	-	-	1/7/27/27	0/1/1/1
4	THM	E	2542	-	-	0/6/18/18	0/2/2/2
4	THM	H	2545	-	-	0/6/18/18	0/2/2/2
2	G1P	A	2500	-	-	0/7/27/27	0/1/1/1
2	G1P	D	2503	-	-	0/7/27/27	0/1/1/1
4	THM	D	2533	-	-	1/6/18/18	0/2/2/2
4	THM	D	2541	-	-	0/6/18/18	0/2/2/2

The worst 5 of 146 bond length outliers are listed below:

Mol	Chain	Res	Type	Atoms	Z	Observed(Å)	Ideal(Å)
4	B	2539	THM	O2-C2	7.23	1.36	1.23
4	B	2531	THM	O2-C2	6.52	1.35	1.23
4	D	2533	THM	O4-C4	6.05	1.35	1.23
4	G	2544	THM	O2-C2	5.91	1.33	1.23
4	H	2537	THM	C4-C5	-5.64	1.35	1.44

The worst 5 of 247 bond angle outliers are listed below:

Mol	Chain	Res	Type	Atoms	Z	Observed(°)	Ideal(°)
2	E	2504	G1P	O5-C1-O1	-22.82	81.54	111.36
2	B	2501	G1P	O5-C1-O1	-18.25	87.50	111.36
2	H	2506	G1P	O5-C1-O1	-15.76	90.76	111.36
2	C	2502	G1P	O5-C1-O1	-15.28	91.39	111.36
2	D	2503	G1P	O5-C1-O1	-14.59	92.29	111.36

There are no chirality outliers.

5 of 6 torsion outliers are listed below:

Mol	Chain	Res	Type	Atoms
4	E	2534	THM	O4'-C4'-C5'-O5'
2	C	2502	G1P	O5-C5-C6-O6
4	H	2537	THM	O4'-C4'-C5'-O5'
2	H	2506	G1P	O5-C5-C6-O6
4	D	2533	THM	O4'-C4'-C5'-O5'

There are no ring outliers.

16 monomers are involved in 25 short contacts:

Mol	Chain	Res	Type	Clashes	Symm-Clashes
4	F	2535	THM	2	0
2	H	2506	G1P	1	0
4	A	2530	THM	1	0
2	G	2505	G1P	1	0
4	H	2537	THM	2	0
2	E	2504	G1P	2	0
4	G	2536	THM	1	0
3	A	2507	SO4	3	0
2	B	2501	G1P	2	0
3	H	2526	SO4	1	0
3	F	2524	SO4	1	0
2	C	2502	G1P	2	0
3	H	2518	SO4	1	0
2	A	2500	G1P	2	0
2	D	2503	G1P	2	0
3	E	2520	SO4	1	0

The following is a two-dimensional graphical depiction of Mogul quality analysis of bond lengths, bond angles, torsion angles, and ring geometry for all instances of the Ligand of Interest. In addition, ligands with molecular weight > 250 and outliers as shown on the validation Tables will also be included. For torsion angles, if less than 5% of the Mogul distribution of torsion angles is within 10 degrees of the torsion angle in question, then that torsion angle is considered an outlier. Any bond that is central to one or more torsion angles identified as an outlier by Mogul will be highlighted in the graph. For rings, the root-mean-square deviation (RMSD) between the ring in question and similar rings identified by Mogul is calculated over all ring torsion angles. If the average RMSD is greater than 60 degrees and the minimal RMSD between the ring in question and any Mogul-identified rings is also greater than 60 degrees, then that ring is considered an outlier. The outliers are highlighted in purple. The color gray indicates Mogul did not find sufficient equivalents in the CSD to analyse the geometry.

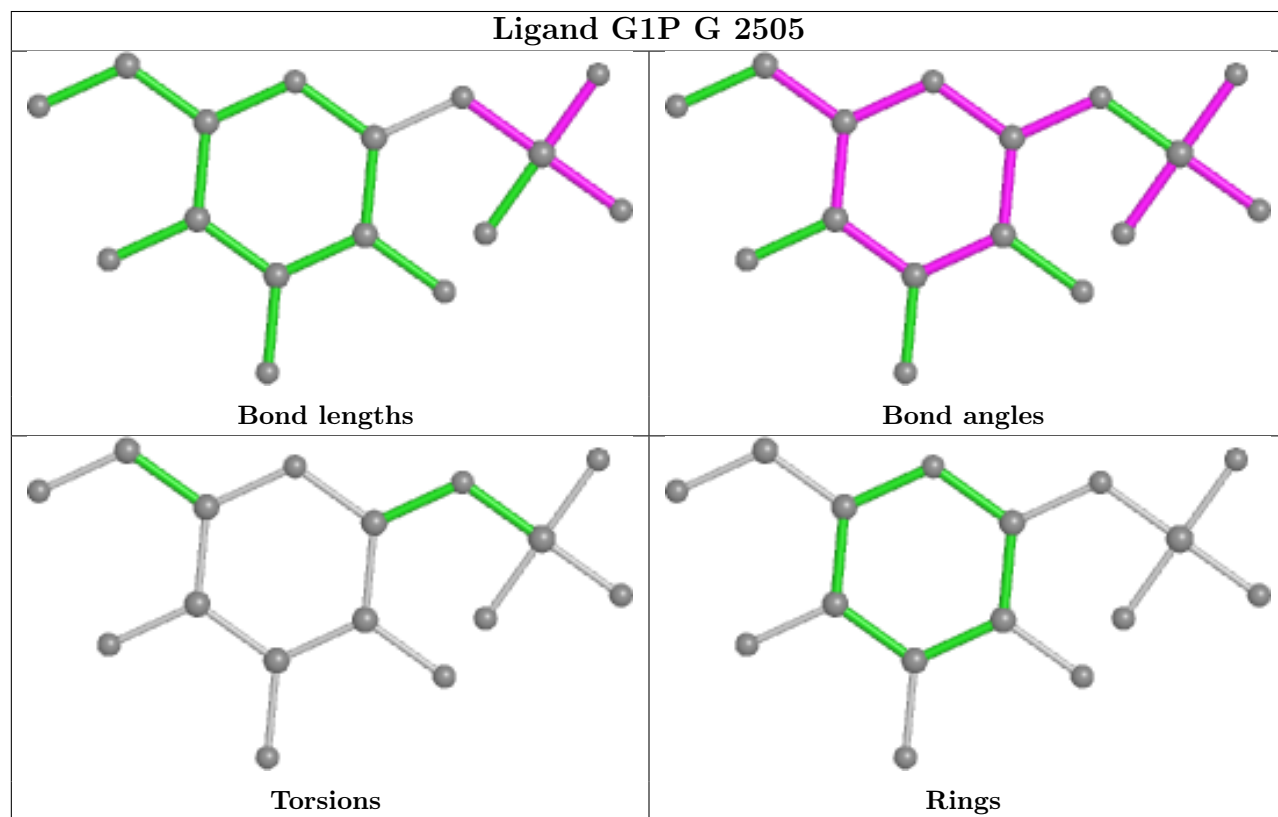
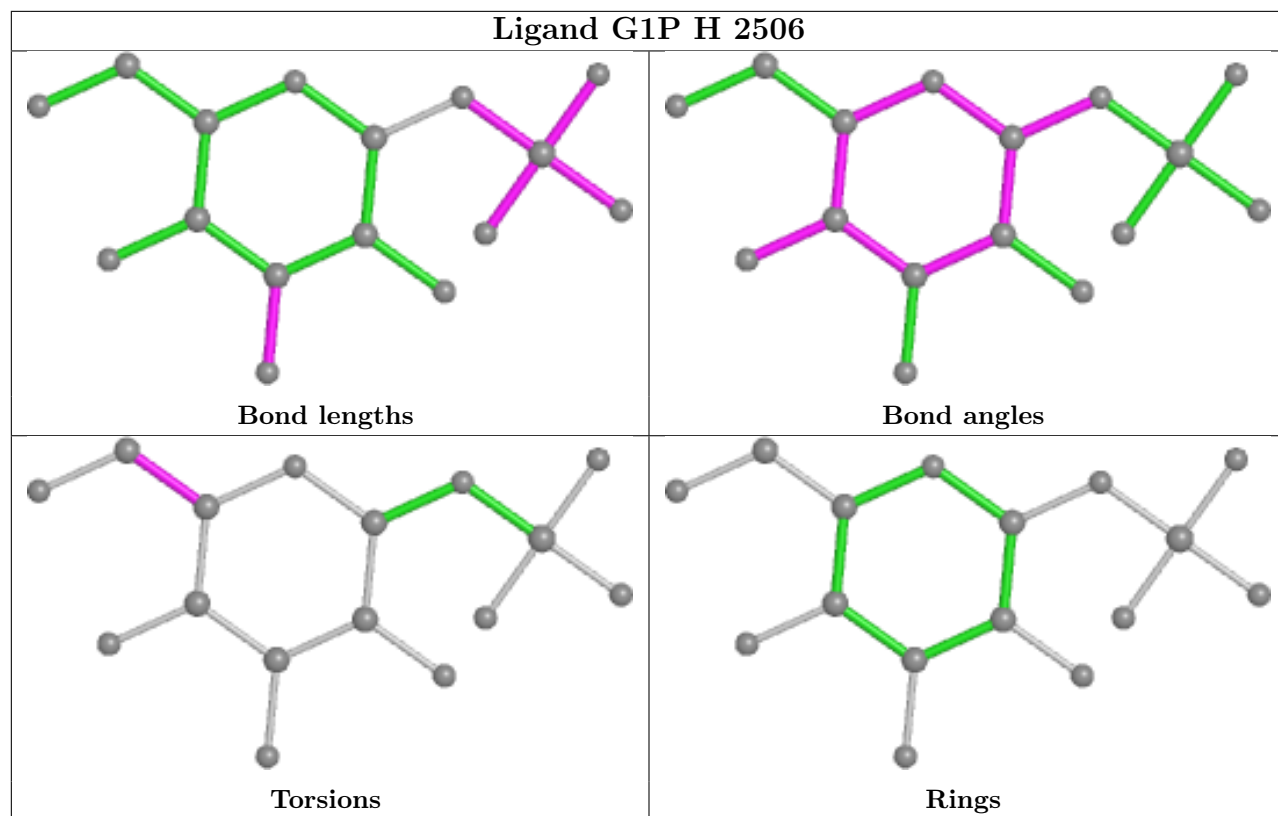

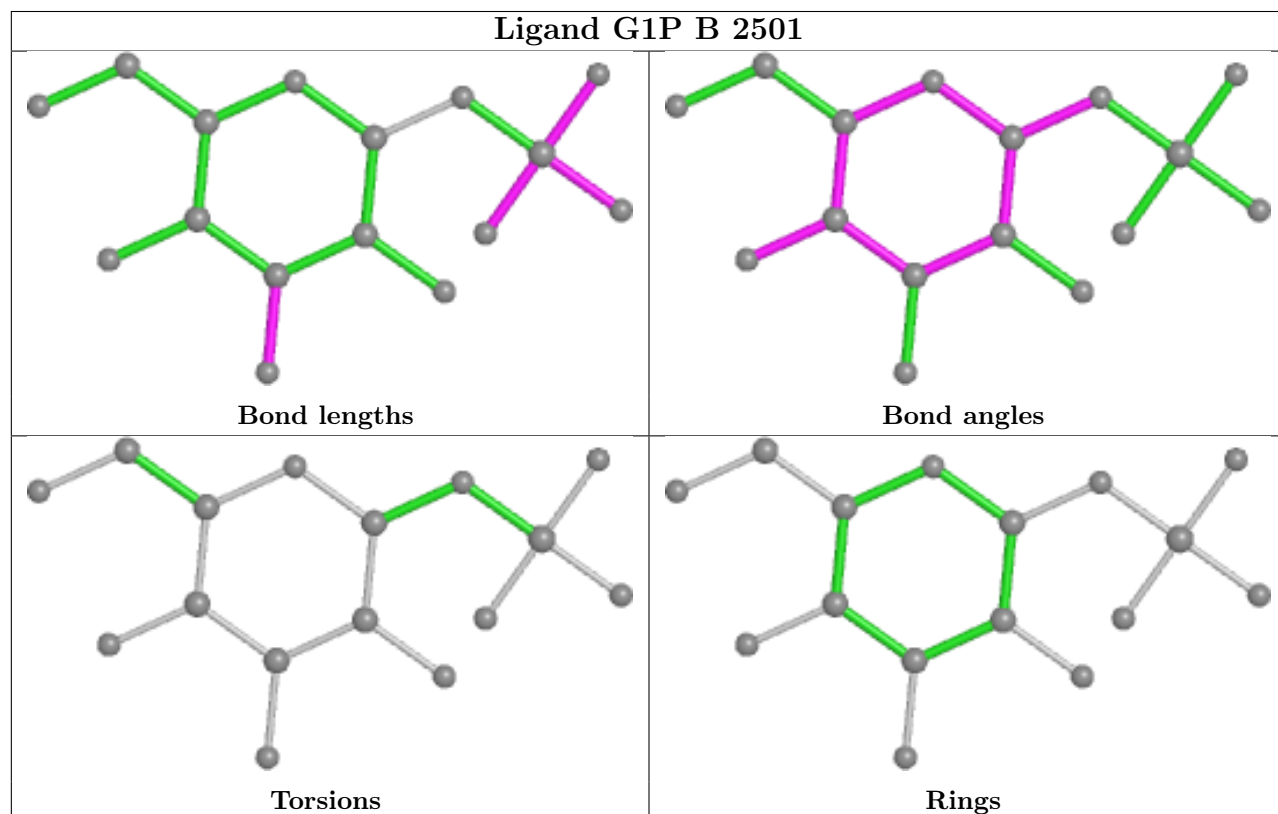
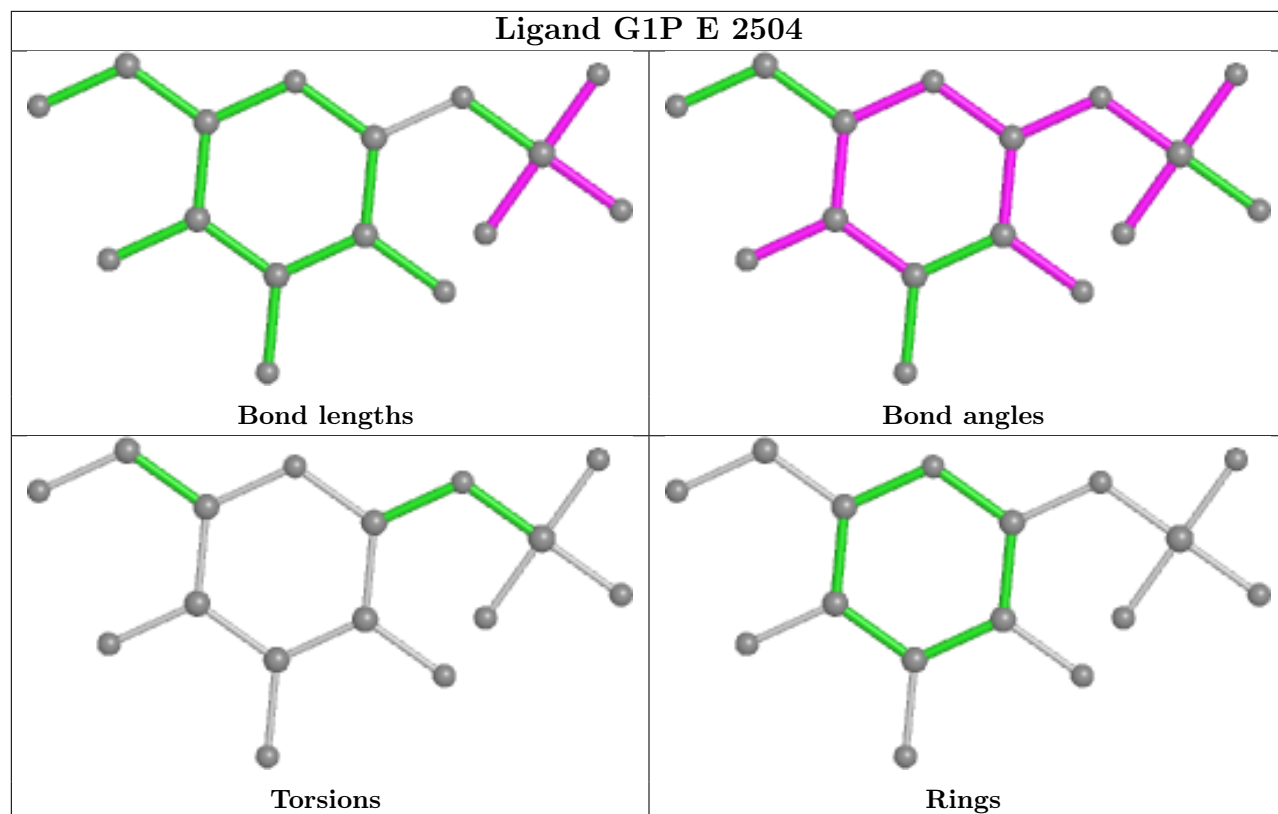



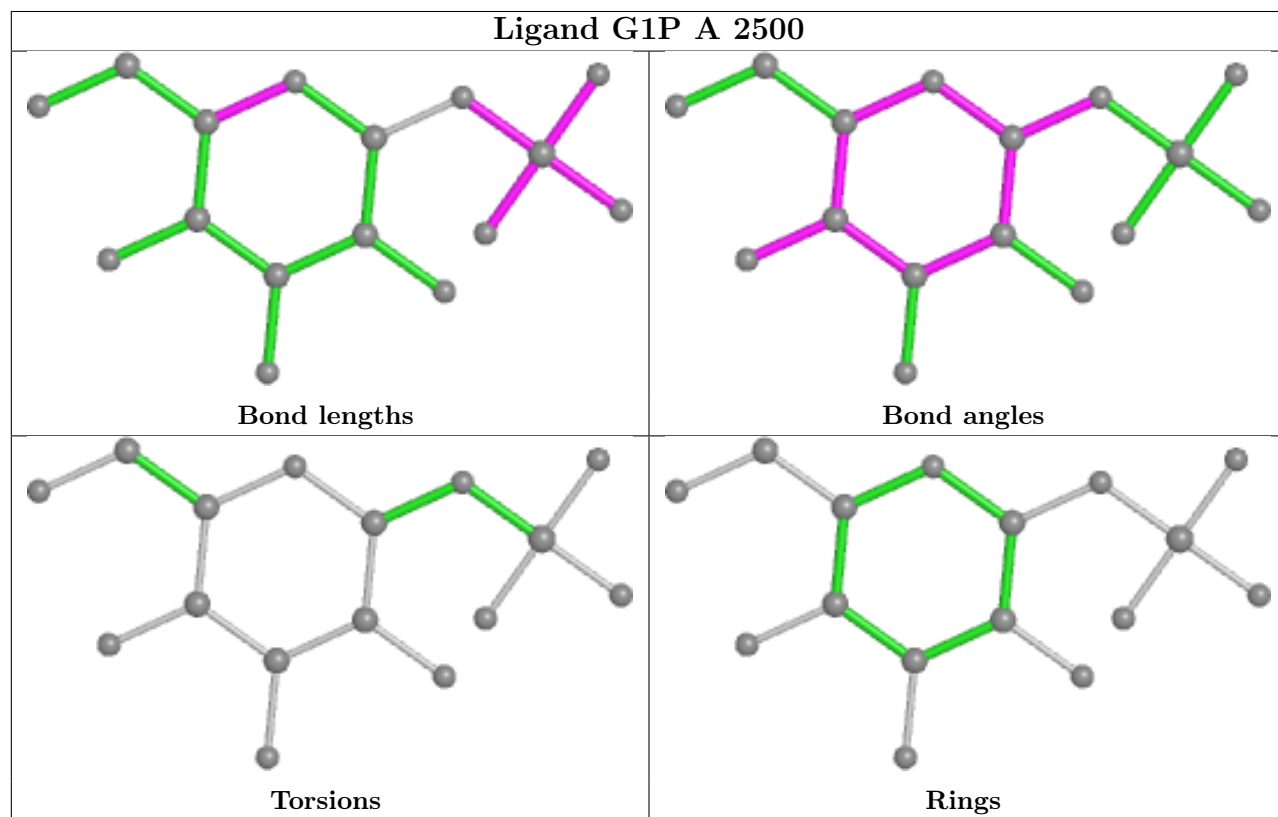
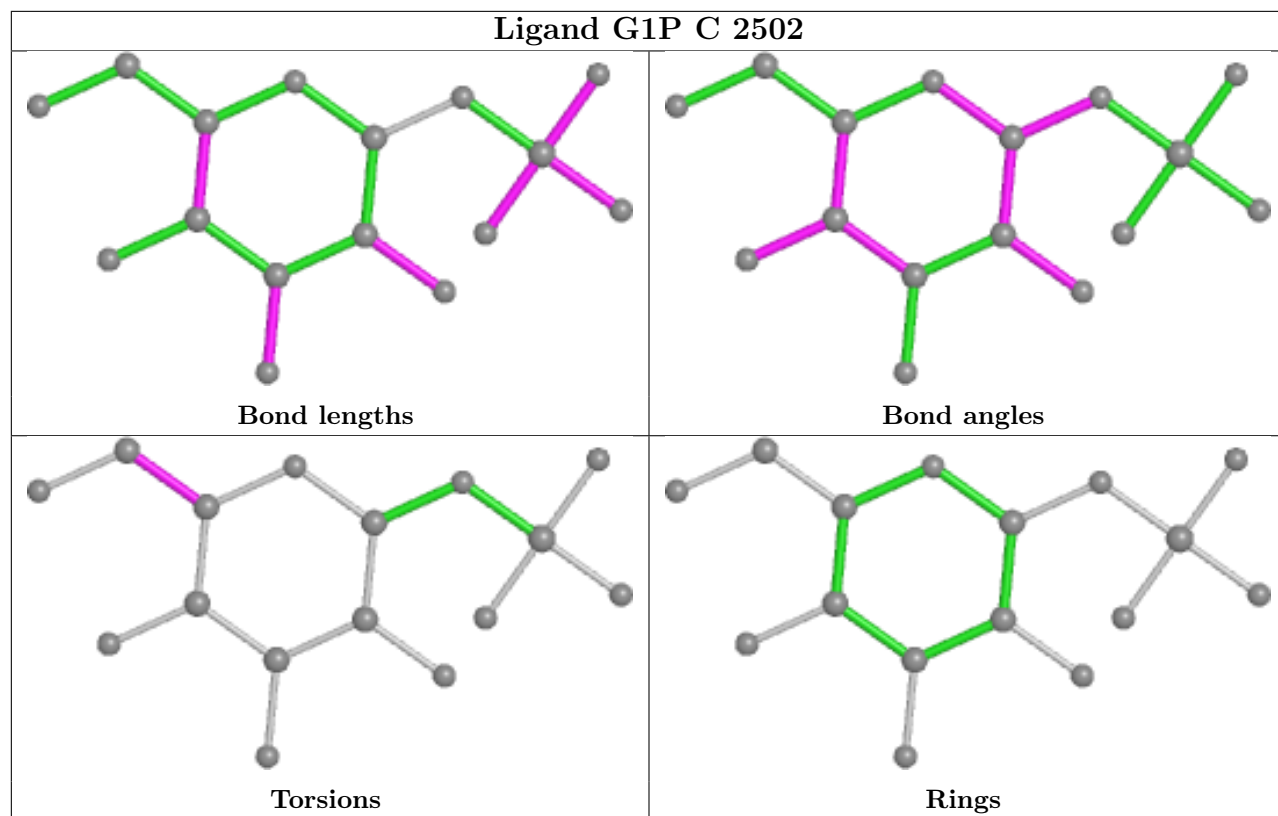

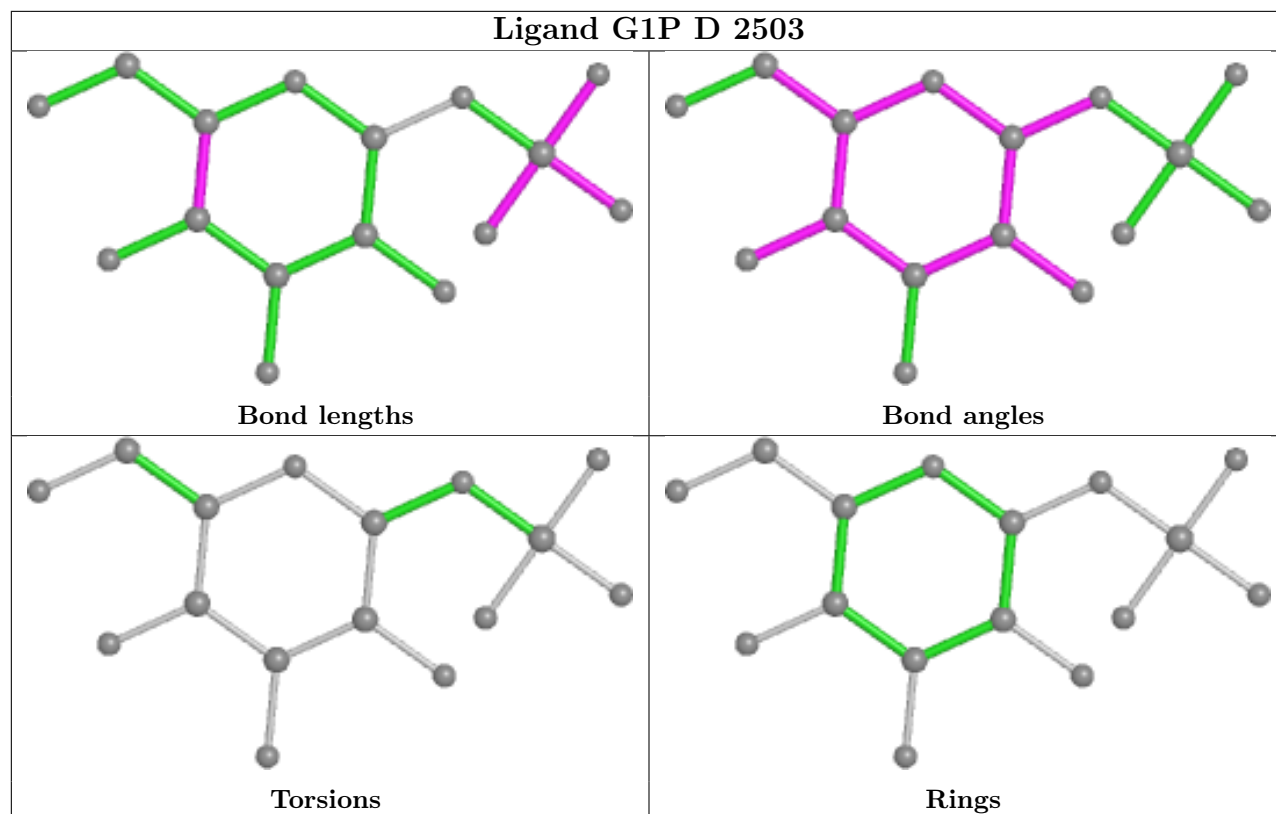

## 5.7 Other polymers [i](#)

There are no such residues in this entry.

## 5.8 Polymer linkage issues [i](#)

There are no chain breaks in this entry.

## 6 Fit of model and data [i](#)

### 6.1 Protein, DNA and RNA chains [i](#)

In the following table, the column labelled ‘#RSRZ > 2’ contains the number (and percentage) of RSRZ outliers, followed by percent RSRZ outliers for the chain as percentile scores relative to all X-ray entries and entries of similar resolution. The OWAB column contains the minimum, median, 95<sup>th</sup> percentile and maximum values of the occupancy-weighted average B-factor per residue. The column labelled ‘Q < 0.9’ lists the number of (and percentage) of residues with an average occupancy less than 0.9.

Mol	Chain	Analysed	<RSRZ>	#RSRZ>2	OWAB(Å <sup>2</sup> )	Q<0.9
1	A	292/293 (99%)	0.03	13 (4%) 33 34	8, 16, 31, 40	0
1	B	292/293 (99%)	-0.09	6 (2%) 63 65	7, 14, 27, 34	0
1	C	292/293 (99%)	-0.03	10 (3%) 45 46	9, 16, 32, 49	0
1	D	292/293 (99%)	0.14	21 (7%) 15 16	9, 18, 36, 57	0
1	E	292/293 (99%)	0.34	25 (8%) 10 11	11, 22, 42, 63	0
1	F	293/293 (100%)	0.01	13 (4%) 34 35	7, 15, 33, 56	0
1	G	292/293 (99%)	-0.08	3 (1%) 82 83	7, 13, 26, 42	0
1	H	292/293 (99%)	-0.02	7 (2%) 59 60	11, 18, 30, 43	0
All	All	2337/2344 (99%)	0.04	98 (4%) 36 37	7, 16, 33, 63	0

The worst 5 of 98 RSRZ outliers are listed below:

Mol	Chain	Res	Type	RSRZ
1	C	14	THR	7.1
1	C	13	GLY	6.7
1	F	13	GLY	6.6
1	F	14	THR	6.5
1	E	195	GLY	6.2

### 6.2 Non-standard residues in protein, DNA, RNA chains [i](#)

There are no non-standard protein/DNA/RNA residues in this entry.

### 6.3 Carbohydrates [i](#)

There are no monosaccharides in this entry.

## 6.4 Ligands i

In the following table, the Atoms column lists the number of modelled atoms in the group and the number defined in the chemical component dictionary. The B-factors column lists the minimum, median, 95<sup>th</sup> percentile and maximum values of B factors of atoms in the group. The column labelled 'Q< 0.9' lists the number of atoms with occupancy less than 0.9.

Mol	Type	Chain	Res	Atoms	RSCC	RSR	B-factors(Å <sup>2</sup> )	Q<0.9
2	G1P	E	2504	16/16	0.81	0.22	34,47,56,59	0
4	THM	E	2534	17/17	0.82	0.15	39,45,50,55	0
2	G1P	B	2501	16/16	0.83	0.20	29,40,44,45	0
3	SO4	A	2507	5/5	0.84	0.23	45,47,50,52	0
3	SO4	F	2519	5/5	0.85	0.18	55,56,57,60	0
2	G1P	D	2503	16/16	0.85	0.14	30,37,41,42	0
2	G1P	C	2502	16/16	0.87	0.15	30,42,48,49	0
4	THM	F	2535	17/17	0.89	0.13	22,30,44,47	0
4	THM	E	2542	17/17	0.91	0.14	26,30,32,32	0
3	SO4	H	2529	5/5	0.92	0.25	45,45,50,51	0
4	THM	D	2533	17/17	0.93	0.10	27,30,35,37	0
2	G1P	H	2506	16/16	0.93	0.12	29,34,41,42	0
4	THM	B	2531	17/17	0.93	0.11	19,24,33,35	0
4	THM	B	2539	17/17	0.93	0.12	21,24,25,28	0
4	THM	F	2543	17/17	0.93	0.15	19,23,26,27	0
4	THM	A	2538	17/17	0.94	0.13	19,22,25,27	0
3	SO4	G	2525	5/5	0.94	0.34	45,46,47,52	0
2	G1P	G	2505	16/16	0.94	0.11	26,32,37,38	0
4	THM	C	2532	17/17	0.94	0.11	24,30,38,45	0
4	THM	C	2540	17/17	0.94	0.12	20,22,25,26	0
4	THM	H	2537	17/17	0.94	0.12	20,26,33,39	0
4	THM	H	2545	17/17	0.94	0.12	19,25,27,31	0
4	THM	A	2530	17/17	0.95	0.11	24,29,32,38	0
3	SO4	B	2510	5/5	0.95	0.27	40,48,51,53	0
3	SO4	C	2515	5/5	0.95	0.28	40,48,51,52	0
4	THM	G	2536	17/17	0.95	0.10	20,24,29,29	0
4	THM	G	2544	17/17	0.95	0.13	17,22,25,27	0
4	THM	D	2541	17/17	0.95	0.12	19,21,24,24	0
3	SO4	E	2520	5/5	0.95	0.31	45,46,52,56	0
2	G1P	A	2500	16/16	0.96	0.10	28,30,40,40	0
3	SO4	F	2522	5/5	0.96	0.27	39,45,48,53	0
3	SO4	D	2514	5/5	0.97	0.10	48,50,51,52	0
3	SO4	D	2512	5/5	0.97	0.14	38,42,43,45	0
3	SO4	F	2524	5/5	0.97	0.10	36,38,41,42	0
3	SO4	B	2528	5/5	0.98	0.09	39,41,43,43	0
3	SO4	H	2518	5/5	0.98	0.09	24,24,26,26	0
3	SO4	H	2526	5/5	0.98	0.10	39,41,42,43	0

*Continued on next page...*

Continued from previous page...

Mol	Type	Chain	Res	Atoms	RSCC	RSR	B-factors( $\text{\AA}^2$ )	Q<0.9
3	SO4	D	2517	5/5	0.98	0.20	45,48,52,56	0
3	SO4	F	2521	5/5	0.99	0.09	19,20,23,26	0
3	SO4	C	2509	5/5	0.99	0.12	31,37,40,45	0
3	SO4	D	2516	5/5	0.99	0.09	18,22,23,25	0
3	SO4	G	2523	5/5	0.99	0.09	19,20,23,27	0
3	SO4	C	2513	5/5	0.99	0.08	21,22,24,25	0
3	SO4	B	2511	5/5	0.99	0.11	20,21,26,26	0
3	SO4	E	2527	5/5	0.99	0.09	22,23,24,26	0
3	SO4	A	2508	5/5	0.99	0.10	22,23,24,24	0

The following is a graphical depiction of the model fit to experimental electron density of all instances of the Ligand of Interest. In addition, ligands with molecular weight > 250 and outliers as shown on the geometry validation Tables will also be included. Each fit is shown from different orientation to approximate a three-dimensional view.

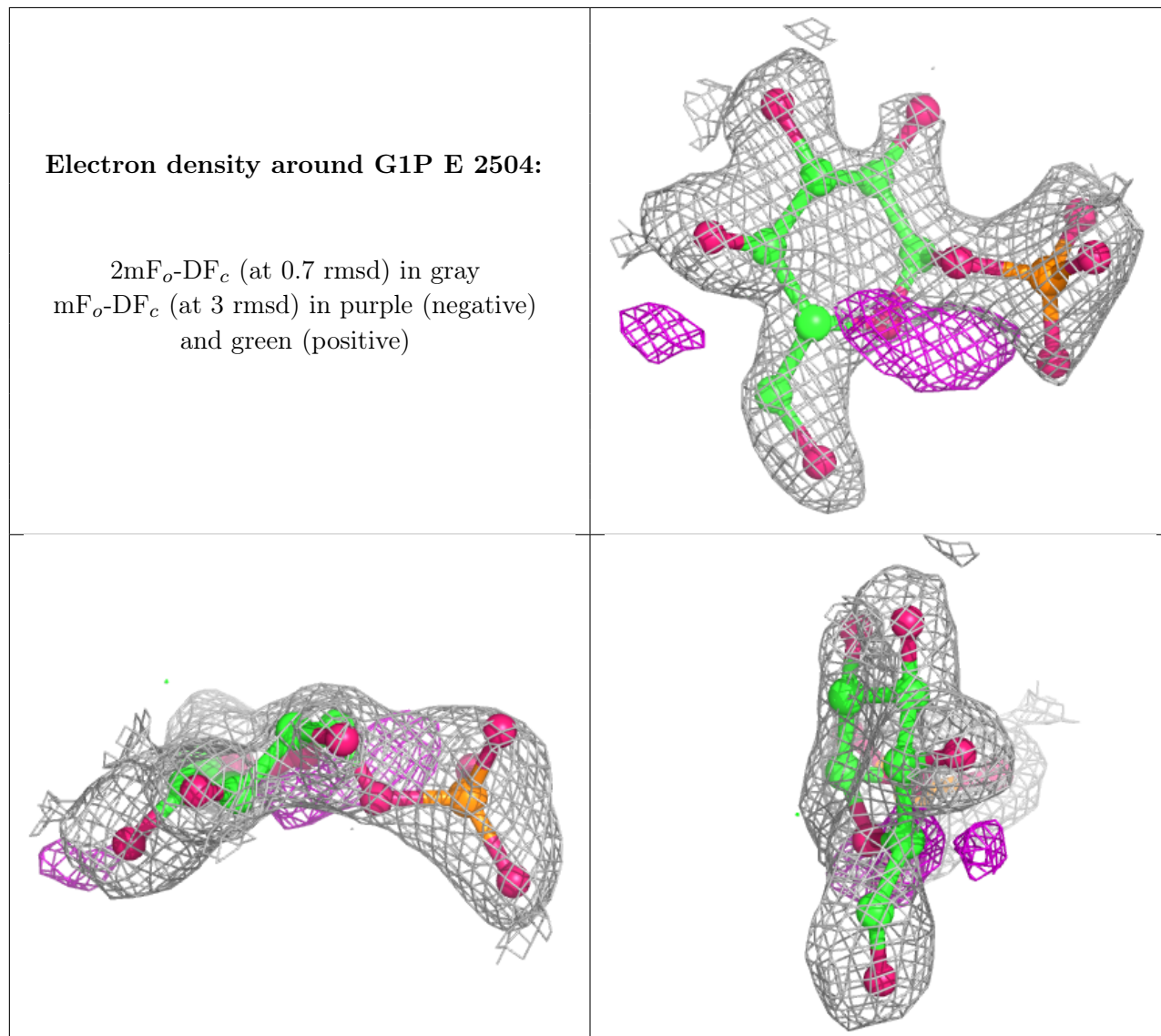

**Electron density around G1P B 2501:**

$2mF_o-DF_c$  (at 0.7 rmsd) in gray  
 $mF_o-DF_c$  (at 3 rmsd) in purple (negative)  
and green (positive)

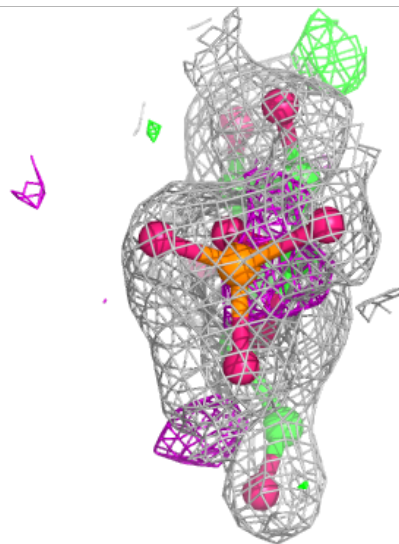
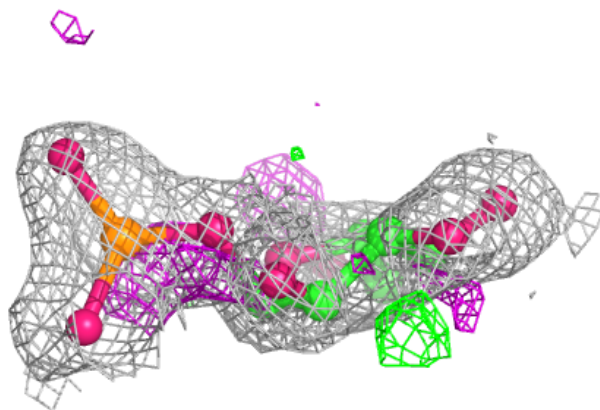
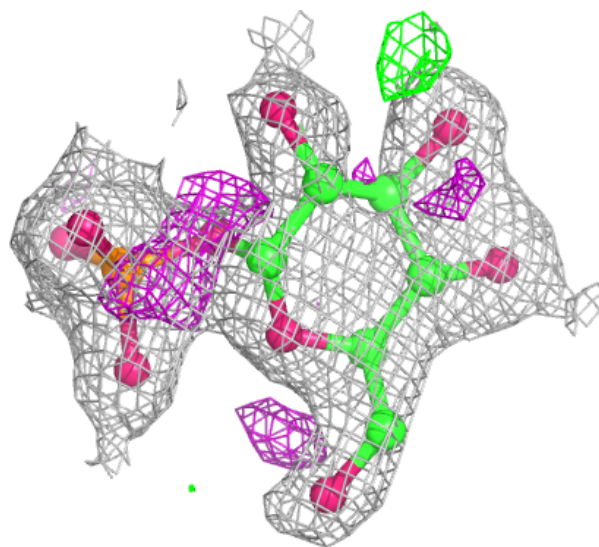



**Electron density around G1P D 2503:**

$2mF_o-DF_c$  (at 0.7 rmsd) in gray  
 $mF_o-DF_c$  (at 3 rmsd) in purple (negative)  
and green (positive)

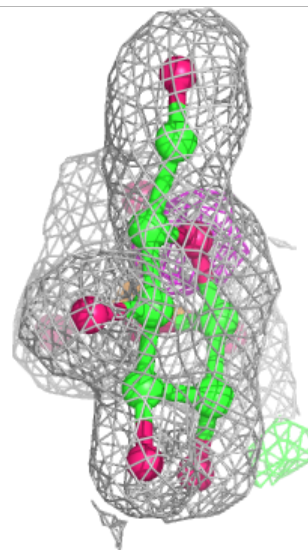
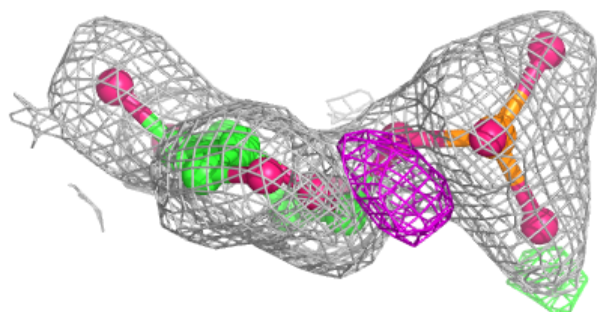
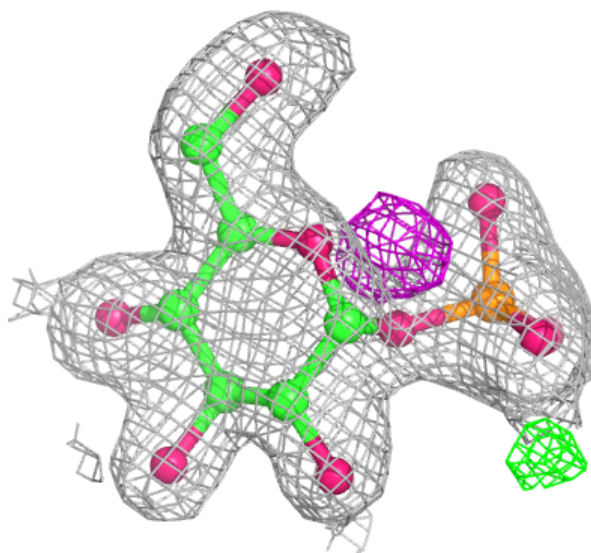

**Electron density around G1P C 2502:**

$2mF_o-DF_c$  (at 0.7 rmsd) in gray  
 $mF_o-DF_c$  (at 3 rmsd) in purple (negative)  
and green (positive)

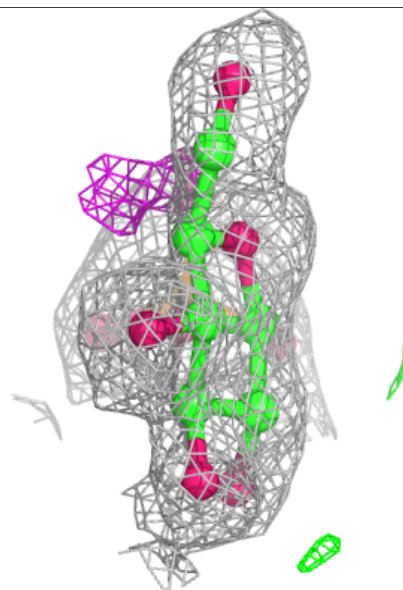
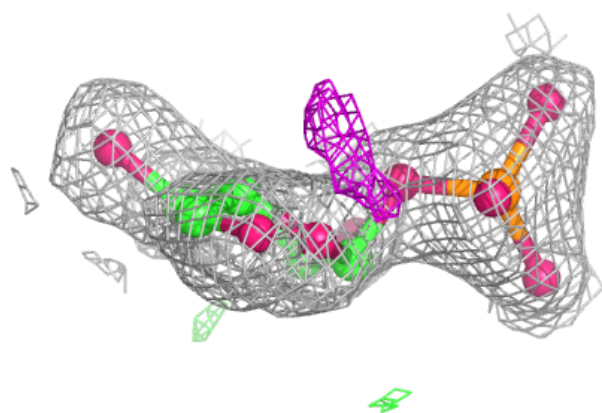
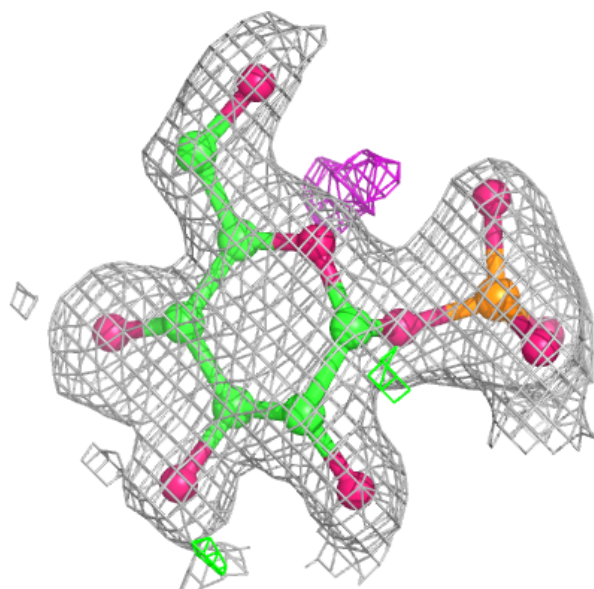



**Electron density around G1P H 2506:**

$2mF_o-DF_c$  (at 0.7 rmsd) in gray  
 $mF_o-DF_c$  (at 3 rmsd) in purple (negative)  
and green (positive)

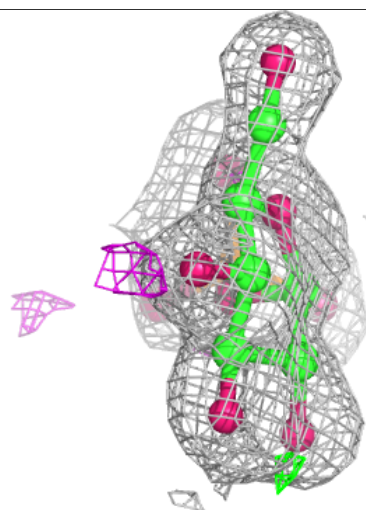
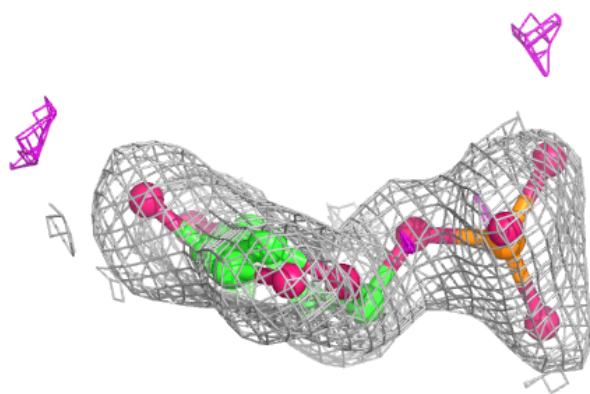
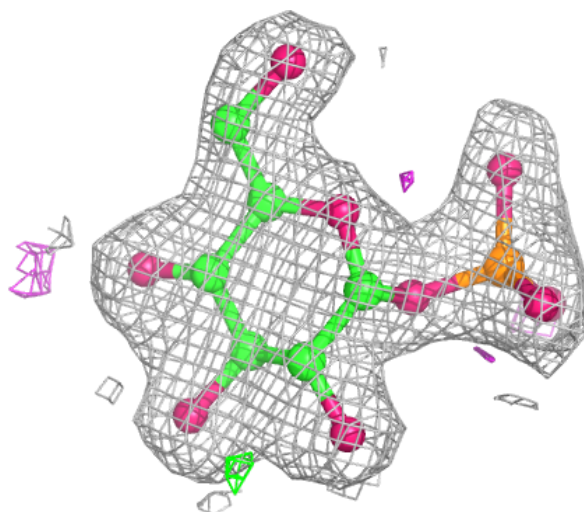

**Electron density around G1P G 2505:**

$2mF_o-DF_c$  (at 0.7 rmsd) in gray  
 $mF_o-DF_c$  (at 3 rmsd) in purple (negative)  
and green (positive)

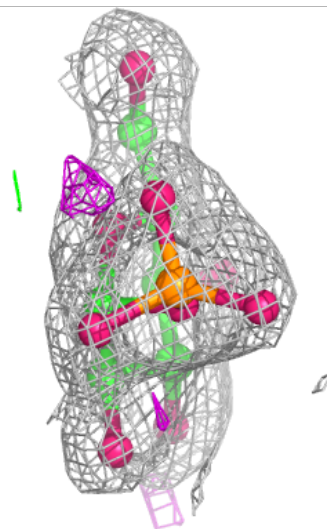
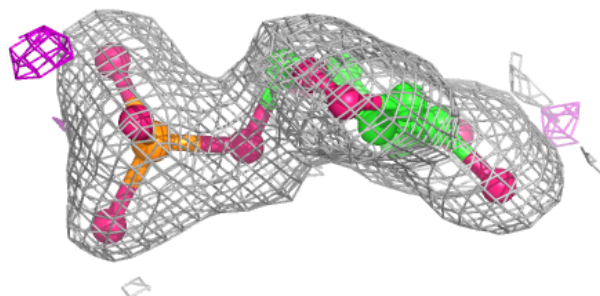
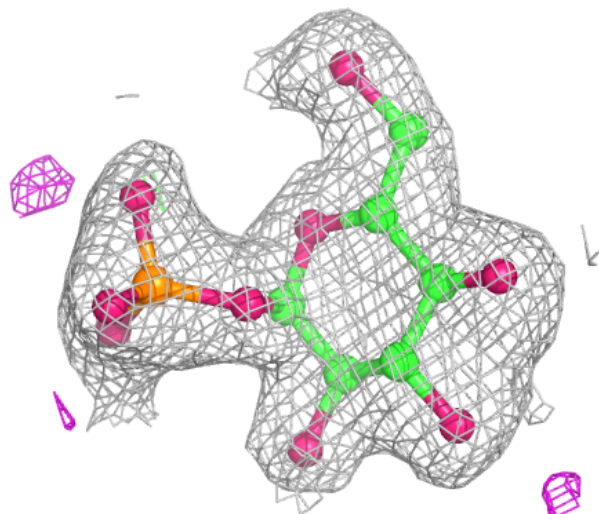

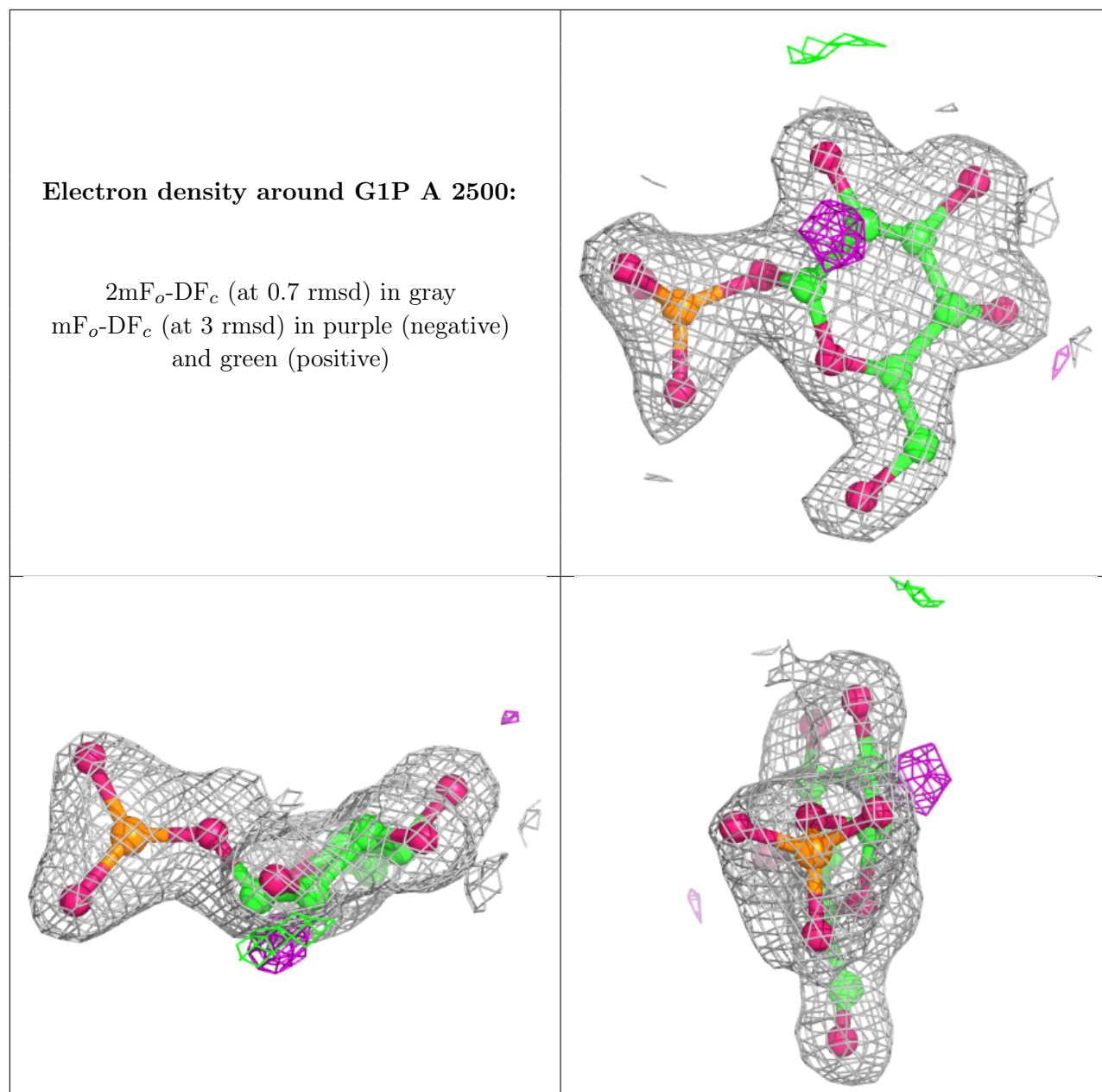

## 6.5 Other polymers [i](#)

There are no such residues in this entry.