



wwPDB X-ray Structure Validation Summary Report ⓘ

May 22, 2020 – 02:05 pm BST

PDB ID : 5E8N
Title : The structure of the TEIPP associated Trh4 peptide in complex with H-2D(b)
Authors : Hafstrand, I.; Doorduijn, E.; Duru, A.D.; Buratto, J.; Oliveira, C.C.; Sandalova, T.; van Hall, T.; Achour, A.
Deposited on : 2015-10-14
Resolution : 2.25 Å(reported)

This is a wwPDB X-ray Structure Validation Summary Report for a publicly released PDB entry.

We welcome your comments at validation@mail.wwpdb.org

A user guide is available at

<https://www.wwpdb.org/validation/2017/XrayValidationReportHelp>

with specific help available everywhere you see the ⓘ symbol.

The following versions of software and data (see [references ⓘ](#)) were used in the production of this report:

MolProbity : 4.02b-467
Mogul : 1.8.5 (274361), CSD as541be (2020)
Xtriage (Phenix) : 1.13
EDS : 2.11
Percentile statistics : 20191225.v01 (using entries in the PDB archive December 25th 2019)
Refmac : 5.8.0158
CCP4 : 7.0.044 (Gargrove)
Ideal geometry (proteins) : Engh & Huber (2001)
Ideal geometry (DNA, RNA) : Parkinson et al. (1996)
Validation Pipeline (wwPDB-VP) : 2.11

1 Overall quality at a glance

The following experimental techniques were used to determine the structure:

X-RAY DIFFRACTION

The reported resolution of this entry is 2.25 Å.

Percentile scores (ranging between 0-100) for global validation metrics of the entry are shown in the following graphic. The table shows the number of entries on which the scores are based.

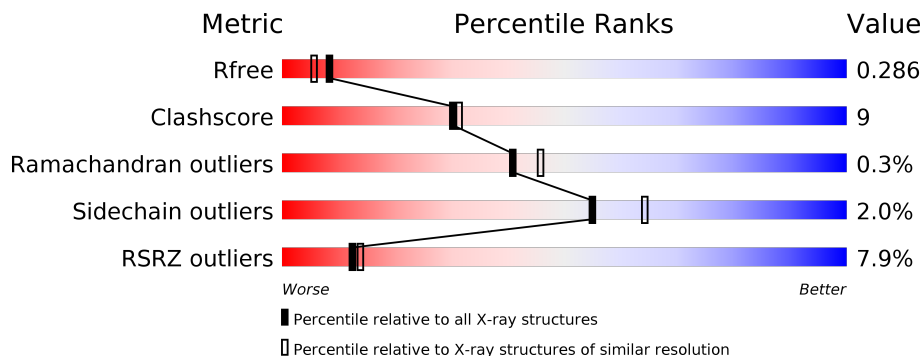







Metric	Whole archive (#Entries)	Similar resolution (#Entries, resolution range(Å))
R_{free}	130704	1377 (2.26-2.26)
Clashscore	141614	1487 (2.26-2.26)
Ramachandran outliers	138981	1449 (2.26-2.26)
Sidechain outliers	138945	1450 (2.26-2.26)
RSRZ outliers	127900	1356 (2.26-2.26)

The table below summarises the geometric issues observed across the polymeric chains and their fit to the electron density. The red, orange, yellow and green segments on the lower bar indicate the fraction of residues that contain outliers for ≥ 3 , 2, 1 and 0 types of geometric quality criteria respectively. A grey segment represents the fraction of residues that are not modelled. The numeric value for each fraction is indicated below the corresponding segment, with a dot representing fractions $\leq 5\%$. The upper red bar (where present) indicates the fraction of residues that have poor fit to the electron density. The numeric value is given above the bar.

Mol	Chain	Length	Quality of chain
1	A	276	 9% 76% 22% ..
1	D	276	 9% 77% 21% .
1	G	276	 7% 79% 18% .
1	J	276	 15% 68% 23% . 7%
2	B	99	 % 88% 12%
2	E	99	 % 86% 14%

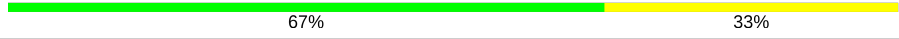
Continued on next page...

Continued from previous page...

Mol	Chain	Length	Quality of chain
2	H	99	 <p>% 85% 15%</p>
2	K	99	 <p>7% 74% 23%</p>
3	C	9	 <p>67% 33%</p>
3	F	9	 <p>78% 22%</p>
3	I	9	 <p>67% 33%</p>
3	L	9	 <p>22% 78%</p>

2 Entry composition [i](#)

There are 6 unique types of molecules in this entry. The entry contains 12495 atoms, of which 0 are hydrogens and 0 are deuteriums.

In the tables below, the ZeroOcc column contains the number of atoms modelled with zero occupancy, the AltConf column contains the number of residues with at least one atom in alternate conformation and the Trace column contains the number of residues modelled with at most 2 atoms.

- Molecule 1 is a protein called H-2 class I histocompatibility antigen, D-B alpha chain.

Mol	Chain	Residues	Atoms					ZeroOcc	AltConf	Trace
			Total	C	N	O	S			
1	A	272	Total 2227	C 1408	N 391	O 419	S 9	0	0	0
1	D	272	Total 2237	C 1410	N 397	O 421	S 9	0	1	0
1	G	269	Total 2208	C 1394	N 389	O 416	S 9	0	1	0
1	J	258	Total 2113	C 1338	N 368	O 399	S 8	0	0	0

- Molecule 2 is a protein called Beta-2-microglobulin.

Mol	Chain	Residues	Atoms					ZeroOcc	AltConf	Trace
			Total	C	N	O	S			
2	B	99	Total 825	C 526	N 138	O 153	S 8	0	1	0
2	E	99	Total 821	C 523	N 137	O 153	S 8	0	1	0
2	H	99	Total 825	C 526	N 138	O 153	S 8	0	1	0
2	K	99	Total 817	C 520	N 136	O 153	S 8	0	1	0

There are 4 discrepancies between the modelled and reference sequences:

Chain	Residue	Modelled	Actual	Comment	Reference
B	85	ASP	ALA	conflict	UNP P01887
E	85	ASP	ALA	conflict	UNP P01887
H	85	ASP	ALA	conflict	UNP P01887
K	85	ASP	ALA	conflict	UNP P01887

- Molecule 3 is a protein called Ceramide synthase 5.

Mol	Chain	Residues	Atoms				ZeroOcc	AltConf	Trace	
3	C	9	Total	C	N	O	S	0	0	0
			69	42	12	11	4			
3	F	9	Total	C	N	O	S	0	0	0
			69	42	12	11	4			
3	I	9	Total	C	N	O	S	0	0	0
			69	42	12	11	4			
3	L	9	Total	C	N	O	S	0	0	0
			69	42	12	11	4			

- Molecule 4 is GLYCEROL (three-letter code: GOL) (formula: C₃H₈O₃).

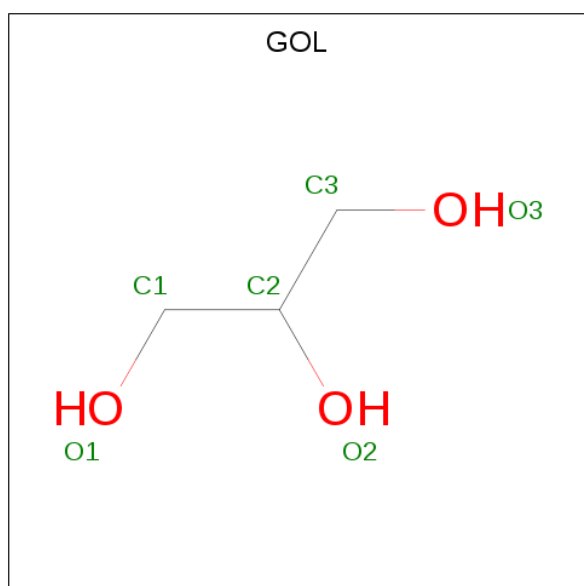

Mol	Chain	Residues	Atoms		ZeroOcc	AltConf
4	B	1	Total	C O	0	0
			6	3 3		

- Molecule 5 is SULFATE ION (three-letter code: SO4) (formula: O₄S).



Mol	Chain	Residues	Atoms			ZeroOcc	AltConf
5	G	1	Total	O	S	0	0
			5	4	1		

- Molecule 6 is water.

Mol	Chain	Residues	Atoms		ZeroOcc	AltConf
6	A	18	Total	O	0	0
			18	18		
6	B	22	Total	O	0	0
			22	22		
6	C	5	Total	O	0	0
			5	5		
6	D	22	Total	O	0	0
			22	22		
6	E	13	Total	O	0	0
			13	13		
6	F	5	Total	O	0	0
			5	5		
6	G	10	Total	O	0	0
			10	10		
6	H	17	Total	O	0	0
			17	17		
6	J	20	Total	O	0	0
			20	20		
6	K	1	Total	O	0	0
			1	1		
6	L	2	Total	O	0	0
			2	2		

3 Residue-property plots [i](#)

These plots are drawn for all protein, RNA and DNA chains in the entry. The first graphic for a chain summarises the proportions of the various outlier classes displayed in the second graphic. The second graphic shows the sequence view annotated by issues in geometry and electron density. Residues are color-coded according to the number of geometric quality criteria for which they contain at least one outlier: green = 0, yellow = 1, orange = 2 and red = 3 or more. A red dot above a residue indicates a poor fit to the electron density ($RSRZ > 2$). Stretches of 2 or more consecutive residues without any outlier are shown as a green connector. Residues present in the sample, but not in the model, are shown in grey.

- Molecule 1: H-2 class I histocompatibility antigen, D-B alpha chain

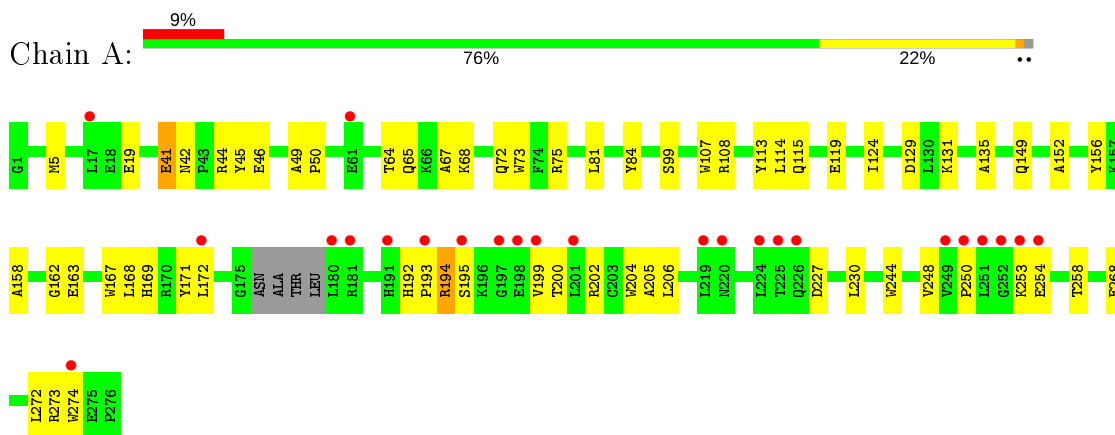

- Molecule 1: H-2 class I histocompatibility antigen, D-B alpha chain

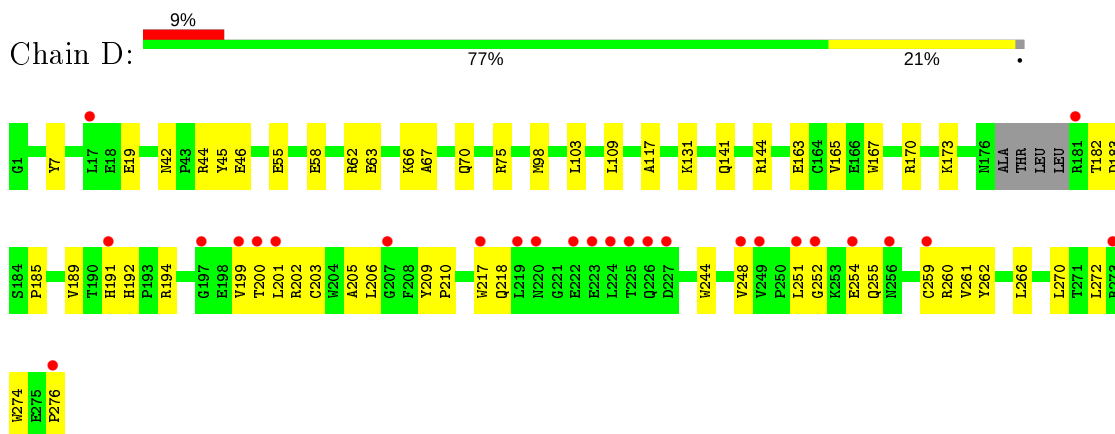

- Molecule 1: H-2 class I histocompatibility antigen, D-B alpha chain

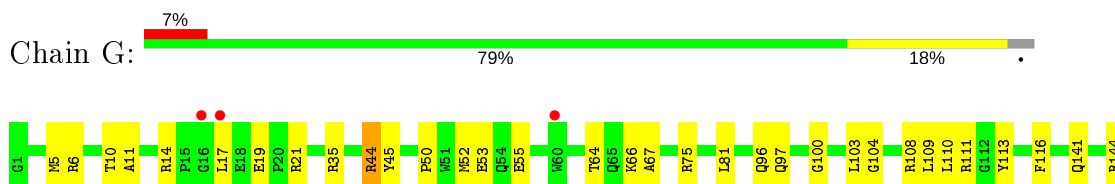

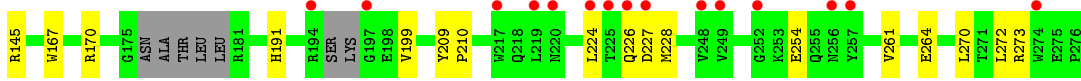

- Molecule 1: H-2 class I histocompatibility antigen, D-B alpha chain

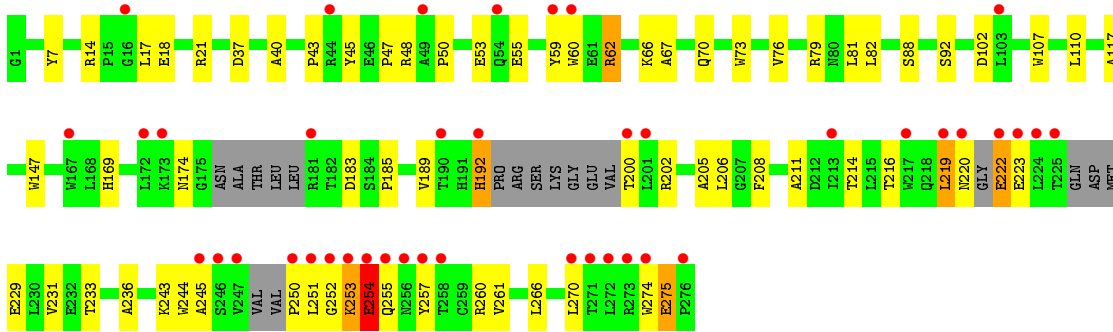

- Molecule 2: Beta-2-microglobulin

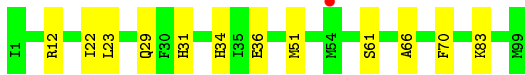
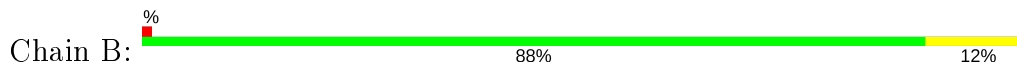

- Molecule 2: Beta-2-microglobulin

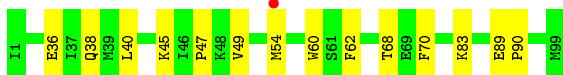
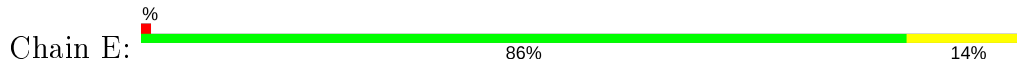

- Molecule 2: Beta-2-microglobulin

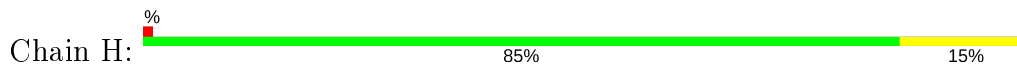

- Molecule 2: Beta-2-microglobulin

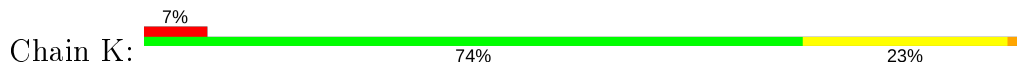

- Molecule 3: Ceramide synthase 5

Chain C:  67% 33%



- Molecule 3: Ceramide synthase 5

Chain F:  78% 22%



- Molecule 3: Ceramide synthase 5

Chain I:  67% 33%



- Molecule 3: Ceramide synthase 5

Chain L:  22% 78%



4 Data and refinement statistics

Property	Value	Source
Space group	P 1 21 1	Depositor
Cell constants a, b, c, α , β , γ	92.51Å 124.25Å 99.29Å 90.00° 103.26° 90.00°	Depositor
Resolution (Å)	52.26 – 2.25 52.26 – 2.25	Depositor EDS
% Data completeness (in resolution range)	98.8 (52.26-2.25) 98.9 (52.26-2.25)	Depositor EDS
R_{merge}	0.08	Depositor
R_{sym}	(Not available)	Depositor
$\langle I/\sigma(I) \rangle$ ¹	2.13 (at 2.25Å)	Xtrriage
Refinement program	PHENIX (1.10_2155: ???)	Depositor
R, R_{free}	0.239 , 0.286 0.239 , 0.286	Depositor DCC
R_{free} test set	5031 reflections (4.92%)	wwPDB-VP
Wilson B-factor (Å ²)	39.4	Xtrriage
Anisotropy	0.228	Xtrriage
Bulk solvent k_{sol} (e/Å ³), B_{sol} (Å ²)	0.34 , 43.4	EDS
L-test for twinning ²	$\langle L \rangle = 0.44$, $\langle L^2 \rangle = 0.27$	Xtrriage
Estimated twinning fraction	No twinning to report.	Xtrriage
F_o, F_c correlation	0.92	EDS
Total number of atoms	12495	wwPDB-VP
Average B, all atoms (Å ²)	51.0	wwPDB-VP

Xtrriage's analysis on translational NCS is as follows: *The largest off-origin peak in the Patterson function is 8.73% of the height of the origin peak. No significant pseudotranslation is detected.*

¹Intensities estimated from amplitudes.

²Theoretical values of $\langle |L| \rangle$, $\langle L^2 \rangle$ for acentric reflections are 0.5, 0.333 respectively for untwinned datasets, and 0.375, 0.2 for perfectly twinned datasets.

5 Model quality [i](#)

5.1 Standard geometry [i](#)

Bond lengths and bond angles in the following residue types are not validated in this section: GOL, SO4

The Z score for a bond length (or angle) is the number of standard deviations the observed value is removed from the expected value. A bond length (or angle) with $|Z| > 5$ is considered an outlier worth inspection. RMSZ is the root-mean-square of all Z scores of the bond lengths (or angles).

Mol	Chain	Bond lengths		Bond angles	
		RMSZ	# Z >5	RMSZ	# Z >5
1	A	0.48	0/2293	0.65	1/3112 (0.0%)
1	D	0.49	0/2306	0.62	0/3129
1	G	0.42	0/2276	0.60	1/3089 (0.0%)
1	J	0.50	2/2173 (0.1%)	0.65	3/2945 (0.1%)
2	B	0.53	0/851	0.65	0/1154
2	E	0.48	0/847	0.66	0/1150
2	H	0.46	0/851	0.63	0/1154
2	K	0.44	0/843	0.66	0/1146
3	C	0.68	0/68	0.81	0/87
3	F	0.57	0/68	0.78	0/87
3	I	0.50	0/68	0.69	0/87
3	L	0.56	0/68	0.88	0/87
All	All	0.47	2/12712 (0.0%)	0.64	5/17227 (0.0%)

All (2) bond length outliers are listed below:

Mol	Chain	Res	Type	Atoms	Z	Observed(Å)	Ideal(Å)
1	J	275	GLU	CD-OE1	-6.01	1.19	1.25
1	J	18	GLU	C-N	5.41	1.46	1.34

All (5) bond angle outliers are listed below:

Mol	Chain	Res	Type	Atoms	Z	Observed(°)	Ideal(°)
1	A	172	LEU	CA-CB-CG	7.99	133.67	115.30
1	J	62	ARG	NE-CZ-NH1	6.50	123.55	120.30
1	J	62	ARG	NE-CZ-NH2	-6.04	117.28	120.30
1	G	145	ARG	NE-CZ-NH1	-5.61	117.49	120.30
1	J	82	LEU	CA-CB-CG	5.03	126.86	115.30

There are no chirality outliers.

There are no planarity outliers.

5.2 Too-close contacts [i](#)

In the following table, the Non-H and H(model) columns list the number of non-hydrogen atoms and hydrogen atoms in the chain respectively. The H(added) column lists the number of hydrogen atoms added and optimized by MolProbity. The Clashes column lists the number of clashes within the asymmetric unit, whereas Symm-Clashes lists symmetry related clashes.

Mol	Chain	Non-H	H(model)	H(added)	Clashes	Symm-Clashes
1	A	2227	0	2089	44	0
1	D	2237	0	2089	49	0
1	G	2208	0	2053	34	0
1	J	2113	0	1956	62	1
2	B	825	0	793	8	0
2	E	821	0	782	12	0
2	H	825	0	793	8	1
2	K	817	0	771	18	0
3	C	69	0	79	3	0
3	F	69	0	79	3	0
3	I	69	0	79	3	0
3	L	69	0	79	9	0
4	B	6	0	8	2	0
5	G	5	0	0	0	0
6	A	18	0	0	2	0
6	B	22	0	0	1	0
6	C	5	0	0	0	0
6	D	22	0	0	0	0
6	E	13	0	0	0	0
6	F	5	0	0	0	0
6	G	10	0	0	0	0
6	H	17	0	0	0	0
6	J	20	0	0	2	0
6	K	1	0	0	0	0
6	L	2	0	0	0	0
All	All	12495	0	11650	224	1

The all-atom clashscore is defined as the number of clashes found per 1000 atoms (including hydrogen atoms). The all-atom clashscore for this structure is 9.

The worst 5 of 224 close contacts within the same asymmetric unit are listed below, sorted by their clash magnitude.

Atom-1	Atom-2	Interatomic distance (Å)	Clash overlap (Å)
1:J:253:LYS:HD3	1:J:257:TYR:CE2	1.03	1.56
1:J:253:LYS:CD	1:J:257:TYR:CE2	1.87	1.52
1:J:253:LYS:CD	1:J:257:TYR:HE2	1.39	1.06
1:J:253:LYS:HD3	1:J:257:TYR:CD2	1.92	1.04
1:J:253:LYS:CD	1:J:257:TYR:CD2	2.40	1.04

All (1) symmetry-related close contacts are listed below. The label for Atom-2 includes the symmetry operator and encoded unit-cell translations to be applied.

Atom-1	Atom-2	Interatomic distance (Å)	Clash overlap (Å)
2:H:88:ALA:O	1:J:62:ARG:NH1[2_658]	2.16	0.04

5.3 Torsion angles [i](#)

5.3.1 Protein backbone [i](#)

In the following table, the Percentiles column shows the percent Ramachandran outliers of the chain as a percentile score with respect to all X-ray entries followed by that with respect to entries of similar resolution.

The Analysed column shows the number of residues for which the backbone conformation was analysed, and the total number of residues.

Mol	Chain	Analysed	Favoured	Allowed	Outliers	Percentiles	
1	A	268/276 (97%)	246 (92%)	21 (8%)	1 (0%)	34	37
1	D	269/276 (98%)	257 (96%)	12 (4%)	0	100	100
1	G	264/276 (96%)	249 (94%)	15 (6%)	0	100	100
1	J	246/276 (89%)	232 (94%)	11 (4%)	3 (1%)	13	9
2	B	98/99 (99%)	95 (97%)	3 (3%)	0	100	100
2	E	98/99 (99%)	94 (96%)	3 (3%)	1 (1%)	15	13
2	H	98/99 (99%)	95 (97%)	3 (3%)	0	100	100
2	K	98/99 (99%)	92 (94%)	6 (6%)	0	100	100
3	C	7/9 (78%)	6 (86%)	1 (14%)	0	100	100
3	F	7/9 (78%)	6 (86%)	1 (14%)	0	100	100
3	I	7/9 (78%)	5 (71%)	2 (29%)	0	100	100
3	L	7/9 (78%)	5 (71%)	2 (29%)	0	100	100
All	All	1467/1536 (96%)	1382 (94%)	80 (6%)	5 (0%)	41	46

All (5) Ramachandran outliers are listed below:

Mol	Chain	Res	Type
1	J	254	GLU
1	J	251	LEU
1	A	149	GLN
1	J	223	GLU
2	E	47	PRO

5.3.2 Protein sidechains [i](#)

In the following table, the Percentiles column shows the percent sidechain outliers of the chain as a percentile score with respect to all X-ray entries followed by that with respect to entries of similar resolution.

The Analysed column shows the number of residues for which the sidechain conformation was analysed, and the total number of residues.

Mol	Chain	Analysed	Rotameric	Outliers	Percentiles	
1	A	229/234 (98%)	223 (97%)	6 (3%)	46	55
1	D	230/234 (98%)	228 (99%)	2 (1%)	78	86
1	G	226/234 (97%)	223 (99%)	3 (1%)	69	79
1	J	215/234 (92%)	208 (97%)	7 (3%)	38	46
2	B	94/94 (100%)	94 (100%)	0	100	100
2	E	93/94 (99%)	92 (99%)	1 (1%)	73	82
2	H	94/94 (100%)	93 (99%)	1 (1%)	73	82
2	K	92/94 (98%)	87 (95%)	5 (5%)	22	22
3	C	8/8 (100%)	7 (88%)	1 (12%)	4	3
3	F	8/8 (100%)	8 (100%)	0	100	100
3	I	8/8 (100%)	8 (100%)	0	100	100
3	L	8/8 (100%)	8 (100%)	0	100	100
All	All	1305/1344 (97%)	1279 (98%)	26 (2%)	55	64

5 of 26 residues with a non-rotameric sidechain are listed below:

Mol	Chain	Res	Type
1	G	272	LEU
1	J	92	SER
2	K	70	PHE
1	G	273	ARG

Continued on next page...

Continued from previous page...

Mol	Chain	Res	Type
2	H	70	PHE

Some sidechains can be flipped to improve hydrogen bonding and reduce clashes. All (2) such sidechains are listed below:

Mol	Chain	Res	Type
1	D	70	GLN
1	D	87	GLN

5.3.3 RNA [i](#)

There are no RNA molecules in this entry.

5.4 Non-standard residues in protein, DNA, RNA chains [i](#)

There are no non-standard protein/DNA/RNA residues in this entry.

5.5 Carbohydrates [i](#)

There are no carbohydrates in this entry.

5.6 Ligand geometry [i](#)

2 ligands are modelled in this entry.

In the following table, the Counts columns list the number of bonds (or angles) for which Mogul statistics could be retrieved, the number of bonds (or angles) that are observed in the model and the number of bonds (or angles) that are defined in the Chemical Component Dictionary. The Link column lists molecule types, if any, to which the group is linked. The Z score for a bond length (or angle) is the number of standard deviations the observed value is removed from the expected value. A bond length (or angle) with $|Z| > 2$ is considered an outlier worth inspection. RMSZ is the root-mean-square of all Z scores of the bond lengths (or angles).

Mol	Type	Chain	Res	Link	Bond lengths			Bond angles		
					Counts	RMSZ	$\# Z > 2$	Counts	RMSZ	$\# Z > 2$
5	SO4	G	301	-	4,4,4	0.15	0	6,6,6	0.14	0
4	GOL	B	101	-	5,5,5	0.36	0	5,5,5	0.33	0

In the following table, the Chirals column lists the number of chiral outliers, the number of chiral centers analysed, the number of these observed in the model and the number defined in the Chemical Component Dictionary. Similar counts are reported in the Torsion and Rings columns.

'-' means no outliers of that kind were identified.

Mol	Type	Chain	Res	Link	Chirals	Torsions	Rings
4	GOL	B	101	-	-	2/4/4/4	-

There are no bond length outliers.

There are no bond angle outliers.

There are no chirality outliers.

All (2) torsion outliers are listed below:

Mol	Chain	Res	Type	Atoms
4	B	101	GOL	O1-C1-C2-C3
4	B	101	GOL	O1-C1-C2-O2

There are no ring outliers.

1 monomer is involved in 2 short contacts:

Mol	Chain	Res	Type	Clashes	Symm-Clashes
4	B	101	GOL	2	0

5.7 Other polymers [i](#)

There are no such residues in this entry.

5.8 Polymer linkage issues [i](#)

There are no chain breaks in this entry.

6 Fit of model and data [i](#)

6.1 Protein, DNA and RNA chains [i](#)

In the following table, the column labelled ‘#RSRZ> 2’ contains the number (and percentage) of RSRZ outliers, followed by percent RSRZ outliers for the chain as percentile scores relative to all X-ray entries and entries of similar resolution. The OWAB column contains the minimum, median, 95th percentile and maximum values of the occupancy-weighted average B-factor per residue. The column labelled ‘Q< 0.9’ lists the number of (and percentage) of residues with an average occupancy less than 0.9.

Mol	Chain	Analysed	<RSRZ>	#RSRZ>2	OWAB(Å ²)	Q<0.9
1	A	272/276 (98%)	0.68	24 (8%) 10 11	23, 48, 89, 106	0
1	D	272/276 (98%)	0.52	26 (9%) 8 8	23, 43, 96, 110	0
1	G	269/276 (97%)	0.52	18 (6%) 17 19	28, 51, 94, 111	0
1	J	258/276 (93%)	0.93	41 (15%) 1 1	24, 62, 115, 145	0
2	B	99/99 (100%)	0.14	1 (1%) 82 84	25, 33, 49, 58	0
2	E	99/99 (100%)	0.26	1 (1%) 82 84	26, 40, 61, 74	0
2	H	99/99 (100%)	0.16	1 (1%) 82 84	30, 41, 56, 73	0
2	K	99/99 (100%)	0.75	7 (7%) 16 17	32, 64, 85, 95	0
3	C	9/9 (100%)	0.37	0 100 100	33, 39, 47, 57	0
3	F	9/9 (100%)	0.02	0 100 100	23, 29, 33, 40	0
3	I	9/9 (100%)	0.17	0 100 100	32, 35, 48, 53	0
3	L	9/9 (100%)	0.29	0 100 100	33, 37, 50, 58	0
All	All	1503/1536 (97%)	0.56	119 (7%) 12 14	23, 47, 93, 145	0

The worst 5 of 119 RSRZ outliers are listed below:

Mol	Chain	Res	Type	RSRZ
1	J	219	LEU	7.3
1	J	224	LEU	6.4
1	J	201	LEU	6.1
1	J	217	TRP	6.0
1	J	256	ASN	5.5

6.2 Non-standard residues in protein, DNA, RNA chains [i](#)

There are no non-standard protein/DNA/RNA residues in this entry.

6.3 Carbohydrates [i](#)

There are no carbohydrates in this entry.

6.4 Ligands [i](#)

In the following table, the Atoms column lists the number of modelled atoms in the group and the number defined in the chemical component dictionary. The B-factors column lists the minimum, median, 95th percentile and maximum values of B factors of atoms in the group. The column labelled 'Q< 0.9' lists the number of atoms with occupancy less than 0.9.

Mol	Type	Chain	Res	Atoms	RSCC	RSR	B-factors(\AA^2)	Q<0.9
4	GOL	B	101	6/6	0.91	0.12	66,69,71,73	0
5	SO4	G	301	5/5	0.93	0.18	75,83,91,92	0

6.5 Other polymers [i](#)

There are no such residues in this entry.