



wwPDB X-ray Structure Validation Summary Report ⓘ

Jan 21, 2024 – 01:05 am GMT

PDB ID : 5DGF
Title : Complex of yeast 80S ribosome with hypusine-containing/non-modified eIF5A and/or a peptidyl-tRNA analog
Authors : Melnikov, S.; Mailliot, J.; Shin, B.-S.; Rigger, L.; Yusupova, G.; Micura, R.; Dever, T.E.; Yusupov, M.
Deposited on : 2015-08-27
Resolution : 3.30 Å(reported)

This is a wwPDB X-ray Structure Validation Summary Report for a publicly released PDB entry.

We welcome your comments at validation@mail.wwpdb.org

A user guide is available at

<https://www.wwpdb.org/validation/2017/XrayValidationReportHelp>

with specific help available everywhere you see the ⓘ symbol.

The types of validation reports are described at

<http://www.wwpdb.org/validation/2017/FAQs#types>.

The following versions of software and data (see [references ⓘ](#)) were used in the production of this report:

MolProbity : 4.02b-467
Mogul : 1.8.4, CSD as541be (2020)
Xtrriage (Phenix) : 1.13
EDS : 2.36
buster-report : 1.1.7 (2018)
Percentile statistics : 20191225.v01 (using entries in the PDB archive December 25th 2019)
Refmac : 5.8.0158
CCP4 : 7.0.044 (Gargrove)
Ideal geometry (proteins) : Engh & Huber (2001)
Ideal geometry (DNA, RNA) : Parkinson et al. (1996)
Validation Pipeline (wwPDB-VP) : 2.36

1 Overall quality at a glance

The following experimental techniques were used to determine the structure:

X-RAY DIFFRACTION

The reported resolution of this entry is 3.30 Å.

Percentile scores (ranging between 0-100) for global validation metrics of the entry are shown in the following graphic. The table shows the number of entries on which the scores are based.

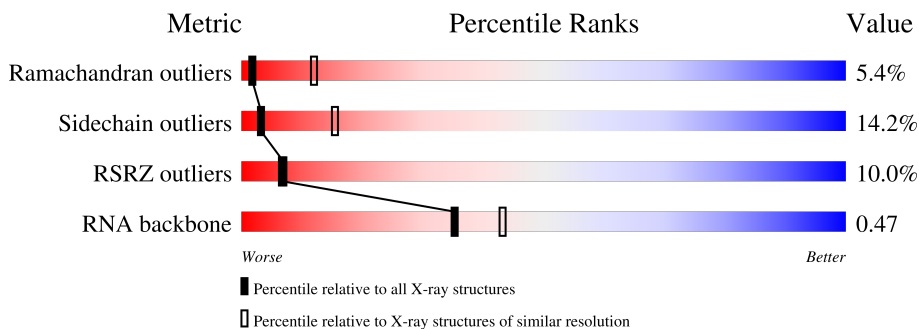

Metric	Whole archive (#Entries)	Similar resolution (#Entries, resolution range(Å))
Ramachandran outliers	138981	1183 (3.34-3.26)
Sidechain outliers	138945	1182 (3.34-3.26)
RSRZ outliers	127900	1115 (3.34-3.26)
RNA backbone	3102	1117 (3.70-2.90)

The table below summarises the geometric issues observed across the polymeric chains and their fit to the electron density. The red, orange, yellow and green segments of the lower bar indicate the fraction of residues that contain outliers for ≥ 3 , 2, 1 and 0 types of geometric quality criteria respectively. A grey segment represents the fraction of residues that are not modelled. The numeric value for each fraction is indicated below the corresponding segment, with a dot representing fractions $\leq 5\%$. The upper red bar (where present) indicates the fraction of residues that have poor fit to the electron density. The numeric value is given above the bar.

Mol	Chain	Length	Quality of chain
1	2	1800	
1	6	1800	
2	S0	251	
2	s0	251	
3	S1	254	
3	s1	254	

Continued on next page...

Continued from previous page...

Mol	Chain	Length	Quality of chain
4	S2	253	
4	s2	253	
5	S3	239	
5	s3	239	
6	S4	260	
6	s4	260	
7	S5	224	
7	s5	224	
8	S6	236	
8	s6	236	
9	S7	189	
9	s7	189	
10	S8	200	
10	s8	200	
11	S9	196	
11	s9	196	
12	C0	96	
12	c0	96	
13	C1	155	
13	c1	155	
14	C2	142	
14	c2	142	
15	C3	150	
15	c3	150	
16	C4	136	

Continued on next page...

Continued from previous page...

Mol	Chain	Length	Quality of chain
16	c4	136	32% 71% 21% 6%
17	C5	141	15% 74% 10% 12%
17	c5	141	11% 80% 13% ..
18	C6	142	32% 85% 13% ..
18	c6	142	18% 82% 18%
19	C7	136	24% 71% 15% 12%
19	c7	136	7% 74% 11% 14%
20	C8	145	17% 78% 21% .
20	c8	145	16% 83% 15% .
21	C9	143	26% 84% 15% .
21	c9	143	36% 85% 15% .
22	D0	120	17% 76% 13% 11%
22	d0	120	48% 78% 14% 8%
23	D1	87	18% 80% 20%
23	d1	87	10% 85% 15%
24	D2	129	9% 86% 12% .
24	d2	129	8% 84% 15% .
25	D3	144	12% 83% 17% .
25	d3	144	5% 90% 10%
26	D4	134	25% 87% 13% .
26	d4	134	7% 84% 15% .
27	D5	107	22% 47% 18% 35%
27	d5	107	18% 55% 8% 36%
28	D6	97	45% 72% 27% .
28	d6	97	27% 79% 19% .















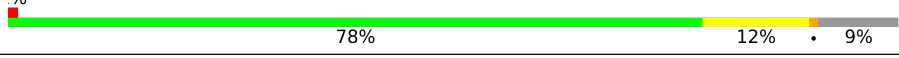

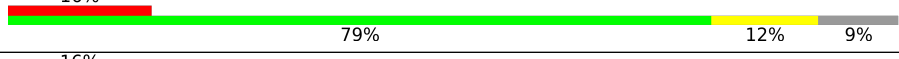
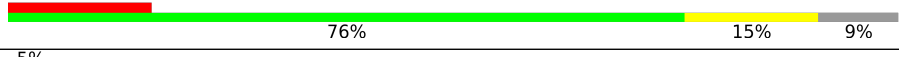

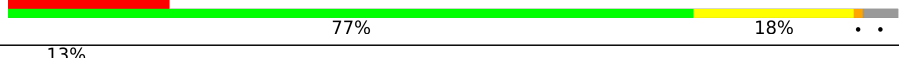

Continued on next page...

Continued from previous page...

Mol	Chain	Length	Quality of chain
29	D7	81	21% 86% 14%
29	d7	81	16% 85% 15%
30	D8	66	20% 80% 15% 5%
30	d8	66	15% 77% 17% 5%
31	D9	55	22% 78% 15% • •
31	d9	55	47% 75% 22% •
32	E0	62	34% 87% 10% •
32	e0	62	18% 66% 32% •
33	E1	76	12% 63% 24% 7% 7%
33	e1	76	26% 67% 29% •
34	SR	318	32% 85% 14% •
34	sR	318	33% 91% 9%
35	SM	273	8% 48% 10% • 42%
35	sM	273	8% 33% • • 62%
36	1	3396	% 71% 20% • 7%
36	5	3396	% 72% 21% • 7%
37	3	121	91% 9%
37	7	121	88% 11% •
38	4	158	% 79% 20% •
38	8	158	% 78% 21% •
39	L2	253	4% 85% 15%
39	l2	253	4% 82% 17% •
40	L3	386	5% 82% 18%
40	l3	386	2% 82% 16% •
41	L4	361	84% 16%

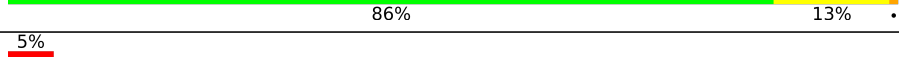
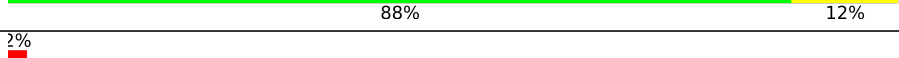
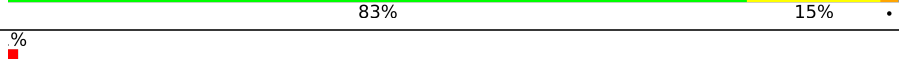
Continued on next page...

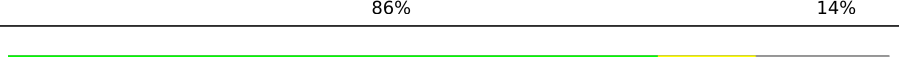
Continued from previous page...

Mol	Chain	Length	Quality of chain
41	l4	361	 % 84% 15%
42	L5	296	 23% 83% 16%
42	l5	296	 7% 83% 15%
43	L6	175	 6% 78% 11% 11%
43	l6	175	 3% 77% 13% 10%
44	L7	243	 % 78% 12% 9%
44	l7	243	 80% 11% 8%
45	L8	255	 16% 79% 12% 9%
45	l8	255	 16% 76% 15% 9%
46	L9	191	 5% 74% 26%
46	l9	191	 % 83% 16%
47	M0	220	 18% 77% 18%
47	m0	220	 13% 78% 18%
48	M1	173	 14% 75% 22%
48	m1	173	 3% 78% 19%
49	M3	198	 4% 83% 15%
49	m3	198	 15% 78% 19%
50	M4	137	 % 85% 13%
50	m4	137	 % 88% 12%
51	M5	203	 % 86% 13%
51	m5	203	 5% 88% 12%
52	M6	198	 2% 83% 15%
52	m6	198	 % 87% 12%
53	M7	183	 13% 86% 14%
53	m7	183	 73% 11% 15%

Continued on next page...

Continued from previous page...

Mol	Chain	Length	Quality of chain
54	M8	185	2% 86% 14%
54	m8	185	83% 16%
55	M9	188	10% 88% 12%
55	m9	188	6% 88% 12%
56	N0	172	2% 84% 16%
56	n0	172	% 85% 15%
57	N1	159	3% 80% 18%
57	n1	159	7% 84% 16%
58	N2	120	21% 73% 9% 17%
58	n2	120	18% 69% 12% 18%
59	N3	136	8% 87% 12%
59	n3	136	2% 85% 14%
60	N4	155	19% 54% 9% 37%
60	n4	155	12% 79% 8% 13%
61	N5	141	10% 69% 16% 14%
61	n5	141	% 70% 13% 15%
62	N6	126	15% 84% 14%
62	n6	126	3% 84% 15%
63	N7	135	36% 84% 13%
63	n7	135	32% 84% 14%
64	N8	148	% 82% 18%
64	n8	148	2% 82% 17%
65	N9	58	7% 84% 16%
65	n9	58	9% 83% 14%
66	O0	104	9% 81% 12% 7%

Continued on next page...

Continued from previous page...

Mol	Chain	Length	Quality of chain
66	o0	104	2% 83% 13% .
67	O1	112	12% 83% 13% ..
67	o1	112	4% 77% 19% ..
68	O2	129	2% 84% 15% .
68	o2	129	5% 80% 17% ..
69	O3	106	% 85% 14% .
69	o3	106	85% 15%
70	O4	120	6% 82% 12% 7%
70	o4	120	7% 82% 11% 7%
71	O5	119	5% 84% 16%
71	o5	119	7% 87% 13%
72	O6	99	5% 80% 15% 5%
72	o6	99	4% 72% 25% .
73	O7	87	% 86% 13% .
73	o7	87	2% 91% 8% .
74	O8	77	10% 82% 18%
74	o8	77	32% 81% 19%
75	O9	50	2% 82% 16% .
75	o9	50	2% 94% 6%
76	Q0	52	13% 81% 17% .
76	q0	52	2% 83% 17%
77	Q1	25	24% 88% 12%
77	q1	25	8% 72% 28%
78	Q2	105	2% 80% 19% .
78	q2	105	% 77% 22% .

Continued on next page...

Continued from previous page...

Mol	Chain	Length	Quality of chain
79	Q3	91	<p>2% 84% 14%</p>
79	q3	91	<p>3% 88% 12%</p>
80	m2	165	<p>91% 9%</p>
81	p0	311	<p>10% 41% 5% 54%</p>
82	p1	47	<p>100%</p>
82	p2	47	<p>98%</p>
83	f	157	<p>59% 73% 19% 6%</p>
84	B	5	<p>40% 60%</p>
84	C	5	<p>40% 60%</p>

2 Entry composition [i](#)

There are 89 unique types of molecules in this entry. The entry contains 404292 atoms, of which 0 are hydrogens and 0 are deuteriums.

In the tables below, the ZeroOcc column contains the number of atoms modelled with zero occupancy, the AltConf column contains the number of residues with at least one atom in alternate conformation and the Trace column contains the number of residues modelled with at most 2 atoms.

- Molecule 1 is a RNA chain called 18S ribosomal RNA.

Mol	Chain	Residues	Atoms					ZeroOcc	AltConf	Trace
			Total	C	N	O	P			
1	2	1781	Total	C	N	O	P	0	1	0
			37970	16975	6720	12493	1782			
1	6	1795	Total	C	N	O	P	0	1	0
			38260	17105	6763	12596	1796			

- Molecule 2 is a protein called 40S ribosomal protein S0-A.

Mol	Chain	Residues	Atoms					ZeroOcc	AltConf	Trace
			Total	C	N	O	S			
2	S0	206	Total	C	N	O	S	0	0	0
			1577	1014	278	283	2			
2	s0	206	Total	C	N	O	S	0	0	0
			1583	1017	281	283	2			

- Molecule 3 is a protein called 40S ribosomal protein S1-A.

Mol	Chain	Residues	Atoms					ZeroOcc	AltConf	Trace
			Total	C	N	O	S			
3	S1	214	Total	C	N	O	S	0	0	0
			1709	1084	310	311	4			
3	s1	216	Total	C	N	O	S	0	0	0
			1722	1091	312	315	4			

- Molecule 4 is a protein called 40S ribosomal protein S2.

Mol	Chain	Residues	Atoms					ZeroOcc	AltConf	Trace
			Total	C	N	O	S			
4	S2	217	Total	C	N	O	S	0	0	0
			1635	1047	289	297	2			
4	s2	217	Total	C	N	O	S	0	0	0
			1635	1047	289	297	2			

- Molecule 5 is a protein called 40S ribosomal protein S3.

Mol	Chain	Residues	Atoms					ZeroOcc	AltConf	Trace
			Total	C	N	O	S			
5	S3	223	Total 1734	C 1101	N 313	O 314	S 6	0	0	0
5	s3	223	Total 1734	C 1101	N 313	O 314	S 6	0	0	0

- Molecule 6 is a protein called 40S ribosomal protein S4-A.

Mol	Chain	Residues	Atoms					ZeroOcc	AltConf	Trace
			Total	C	N	O	S			
6	S4	260	Total 2068	C 1316	N 389	O 360	S 3	0	0	0
6	s4	260	Total 2068	C 1316	N 389	O 360	S 3	0	0	0

- Molecule 7 is a protein called 40S ribosomal protein S5.

Mol	Chain	Residues	Atoms					ZeroOcc	AltConf	Trace
			Total	C	N	O	S			
7	S5	206	Total 1609	C 1007	N 300	O 299	S 3	0	0	0
7	s5	206	Total 1609	C 1007	N 300	O 299	S 3	0	0	0

- Molecule 8 is a protein called 40S ribosomal protein S6-A.

Mol	Chain	Residues	Atoms					ZeroOcc	AltConf	Trace
			Total	C	N	O	S			
8	S6	226	Total 1799	C 1129	N 346	O 321	S 3	0	0	0
8	s6	218	Total 1755	C 1102	N 337	O 313	S 3	0	0	0

- Molecule 9 is a protein called 40S ribosomal protein S7-A.

Mol	Chain	Residues	Atoms					ZeroOcc	AltConf	Trace
			Total	C	N	O	S			
9	S7	184	Total 1481	C 951	N 265	O 265		0	0	0
9	s7	186	Total 1491	C 957	N 267	O 267		0	0	0

- Molecule 10 is a protein called 40S ribosomal protein S8-A.

Mol	Chain	Residues	Atoms					ZeroOcc	AltConf	Trace
			Total	C	N	O	S			
10	S8	188	Total 1489	C 925	N 298	O 264	S 2	0	0	0

Continued on next page...

Continued from previous page...

Mol	Chain	Residues	Atoms					ZeroOcc	AltConf	Trace
			Total	C	N	O	S			
10	s8	188	1489	925	298	264	2	0	0	0

- Molecule 11 is a protein called 40S ribosomal protein S9-A.

Mol	Chain	Residues	Atoms					ZeroOcc	AltConf	Trace
			Total	C	N	O	S			
11	S9	185	1494	943	289	261	1	0	0	0
11	s9	185	1494	943	289	261	1	0	0	0

- Molecule 12 is a protein called 40S ribosomal protein S10-A.

Mol	Chain	Residues	Atoms					ZeroOcc	AltConf	Trace
			Total	C	N	O	S			
12	C0	96	773	500	126	145	2	0	0	0
12	c0	96	762	491	125	144	2	0	0	0

- Molecule 13 is a protein called 40S ribosomal protein S11-A.

Mol	Chain	Residues	Atoms					ZeroOcc	AltConf	Trace
			Total	C	N	O	S			
13	C1	155	1214	775	230	206	3	0	0	0
13	c1	146	1168	747	221	197	3	0	0	0

- Molecule 14 is a protein called 40S ribosomal protein S12.

Mol	Chain	Residues	Atoms					ZeroOcc	AltConf	Trace
			Total	C	N	O	S			
14	C2	124	892	562	156	172	2	0	0	0
14	c2	124	892	562	156	172	2	0	0	0

- Molecule 15 is a protein called 40S ribosomal protein S13.

Mol	Chain	Residues	Atoms					ZeroOcc	AltConf	Trace
			Total	C	N	O	S			
15	C3	150	1192	759	224	207	2	0	0	0
15	c3	150	1192	759	224	207	2	0	0	0

- Molecule 16 is a protein called 40S ribosomal protein S14-A.

Mol	Chain	Residues	Atoms					ZeroOcc	AltConf	Trace
16	C4	127	Total	C	N	O	S	0	0	0
			891	545	182	163	1			
16	c4	128	Total	C	N	O	S	0	0	0
			949	582	188	176	3			

- Molecule 17 is a protein called 40S ribosomal protein S15 (uS19).

Mol	Chain	Residues	Atoms					ZeroOcc	AltConf	Trace
17	C5	124	Total	C	N	O	S	0	0	0
			977	622	182	166	7			
17	c5	135	Total	C	N	O	S	0	0	0
			1039	658	196	178	7			

- Molecule 18 is a protein called 40S ribosomal protein S16-A.

Mol	Chain	Residues	Atoms				ZeroOcc	AltConf	Trace
18	C6	141	Total	C	N	O	0	0	0
			1105	708	203	194			
18	c6	142	Total	C	N	O	0	0	0
			1111	711	204	196			

- Molecule 19 is a protein called 40S ribosomal protein S17-A.

Mol	Chain	Residues	Atoms					ZeroOcc	AltConf	Trace
19	C7	120	Total	C	N	O	S	0	0	0
			926	577	177	170	2			
19	c7	117	Total	C	N	O	S	0	0	0
			906	563	174	167	2			

- Molecule 20 is a protein called 40S ribosomal protein S18-A.

Mol	Chain	Residues	Atoms					ZeroOcc	AltConf	Trace
20	C8	145	Total	C	N	O	S	0	0	0
			1192	743	237	210	2			
20	c8	145	Total	C	N	O	S	0	0	0
			1192	743	237	210	2			

- Molecule 21 is a protein called 40S ribosomal protein S19-A.

Mol	Chain	Residues	Atoms					ZeroOcc	AltConf	Trace
21	C9	143	Total	C	N	O	S	0	0	0
			1112	694	208	208	2			
21	c9	143	Total	C	N	O	S	0	0	0
			1112	694	208	208	2			

- Molecule 22 is a protein called 40S ribosomal protein S20.

Mol	Chain	Residues	Atoms					ZeroOcc	AltConf	Trace
22	D0	107	Total	C	N	O	S	0	0	0
			855	539	156	159	1			
22	d0	110	Total	C	N	O	S	0	0	0
			882	554	161	166	1			

- Molecule 23 is a protein called 40S ribosomal protein S21-A.

Mol	Chain	Residues	Atoms					ZeroOcc	AltConf	Trace
23	D1	87	Total	C	N	O	S	0	0	0
			684	420	125	137	2			
23	d1	87	Total	C	N	O	S	0	0	0
			684	420	125	137	2			

- Molecule 24 is a protein called 40S ribosomal protein S22-A.

Mol	Chain	Residues	Atoms					ZeroOcc	AltConf	Trace
24	D2	129	Total	C	N	O	S	0	0	0
			1021	650	188	180	3			
24	d2	129	Total	C	N	O	S	0	0	0
			1021	650	188	180	3			

- Molecule 25 is a protein called 40S ribosomal protein S23-A.

Mol	Chain	Residues	Atoms					ZeroOcc	AltConf	Trace
25	D3	144	Total	C	N	O	S	0	0	0
			1121	708	220	191	2			
25	d3	144	Total	C	N	O	S	0	0	0
			1121	708	220	191	2			

- Molecule 26 is a protein called 40S ribosomal protein S24-A.

Mol	Chain	Residues	Atoms				ZeroOcc	AltConf	Trace
26	D4	134	Total	C	N	O	0	0	0
			1073	676	208	189			

Continued on next page...

Continued from previous page...

Mol	Chain	Residues	Atoms				ZeroOcc	AltConf	Trace
26	d4	134	Total	C	N	O	0	0	0
			1073	676	208	189			

- Molecule 27 is a protein called 40S ribosomal protein S25-A.

Mol	Chain	Residues	Atoms				ZeroOcc	AltConf	Trace
27	D5	70	Total	C	N	O	0	0	0
			563	360	104	99			
27	d5	69	Total	C	N	O	0	0	0
			558	357	103	98			

- Molecule 28 is a protein called 40S ribosomal protein S26-B.

Mol	Chain	Residues	Atoms					ZeroOcc	AltConf	Trace
28	D6	97	Total	C	N	O	S	0	0	0
			769	475	160	129	5			
28	d6	97	Total	C	N	O	S	0	0	0
			769	475	160	129	5			

- Molecule 29 is a protein called 40S ribosomal protein S27-A.

Mol	Chain	Residues	Atoms					ZeroOcc	AltConf	Trace
29	D7	81	Total	C	N	O	S	0	0	0
			610	382	110	113	5			
29	d7	81	Total	C	N	O	S	0	0	0
			610	382	110	113	5			

- Molecule 30 is a protein called 40S ribosomal protein S28-A.

Mol	Chain	Residues	Atoms					ZeroOcc	AltConf	Trace
30	D8	63	Total	C	N	O	S	0	0	0
			497	306	99	91	1			
30	d8	63	Total	C	N	O	S	0	0	0
			497	306	99	91	1			

- Molecule 31 is a protein called 40S ribosomal protein S29-A.

Mol	Chain	Residues	Atoms					ZeroOcc	AltConf	Trace
31	D9	53	Total	C	N	O	S	0	0	0
			442	274	92	72	4			
31	d9	53	Total	C	N	O	S	0	0	0
			442	274	92	72	4			

- Molecule 32 is a protein called 40S ribosomal protein S30-A.

Mol	Chain	Residues	Atoms					ZeroOcc	AltConf	Trace
			Total	C	N	O	S			
32	E0	60	Total 475	C 299	N 98	O 77	S 1	0	0	0
32	e0	62	Total 491	C 309	N 101	O 80	S 1	0	0	0

- Molecule 33 is a protein called Ubiquitin-40S ribosomal protein S31.

Mol	Chain	Residues	Atoms					ZeroOcc	AltConf	Trace
			Total	C	N	O	S			
33	E1	71	Total 566	C 362	N 106	O 94	S 4	0	0	0
33	e1	76	Total 608	C 388	N 117	O 99	S 4	0	0	0

- Molecule 34 is a protein called Guanine nucleotide-binding protein subunit beta-like protein.

Mol	Chain	Residues	Atoms					ZeroOcc	AltConf	Trace
			Total	C	N	O	S			
34	SR	318	Total 2437	C 1541	N 418	O 470	S 8	0	0	0
34	sR	318	Total 2442	C 1544	N 418	O 472	S 8	0	0	0

- Molecule 35 is a protein called Suppressor protein STM1.

Mol	Chain	Residues	Atoms				ZeroOcc	AltConf	Trace
			Total	C	N	O			
35	SM	159	Total 1105	C 653	N 221	O 231	0	0	0
35	sM	104	Total 680	C 403	N 140	O 137	0	0	0

- Molecule 36 is a RNA chain called 25S ribosomal RNA.

Mol	Chain	Residues	Atoms					ZeroOcc	AltConf	Trace
			Total	C	N	O	P			
36	1	3149	Total 67355	C 30086	N 12142	O 21978	P 3149	0	0	0
36	5	3169	Total 67780	C 30276	N 12216	O 22120	P 3168	0	0	0

- Molecule 37 is a RNA chain called 5S ribosomal RNA.

Mol	Chain	Residues	Atoms					ZeroOcc	AltConf	Trace
37	3	121	Total	C	N	O	P	0	0	0
			2579	1152	461	845	121			
37	7	121	Total	C	N	O	P	0	0	0
			2579	1152	461	845	121			

- Molecule 38 is a RNA chain called 5.8S ribosomal RNA.

Mol	Chain	Residues	Atoms					ZeroOcc	AltConf	Trace
38	4	158	Total	C	N	O	P	0	0	0
			3353	1500	586	1109	158			
38	8	158	Total	C	N	O	P	0	0	0
			3353	1500	586	1109	158			

- Molecule 39 is a protein called 60S ribosomal protein L2-A.

Mol	Chain	Residues	Atoms					ZeroOcc	AltConf	Trace
39	L2	252	Total	C	N	O	S	0	0	0
			1914	1191	388	334	1			
39	l2	252	Total	C	N	O	S	0	0	0
			1912	1190	388	333	1			

- Molecule 40 is a protein called 60S ribosomal protein L3.

Mol	Chain	Residues	Atoms					ZeroOcc	AltConf	Trace
40	L3	386	Total	C	N	O	S	0	0	0
			3075	1950	584	533	8			
40	l3	386	Total	C	N	O	S	0	0	0
			3075	1950	584	533	8			

- Molecule 41 is a protein called 60S ribosomal protein L4-A.

Mol	Chain	Residues	Atoms					ZeroOcc	AltConf	Trace
41	L4	361	Total	C	N	O	S	0	0	0
			2748	1729	522	494	3			
41	l4	361	Total	C	N	O	S	0	0	0
			2748	1729	522	494	3			

- Molecule 42 is a protein called 60S ribosomal protein L5.

Mol	Chain	Residues	Atoms					ZeroOcc	AltConf	Trace
42	L5	296	Total	C	N	O	S	0	0	0
			2375	1501	414	458	2			

Continued on next page...

Continued from previous page...

Mol	Chain	Residues	Atoms					ZeroOcc	AltConf	Trace
			Total	C	N	O	S			
42	15	294	Total	C	N	O	S	0	0	0
			2359	1489	412	456	2			

- Molecule 43 is a protein called 60S ribosomal protein L6-A.

Mol	Chain	Residues	Atoms					ZeroOcc	AltConf	Trace
			Total	C	N	O	S			
43	L6	156	Total	C	N	O	S	0	0	0
			1239	800	222	216	1			
43	16	157	Total	C	N	O	S	0	0	0
			1248	806	224	217	1			

- Molecule 44 is a protein called 60S ribosomal protein L7-A.

Mol	Chain	Residues	Atoms					ZeroOcc	AltConf	Trace
			Total	C	N	O	S			
44	L7	222	Total	C	N	O	S	0	0	0
			1784	1151	324	308	1			
44	17	223	Total	C	N	O	S	0	0	0
			1791	1155	325	310	1			

- Molecule 45 is a protein called 60S ribosomal protein L8-A.

Mol	Chain	Residues	Atoms					ZeroOcc	AltConf	Trace
			Total	C	N	O	S			
45	L8	233	Total	C	N	O	S	0	0	0
			1804	1151	323	327	3			
45	18	231	Total	C	N	O	S	0	0	0
			1764	1131	316	314	3			

There are 2 discrepancies between the modelled and reference sequences:

Chain	Residue	Modelled	Actual	Comment	Reference
L8	119	ALA	GLY	conflict	UNP P17076
18	119	ALA	GLY	conflict	UNP P17076

- Molecule 46 is a protein called 60S ribosomal protein L9-A.

Mol	Chain	Residues	Atoms					ZeroOcc	AltConf	Trace
			Total	C	N	O	S			
46	L9	191	Total	C	N	O	S	0	0	0
			1518	963	274	277	4			
46	19	191	Total	C	N	O	S	0	0	0
			1518	963	274	277	4			

- Molecule 47 is a protein called 60S ribosomal protein L10.

Mol	Chain	Residues	Atoms					ZeroOcc	AltConf	Trace
47	M0	211	Total	C	N	O	S	0	0	0
			1705	1083	322	294	6			
47	m0	213	Total	C	N	O	S	0	0	0
			1722	1094	325	297	6			

- Molecule 48 is a protein called 60S ribosomal protein L11-B.

Mol	Chain	Residues	Atoms					ZeroOcc	AltConf	Trace
48	M1	169	Total	C	N	O	S	0	0	0
			1353	847	253	249	4			
48	m1	169	Total	C	N	O	S	0	0	0
			1353	847	253	249	4			

- Molecule 49 is a protein called 60S ribosomal protein L13-A.

Mol	Chain	Residues	Atoms				ZeroOcc	AltConf	Trace
49	M3	193	Total	C	N	O	0	0	0
			1543	962	315	266			
49	m3	194	Total	C	N	O	0	0	0
			1548	965	316	267			

- Molecule 50 is a protein called 60S ribosomal protein L14-A.

Mol	Chain	Residues	Atoms					ZeroOcc	AltConf	Trace
50	M4	136	Total	C	N	O	S	0	0	0
			1053	675	199	177	2			
50	m4	137	Total	C	N	O	S	0	0	0
			1059	678	200	179	2			

- Molecule 51 is a protein called 60S ribosomal protein L15-A.

Mol	Chain	Residues	Atoms					ZeroOcc	AltConf	Trace
51	M5	203	Total	C	N	O	S	0	0	0
			1720	1077	361	281	1			
51	m5	203	Total	C	N	O	S	0	0	0
			1720	1077	361	281	1			

- Molecule 52 is a protein called 60S ribosomal protein L16-A.

Mol	Chain	Residues	Atoms					ZeroOcc	AltConf	Trace
52	M6	197	Total	C	N	O	S	0	0	0
			1555	1003	289	262	1			

Continued on next page...

Continued from previous page...

Mol	Chain	Residues	Atoms					ZeroOcc	AltConf	Trace
			Total	C	N	O	S			
52	m6	197	Total	C	N	O	S	0	0	0
			1555	1003	289	262	1			

- Molecule 53 is a protein called 60S ribosomal protein L17-A.

Mol	Chain	Residues	Atoms				ZeroOcc	AltConf	Trace
			Total	C	N	O			
53	M7	183	Total	C	N	O	0	0	0
			1420	882	281	257			
53	m7	155	Total	C	N	O	0	0	0
			1227	764	238	225			

- Molecule 54 is a protein called 60S ribosomal protein L18-A.

Mol	Chain	Residues	Atoms					ZeroOcc	AltConf	Trace
			Total	C	N	O	S			
54	M8	185	Total	C	N	O	S	0	0	0
			1441	908	290	241	2			
54	m8	185	Total	C	N	O	S	0	0	0
			1441	908	290	241	2			

- Molecule 55 is a protein called 60S ribosomal protein L19-A.

Mol	Chain	Residues	Atoms				ZeroOcc	AltConf	Trace
			Total	C	N	O			
55	M9	188	Total	C	N	O	0	0	0
			1521	935	326	260			
55	m9	188	Total	C	N	O	0	0	0
			1521	935	326	260			

- Molecule 56 is a protein called 60S ribosomal protein L20-A.

Mol	Chain	Residues	Atoms					ZeroOcc	AltConf	Trace
			Total	C	N	O	S			
56	N0	172	Total	C	N	O	S	0	0	0
			1445	930	267	244	4			
56	n0	172	Total	C	N	O	S	0	0	0
			1445	930	267	244	4			

- Molecule 57 is a protein called 60S ribosomal protein L21-A.

Mol	Chain	Residues	Atoms				ZeroOcc	AltConf	Trace	
			Total	C	N	O				
57	N1	159	Total	C	N	O	S	0	0	0
			1276	805	246	221	4			
57	n1	159	Total	C	N	O	S	0	0	0
			1276	805	246	221	4			

- Molecule 58 is a protein called 60S ribosomal protein L22-A.

Mol	Chain	Residues	Atoms				ZeroOcc	AltConf	Trace
			Total	C	N	O			
58	N2	100	796	516	131	149	0	0	0
58	n2	98	778	505	127	146	0	0	0

- Molecule 59 is a protein called 60S ribosomal protein L23-A.

Mol	Chain	Residues	Atoms					ZeroOcc	AltConf	Trace
			Total	C	N	O	S			
59	N3	136	1003	628	189	179	7	0	0	0
59	n3	136	1003	628	189	179	7	0	0	0

- Molecule 60 is a protein called 60S ribosomal protein L24-A.

Mol	Chain	Residues	Atoms					ZeroOcc	AltConf	Trace
			Total	C	N	O	S			
60	N4	98	699	443	137	118	1	0	0	0
60	n4	135	1038	651	206	180	1	0	0	0

- Molecule 61 is a protein called 60S ribosomal protein L25.

Mol	Chain	Residues	Atoms					ZeroOcc	AltConf	Trace
			Total	C	N	O	S			
61	N5	121	964	620	169	173	2	0	0	0
61	n5	120	959	617	168	172	2	0	0	0

- Molecule 62 is a protein called 60S ribosomal protein L26-A.

Mol	Chain	Residues	Atoms				ZeroOcc	AltConf	Trace
			Total	C	N	O			
62	N6	126	993	625	192	176	0	0	0
62	n6	126	993	625	192	176	0	0	0

- Molecule 63 is a protein called 60S ribosomal protein L27-A.

Mol	Chain	Residues	Atoms				ZeroOcc	AltConf	Trace
63	N7	135	Total	C	N	O	0	0	0
			1092	710	202	180			
63	n7	135	Total	C	N	O	0	0	0
			1092	710	202	180			

- Molecule 64 is a protein called 60S ribosomal protein L28.

Mol	Chain	Residues	Atoms					ZeroOcc	AltConf	Trace
64	N8	148	Total	C	N	O	S	0	0	0
			1173	749	231	190	3			
64	n8	148	Total	C	N	O	S	0	0	0
			1173	749	231	190	3			

- Molecule 65 is a protein called 60S ribosomal protein L29.

Mol	Chain	Residues	Atoms				ZeroOcc	AltConf	Trace
65	N9	58	Total	C	N	O	0	0	0
			462	289	100	73			
65	n9	58	Total	C	N	O	0	0	0
			462	289	100	73			

- Molecule 66 is a protein called 60S ribosomal protein L30.

Mol	Chain	Residues	Atoms					ZeroOcc	AltConf	Trace
66	O0	97	Total	C	N	O	S	0	0	0
			743	479	124	139	1			
66	o0	100	Total	C	N	O	S	0	0	0
			767	492	128	146	1			

- Molecule 67 is a protein called 60S ribosomal protein L31-A.

Mol	Chain	Residues	Atoms					ZeroOcc	AltConf	Trace
67	O1	109	Total	C	N	O	S	0	0	0
			876	556	167	152	1			
67	o1	109	Total	C	N	O	S	0	0	0
			883	559	167	156	1			

- Molecule 68 is a protein called 60S ribosomal protein L32.

Mol	Chain	Residues	Atoms					ZeroOcc	AltConf	Trace
68	O2	127	Total	C	N	O	S	0	0	0
			1020	647	205	167	1			

Continued on next page...

Continued from previous page...

Mol	Chain	Residues	Atoms					ZeroOcc	AltConf	Trace
68	o2	127	Total	C	N	O	S	0	0	0
			1020	647	205	167	1			

- Molecule 69 is a protein called 60S ribosomal protein L33-A.

Mol	Chain	Residues	Atoms					ZeroOcc	AltConf	Trace
69	O3	106	Total	C	N	O	S	0	0	0
			850	540	165	144	1			
69	o3	106	Total	C	N	O	S	0	0	0
			850	540	165	144	1			

- Molecule 70 is a protein called 60S ribosomal protein L34-A.

Mol	Chain	Residues	Atoms					ZeroOcc	AltConf	Trace
70	O4	112	Total	C	N	O	S	0	0	0
			880	545	179	152	4			
70	o4	112	Total	C	N	O	S	0	0	0
			880	545	179	152	4			

- Molecule 71 is a protein called 60S ribosomal protein L35-A.

Mol	Chain	Residues	Atoms					ZeroOcc	AltConf	Trace
71	O5	119	Total	C	N	O	S	0	0	0
			969	615	186	167	1			
71	o5	119	Total	C	N	O	S	0	0	0
			965	612	185	167	1			

- Molecule 72 is a protein called 60S ribosomal protein L36-A.

Mol	Chain	Residues	Atoms					ZeroOcc	AltConf	Trace
72	O6	99	Total	C	N	O	S	0	0	0
			771	481	156	132	2			
72	o6	99	Total	C	N	O	S	0	0	0
			770	481	156	131	2			

- Molecule 73 is a protein called 60S ribosomal protein L37-A.

Mol	Chain	Residues	Atoms					ZeroOcc	AltConf	Trace
73	O7	87	Total	C	N	O	S	0	0	0
			681	414	148	114	5			
73	o7	87	Total	C	N	O	S	0	0	0
			681	414	148	114	5			

- Molecule 74 is a protein called 60S ribosomal protein L38.

Mol	Chain	Residues	Atoms				ZeroOcc	AltConf	Trace
74	O8	77	Total	C	N	O	0	0	0
			612	391	115	106			
74	o8	77	Total	C	N	O	0	0	0
			608	388	114	106			

- Molecule 75 is a protein called 60S ribosomal protein L39.

Mol	Chain	Residues	Atoms					ZeroOcc	AltConf	Trace
75	O9	50	Total	C	N	O	S	0	0	0
			436	272	97	65	2			
75	o9	50	Total	C	N	O	S	0	0	0
			436	272	97	65	2			

- Molecule 76 is a protein called Ubiquitin-60S ribosomal protein L40.

Mol	Chain	Residues	Atoms					ZeroOcc	AltConf	Trace
76	Q0	52	Total	C	N	O	S	0	0	0
			417	259	86	67	5			
76	q0	52	Total	C	N	O	S	0	0	0
			417	259	86	67	5			

- Molecule 77 is a protein called 60S ribosomal protein L41-A.

Mol	Chain	Residues	Atoms					ZeroOcc	AltConf	Trace
77	Q1	25	Total	C	N	O	S	0	0	0
			233	142	63	27	1			
77	q1	25	Total	C	N	O	S	0	0	0
			233	142	63	27	1			

- Molecule 78 is a protein called 60S ribosomal protein L42-A.

Mol	Chain	Residues	Atoms					ZeroOcc	AltConf	Trace
78	Q2	105	Total	C	N	O	S	0	0	0
			847	534	170	138	5			
78	q2	105	Total	C	N	O	S	0	0	0
			847	534	170	138	5			

- Molecule 79 is a protein called 60S ribosomal protein L43-A.

Mol	Chain	Residues	Atoms					ZeroOcc	AltConf	Trace
79	Q3	91	Total	C	N	O	S	0	0	0
			694	429	138	121	6			
79	q3	91	Total	C	N	O	S	0	0	0
			694	429	138	121	6			

- Molecule 80 is a protein called 60S ribosomal protein L12-A (uL11).

Mol	Chain	Residues	Atoms				ZeroOcc	AltConf	Trace
80	m2	150	Total	C	N	O	0	0	0
			750	450	150	150			

- Molecule 81 is a protein called 60S acidic ribosomal protein P0.

Mol	Chain	Residues	Atoms					ZeroOcc	AltConf	Trace
81	p0	143	Total	C	N	O	S	0	0	0
			1077	687	192	195	3			

- Molecule 82 is a protein called 60S ribosomal protein P1 alpha/P2 beta.

Mol	Chain	Residues	Atoms				ZeroOcc	AltConf	Trace
82	p1	47	Total	C	N	O	0	0	0
			235	141	47	47			
82	p2	46	Total	C	N	O	0	0	0
			230	138	46	46			

- Molecule 83 is a protein called Eukaryotic translation initiation factor 5A-1.

Mol	Chain	Residues	Atoms					ZeroOcc	AltConf	Trace
83	f	148	Total	C	N	O	S	0	0	0
			1116	692	188	227	9			

- Molecule 84 is a protein called CH-CH-8AN-PRO-PRO.

Mol	Chain	Residues	Atoms					ZeroOcc	AltConf	Trace
84	B	5	Total	C	N	O	P	0	0	0
			76	38	14	21	3			
84	C	5	Total	C	N	O	P	0	0	0
			73	38	14	19	2			

- Molecule 85 is ZINC ION (three-letter code: ZN) (formula: Zn).

Mol	Chain	Residues	Atoms	ZeroOcc	AltConf
85	D6	1	Total Zn 1 1	0	0
85	D7	1	Total Zn 1 1	0	0
85	D9	1	Total Zn 1 1	0	0
85	E1	1	Total Zn 1 1	0	0
85	O7	1	Total Zn 1 1	0	0
85	Q0	1	Total Zn 1 1	0	0
85	Q2	1	Total Zn 1 1	0	0
85	Q3	1	Total Zn 1 1	0	0
85	d6	1	Total Zn 1 1	0	0
85	d7	1	Total Zn 1 1	0	0
85	d9	1	Total Zn 1 1	0	0
85	e1	1	Total Zn 1 1	0	0
85	o7	1	Total Zn 1 1	0	0
85	q0	1	Total Zn 1 1	0	0
85	q2	1	Total Zn 1 1	0	0
85	q3	1	Total Zn 1 1	0	0

- Molecule 86 is SPARSOMYCIN (three-letter code: SPS) (formula: $C_{13}H_{19}N_3O_5S_2$).

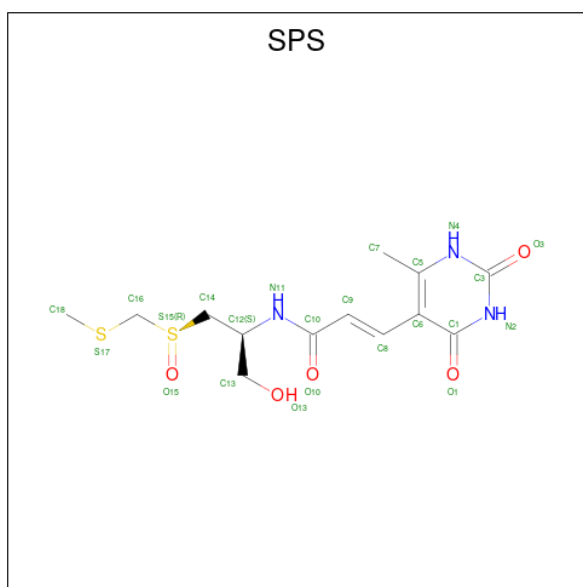

Mol	Chain	Residues	Atoms					ZeroOcc	AltConf
86	1	1	Total	C	N	O	S	0	0
			23	13	3	5	2		
86	B	1	Total	C	N	O	S	0	0
			23	13	3	5	2		

- Molecule 87 is MAGNESIUM ION (three-letter code: MG) (formula: Mg).

Mol	Chain	Residues	Atoms		ZeroOcc	AltConf
87	1	3	Total	Mg	0	0
			3	3		
87	5	5	Total	Mg	0	0
			5	5		
87	f	2	Total	Mg	0	0
			2	2		
87	B	1	Total	Mg	0	0
			1	1		
87	C	1	Total	Mg	0	0
			1	1		

- Molecule 88 is osmium (III) hexammine (three-letter code: OHX) (formula: H₁₂N₆Os).

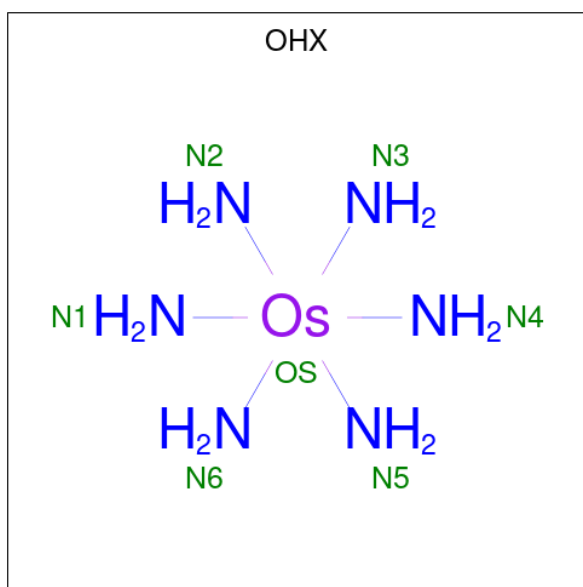

Mol	Chain	Residues	Atoms			ZeroOcc	AltConf
88	1	1	Total	N	Os	0	0
			7	6	1		
88	1	1	Total	N	Os	0	0
			7	6	1		
88	5	1	Total	N	Os	0	0
			7	6	1		

- Molecule 89 is water.

Mol	Chain	Residues	Atoms		ZeroOcc	AltConf
89	5	2	Total	O	0	0
			2	2		
89	f	10	Total	O	0	0
			10	10		

3 Residue-property plots

These plots are drawn for all protein, RNA, DNA and oligosaccharide chains in the entry. The first graphic for a chain summarises the proportions of the various outlier classes displayed in the second graphic. The second graphic shows the sequence view annotated by issues in geometry and electron density. Residues are color-coded according to the number of geometric quality criteria for which they contain at least one outlier: green = 0, yellow = 1, orange = 2 and red = 3 or more. A red dot above a residue indicates a poor fit to the electron density ($RSRZ > 2$). Stretches of 2 or more consecutive residues without any outlier are shown as a green connector. Residues present in the sample, but not in the model, are shown in grey.

- Molecule 1: 18S ribosomal RNA

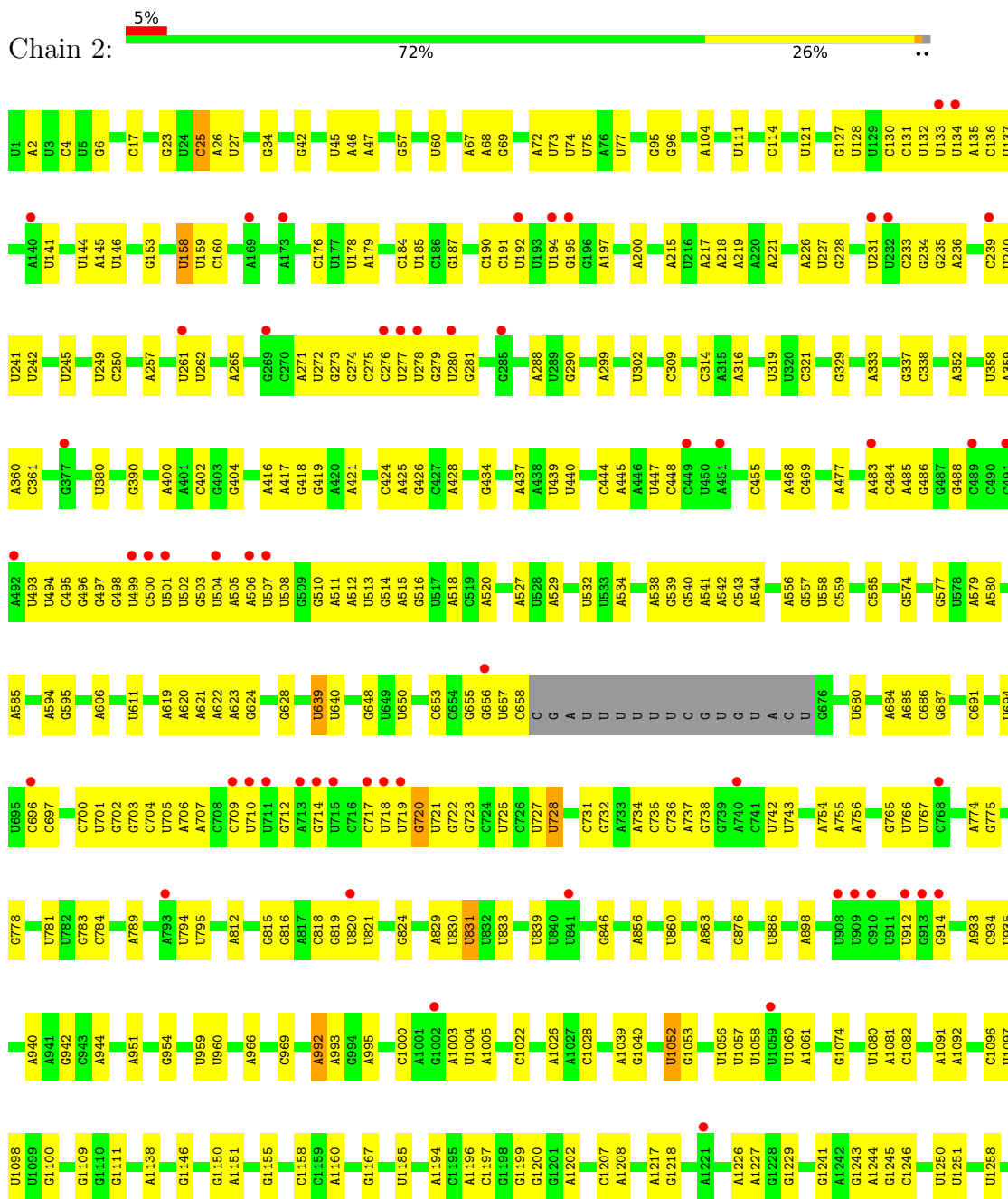

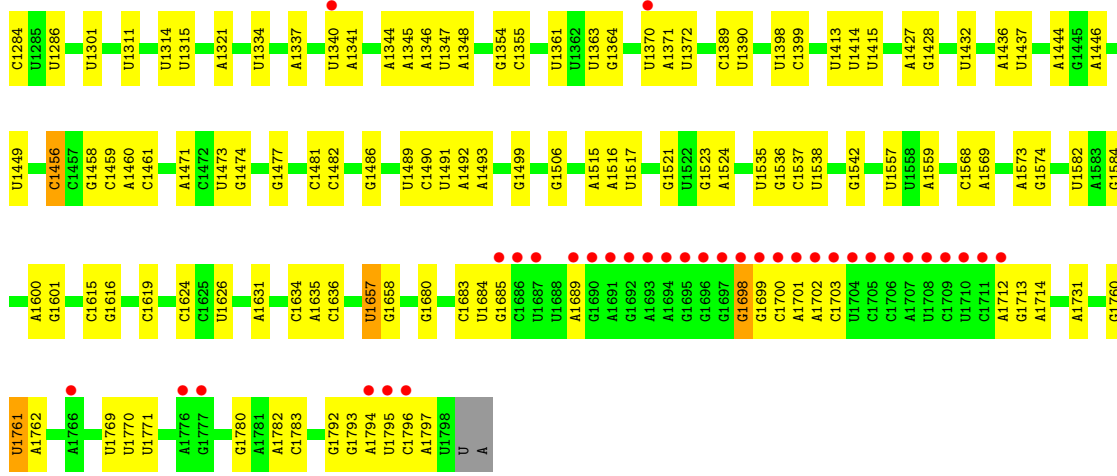

• Molecule 1: 18S ribosomal RNA

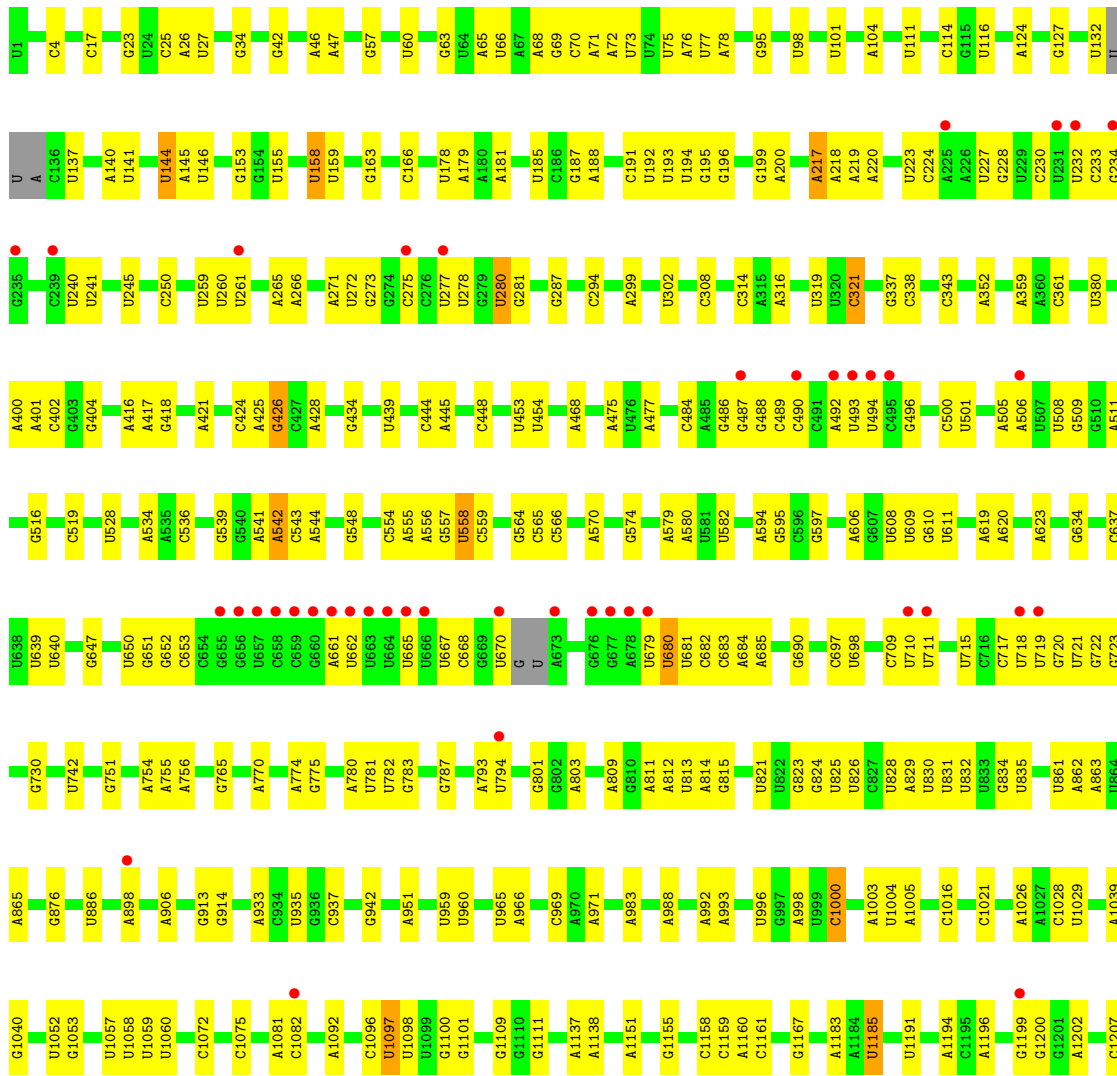
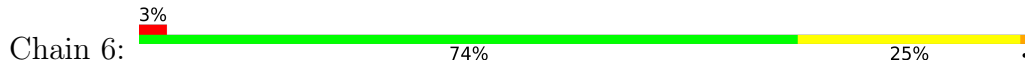

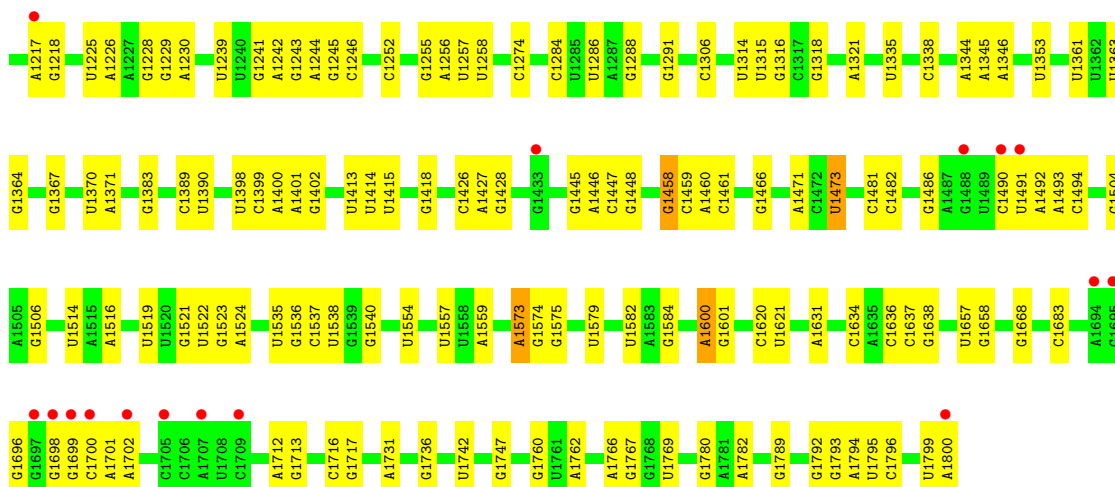

• Molecule 2: 40S ribosomal protein S0-A

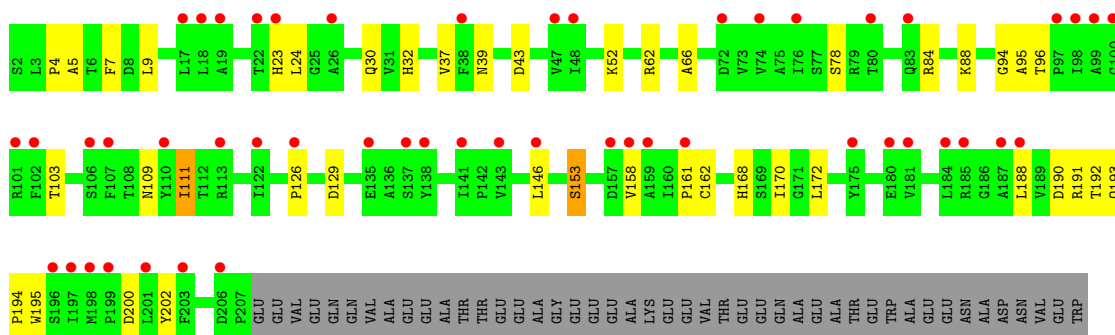

• Molecule 2: 40S ribosomal protein S0-A

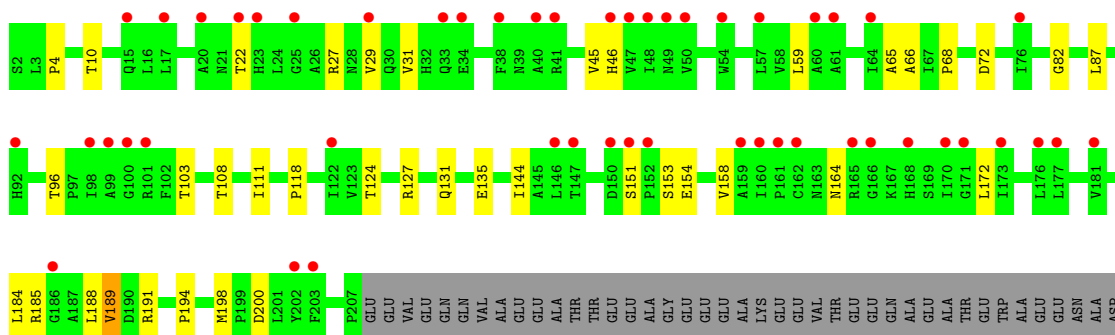

• Molecule 3: 40S ribosomal protein S1-A



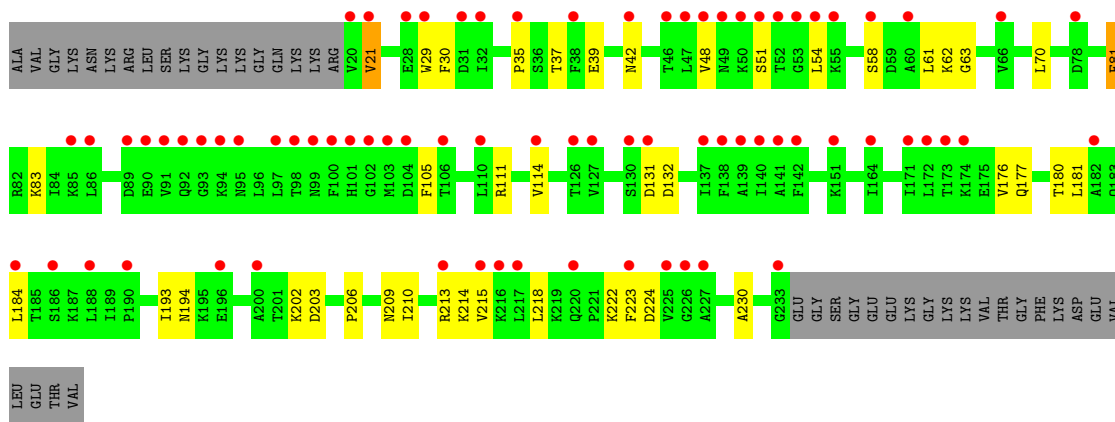

• Molecule 3: 40S ribosomal protein S1-A

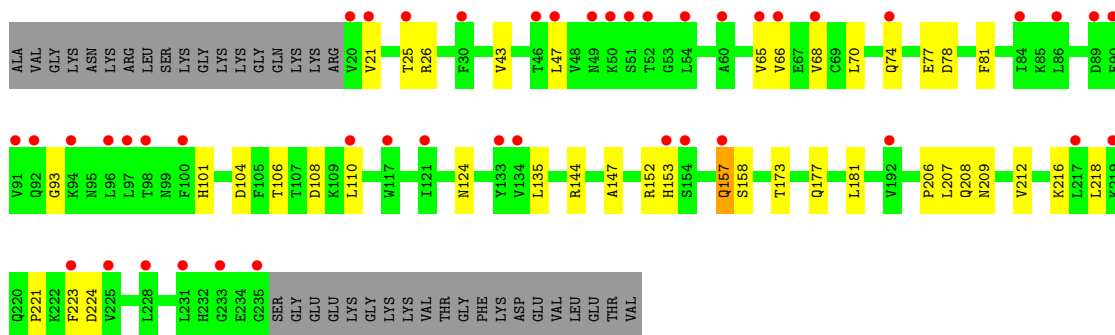

• Molecule 4: 40S ribosomal protein S2

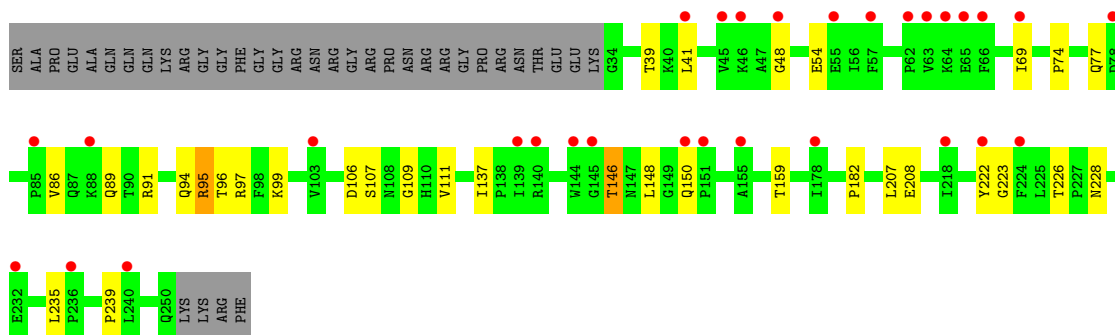
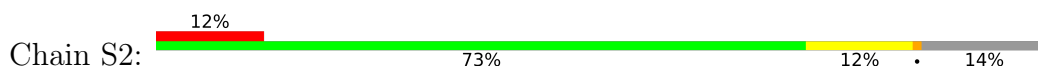

• Molecule 4: 40S ribosomal protein S2

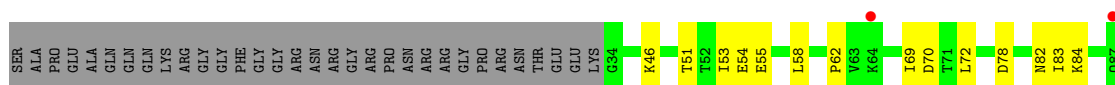

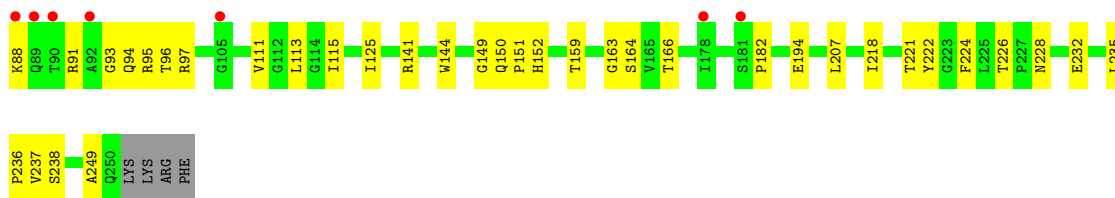

• Molecule 5: 40S ribosomal protein S3

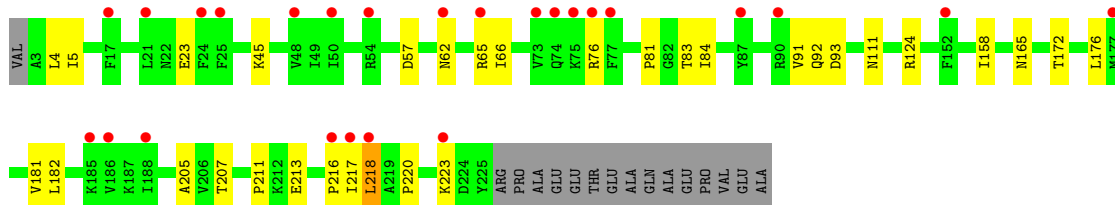
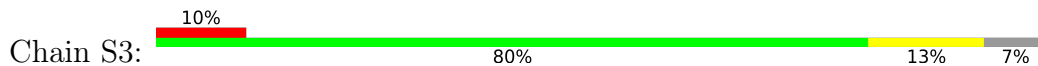

• Molecule 5: 40S ribosomal protein S3

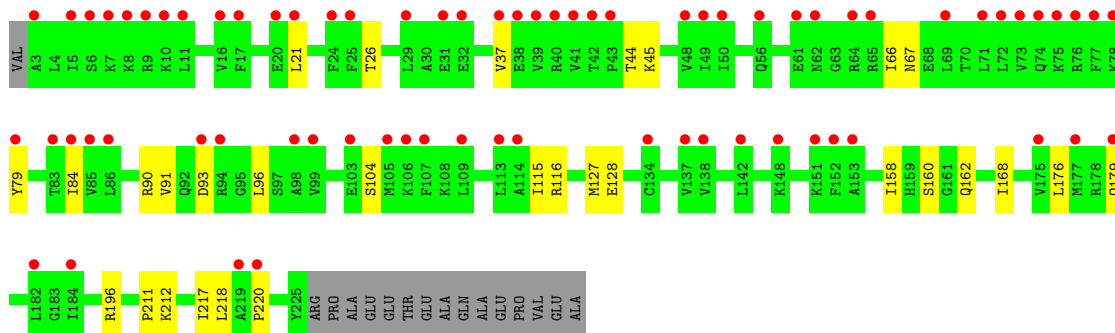
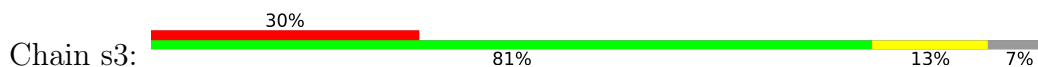

• Molecule 6: 40S ribosomal protein S4-A

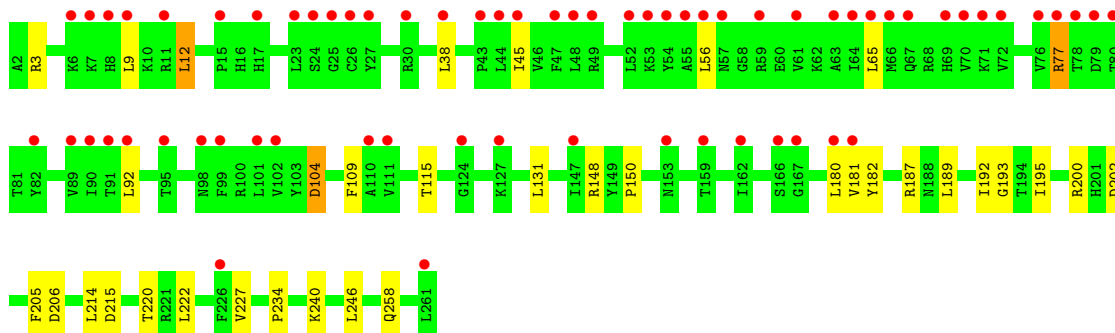
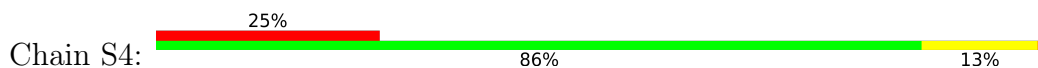

• Molecule 6: 40S ribosomal protein S4-A

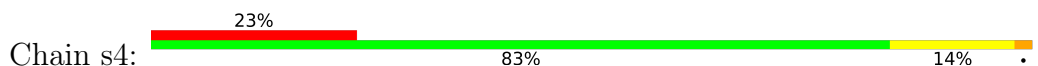

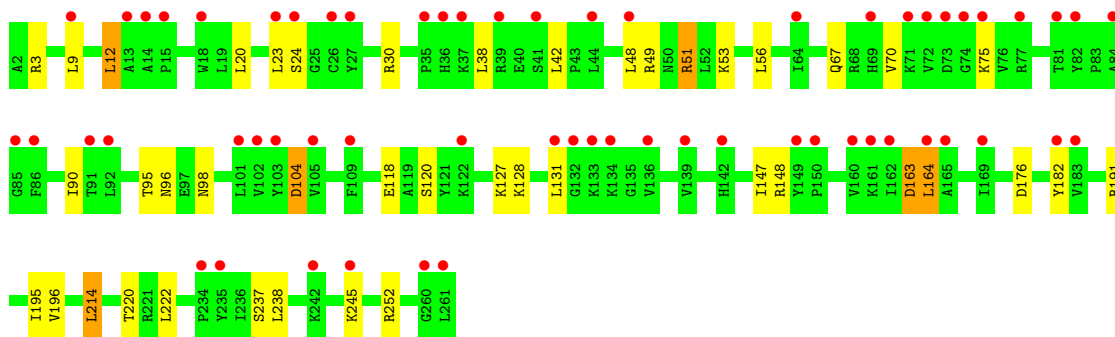

• Molecule 7: 40S ribosomal protein S5

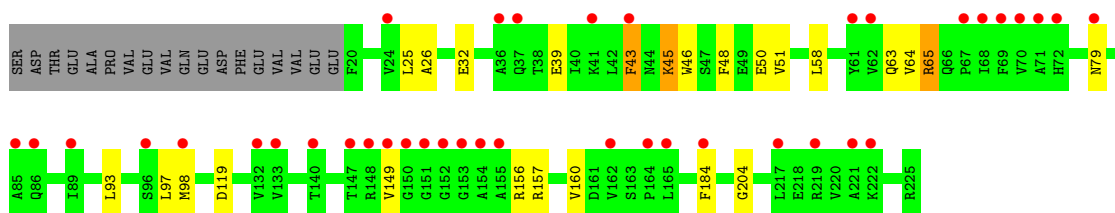
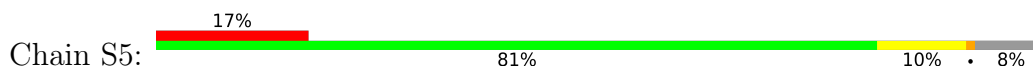

• Molecule 7: 40S ribosomal protein S5

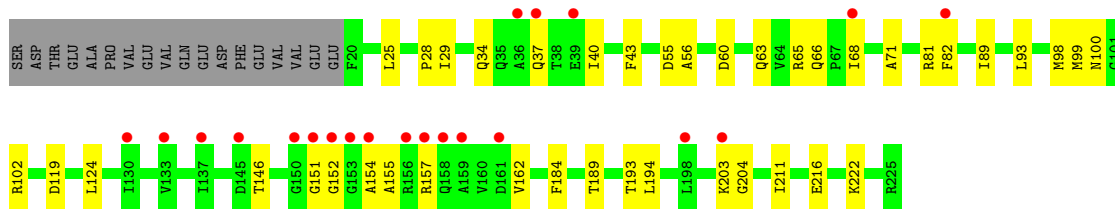
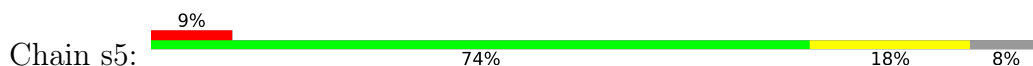

• Molecule 8: 40S ribosomal protein S6-A

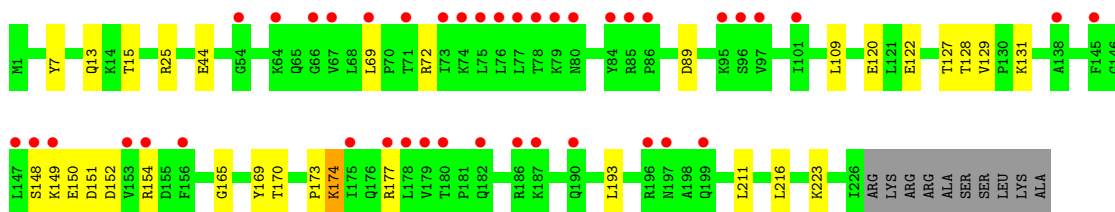
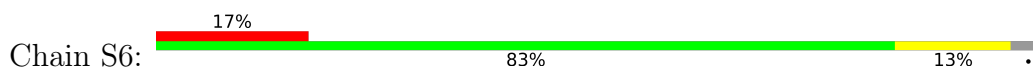

• Molecule 8: 40S ribosomal protein S6-A

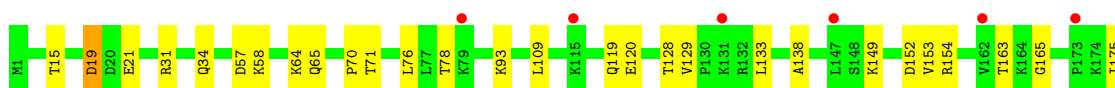
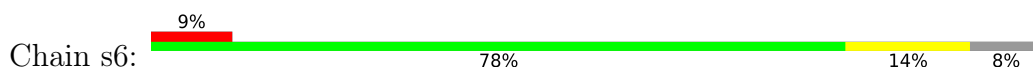

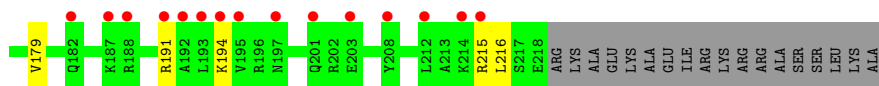

• Molecule 9: 40S ribosomal protein S7-A

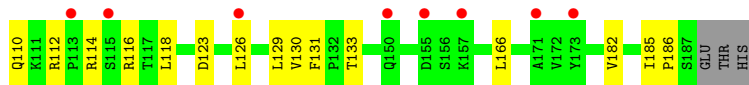
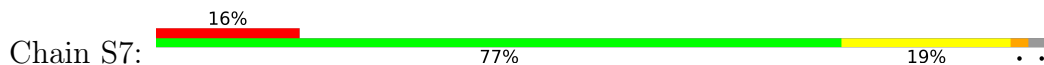

• Molecule 9: 40S ribosomal protein S7-A

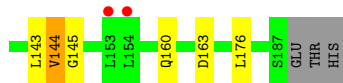
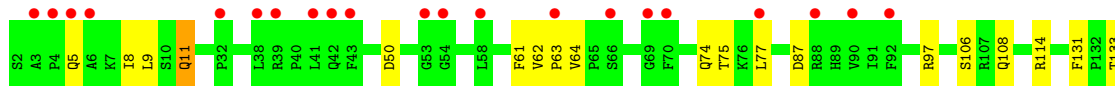
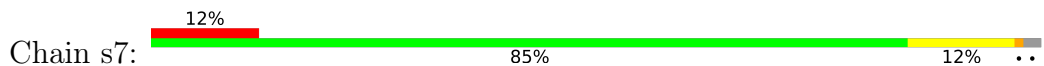

• Molecule 10: 40S ribosomal protein S8-A

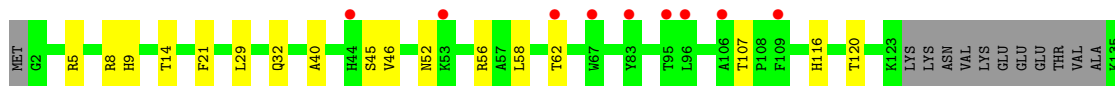
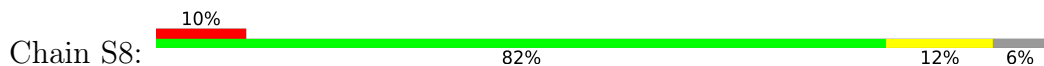

• Molecule 10: 40S ribosomal protein S8-A

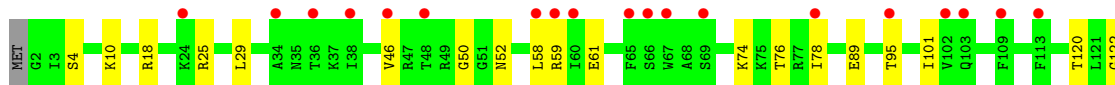
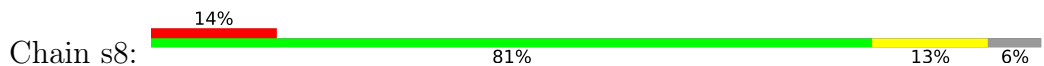

• Molecule 11: 40S ribosomal protein S9-A

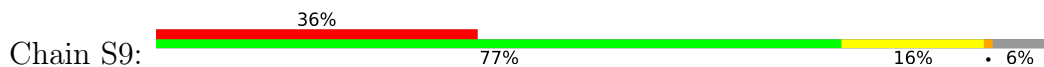

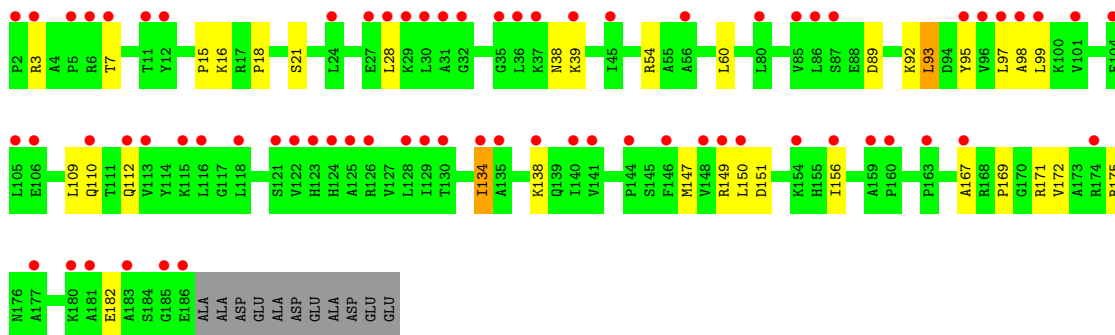

• Molecule 11: 40S ribosomal protein S9-A

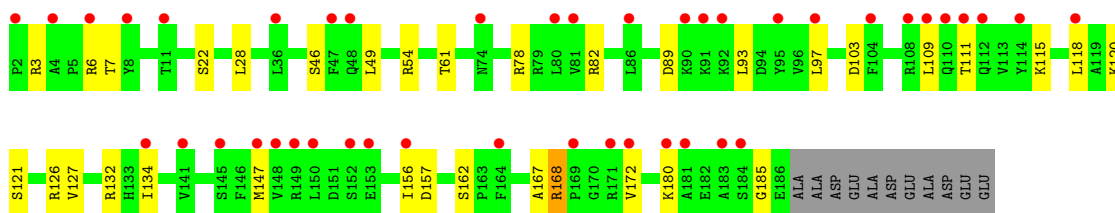
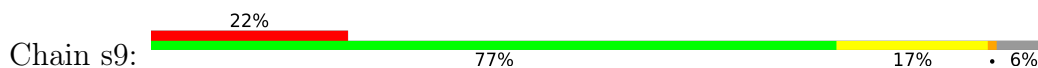

• Molecule 12: 40S ribosomal protein S10-A

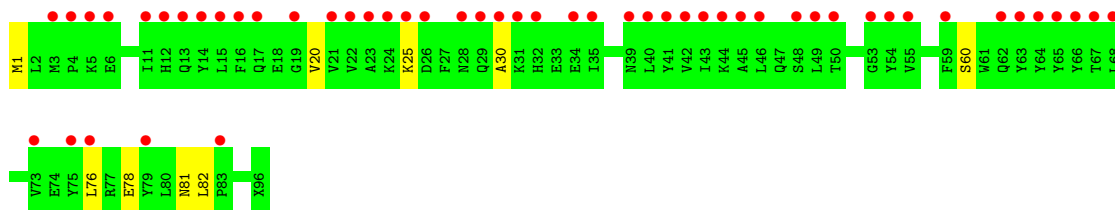
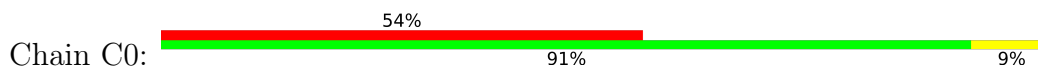

• Molecule 12: 40S ribosomal protein S10-A

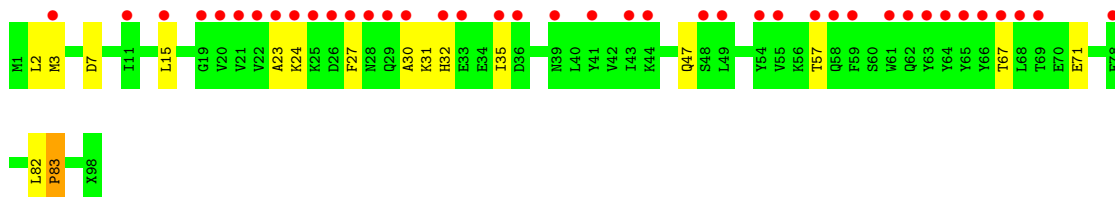
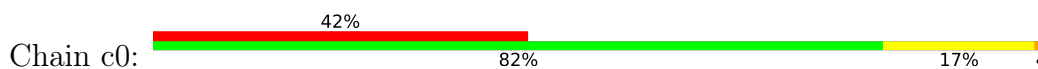

• Molecule 13: 40S ribosomal protein S11-A

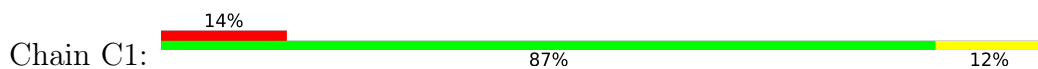



● Molecule 13: 40S ribosomal protein S11-A

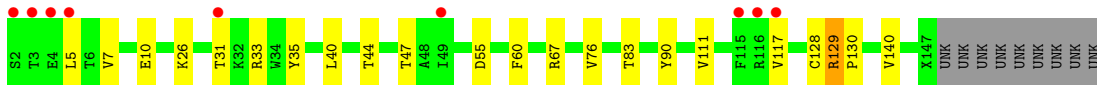
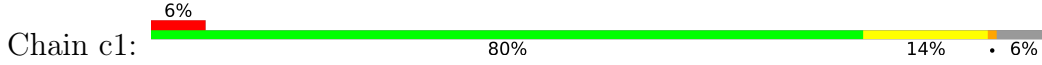

● Molecule 14: 40S ribosomal protein S12

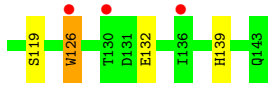

● Molecule 14: 40S ribosomal protein S12

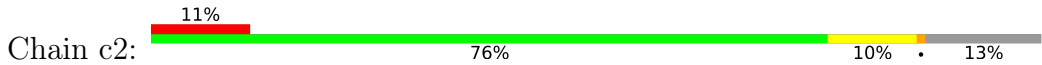

● Molecule 15: 40S ribosomal protein S13

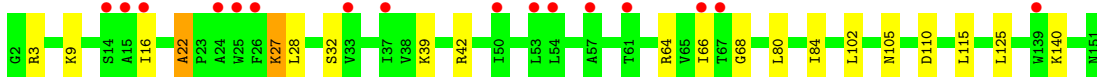
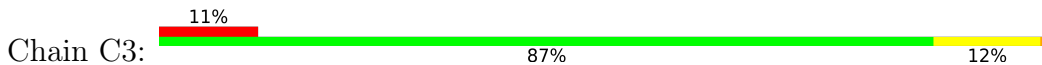

● Molecule 15: 40S ribosomal protein S13

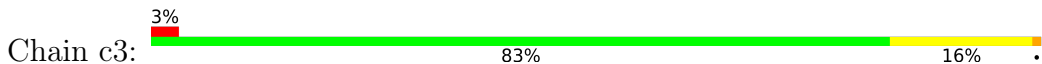

● Molecule 16: 40S ribosomal protein S14-A

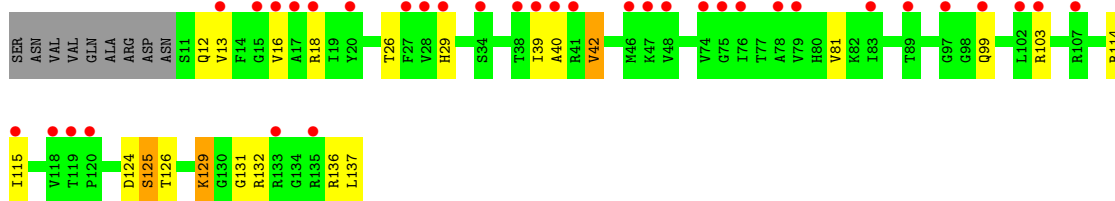
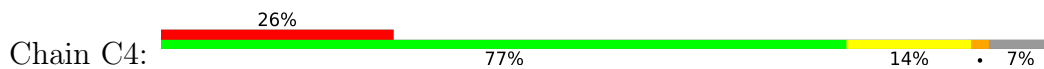

• Molecule 16: 40S ribosomal protein S14-A

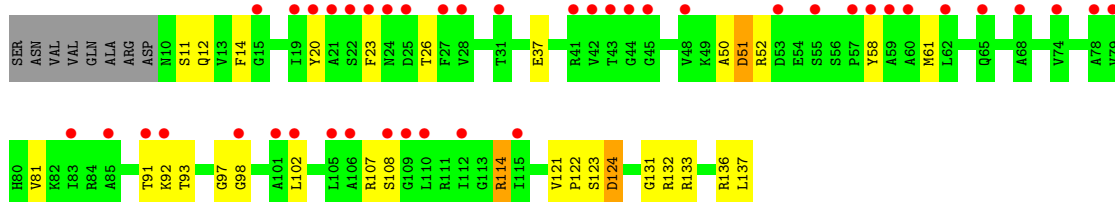

• Molecule 17: 40S ribosomal protein S15 (uS19)

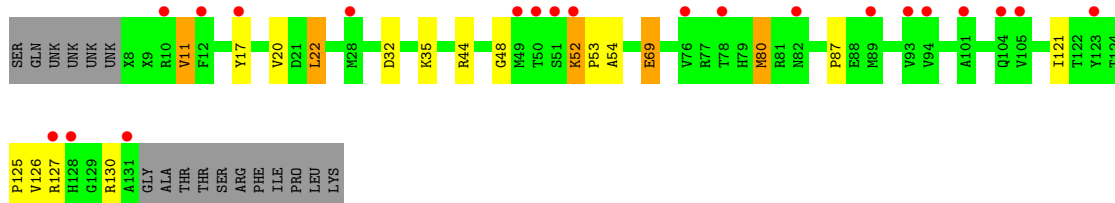
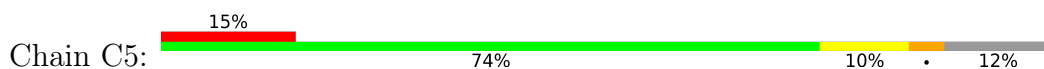

• Molecule 17: 40S ribosomal protein S15 (uS19)

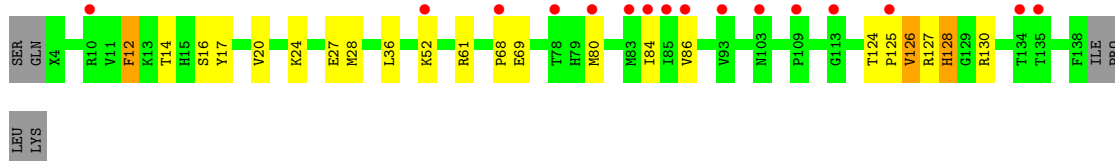
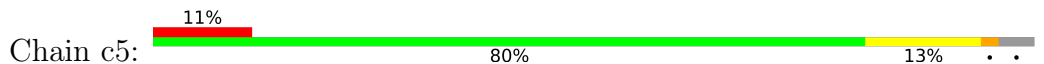

• Molecule 18: 40S ribosomal protein S16-A

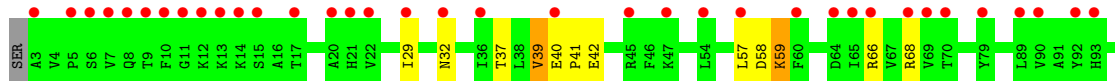
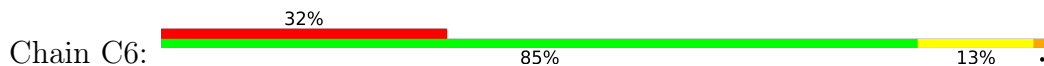



- Molecule 18: 40S ribosomal protein S16-A

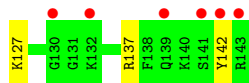
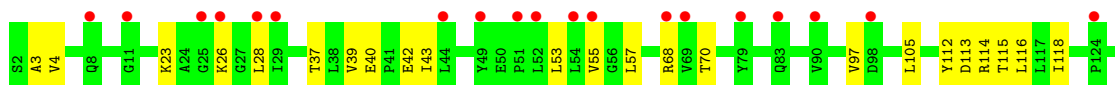
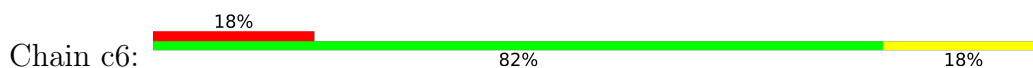

- Molecule 19: 40S ribosomal protein S17-A

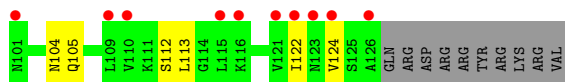
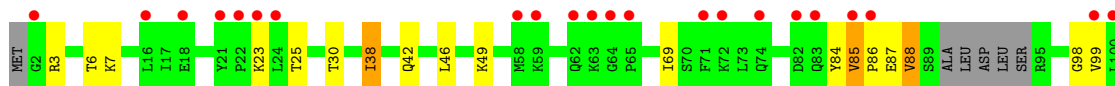
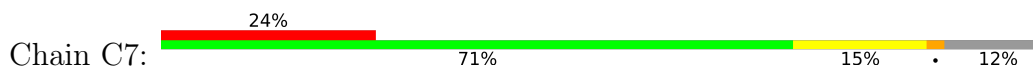

- Molecule 19: 40S ribosomal protein S17-A

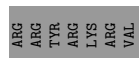
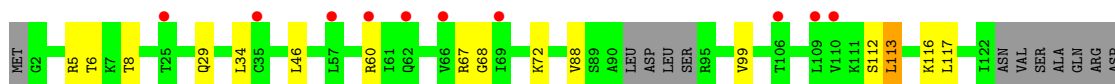
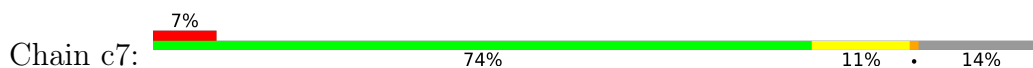

- Molecule 20: 40S ribosomal protein S18-A

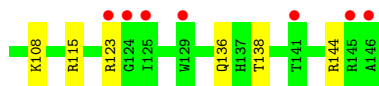
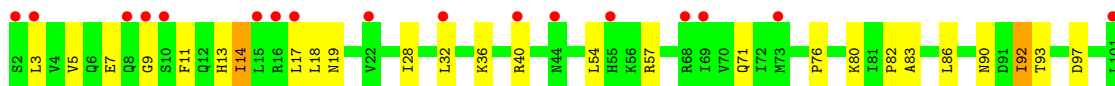
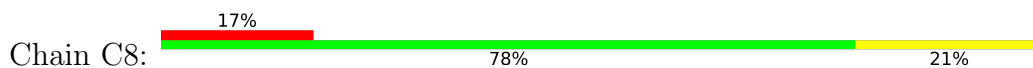

- Molecule 20: 40S ribosomal protein S18-A

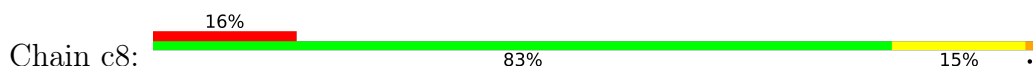

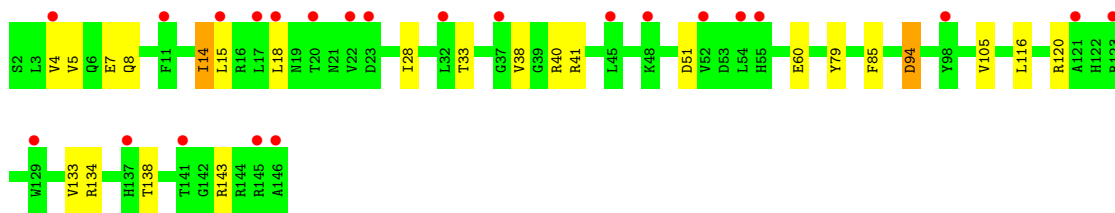

• Molecule 21: 40S ribosomal protein S19-A

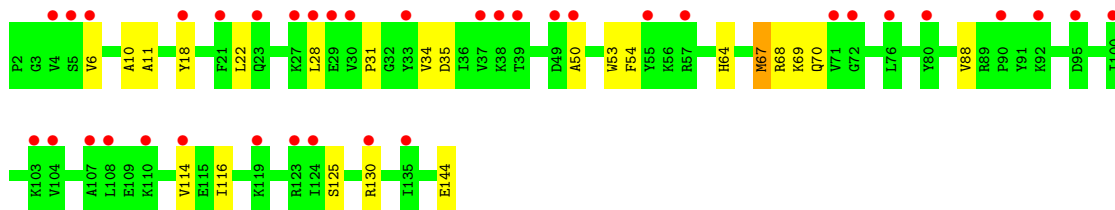
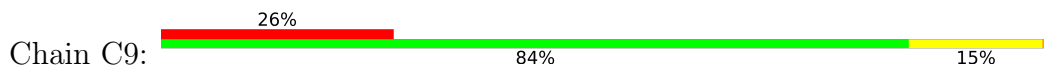

• Molecule 21: 40S ribosomal protein S19-A

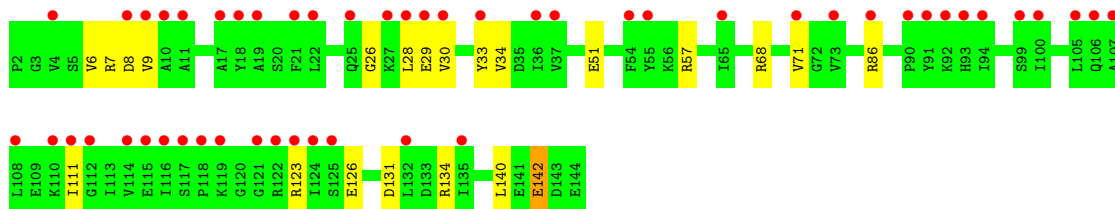
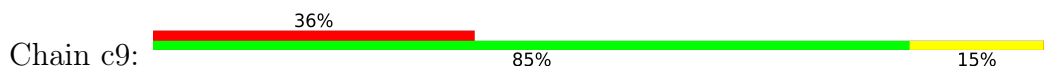

• Molecule 22: 40S ribosomal protein S20

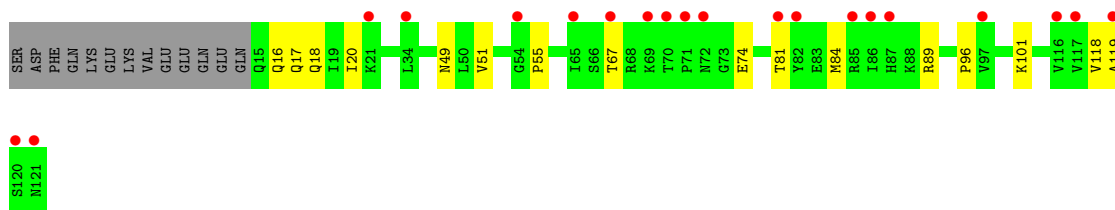
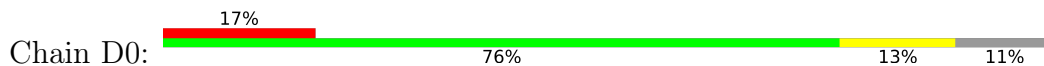

• Molecule 22: 40S ribosomal protein S20

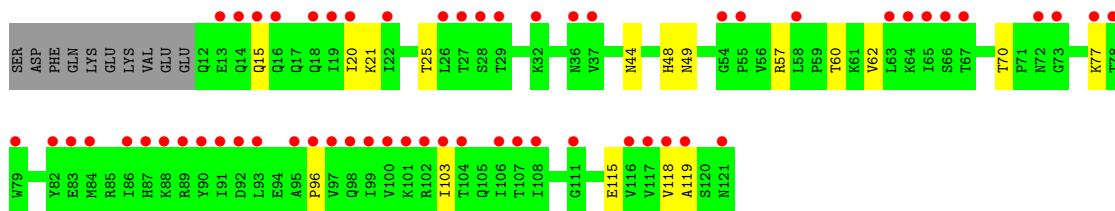
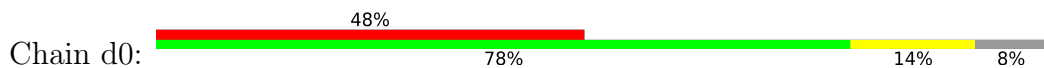

- Molecule 23: 40S ribosomal protein S21-A

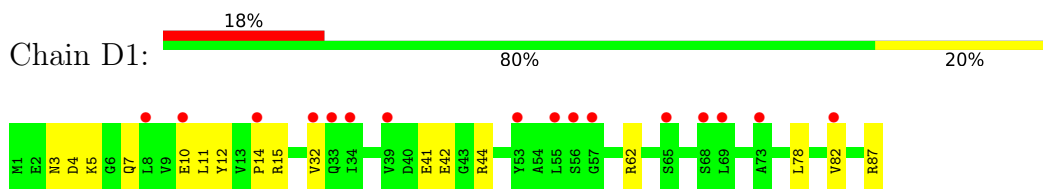

- Molecule 23: 40S ribosomal protein S21-A

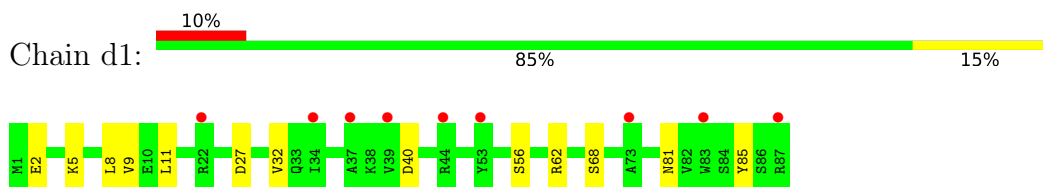

- Molecule 24: 40S ribosomal protein S22-A

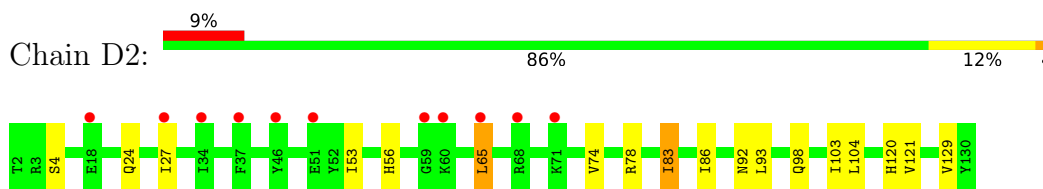

- Molecule 24: 40S ribosomal protein S22-A

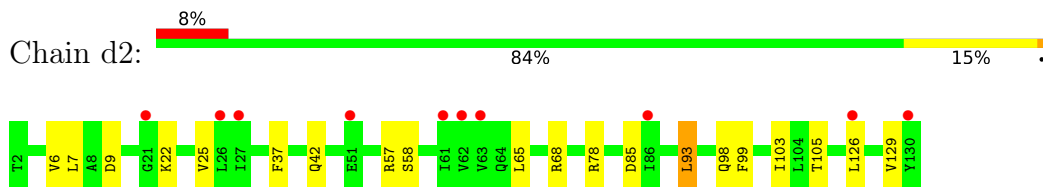

- Molecule 25: 40S ribosomal protein S23-A

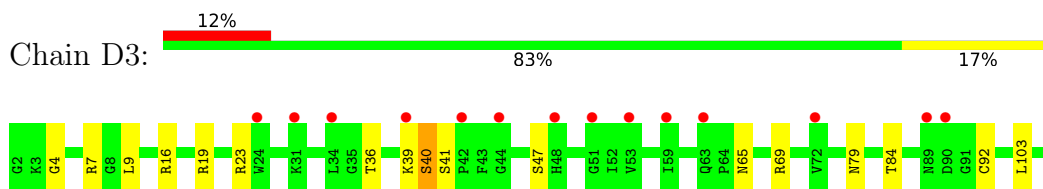

- Molecule 25: 40S ribosomal protein S23-A

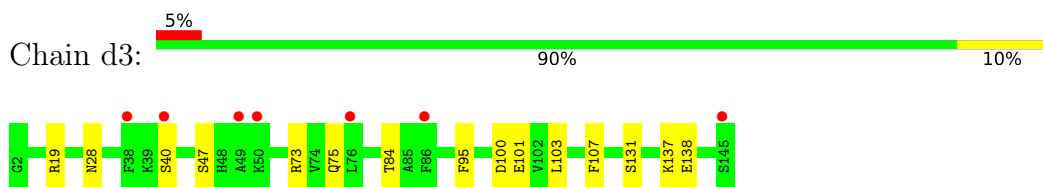

- Molecule 26: 40S ribosomal protein S24-A

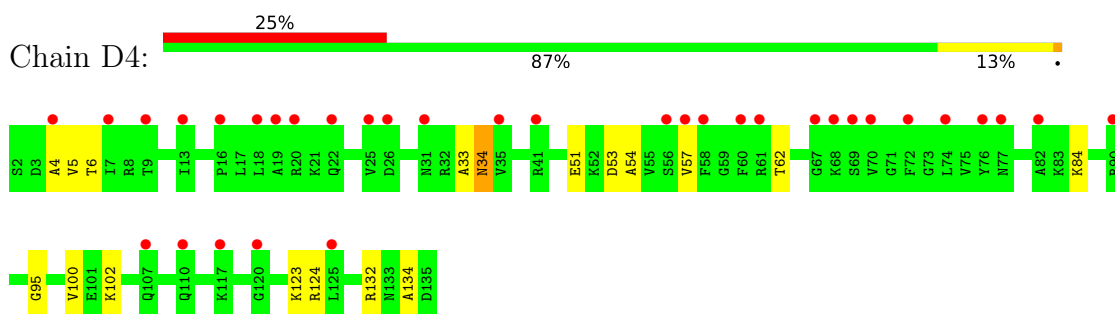

- Molecule 26: 40S ribosomal protein S24-A

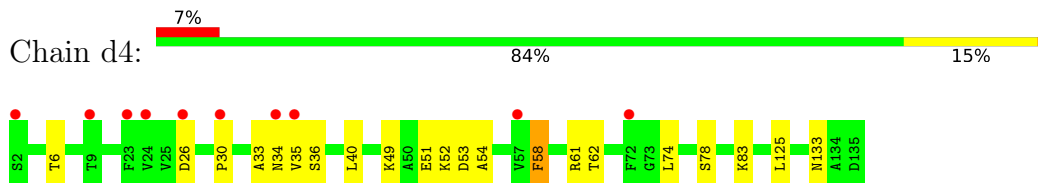

- Molecule 27: 40S ribosomal protein S25-A

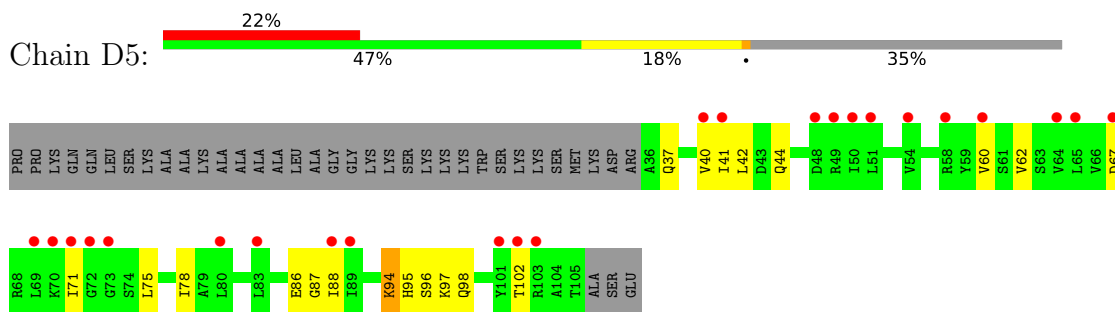

- Molecule 27: 40S ribosomal protein S25-A

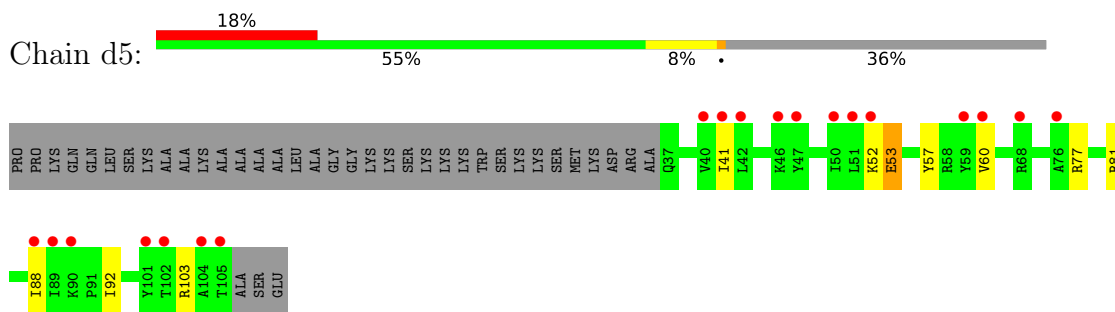

- Molecule 28: 40S ribosomal protein S26-B

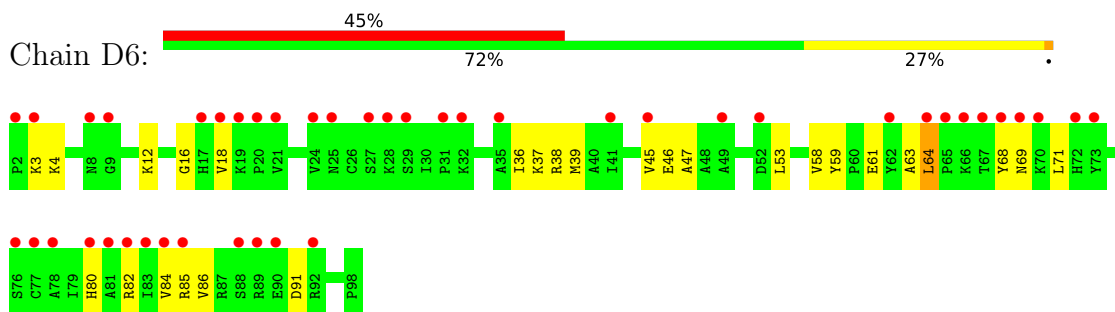

- Molecule 28: 40S ribosomal protein S26-B

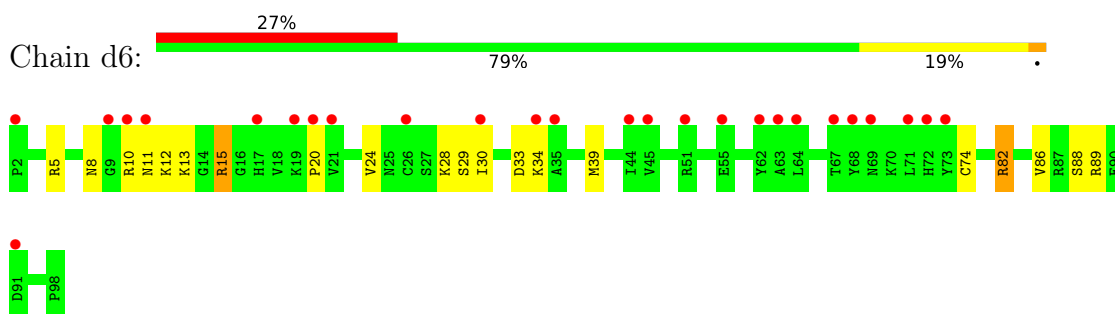

- Molecule 29: 40S ribosomal protein S27-A

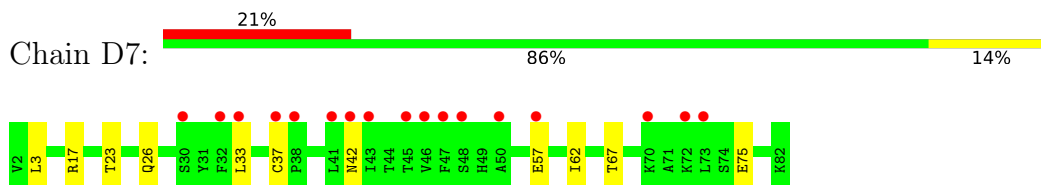

- Molecule 29: 40S ribosomal protein S27-A

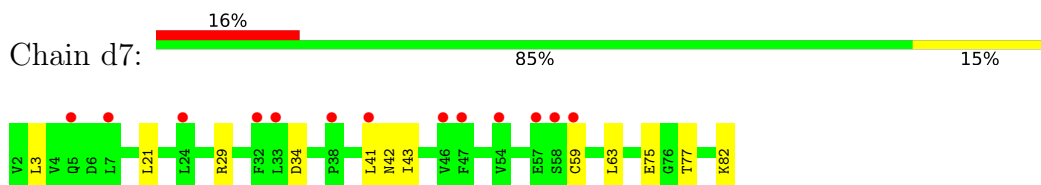

- Molecule 30: 40S ribosomal protein S28-A

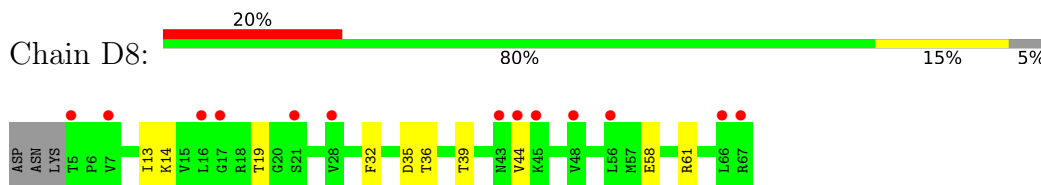

- Molecule 30: 40S ribosomal protein S28-A

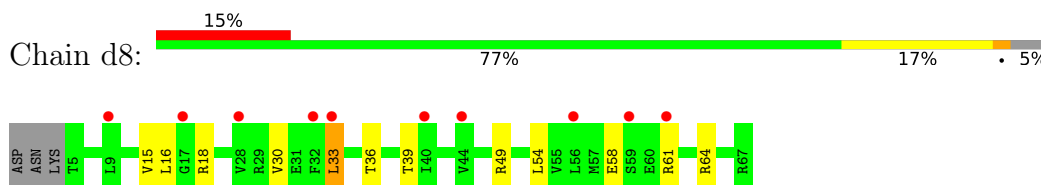

- Molecule 31: 40S ribosomal protein S29-A

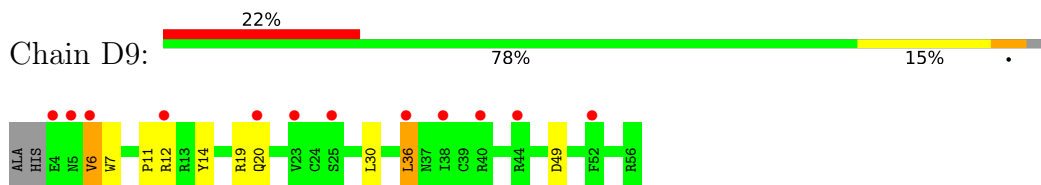

- Molecule 31: 40S ribosomal protein S29-A





- Molecule 32: 40S ribosomal protein S30-A

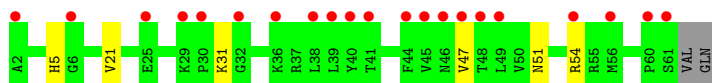
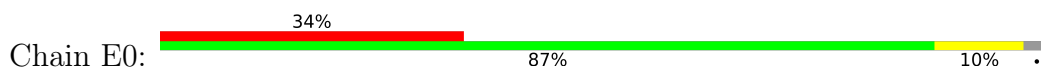

- Molecule 32: 40S ribosomal protein S30-A



- Molecule 33: Ubiquitin-40S ribosomal protein S31



- Molecule 33: Ubiquitin-40S ribosomal protein S31

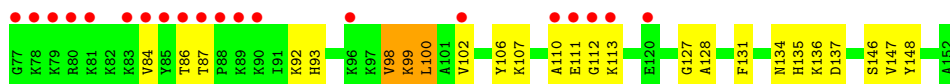

- Molecule 34: Guanine nucleotide-binding protein subunit beta-like protein

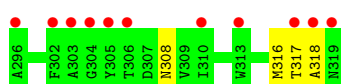
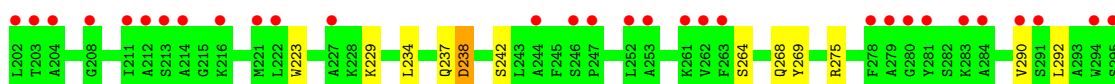
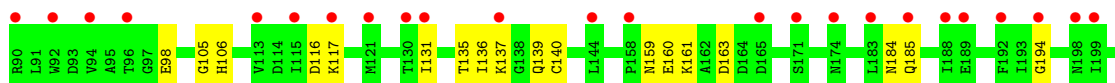
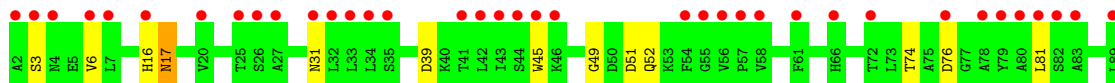
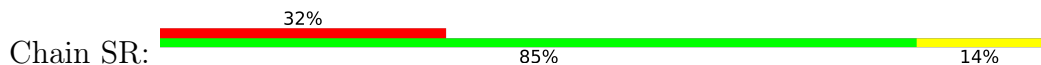

● Molecule 34: Guanine nucleotide-binding protein subunit beta-like protein

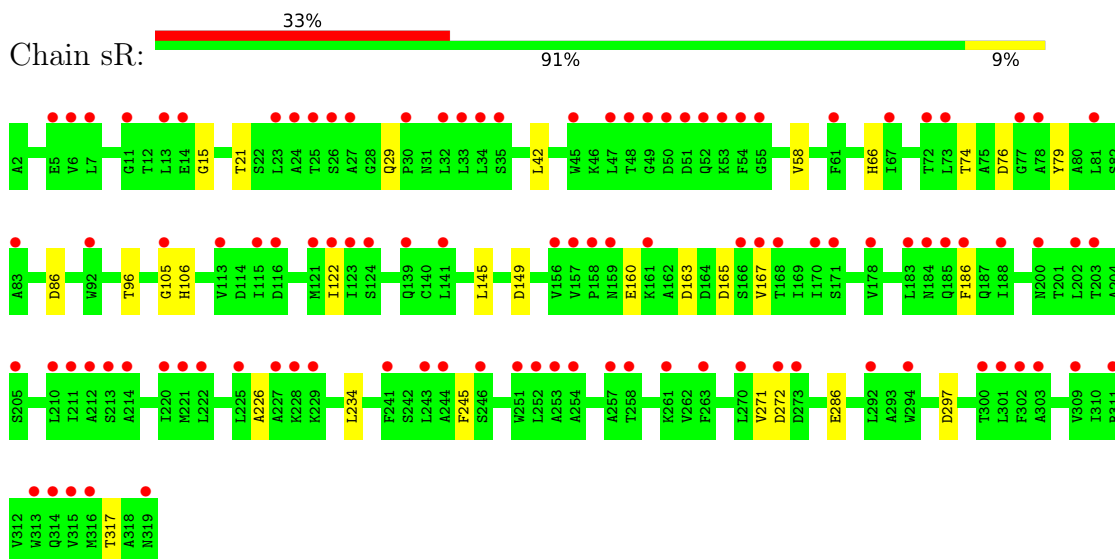

● Molecule 35: Suppressor protein STM1

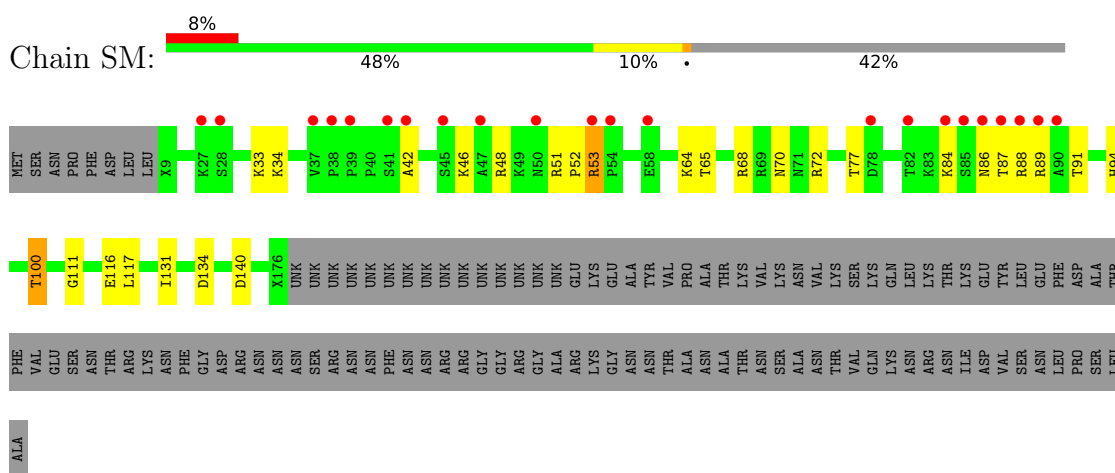

● Molecule 35: Suppressor protein STM1

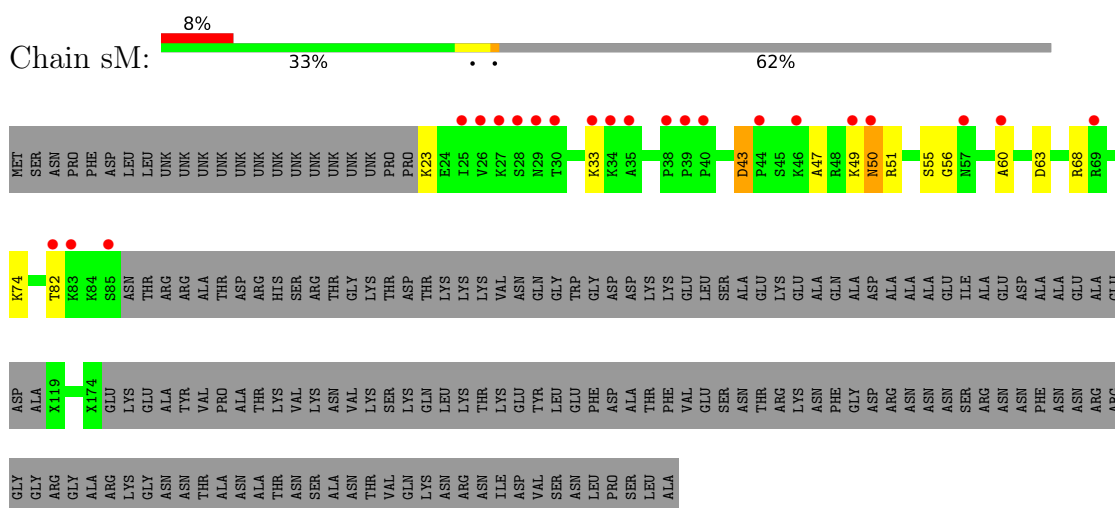

• Molecule 36: 25S ribosomal RNA

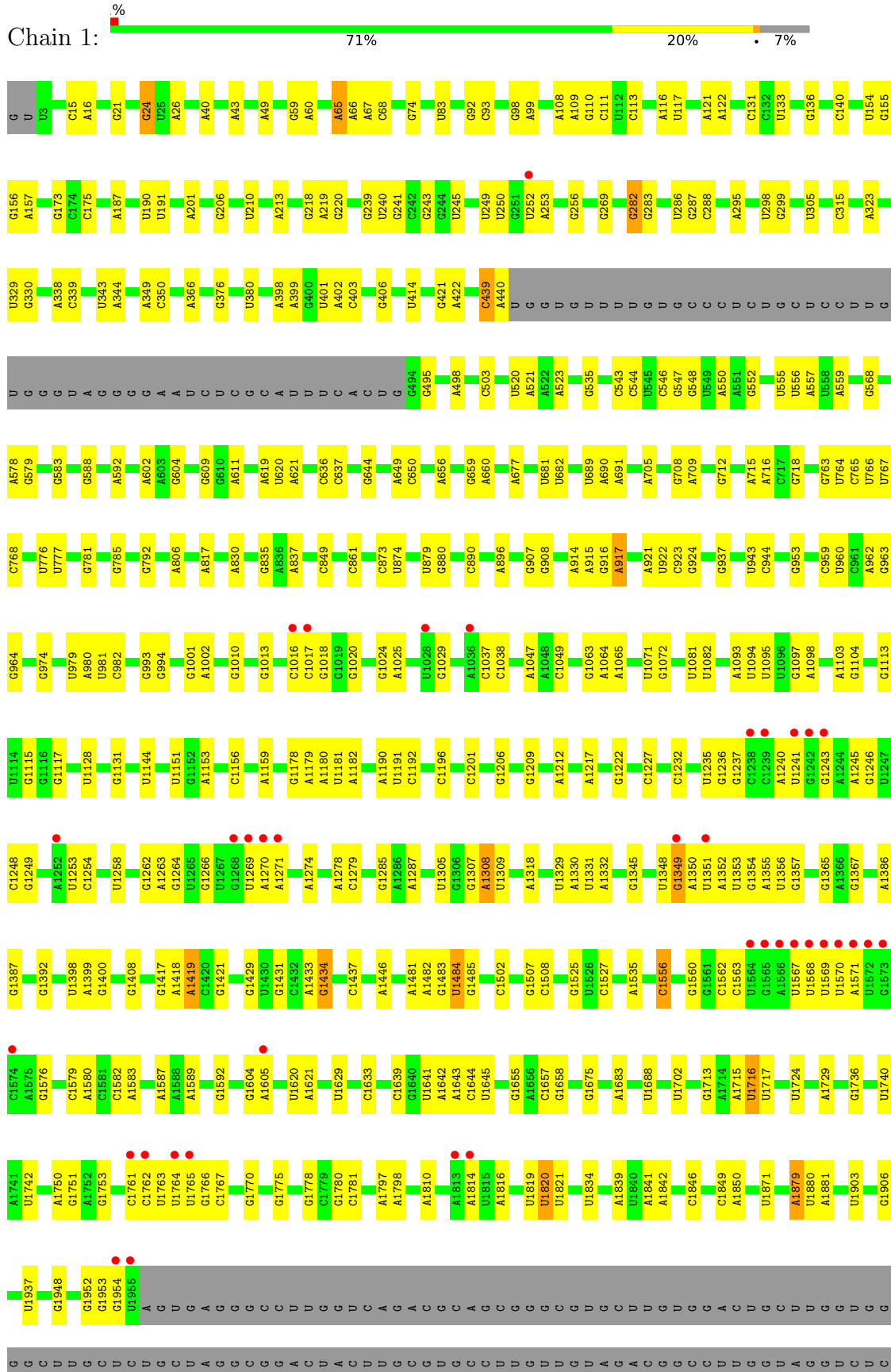

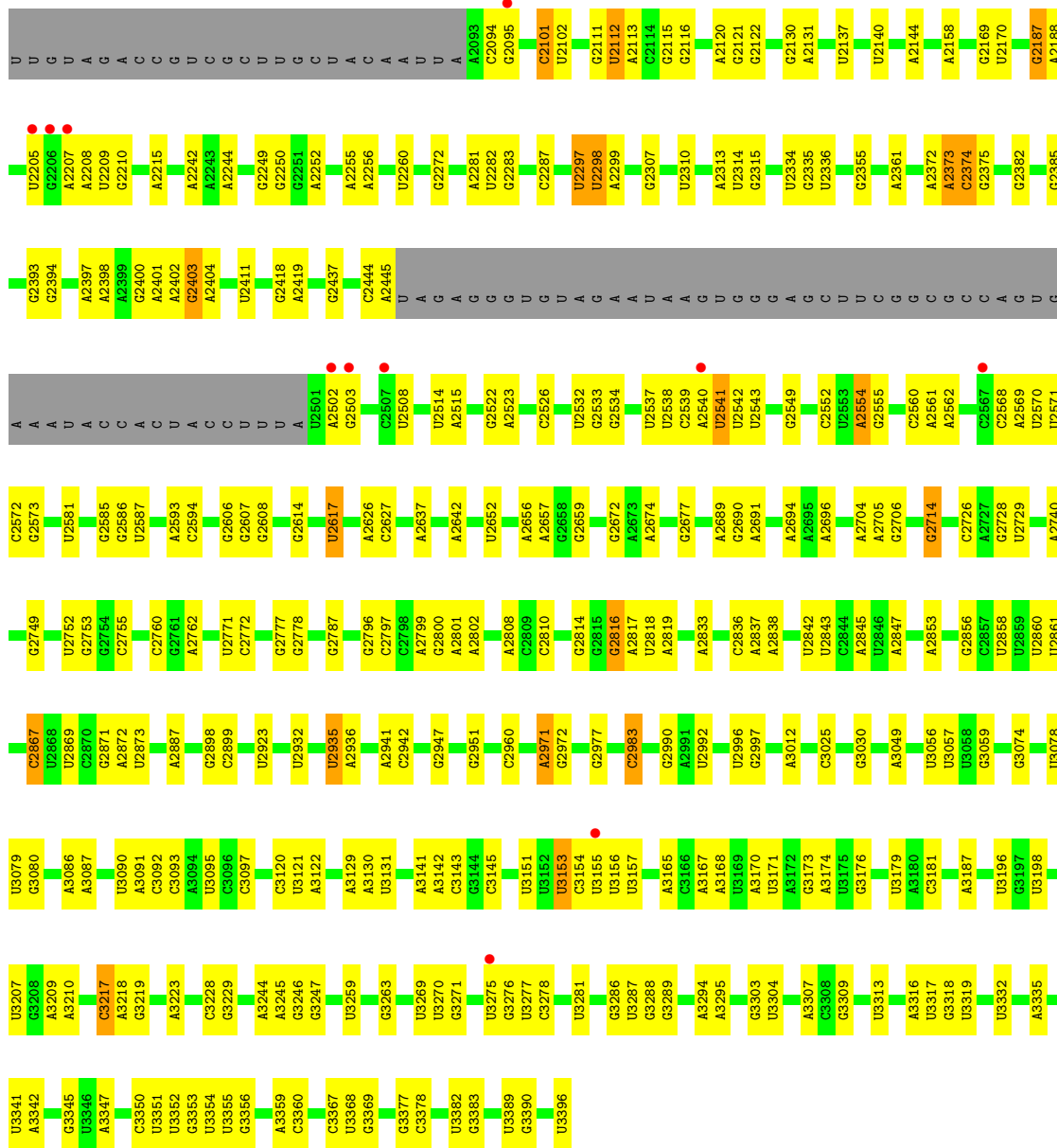

• Molecule 36: 25S ribosomal RNA

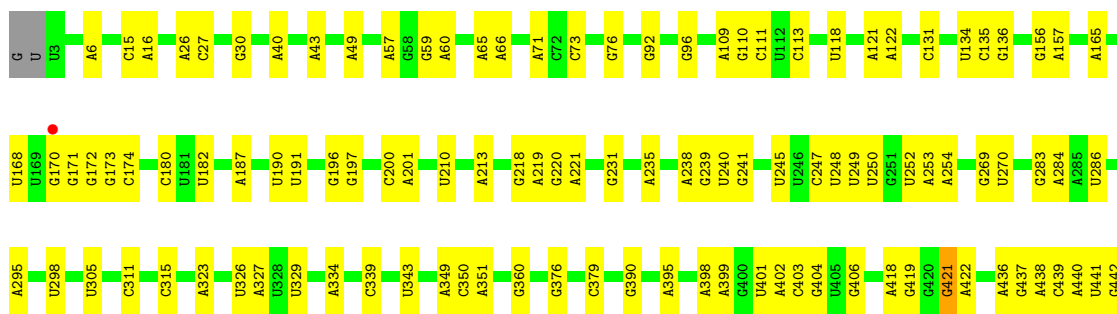

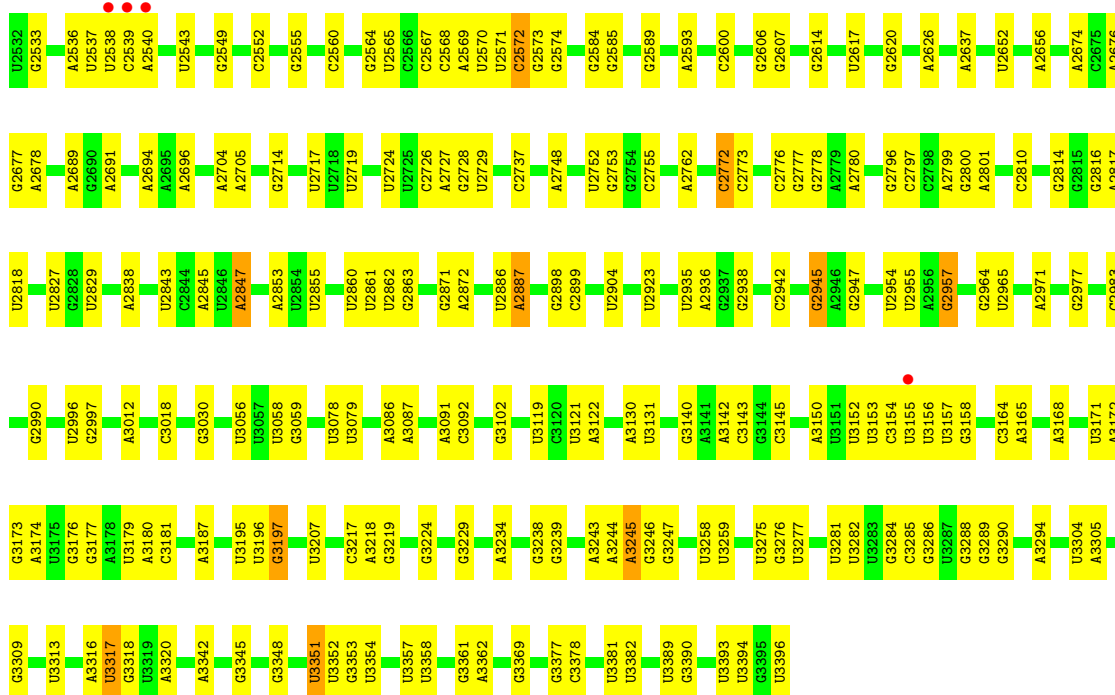

• Molecule 37: 5S ribosomal RNA

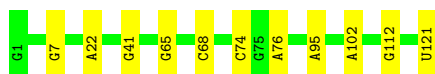
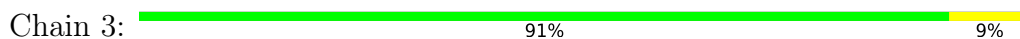

• Molecule 37: 5S ribosomal RNA

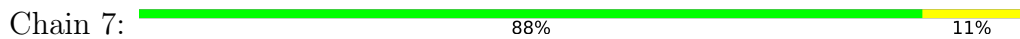

• Molecule 38: 5.8S ribosomal RNA

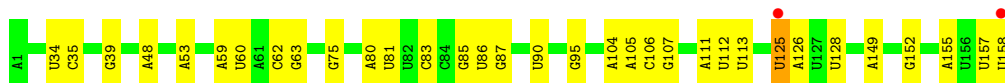
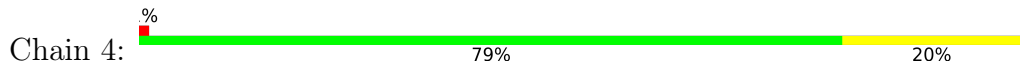

• Molecule 38: 5.8S ribosomal RNA

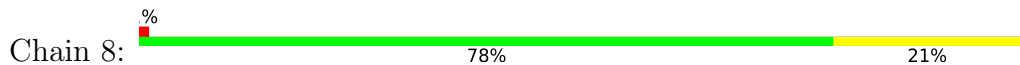

• Molecule 39: 60S ribosomal protein L2-A

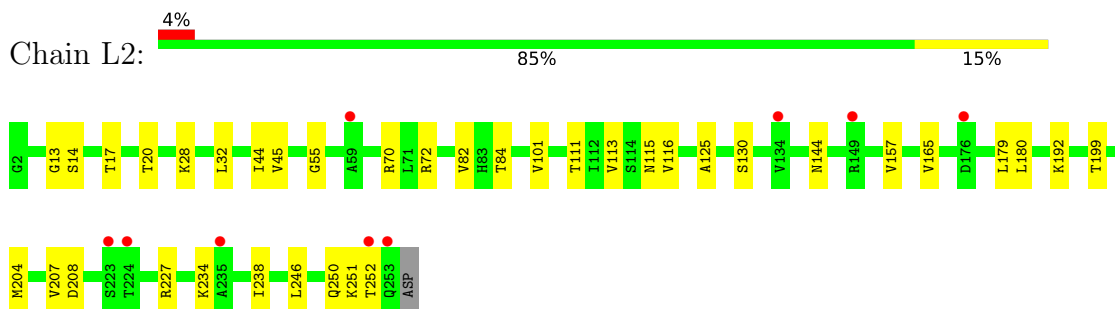

- Molecule 39: 60S ribosomal protein L2-A

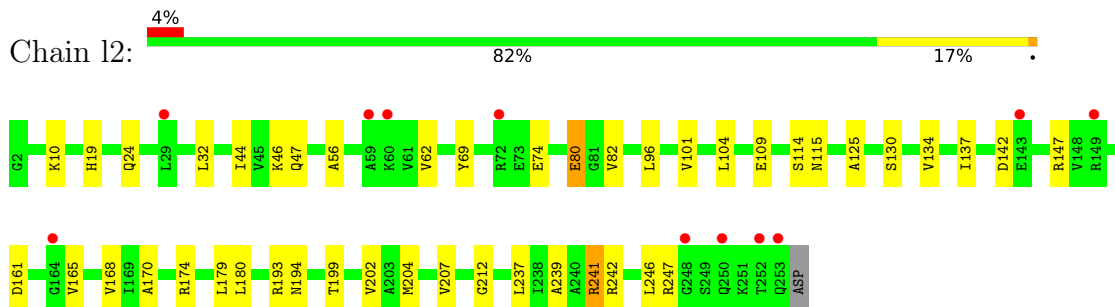

- Molecule 40: 60S ribosomal protein L3

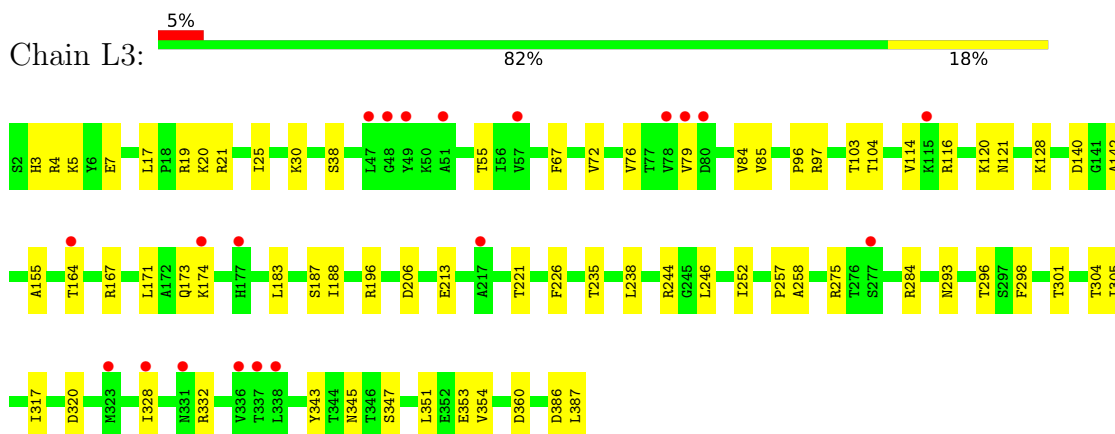

- Molecule 40: 60S ribosomal protein L3

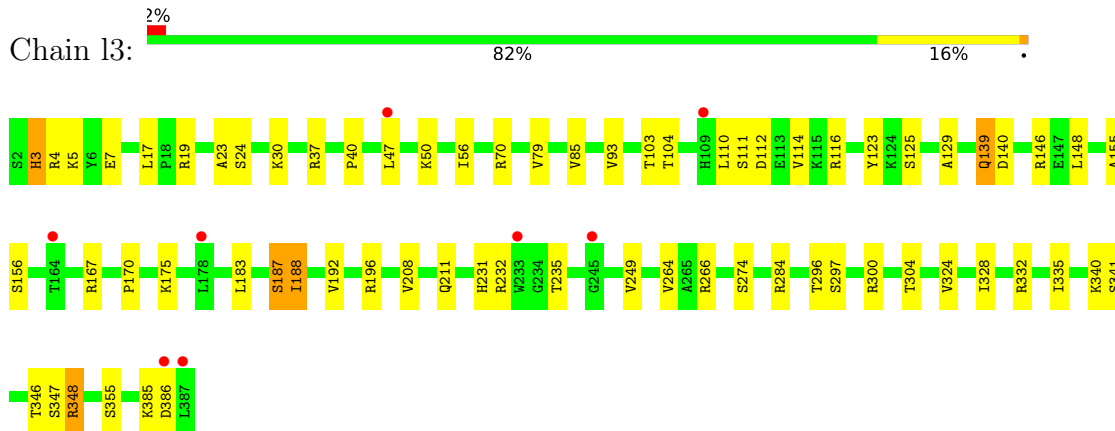

- Molecule 41: 60S ribosomal protein L4-A

Chain L4:  84% 16%

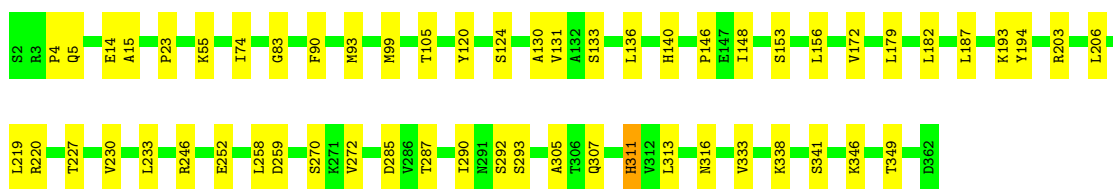

- Molecule 41: 60S ribosomal protein L4-A

Chain l4:  84% 15%

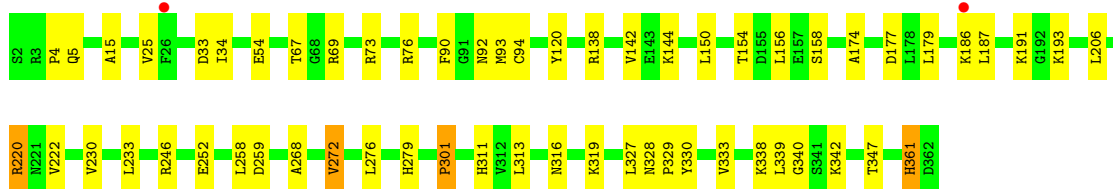

- Molecule 42: 60S ribosomal protein L5

Chain L5:  23% 83% 16%

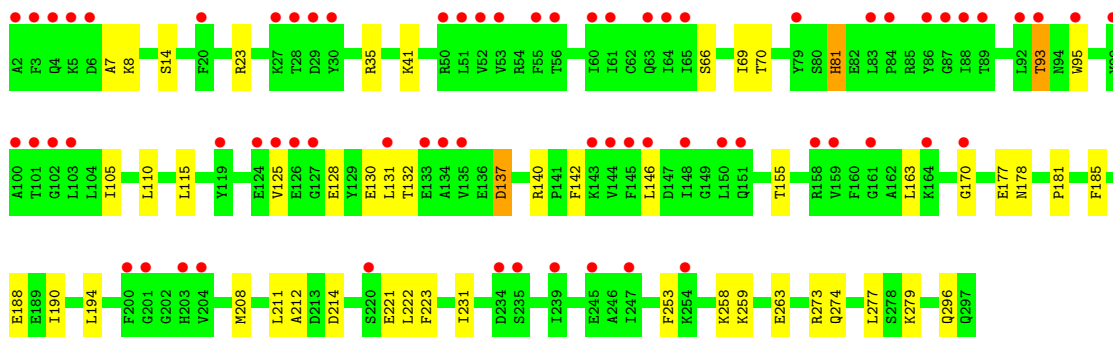

- Molecule 42: 60S ribosomal protein L5

Chain l5:  7% 83% 15%

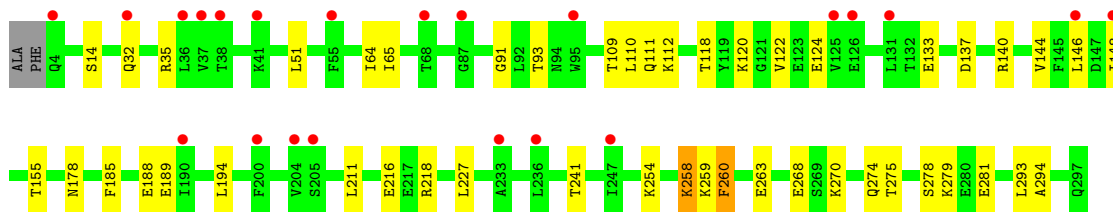

- Molecule 43: 60S ribosomal protein L6-A

Chain L6:  6% 78% 11% 11%

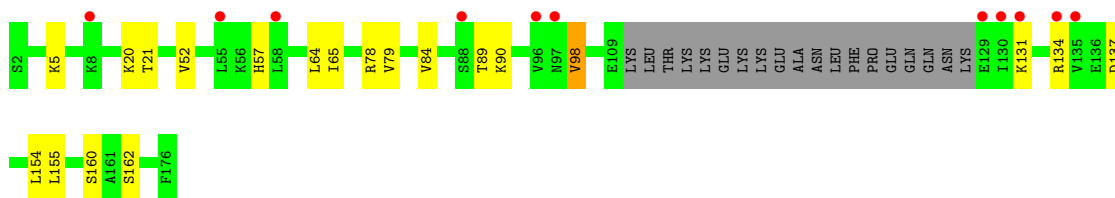

- Molecule 43: 60S ribosomal protein L6-A

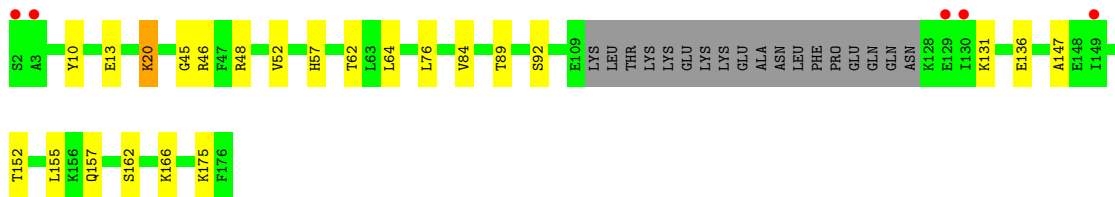
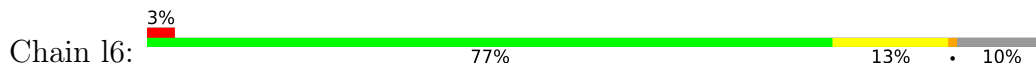

- Molecule 44: 60S ribosomal protein L7-A

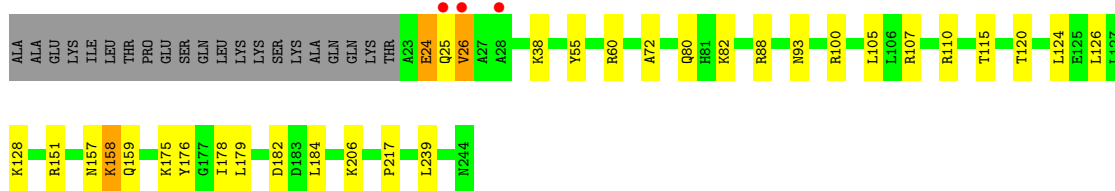
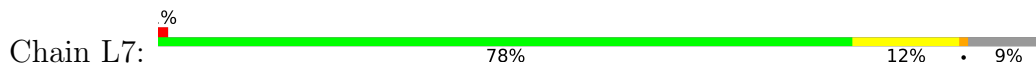

- Molecule 44: 60S ribosomal protein L7-A

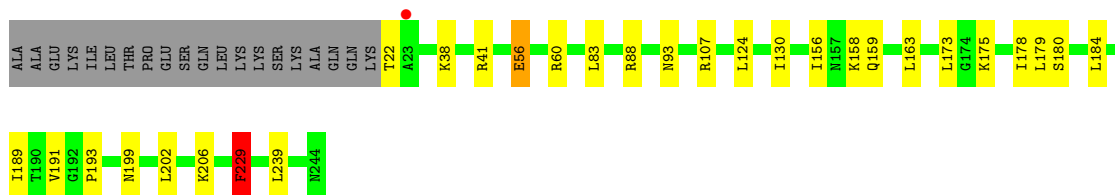
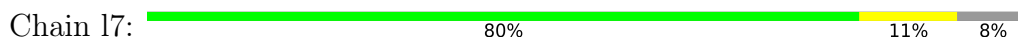

- Molecule 45: 60S ribosomal protein L8-A

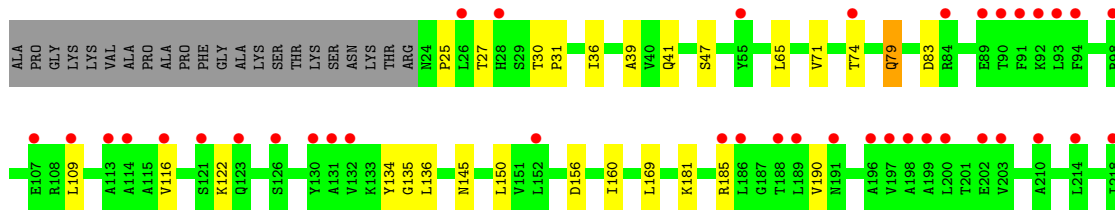
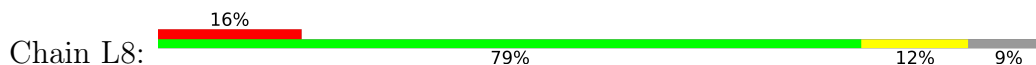

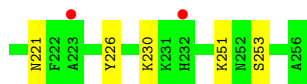

- Molecule 45: 60S ribosomal protein L8-A

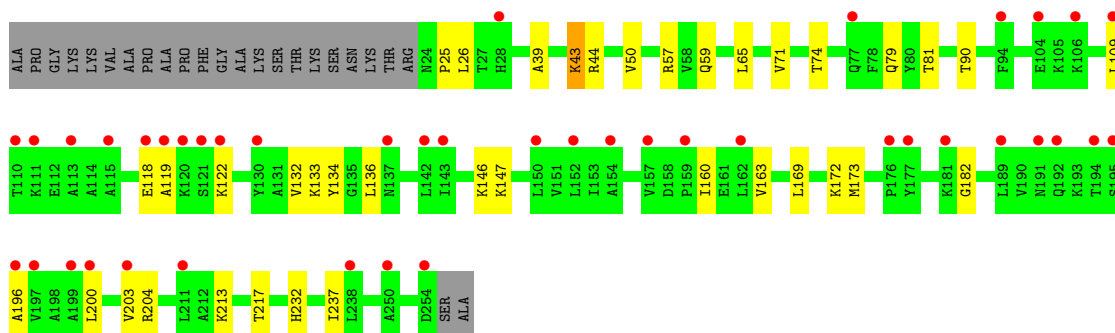
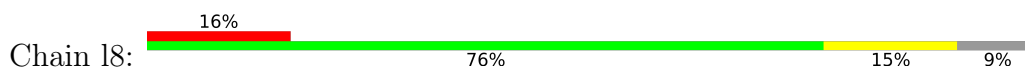

- Molecule 46: 60S ribosomal protein L9-A

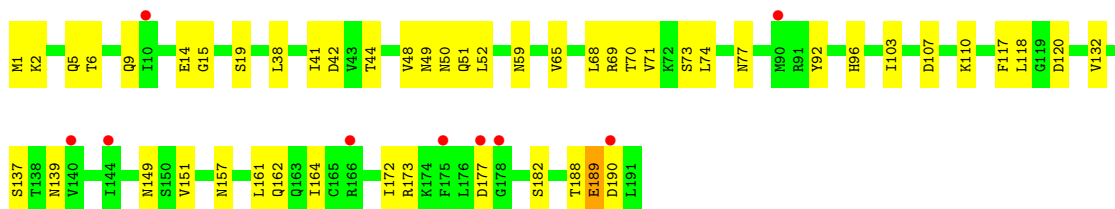
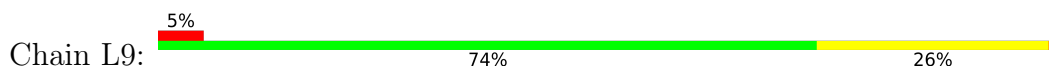

- Molecule 46: 60S ribosomal protein L9-A

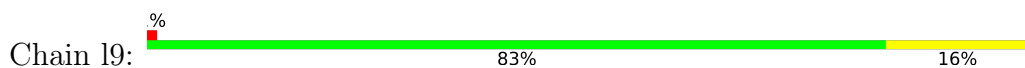

- Molecule 47: 60S ribosomal protein L10

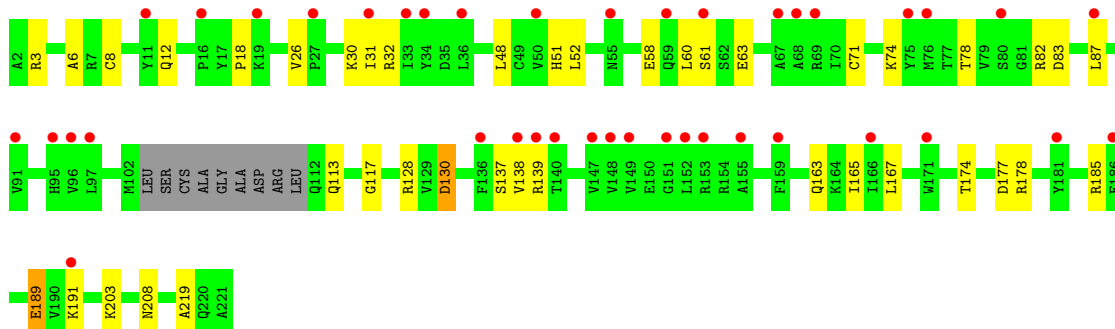
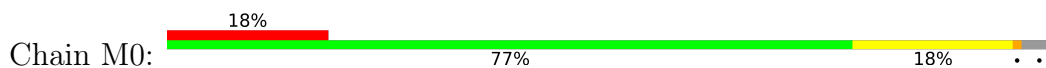

- Molecule 47: 60S ribosomal protein L10

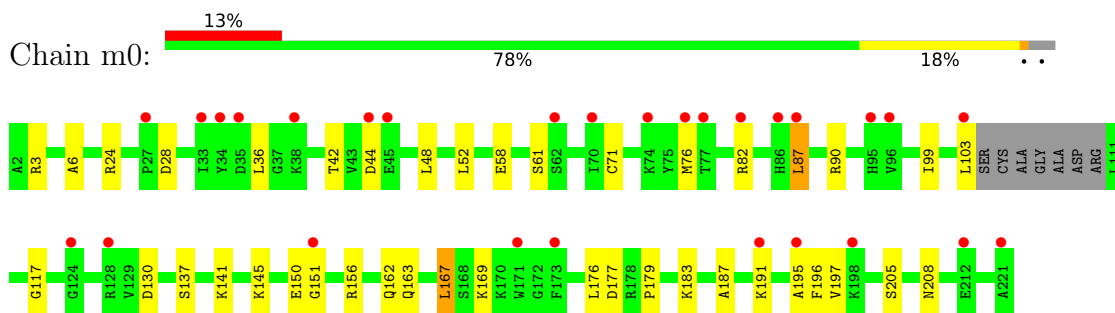

- Molecule 48: 60S ribosomal protein L11-B

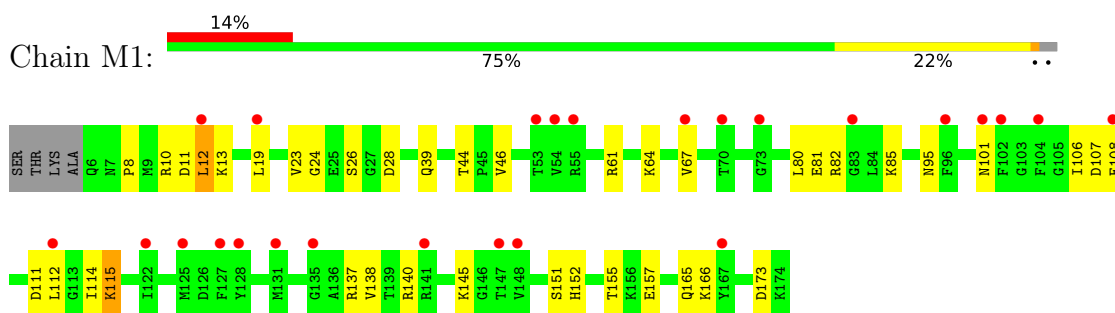

- Molecule 48: 60S ribosomal protein L11-B

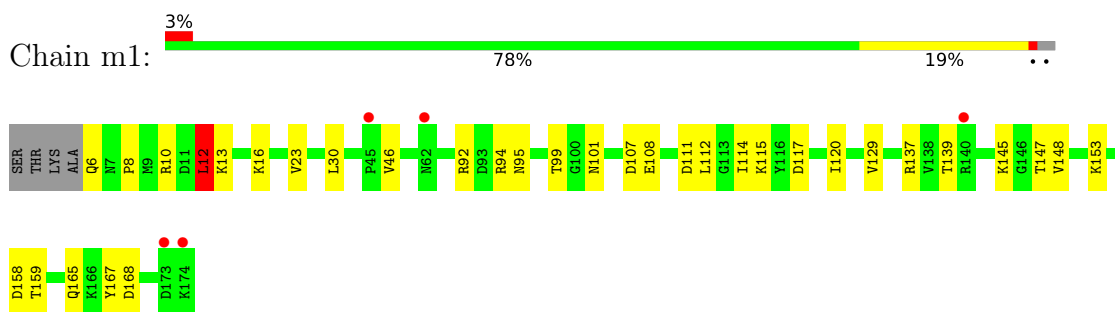

- Molecule 49: 60S ribosomal protein L13-A

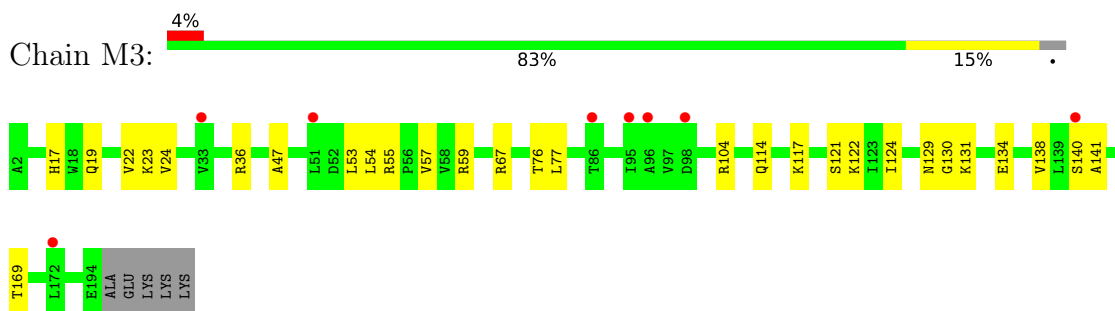

- Molecule 49: 60S ribosomal protein L13-A

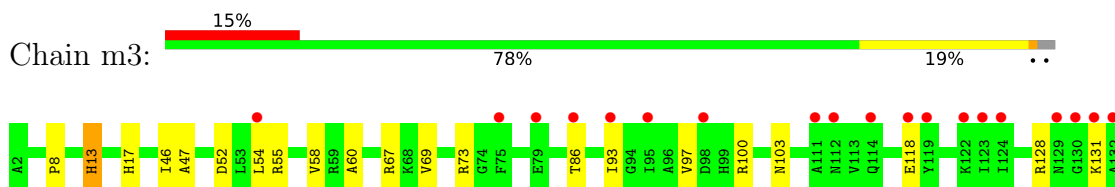



• Molecule 50: 60S ribosomal protein L14-A

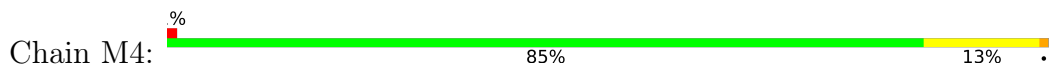

• Molecule 50: 60S ribosomal protein L14-A

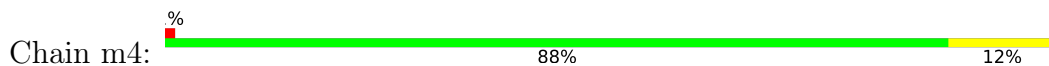

• Molecule 51: 60S ribosomal protein L15-A

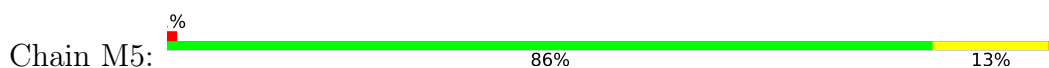

• Molecule 51: 60S ribosomal protein L15-A

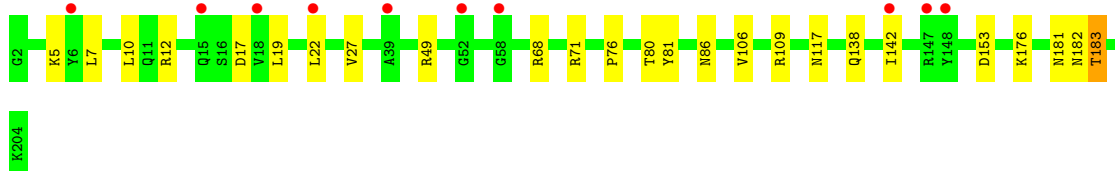
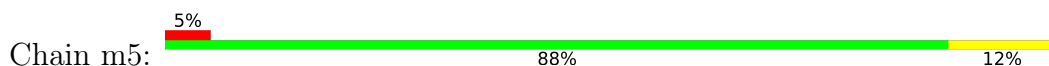

• Molecule 52: 60S ribosomal protein L16-A

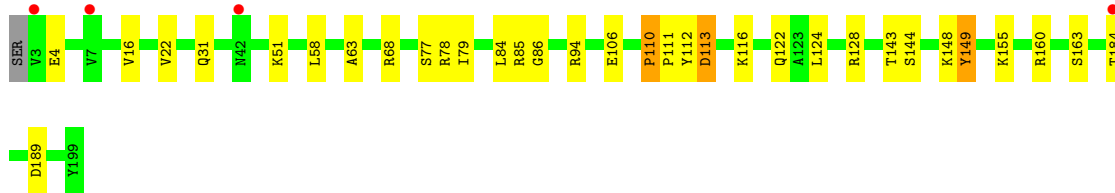
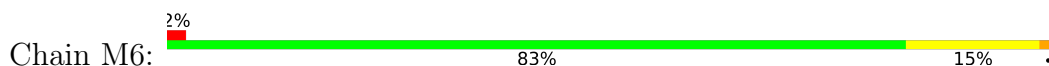

• Molecule 52: 60S ribosomal protein L16-A

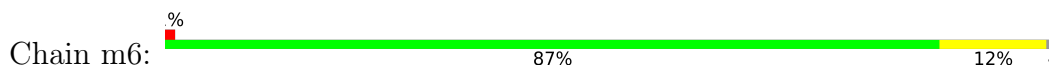



- Molecule 53: 60S ribosomal protein L17-A

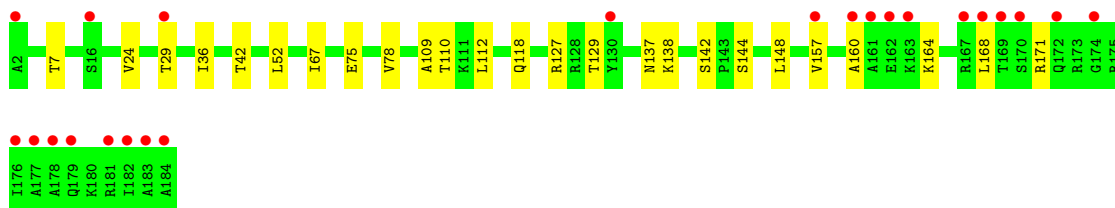
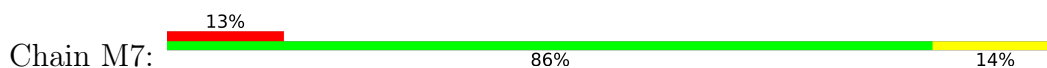

- Molecule 53: 60S ribosomal protein L17-A

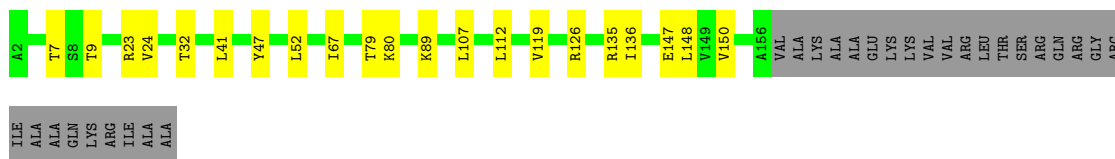
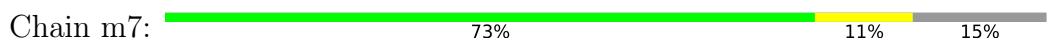

- Molecule 54: 60S ribosomal protein L18-A

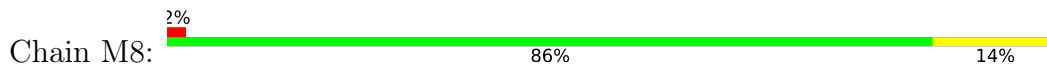

- Molecule 54: 60S ribosomal protein L18-A

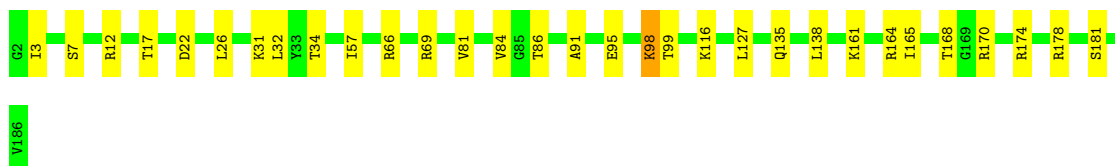
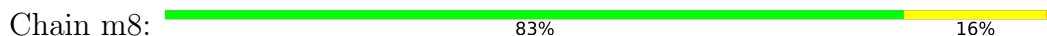

- Molecule 55: 60S ribosomal protein L19-A

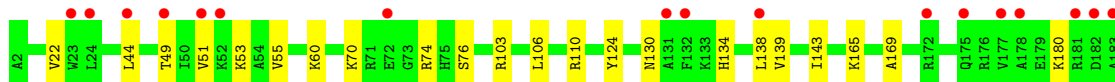
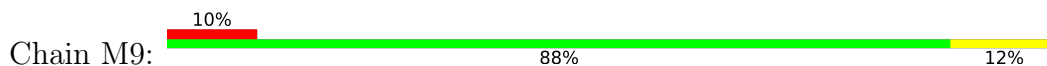

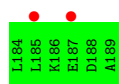

- Molecule 55: 60S ribosomal protein L19-A

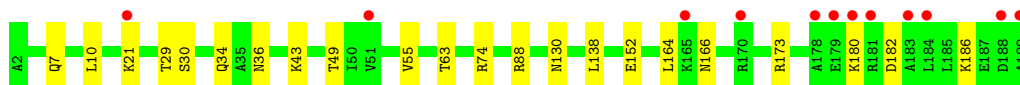
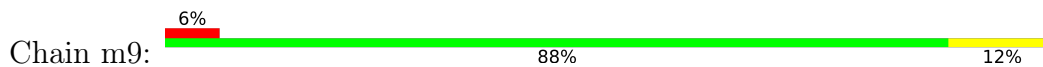

- Molecule 56: 60S ribosomal protein L20-A

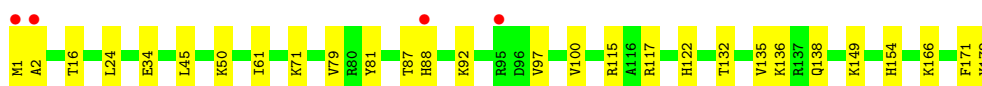
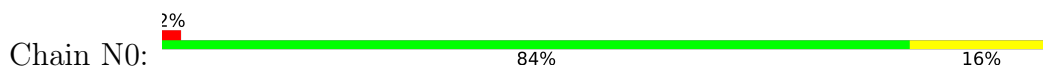

- Molecule 56: 60S ribosomal protein L20-A

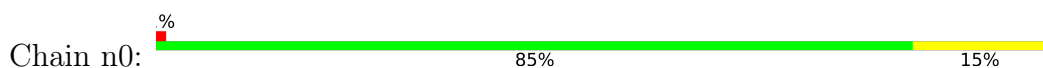

- Molecule 57: 60S ribosomal protein L21-A

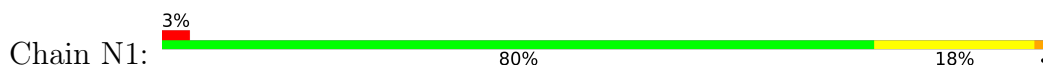

- Molecule 57: 60S ribosomal protein L21-A

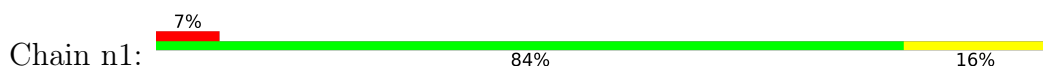

- Molecule 58: 60S ribosomal protein L22-A

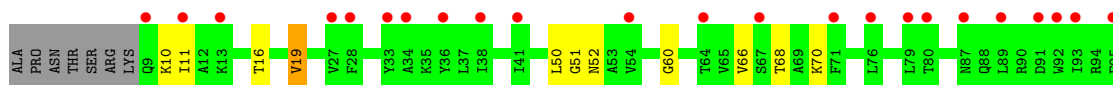
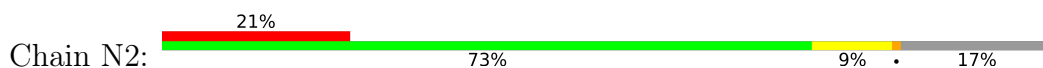

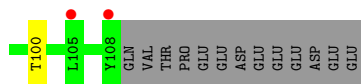

• Molecule 58: 60S ribosomal protein L22-A

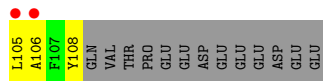
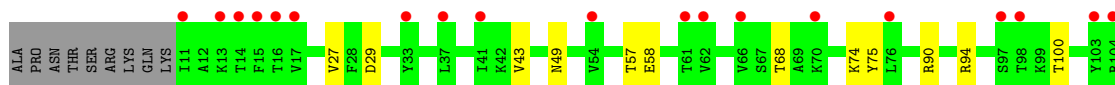

• Molecule 59: 60S ribosomal protein L23-A

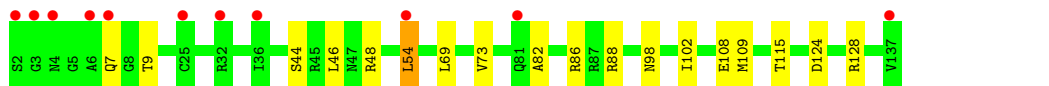
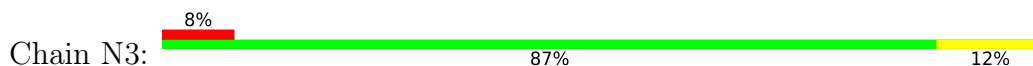

• Molecule 59: 60S ribosomal protein L23-A

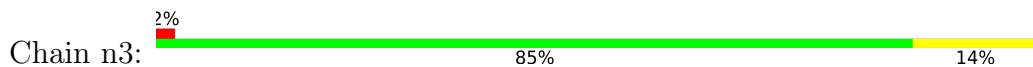

• Molecule 60: 60S ribosomal protein L24-A

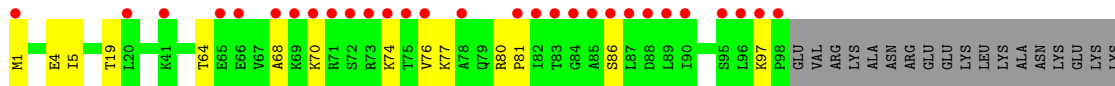

• Molecule 60: 60S ribosomal protein L24-A

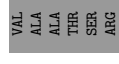
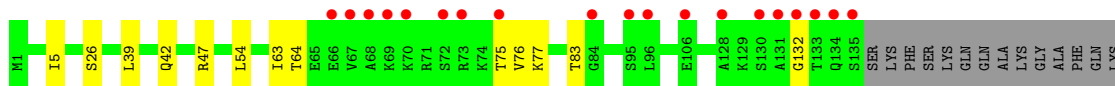
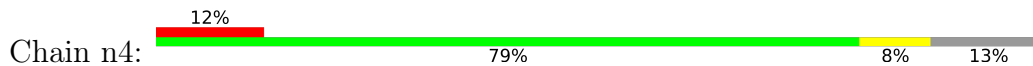

• Molecule 61: 60S ribosomal protein L25



- Molecule 61: 60S ribosomal protein L25

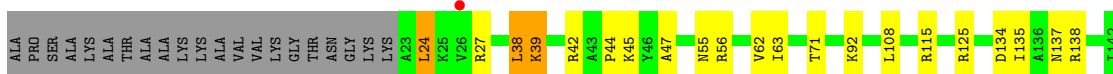

- Molecule 62: 60S ribosomal protein L26-A

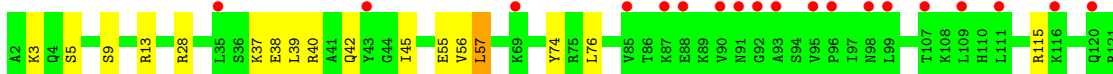
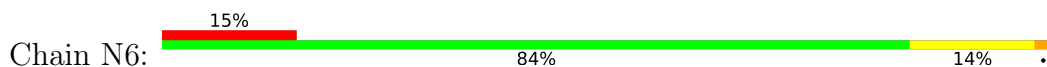

- Molecule 62: 60S ribosomal protein L26-A

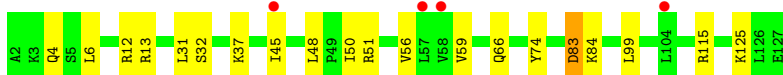
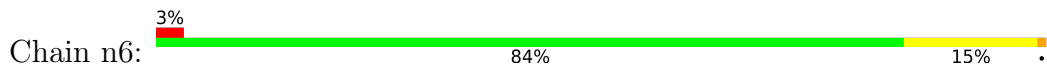

- Molecule 63: 60S ribosomal protein L27-A

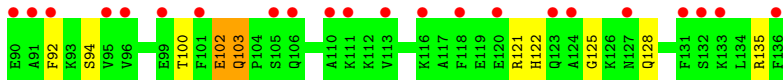
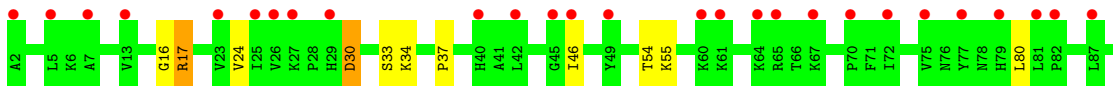
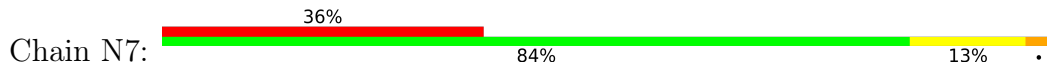

- Molecule 63: 60S ribosomal protein L27-A

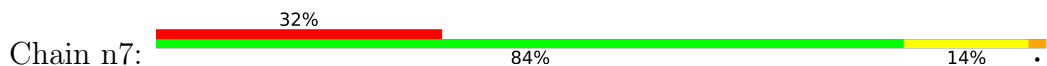

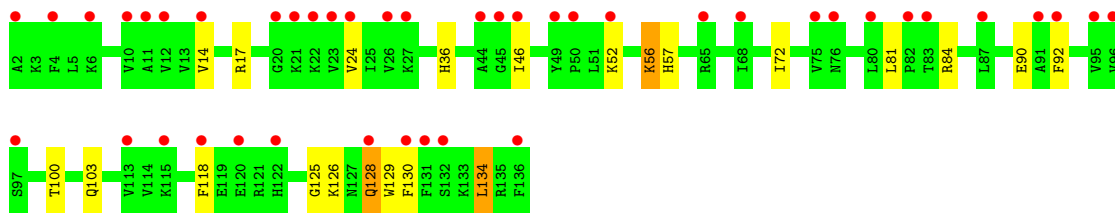

- Molecule 64: 60S ribosomal protein L28

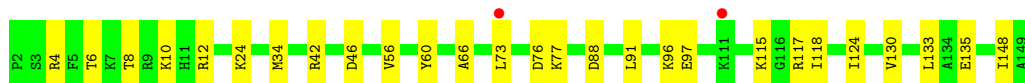
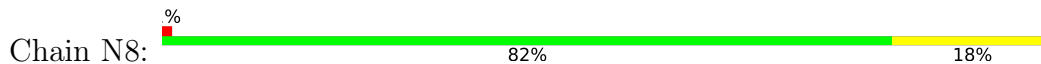

- Molecule 64: 60S ribosomal protein L28

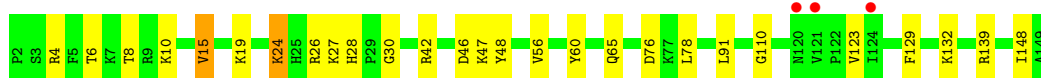
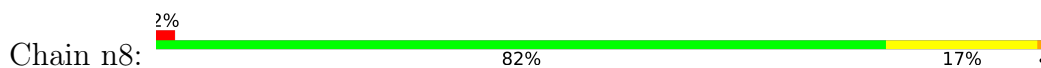

- Molecule 65: 60S ribosomal protein L29

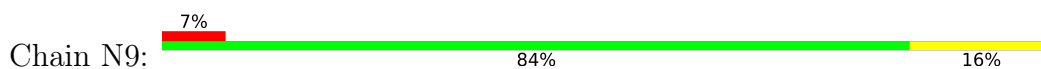

- Molecule 65: 60S ribosomal protein L29

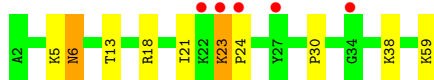
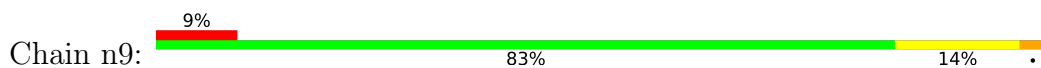

- Molecule 66: 60S ribosomal protein L30

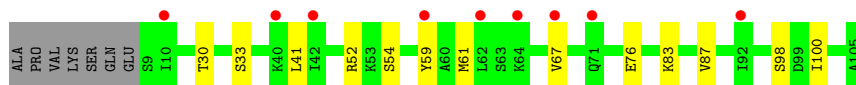
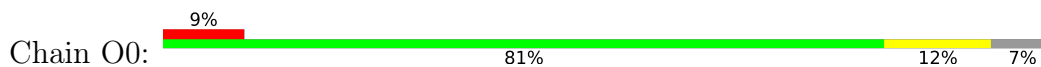

- Molecule 66: 60S ribosomal protein L30

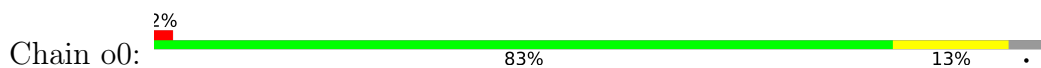



- Molecule 67: 60S ribosomal protein L31-A

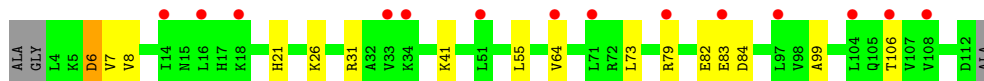
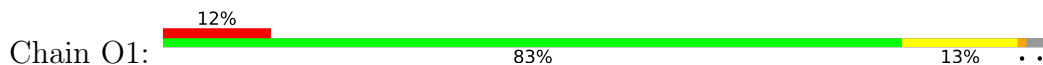

- Molecule 67: 60S ribosomal protein L31-A

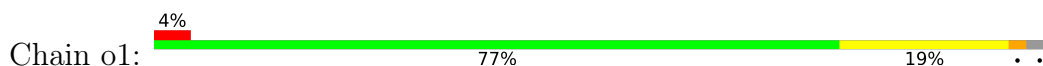

- Molecule 68: 60S ribosomal protein L32

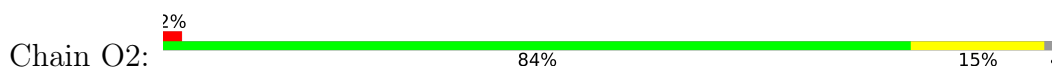

- Molecule 68: 60S ribosomal protein L32

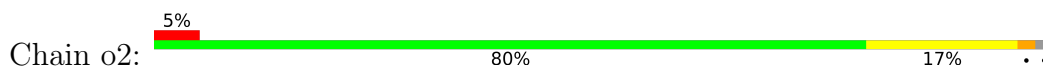

- Molecule 69: 60S ribosomal protein L33-A

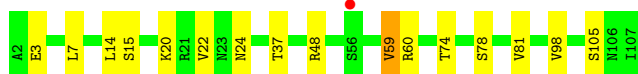
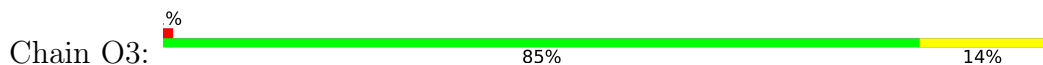

- Molecule 69: 60S ribosomal protein L33-A

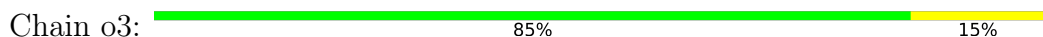

- Molecule 70: 60S ribosomal protein L34-A

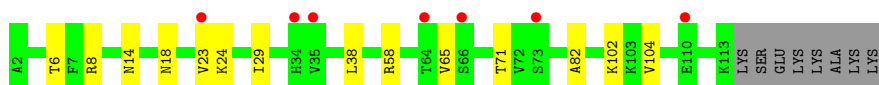
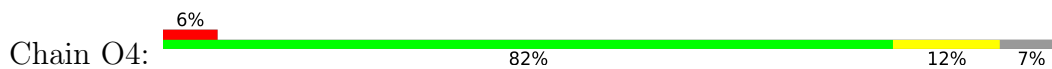

- Molecule 70: 60S ribosomal protein L34-A

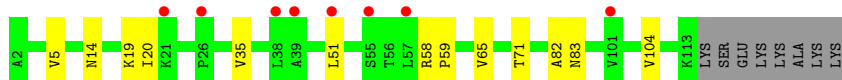
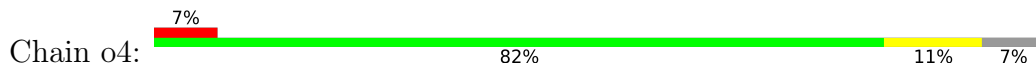

- Molecule 71: 60S ribosomal protein L35-A

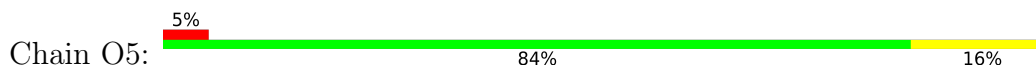

- Molecule 71: 60S ribosomal protein L35-A

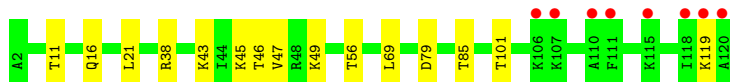
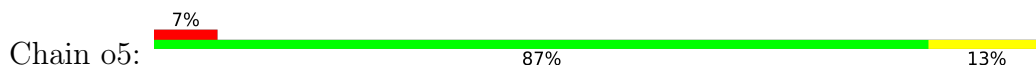

- Molecule 72: 60S ribosomal protein L36-A

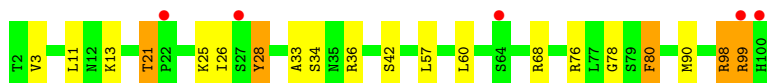
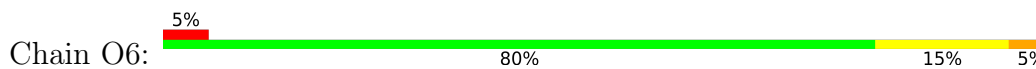

- Molecule 72: 60S ribosomal protein L36-A

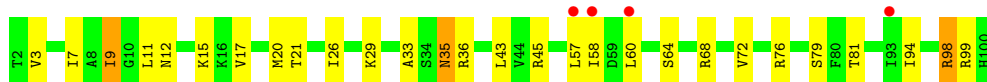
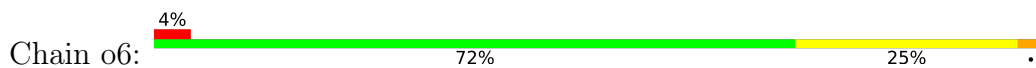

- Molecule 73: 60S ribosomal protein L37-A

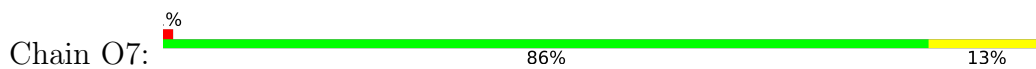

- Molecule 73: 60S ribosomal protein L37-A

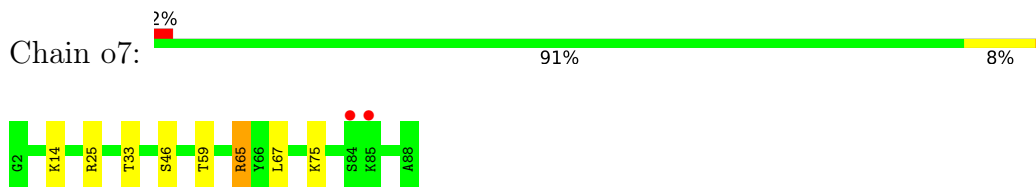

- Molecule 74: 60S ribosomal protein L38

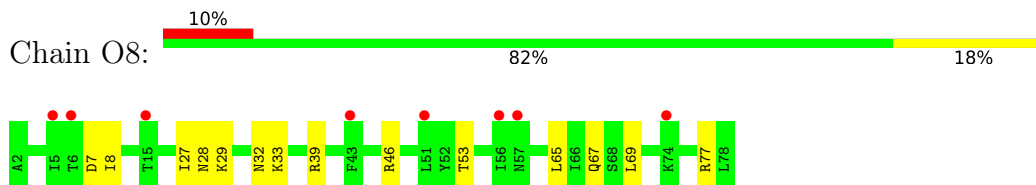

- Molecule 74: 60S ribosomal protein L38

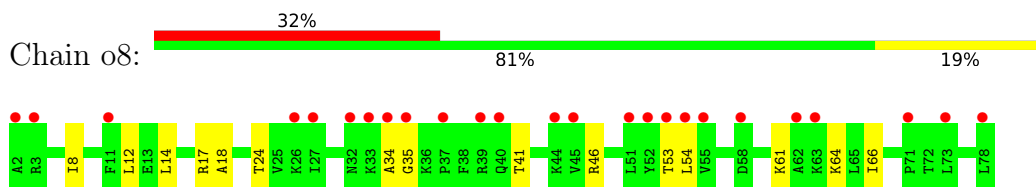

- Molecule 75: 60S ribosomal protein L39

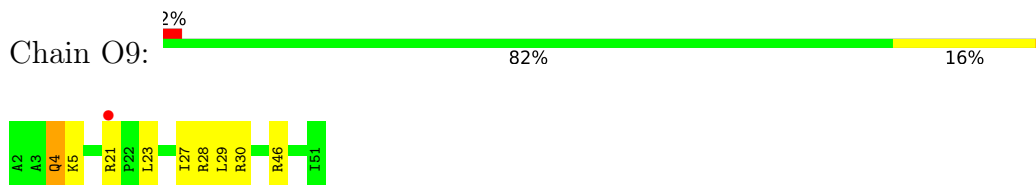

- Molecule 75: 60S ribosomal protein L39

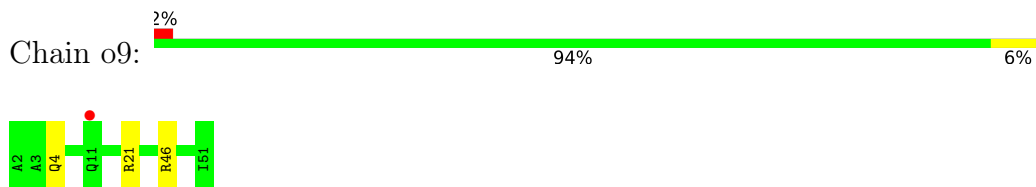

- Molecule 76: Ubiquitin-60S ribosomal protein L40

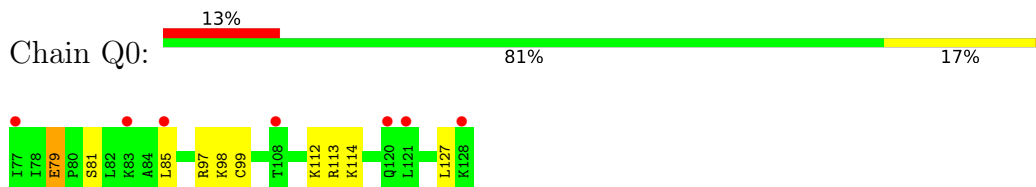

- Molecule 76: Ubiquitin-60S ribosomal protein L40

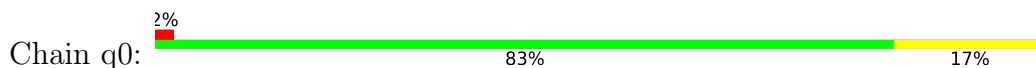

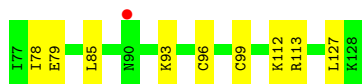

- Molecule 77: 60S ribosomal protein L41-A

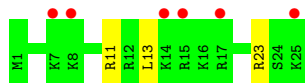
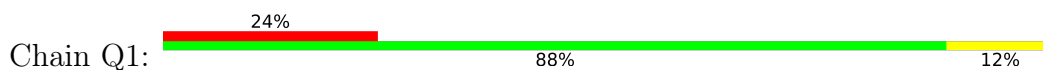

- Molecule 77: 60S ribosomal protein L41-A

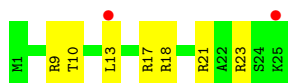
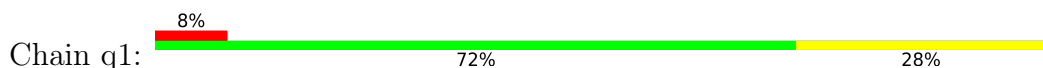

- Molecule 78: 60S ribosomal protein L42-A

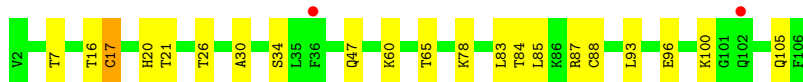
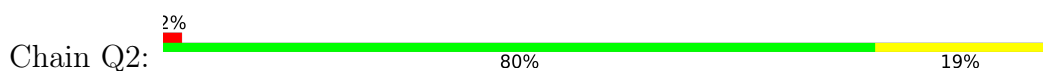

- Molecule 78: 60S ribosomal protein L42-A

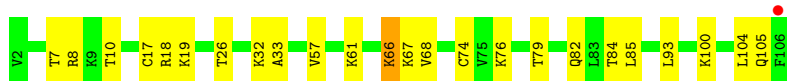
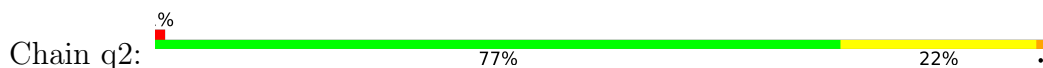

- Molecule 79: 60S ribosomal protein L43-A

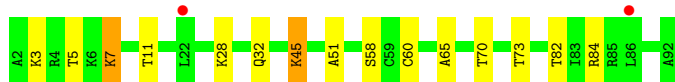
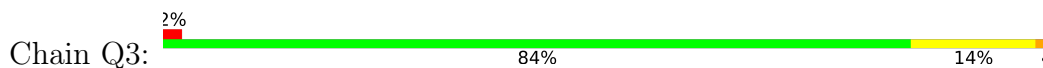

- Molecule 79: 60S ribosomal protein L43-A

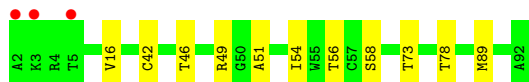
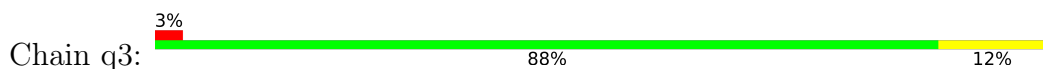

- Molecule 80: 60S ribosomal protein L12-A (uL11)

Chain m2: 91% 9%



- Molecule 81: 60S acidic ribosomal protein P0

Chain p0: 10% 41% 5% 54%

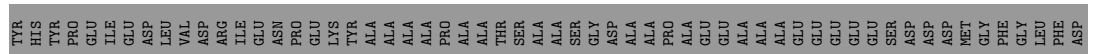
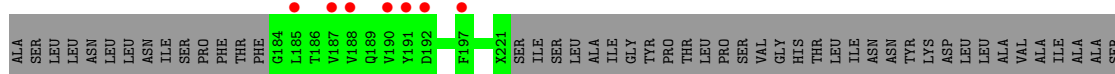
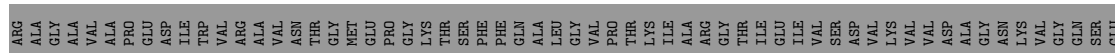
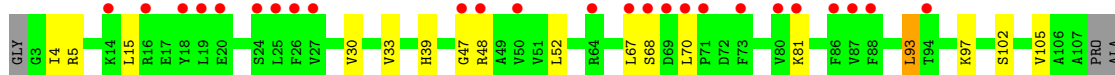

- Molecule 82: 60S ribosomal protein P1 alpha/P2 beta

Chain p1: 100%

There are no outlier residues recorded for this chain.

- Molecule 82: 60S ribosomal protein P1 alpha/P2 beta

Chain p2: 98% .



- Molecule 83: Eukaryotic translation initiation factor 5A-1

Chain f: 59% 73% 19% 6%

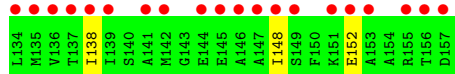
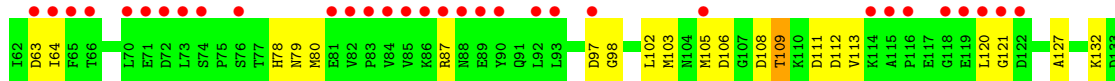
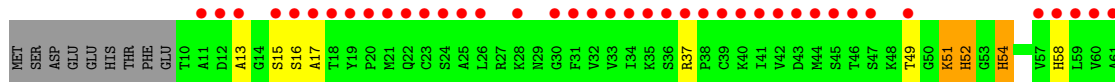

- Molecule 84: CH-CH-8AN-PRO-PRO

Chain B:  40% 60%

C74	C75	A76	P77	P78
-----	-----	-----	-----	-----

- Molecule 84: CH-CH-8AN-PRO-PRO

Chain C:  40% 60%

C74	C75	A76	P77	P78
-----	-----	-----	-----	-----

4 Data and refinement statistics

Property	Value	Source
Space group	P 1 21 1	Depositor
Cell constants a, b, c, α , β , γ	435.58Å 287.33Å 303.82Å 90.00° 98.95° 90.00°	Depositor
Resolution (Å)	99.53 – 3.30 99.53 – 3.30	Depositor EDS
% Data completeness (in resolution range)	100.0 (99.53-3.30) 99.9 (99.53-3.30)	Depositor EDS
R_{merge}	0.59	Depositor
R_{sym}	(Not available)	Depositor
$\langle I/\sigma(I) \rangle$ ¹	1.34 (at 3.33Å)	Xtrriage
Refinement program	PHENIX	Depositor
R, R_{free}	0.251 , 0.310 0.255 , (Not available)	Depositor DCC
R_{free} test set	No test flags present.	wwPDB-VP
Wilson B-factor (Å ²)	85.9	Xtrriage
Anisotropy	0.176	Xtrriage
Bulk solvent k_{sol} (e/Å ³), B_{sol} (Å ²)	0.32 , 74.2	EDS
L-test for twinning ²	$\langle L \rangle = 0.46$, $\langle L^2 \rangle = 0.28$	Xtrriage
Estimated twinning fraction	No twinning to report.	Xtrriage
F_o, F_c correlation	0.88	EDS
Total number of atoms	404292	wwPDB-VP
Average B, all atoms (Å ²)	79.0	wwPDB-VP

Xtrriage's analysis on translational NCS is as follows: *The largest off-origin peak in the Patterson function is 1.50% of the height of the origin peak. No significant pseudotranslation is detected.*

¹Intensities estimated from amplitudes.

²Theoretical values of $\langle |L| \rangle$, $\langle L^2 \rangle$ for acentric reflections are 0.5, 0.333 respectively for untwinned datasets, and 0.375, 0.2 for perfectly twinned datasets.

5 Model quality i

5.1 Standard geometry i

Bond lengths and bond angles in the following residue types are not validated in this section: 8AN, SPS, OHX, MG, ZN, CH

The Z score for a bond length (or angle) is the number of standard deviations the observed value is removed from the expected value. A bond length (or angle) with $|Z| > 5$ is considered an outlier worth inspection. RMSZ is the root-mean-square of all Z scores of the bond lengths (or angles).

Mol	Chain	Bond lengths		Bond angles	
		RMSZ	# Z >5	RMSZ	# Z >5
1	2	0.36	0/42467	0.89	42/66169 (0.1%)
1	6	0.43	0/42790	0.93	50/66673 (0.1%)
2	S0	0.28	0/1617	0.50	0/2215
2	s0	0.29	0/1623	0.51	0/2222
3	S1	0.26	0/1735	0.50	0/2335
3	s1	0.32	0/1748	0.53	0/2352
4	S2	0.30	0/1665	0.52	0/2263
4	s2	0.33	0/1665	0.55	1/2263 (0.0%)
5	S3	0.29	0/1759	0.47	0/2368
5	s3	0.27	0/1759	0.47	0/2368
6	S4	0.29	0/2109	0.53	0/2839
6	s4	0.34	0/2109	0.55	0/2839
7	S5	0.27	0/1629	0.50	0/2202
7	s5	0.28	0/1629	0.48	0/2202
8	S6	0.29	0/1823	0.47	0/2439
8	s6	0.33	0/1779	0.53	0/2379
9	S7	0.28	0/1506	0.53	1/2028 (0.0%)
9	s7	0.29	0/1516	0.52	0/2043
10	S8	0.30	0/1514	0.51	0/2021
10	s8	0.34	0/1514	0.52	0/2021
11	S9	0.29	0/1519	0.48	0/2035
11	s9	0.31	0/1519	0.50	0/2035
12	C0	0.28	0/725	0.44	0/978
12	c0	0.27	0/713	0.51	1/961 (0.1%)
13	C1	0.31	0/1185	0.50	0/1598
13	c1	0.36	0/1185	0.55	0/1598
14	C2	0.26	0/819	0.49	0/1109
14	c2	0.22	0/819	0.47	0/1109
15	C3	0.31	0/1215	0.52	1/1638 (0.1%)
15	c3	0.33	0/1215	0.51	0/1638
16	C4	0.26	0/901	0.51	0/1217
16	c4	0.30	0/960	0.54	0/1290

Mol	Chain	Bond lengths		Bond angles	
		RMSZ	# Z >5	RMSZ	# Z >5
17	C5	0.31	0/988	0.54	0/1327
17	c5	0.29	0/1030	0.52	0/1384
18	C6	0.29	0/1125	0.54	2/1510 (0.1%)
18	c6	0.29	0/1131	0.51	0/1518
19	C7	0.30	0/935	0.52	0/1254
19	c7	0.27	0/914	0.50	0/1224
20	C8	0.30	0/1211	0.51	0/1628
20	c8	0.28	0/1211	0.49	0/1628
21	C9	0.29	0/1130	0.48	0/1517
21	c9	0.29	0/1130	0.47	0/1517
22	D0	0.30	0/865	0.52	0/1169
22	d0	0.29	0/892	0.49	0/1205
23	D1	0.29	0/693	0.49	0/935
23	d1	0.31	0/693	0.50	0/935
24	D2	0.30	0/1038	0.55	1/1395 (0.1%)
24	d2	0.35	0/1038	0.56	1/1395 (0.1%)
25	D3	0.35	0/1139	0.55	0/1518
25	d3	0.38	0/1139	0.57	0/1518
26	D4	0.29	0/1087	0.47	0/1449
26	d4	0.31	0/1087	0.51	0/1449
27	D5	0.26	0/571	0.55	0/768
27	d5	0.26	0/566	0.47	0/761
28	D6	0.29	0/782	0.53	0/1047
28	d6	0.34	0/782	0.53	0/1047
29	D7	0.29	0/620	0.51	0/838
29	d7	0.28	0/620	0.49	0/838
30	D8	0.27	0/499	0.47	0/670
30	d8	0.28	0/499	0.49	0/670
31	D9	0.32	0/452	0.55	1/600 (0.2%)
31	d9	0.33	0/452	0.50	0/600
32	E0	0.28	0/483	0.48	0/643
32	e0	0.32	0/499	0.54	0/665
33	E1	0.29	0/577	0.56	0/770
33	e1	0.29	0/619	0.58	0/822
34	SR	0.26	0/2490	0.49	0/3389
34	sR	0.25	0/2495	0.44	0/3395
35	SM	0.31	0/925	0.54	1/1240 (0.1%)
35	sM	0.31	0/480	0.53	0/642
36	1	0.56	0/75394	1.03	115/117545 (0.1%)
36	5	0.59	2/75865 (0.0%)	1.05	143/118275 (0.1%)
37	3	0.46	0/2883	0.91	0/4491
37	7	0.55	0/2883	1.00	2/4491 (0.0%)
38	4	0.53	0/3746	1.00	5/5832 (0.1%)

Mol	Chain	Bond lengths		Bond angles	
		RMSZ	# Z >5	RMSZ	# Z >5
38	8	0.52	0/3746	0.97	2/5832 (0.0%)
39	L2	0.37	0/1948	0.57	0/2617
39	l2	0.40	0/1946	0.62	0/2614
40	L3	0.39	0/3146	0.56	0/4228
40	l3	0.45	0/3146	0.58	0/4228
41	L4	0.41	0/2800	0.61	0/3790
41	l4	0.41	1/2800 (0.0%)	0.63	2/3790 (0.1%)
42	L5	0.35	0/2425	0.53	0/3271
42	l5	0.42	0/2408	0.55	0/3248
43	L6	0.39	0/1260	0.55	0/1694
43	l6	0.41	0/1269	0.57	0/1705
44	L7	0.42	0/1821	0.59	0/2451
44	l7	0.43	0/1828	0.62	2/2461 (0.1%)
45	L8	0.31	0/1836	0.53	0/2481
45	l8	0.32	0/1796	0.51	0/2431
46	L9	0.36	0/1539	0.56	0/2073
46	l9	0.40	0/1539	0.57	0/2073
47	M0	0.40	1/1741 (0.1%)	0.55	0/2335
47	m0	0.43	0/1758	0.61	2/2358 (0.1%)
48	M1	0.31	0/1374	0.50	0/1842
48	m1	0.38	0/1374	0.59	1/1842 (0.1%)
49	M3	0.40	0/1568	0.59	0/2106
49	m3	0.37	0/1573	0.57	0/2113
50	M4	0.40	0/1068	0.54	0/1438
50	m4	0.41	0/1074	0.57	0/1446
51	M5	0.38	0/1757	0.56	0/2354
51	m5	0.36	0/1757	0.55	0/2354
52	M6	0.44	0/1585	0.59	0/2128
52	m6	0.50	0/1585	0.61	0/2128
53	M7	0.41	0/1443	0.58	0/1944
53	m7	0.44	0/1250	0.59	0/1683
54	M8	0.39	0/1465	0.60	0/1965
54	m8	0.39	0/1465	0.60	0/1965
55	M9	0.31	0/1538	0.49	0/2050
55	m9	0.34	0/1538	0.51	0/2050
56	N0	0.39	0/1481	0.56	0/1990
56	n0	0.44	0/1481	0.59	0/1990
57	N1	0.40	0/1300	0.56	1/1743 (0.1%)
57	n1	0.43	0/1300	0.55	0/1743
58	N2	0.30	0/812	0.48	0/1099
58	n2	0.32	0/794	0.52	0/1076
59	N3	0.39	0/1018	0.57	0/1369
59	n3	0.45	0/1018	0.61	0/1369

Mol	Chain	Bond lengths		Bond angles	
		RMSZ	# Z >5	RMSZ	# Z >5
60	N4	0.31	0/712	0.50	0/958
60	n4	0.35	0/1052	0.51	0/1398
61	N5	0.33	0/979	0.55	0/1321
61	n5	0.36	0/974	0.57	0/1314
62	N6	0.35	0/1004	0.62	2/1341 (0.1%)
62	n6	0.35	0/1004	0.57	0/1341
63	N7	0.30	0/1118	0.50	0/1497
63	n7	0.31	0/1118	0.51	0/1497
64	N8	0.41	0/1204	0.62	0/1612
64	n8	0.40	0/1204	0.61	0/1612
65	N9	0.38	0/473	0.60	0/629
65	n9	0.43	0/473	0.67	0/629
66	O0	0.30	0/751	0.47	0/1008
66	o0	0.31	0/775	0.52	0/1040
67	O1	0.34	0/890	0.52	0/1196
67	o1	0.41	0/897	0.60	0/1205
68	O2	0.43	0/1041	0.63	0/1394
68	o2	0.44	0/1041	0.62	0/1394
69	O3	0.48	0/868	0.56	0/1168
69	o3	0.48	0/868	0.58	0/1168
70	O4	0.34	0/890	0.54	0/1189
70	o4	0.34	0/890	0.58	0/1189
71	O5	0.37	0/978	0.57	0/1301
71	o5	0.34	0/974	0.53	0/1297
72	O6	0.37	0/778	0.60	0/1034
72	o6	0.34	0/777	0.54	0/1033
73	O7	0.42	0/696	0.61	0/923
73	o7	0.40	0/696	0.59	0/923
74	O8	0.30	0/618	0.47	0/826
74	o8	0.31	0/614	0.54	0/822
75	O9	0.39	0/443	0.58	0/588
75	o9	0.39	0/443	0.53	0/588
76	Q0	0.43	0/423	0.60	0/562
76	q0	0.45	0/423	0.55	0/562
77	Q1	0.36	0/234	0.59	0/300
77	q1	0.43	0/234	0.62	0/300
78	Q2	0.53	1/860 (0.1%)	0.63	0/1136
78	q2	0.52	1/860 (0.1%)	0.63	1/1136 (0.1%)
79	Q3	0.37	0/701	0.59	0/934
79	q3	0.43	0/701	0.56	0/934
81	p0	0.27	0/977	0.48	0/1313
83	f	0.34	0/1131	0.58	0/1522
84	B	0.31	0/15	0.54	0/20

Mol	Chain	Bond lengths		Bond angles	
		RMSZ	# Z >5	RMSZ	# Z >5
84	C	0.41	0/15	0.80	0/20
All	All	0.46	6/431576 (0.0%)	0.85	380/633602 (0.1%)

Chiral center outliers are detected by calculating the chiral volume of a chiral center and verifying if the center is modelled as a planar moiety or with the opposite hand. A planarity outlier is detected by checking planarity of atoms in a peptide group, atoms in a mainchain group or atoms of a sidechain that are expected to be planar.

Mol	Chain	#Chirality outliers	#Planarity outliers
18	c6	0	1
19	C7	0	1
27	D5	0	1
39	l2	0	1
44	L7	0	1
52	M6	0	1
64	n8	0	1
65	N9	0	1
65	n9	0	1
83	f	0	1
All	All	0	10

The worst 5 of 6 bond length outliers are listed below:

Mol	Chain	Res	Type	Atoms	Z	Observed(Å)	Ideal(Å)
78	q2	17	CYS	CB-SG	8.77	1.97	1.82
78	Q2	17	CYS	CB-SG	7.99	1.95	1.82
36	5	1152	G	N9-C4	-5.86	1.33	1.38
36	5	942	U	C4-O4	5.25	1.27	1.23
47	M0	8	CYS	CB-SG	-5.03	1.73	1.81

The worst 5 of 380 bond angle outliers are listed below:

Mol	Chain	Res	Type	Atoms	Z	Observed(°)	Ideal(°)
36	5	1152	G	N3-C4-N9	-11.60	119.04	126.00
36	5	1152	G	N3-C4-C5	11.31	134.25	128.60
36	5	2726	C	C6-N1-C2	-9.68	116.43	120.30
36	5	1152	G	C2-N3-C4	-9.61	107.10	111.90
36	1	406	G	O4'-C1'-N9	9.54	115.83	108.20

There are no chirality outliers.

5 of 10 planarity outliers are listed below:

Mol	Chain	Res	Type	Group
19	C7	85	VAL	Peptide
27	D5	94	LYS	Peptide
44	L7	157	ASN	Peptide
52	M6	110	PRO	Peptide
65	N9	20	GLY	Peptide

5.2 Too-close contacts [i](#)

Due to software issues we are unable to calculate clashes - this section is therefore empty.

5.3 Torsion angles [i](#)

5.3.1 Protein backbone [i](#)

In the following table, the Percentiles column shows the percent Ramachandran outliers of the chain as a percentile score with respect to all X-ray entries followed by that with respect to entries of similar resolution.

The Analysed column shows the number of residues for which the backbone conformation was analysed, and the total number of residues.

Mol	Chain	Analysed	Favoured	Allowed	Outliers	Percentiles	
2	S0	204/251 (81%)	151 (74%)	30 (15%)	23 (11%)	0	2
2	s0	204/251 (81%)	164 (80%)	25 (12%)	15 (7%)	1	7
3	S1	212/254 (84%)	152 (72%)	38 (18%)	22 (10%)	0	3
3	s1	214/254 (84%)	168 (78%)	33 (15%)	13 (6%)	1	10
4	S2	215/253 (85%)	168 (78%)	33 (15%)	14 (6%)	1	9
4	s2	215/253 (85%)	168 (78%)	33 (15%)	14 (6%)	1	9
5	S3	221/239 (92%)	187 (85%)	26 (12%)	8 (4%)	3	20
5	s3	221/239 (92%)	176 (80%)	35 (16%)	10 (4%)	2	15
6	S4	258/260 (99%)	202 (78%)	46 (18%)	10 (4%)	3	18
6	s4	258/260 (99%)	189 (73%)	53 (20%)	16 (6%)	1	10
7	S5	204/224 (91%)	155 (76%)	37 (18%)	12 (6%)	1	10
7	s5	204/224 (91%)	160 (78%)	29 (14%)	15 (7%)	1	7
8	S6	224/236 (95%)	193 (86%)	22 (10%)	9 (4%)	3	18
8	s6	216/236 (92%)	182 (84%)	22 (10%)	12 (6%)	2	11
9	S7	182/189 (96%)	134 (74%)	27 (15%)	21 (12%)	0	2

Continued on next page...

Continued from previous page...

Mol	Chain	Analysed	Favoured	Allowed	Outliers	Percentiles	
9	s7	184/189 (97%)	152 (83%)	20 (11%)	12 (6%)	1	9
10	S8	184/200 (92%)	151 (82%)	24 (13%)	9 (5%)	2	14
10	s8	184/200 (92%)	157 (85%)	20 (11%)	7 (4%)	3	19
11	S9	183/196 (93%)	149 (81%)	23 (13%)	11 (6%)	1	10
11	s9	183/196 (93%)	147 (80%)	27 (15%)	9 (5%)	2	14
12	C0	82/96 (85%)	71 (87%)	8 (10%)	3 (4%)	3	20
12	c0	82/96 (85%)	56 (68%)	16 (20%)	10 (12%)	0	1
13	C1	143/155 (92%)	116 (81%)	18 (13%)	9 (6%)	1	9
13	c1	143/155 (92%)	115 (80%)	21 (15%)	7 (5%)	2	14
14	C2	107/142 (75%)	70 (65%)	27 (25%)	10 (9%)	0	4
14	c2	107/142 (75%)	75 (70%)	22 (21%)	10 (9%)	0	4
15	C3	148/150 (99%)	124 (84%)	20 (14%)	4 (3%)	5	26
15	c3	148/150 (99%)	116 (78%)	23 (16%)	9 (6%)	1	10
16	C4	125/136 (92%)	81 (65%)	33 (26%)	11 (9%)	1	5
16	c4	126/136 (93%)	96 (76%)	15 (12%)	15 (12%)	0	2
17	C5	121/141 (86%)	95 (78%)	12 (10%)	14 (12%)	0	2
17	c5	128/141 (91%)	98 (77%)	19 (15%)	11 (9%)	1	5
18	C6	139/142 (98%)	116 (84%)	14 (10%)	9 (6%)	1	9
18	c6	140/142 (99%)	118 (84%)	13 (9%)	9 (6%)	1	9
19	C7	116/136 (85%)	82 (71%)	23 (20%)	11 (10%)	0	4
19	c7	113/136 (83%)	93 (82%)	13 (12%)	7 (6%)	1	10
20	C8	143/145 (99%)	116 (81%)	17 (12%)	10 (7%)	1	7
20	c8	143/145 (99%)	120 (84%)	16 (11%)	7 (5%)	2	14
21	C9	141/143 (99%)	115 (82%)	18 (13%)	8 (6%)	1	11
21	c9	141/143 (99%)	120 (85%)	15 (11%)	6 (4%)	2	16
22	D0	105/120 (88%)	89 (85%)	9 (9%)	7 (7%)	1	8
22	d0	108/120 (90%)	89 (82%)	14 (13%)	5 (5%)	2	15
23	D1	85/87 (98%)	66 (78%)	11 (13%)	8 (9%)	0	4
23	d1	85/87 (98%)	63 (74%)	17 (20%)	5 (6%)	1	10
24	D2	127/129 (98%)	116 (91%)	8 (6%)	3 (2%)	6	28
24	d2	127/129 (98%)	107 (84%)	17 (13%)	3 (2%)	6	28

Continued on next page...

Continued from previous page...

Mol	Chain	Analysed	Favoured	Allowed	Outliers	Percentiles	
25	D3	142/144 (99%)	109 (77%)	21 (15%)	12 (8%)	1	5
25	d3	142/144 (99%)	117 (82%)	20 (14%)	5 (4%)	3	21
26	D4	132/134 (98%)	109 (83%)	13 (10%)	10 (8%)	1	6
26	d4	132/134 (98%)	110 (83%)	15 (11%)	7 (5%)	2	12
27	D5	68/107 (64%)	48 (71%)	13 (19%)	7 (10%)	0	3
27	d5	67/107 (63%)	51 (76%)	15 (22%)	1 (2%)	10	38
28	D6	95/97 (98%)	56 (59%)	21 (22%)	18 (19%)	0	1
28	d6	95/97 (98%)	66 (70%)	20 (21%)	9 (10%)	0	4
29	D7	79/81 (98%)	61 (77%)	15 (19%)	3 (4%)	3	19
29	d7	79/81 (98%)	61 (77%)	14 (18%)	4 (5%)	2	13
30	D8	61/66 (92%)	50 (82%)	9 (15%)	2 (3%)	4	22
30	d8	61/66 (92%)	47 (77%)	11 (18%)	3 (5%)	2	14
31	D9	51/55 (93%)	39 (76%)	9 (18%)	3 (6%)	1	10
31	d9	51/55 (93%)	41 (80%)	8 (16%)	2 (4%)	3	18
32	E0	58/62 (94%)	46 (79%)	10 (17%)	2 (3%)	3	22
32	e0	60/62 (97%)	40 (67%)	12 (20%)	8 (13%)	0	1
33	E1	69/76 (91%)	35 (51%)	17 (25%)	17 (25%)	0	0
33	e1	74/76 (97%)	36 (49%)	21 (28%)	17 (23%)	0	0
34	SR	316/318 (99%)	263 (83%)	36 (11%)	17 (5%)	2	12
34	sR	316/318 (99%)	252 (80%)	53 (17%)	11 (4%)	3	21
35	SM	120/273 (44%)	91 (76%)	18 (15%)	11 (9%)	1	4
35	sM	61/273 (22%)	42 (69%)	11 (18%)	8 (13%)	0	1
39	L2	250/253 (99%)	213 (85%)	27 (11%)	10 (4%)	3	18
39	l2	250/253 (99%)	205 (82%)	30 (12%)	15 (6%)	1	10
40	L3	384/386 (100%)	316 (82%)	49 (13%)	19 (5%)	2	14
40	l3	384/386 (100%)	330 (86%)	39 (10%)	15 (4%)	3	18
41	L4	359/361 (99%)	291 (81%)	46 (13%)	22 (6%)	1	10
41	l4	359/361 (99%)	296 (82%)	43 (12%)	20 (6%)	2	11
42	L5	294/296 (99%)	232 (79%)	44 (15%)	18 (6%)	1	10
42	l5	292/296 (99%)	248 (85%)	38 (13%)	6 (2%)	7	31
43	L6	152/175 (87%)	122 (80%)	27 (18%)	3 (2%)	7	32

Continued on next page...

Continued from previous page...

Mol	Chain	Analysed	Favoured	Allowed	Outliers	Percentiles	
43	l6	153/175 (87%)	125 (82%)	24 (16%)	4 (3%)	5	27
44	L7	220/243 (90%)	185 (84%)	24 (11%)	11 (5%)	2	14
44	l7	221/243 (91%)	192 (87%)	21 (10%)	8 (4%)	3	20
45	L8	231/255 (91%)	190 (82%)	30 (13%)	11 (5%)	2	14
45	l8	229/255 (90%)	174 (76%)	40 (18%)	15 (7%)	1	8
46	L9	189/191 (99%)	145 (77%)	29 (15%)	15 (8%)	1	6
46	l9	189/191 (99%)	158 (84%)	24 (13%)	7 (4%)	3	20
47	M0	207/220 (94%)	161 (78%)	37 (18%)	9 (4%)	2	16
47	m0	209/220 (95%)	169 (81%)	29 (14%)	11 (5%)	2	12
48	M1	167/173 (96%)	128 (77%)	27 (16%)	12 (7%)	1	7
48	m1	167/173 (96%)	145 (87%)	9 (5%)	13 (8%)	1	6
49	M3	191/198 (96%)	153 (80%)	30 (16%)	8 (4%)	3	17
49	m3	192/198 (97%)	152 (79%)	27 (14%)	13 (7%)	1	8
50	M4	134/137 (98%)	116 (87%)	12 (9%)	6 (4%)	2	15
50	m4	135/137 (98%)	117 (87%)	15 (11%)	3 (2%)	6	30
51	M5	201/203 (99%)	175 (87%)	20 (10%)	6 (3%)	4	24
51	m5	201/203 (99%)	178 (89%)	18 (9%)	5 (2%)	5	27
52	M6	195/198 (98%)	174 (89%)	12 (6%)	9 (5%)	2	15
52	m6	195/198 (98%)	172 (88%)	20 (10%)	3 (2%)	10	38
53	M7	181/183 (99%)	151 (83%)	25 (14%)	5 (3%)	5	25
53	m7	153/183 (84%)	137 (90%)	14 (9%)	2 (1%)	12	40
54	M8	183/185 (99%)	156 (85%)	20 (11%)	7 (4%)	3	19
54	m8	183/185 (99%)	154 (84%)	21 (12%)	8 (4%)	2	16
55	M9	186/188 (99%)	164 (88%)	17 (9%)	5 (3%)	5	26
55	m9	186/188 (99%)	164 (88%)	20 (11%)	2 (1%)	14	45
56	N0	170/172 (99%)	151 (89%)	15 (9%)	4 (2%)	6	28
56	n0	170/172 (99%)	159 (94%)	9 (5%)	2 (1%)	13	42
57	N1	157/159 (99%)	131 (83%)	20 (13%)	6 (4%)	3	19
57	n1	157/159 (99%)	138 (88%)	16 (10%)	3 (2%)	8	34
58	N2	98/120 (82%)	73 (74%)	20 (20%)	5 (5%)	2	13
58	n2	96/120 (80%)	80 (83%)	13 (14%)	3 (3%)	4	23

Continued on next page...

Continued from previous page...

Mol	Chain	Analysed	Favoured	Allowed	Outliers	Percentiles	
59	N3	134/136 (98%)	117 (87%)	12 (9%)	5 (4%)	3	20
59	n3	134/136 (98%)	122 (91%)	4 (3%)	8 (6%)	1	10
60	N4	96/155 (62%)	66 (69%)	21 (22%)	9 (9%)	0	4
60	n4	133/155 (86%)	102 (77%)	23 (17%)	8 (6%)	1	10
61	N5	119/141 (84%)	103 (87%)	12 (10%)	4 (3%)	3	22
61	n5	118/141 (84%)	91 (77%)	17 (14%)	10 (8%)	1	5
62	N6	124/126 (98%)	104 (84%)	19 (15%)	1 (1%)	19	51
62	n6	124/126 (98%)	102 (82%)	17 (14%)	5 (4%)	3	18
63	N7	133/135 (98%)	112 (84%)	12 (9%)	9 (7%)	1	8
63	n7	133/135 (98%)	100 (75%)	26 (20%)	7 (5%)	2	12
64	N8	146/148 (99%)	113 (77%)	26 (18%)	7 (5%)	2	14
64	n8	146/148 (99%)	110 (75%)	25 (17%)	11 (8%)	1	7
65	N9	56/58 (97%)	46 (82%)	8 (14%)	2 (4%)	3	20
65	n9	56/58 (97%)	41 (73%)	9 (16%)	6 (11%)	0	3
66	O0	95/104 (91%)	83 (87%)	11 (12%)	1 (1%)	14	45
66	o0	98/104 (94%)	86 (88%)	10 (10%)	2 (2%)	7	32
67	O1	107/112 (96%)	96 (90%)	6 (6%)	5 (5%)	2	14
67	o1	107/112 (96%)	85 (79%)	15 (14%)	7 (6%)	1	9
68	O2	125/129 (97%)	110 (88%)	11 (9%)	4 (3%)	4	22
68	o2	125/129 (97%)	105 (84%)	16 (13%)	4 (3%)	4	22
69	O3	104/106 (98%)	96 (92%)	6 (6%)	2 (2%)	8	34
69	o3	104/106 (98%)	93 (89%)	9 (9%)	2 (2%)	8	34
70	O4	110/120 (92%)	96 (87%)	11 (10%)	3 (3%)	5	26
70	o4	110/120 (92%)	88 (80%)	18 (16%)	4 (4%)	3	20
71	O5	117/119 (98%)	95 (81%)	12 (10%)	10 (8%)	1	5
71	o5	117/119 (98%)	94 (80%)	21 (18%)	2 (2%)	9	35
72	O6	97/99 (98%)	76 (78%)	12 (12%)	9 (9%)	0	4
72	o6	97/99 (98%)	76 (78%)	11 (11%)	10 (10%)	0	3
73	O7	85/87 (98%)	69 (81%)	14 (16%)	2 (2%)	6	28
73	o7	85/87 (98%)	70 (82%)	14 (16%)	1 (1%)	13	42
74	O8	75/77 (97%)	66 (88%)	7 (9%)	2 (3%)	5	26

Continued on next page...

Continued from previous page...

Mol	Chain	Analysed	Favoured	Allowed	Outliers	Percentiles	
74	o8	75/77 (97%)	61 (81%)	9 (12%)	5 (7%)	1	8
75	O9	48/50 (96%)	35 (73%)	10 (21%)	3 (6%)	1	9
75	o9	48/50 (96%)	39 (81%)	9 (19%)	0	100	100
76	Q0	50/52 (96%)	43 (86%)	6 (12%)	1 (2%)	7	32
76	q0	50/52 (96%)	48 (96%)	1 (2%)	1 (2%)	7	32
77	Q1	23/25 (92%)	21 (91%)	2 (9%)	0	100	100
77	q1	23/25 (92%)	20 (87%)	2 (9%)	1 (4%)	2	16
78	Q2	103/105 (98%)	85 (82%)	13 (13%)	5 (5%)	2	14
78	q2	103/105 (98%)	88 (85%)	9 (9%)	6 (6%)	1	11
79	Q3	89/91 (98%)	70 (79%)	13 (15%)	6 (7%)	1	8
79	q3	89/91 (98%)	79 (89%)	9 (10%)	1 (1%)	14	45
81	p0	117/311 (38%)	97 (83%)	14 (12%)	6 (5%)	2	13
83	f	146/157 (93%)	91 (62%)	35 (24%)	20 (14%)	0	1
All	All	22316/24284 (92%)	18108 (81%)	2992 (13%)	1216 (5%)	2	12

5 of 1216 Ramachandran outliers are listed below:

Mol	Chain	Res	Type
2	S0	95	ALA
2	S0	158	VAL
2	S0	190	ASP
2	S0	192	THR
3	S1	35	PRO

5.3.2 Protein sidechains [i](#)

In the following table, the Percentiles column shows the percent sidechain outliers of the chain as a percentile score with respect to all X-ray entries followed by that with respect to entries of similar resolution.

The Analysed column shows the number of residues for which the sidechain conformation was analysed, and the total number of residues.

Mol	Chain	Analysed	Rotameric	Outliers	Percentiles	
2	S0	164/209 (78%)	143 (87%)	21 (13%)	4	18
2	s0	165/209 (79%)	140 (85%)	25 (15%)	3	13
3	S1	191/223 (86%)	169 (88%)	22 (12%)	5	22

Continued on next page...

Continued from previous page...

Mol	Chain	Analysed	Rotameric	Outliers	Percentiles	
3	s1	192/223 (86%)	164 (85%)	28 (15%)	3	14
4	S2	176/204 (86%)	155 (88%)	21 (12%)	5	21
4	s2	176/204 (86%)	141 (80%)	35 (20%)	1	5
5	S3	182/194 (94%)	157 (86%)	25 (14%)	3	16
5	s3	182/194 (94%)	162 (89%)	20 (11%)	6	24
6	S4	221/221 (100%)	192 (87%)	29 (13%)	4	17
6	s4	221/221 (100%)	188 (85%)	33 (15%)	3	13
7	S5	173/190 (91%)	157 (91%)	16 (9%)	9	31
7	s5	173/190 (91%)	147 (85%)	26 (15%)	3	13
8	S6	188/201 (94%)	165 (88%)	23 (12%)	5	20
8	s6	187/201 (93%)	165 (88%)	22 (12%)	5	21
9	S7	165/169 (98%)	145 (88%)	20 (12%)	5	20
9	s7	165/169 (98%)	150 (91%)	15 (9%)	9	31
10	S8	150/161 (93%)	136 (91%)	14 (9%)	9	30
10	s8	150/161 (93%)	131 (87%)	19 (13%)	4	19
11	S9	158/165 (96%)	133 (84%)	25 (16%)	2	11
11	s9	158/165 (96%)	132 (84%)	26 (16%)	2	10
12	C0	77/77 (100%)	71 (92%)	6 (8%)	12	38
12	c0	73/77 (95%)	66 (90%)	7 (10%)	8	29
13	C1	129/129 (100%)	117 (91%)	12 (9%)	9	30
13	c1	129/129 (100%)	113 (88%)	16 (12%)	4	19
14	C2	88/106 (83%)	73 (83%)	15 (17%)	2	9
14	c2	88/106 (83%)	80 (91%)	8 (9%)	9	31
15	C3	127/127 (100%)	110 (87%)	17 (13%)	4	16
15	c3	127/127 (100%)	110 (87%)	17 (13%)	4	16
16	C4	81/104 (78%)	67 (83%)	14 (17%)	2	8
16	c4	97/104 (93%)	78 (80%)	19 (20%)	1	5
17	C5	101/113 (89%)	91 (90%)	10 (10%)	8	28
17	c5	103/113 (91%)	89 (86%)	14 (14%)	3	16
18	C6	117/118 (99%)	103 (88%)	14 (12%)	5	20
18	c6	118/118 (100%)	102 (86%)	16 (14%)	3	16

Continued on next page...

Continued from previous page...

Mol	Chain	Analysed	Rotameric	Outliers	Percentiles	
19	C7	94/124 (76%)	79 (84%)	15 (16%)	2	11
19	c7	92/124 (74%)	82 (89%)	10 (11%)	6	24
20	C8	128/128 (100%)	104 (81%)	24 (19%)	1	6
20	c8	128/128 (100%)	109 (85%)	19 (15%)	3	13
21	C9	115/115 (100%)	99 (86%)	16 (14%)	3	16
21	c9	115/115 (100%)	98 (85%)	17 (15%)	3	13
22	D0	100/113 (88%)	91 (91%)	9 (9%)	9	32
22	d0	103/113 (91%)	91 (88%)	12 (12%)	5	21
23	D1	74/74 (100%)	65 (88%)	9 (12%)	5	20
23	d1	74/74 (100%)	66 (89%)	8 (11%)	6	24
24	D2	110/110 (100%)	94 (86%)	16 (14%)	3	14
24	d2	110/110 (100%)	93 (84%)	17 (16%)	2	12
25	D3	119/119 (100%)	105 (88%)	14 (12%)	5	21
25	d3	119/119 (100%)	109 (92%)	10 (8%)	11	35
26	D4	112/112 (100%)	103 (92%)	9 (8%)	12	37
26	d4	112/112 (100%)	97 (87%)	15 (13%)	4	16
27	D5	61/88 (69%)	48 (79%)	13 (21%)	1	4
27	d5	61/88 (69%)	51 (84%)	10 (16%)	2	10
28	D6	83/83 (100%)	73 (88%)	10 (12%)	5	20
28	d6	83/83 (100%)	70 (84%)	13 (16%)	2	12
29	D7	70/70 (100%)	62 (89%)	8 (11%)	5	22
29	d7	70/70 (100%)	62 (89%)	8 (11%)	5	22
30	D8	56/59 (95%)	48 (86%)	8 (14%)	3	15
30	d8	56/59 (95%)	46 (82%)	10 (18%)	2	8
31	D9	47/48 (98%)	39 (83%)	8 (17%)	2	9
31	d9	47/48 (98%)	37 (79%)	10 (21%)	1	4
32	E0	51/53 (96%)	47 (92%)	4 (8%)	12	38
32	e0	53/53 (100%)	39 (74%)	14 (26%)	0	1
33	E1	62/66 (94%)	51 (82%)	11 (18%)	2	8
33	e1	66/66 (100%)	55 (83%)	11 (17%)	2	10
34	SR	259/261 (99%)	227 (88%)	32 (12%)	4	19

Continued on next page...

Continued from previous page...

Mol	Chain	Analysed	Rotameric	Outliers	Percentiles	
34	sR	260/261 (100%)	243 (94%)	17 (6%)	17	46
35	SM	97/183 (53%)	79 (81%)	18 (19%)	1	7
35	sM	54/183 (30%)	46 (85%)	8 (15%)	3	13
39	L2	193/195 (99%)	166 (86%)	27 (14%)	3	16
39	l2	192/195 (98%)	161 (84%)	31 (16%)	2	10
40	L3	319/322 (99%)	267 (84%)	52 (16%)	2	10
40	l3	319/322 (99%)	261 (82%)	58 (18%)	1	7
41	L4	288/288 (100%)	252 (88%)	36 (12%)	4	19
41	l4	288/288 (100%)	248 (86%)	40 (14%)	3	16
42	L5	244/244 (100%)	208 (85%)	36 (15%)	3	13
42	l5	243/244 (100%)	200 (82%)	43 (18%)	2	8
43	L6	134/152 (88%)	116 (87%)	18 (13%)	4	16
43	l6	135/152 (89%)	115 (85%)	20 (15%)	3	13
44	L7	186/204 (91%)	162 (87%)	24 (13%)	4	18
44	l7	187/204 (92%)	164 (88%)	23 (12%)	4	20
45	L8	187/207 (90%)	165 (88%)	22 (12%)	5	21
45	l8	177/207 (86%)	153 (86%)	24 (14%)	3	16
46	L9	171/171 (100%)	135 (79%)	36 (21%)	1	4
46	l9	171/171 (100%)	143 (84%)	28 (16%)	2	10
47	M0	177/186 (95%)	144 (81%)	33 (19%)	1	7
47	m0	179/186 (96%)	149 (83%)	30 (17%)	2	9
48	M1	147/150 (98%)	117 (80%)	30 (20%)	1	4
48	m1	147/150 (98%)	125 (85%)	22 (15%)	3	13
49	M3	154/158 (98%)	133 (86%)	21 (14%)	3	16
49	m3	154/158 (98%)	127 (82%)	27 (18%)	2	8
50	M4	107/108 (99%)	93 (87%)	14 (13%)	4	17
50	m4	108/108 (100%)	94 (87%)	14 (13%)	4	17
51	M5	175/175 (100%)	151 (86%)	24 (14%)	3	16
51	m5	175/175 (100%)	154 (88%)	21 (12%)	5	20
52	M6	160/161 (99%)	134 (84%)	26 (16%)	2	10
52	m6	160/161 (99%)	139 (87%)	21 (13%)	4	17

Continued on next page...

Continued from previous page...

Mol	Chain	Analysed	Rotameric	Outliers	Percentiles	
53	M7	140/145 (97%)	120 (86%)	20 (14%)	3	15
53	m7	125/145 (86%)	106 (85%)	19 (15%)	3	13
54	M8	150/150 (100%)	132 (88%)	18 (12%)	5	20
54	m8	150/150 (100%)	126 (84%)	24 (16%)	2	11
55	M9	153/153 (100%)	136 (89%)	17 (11%)	6	23
55	m9	153/153 (100%)	133 (87%)	20 (13%)	4	17
56	N0	156/156 (100%)	132 (85%)	24 (15%)	2	12
56	n0	156/156 (100%)	133 (85%)	23 (15%)	3	14
57	N1	136/136 (100%)	108 (79%)	28 (21%)	1	4
57	n1	136/136 (100%)	113 (83%)	23 (17%)	2	9
58	N2	87/106 (82%)	79 (91%)	8 (9%)	9	31
58	n2	85/106 (80%)	73 (86%)	12 (14%)	3	16
59	N3	104/104 (100%)	90 (86%)	14 (14%)	4	16
59	n3	104/104 (100%)	91 (88%)	13 (12%)	4	19
60	N4	57/129 (44%)	52 (91%)	5 (9%)	10	33
60	n4	100/129 (78%)	95 (95%)	5 (5%)	24	55
61	N5	104/117 (89%)	83 (80%)	21 (20%)	1	5
61	n5	104/117 (89%)	90 (86%)	14 (14%)	4	16
62	N6	109/109 (100%)	90 (83%)	19 (17%)	2	8
62	n6	109/109 (100%)	93 (85%)	16 (15%)	3	14
63	N7	115/115 (100%)	99 (86%)	16 (14%)	3	16
63	n7	115/115 (100%)	97 (84%)	18 (16%)	2	12
64	N8	118/118 (100%)	98 (83%)	20 (17%)	2	9
64	n8	118/118 (100%)	101 (86%)	17 (14%)	3	15
65	N9	46/46 (100%)	40 (87%)	6 (13%)	4	17
65	n9	46/46 (100%)	41 (89%)	5 (11%)	6	24
66	O0	81/87 (93%)	69 (85%)	12 (15%)	3	13
66	o0	84/87 (97%)	72 (86%)	12 (14%)	3	15
67	O1	92/96 (96%)	80 (87%)	12 (13%)	4	17
67	o1	94/96 (98%)	76 (81%)	18 (19%)	1	6
68	O2	109/110 (99%)	94 (86%)	15 (14%)	3	16

Continued on next page...

Continued from previous page...

Mol	Chain	Analysed	Rotameric	Outliers	Percentiles	
68	o2	109/110 (99%)	87 (80%)	22 (20%)	1	5
69	O3	90/90 (100%)	75 (83%)	15 (17%)	2	10
69	o3	90/90 (100%)	76 (84%)	14 (16%)	2	12
70	O4	95/102 (93%)	84 (88%)	11 (12%)	5	22
70	o4	95/102 (93%)	86 (90%)	9 (10%)	8	29
71	O5	104/104 (100%)	95 (91%)	9 (9%)	10	34
71	o5	103/104 (99%)	90 (87%)	13 (13%)	4	19
72	O6	81/81 (100%)	65 (80%)	16 (20%)	1	5
72	o6	80/81 (99%)	59 (74%)	21 (26%)	0	2
73	O7	70/70 (100%)	59 (84%)	11 (16%)	2	12
73	o7	70/70 (100%)	62 (89%)	8 (11%)	5	22
74	O8	68/68 (100%)	56 (82%)	12 (18%)	2	8
74	o8	67/68 (98%)	57 (85%)	10 (15%)	3	13
75	O9	45/45 (100%)	38 (84%)	7 (16%)	2	12
75	o9	45/45 (100%)	42 (93%)	3 (7%)	16	45
76	Q0	47/47 (100%)	37 (79%)	10 (21%)	1	4
76	q0	47/47 (100%)	39 (83%)	8 (17%)	2	9
77	Q1	23/23 (100%)	20 (87%)	3 (13%)	4	17
77	q1	23/23 (100%)	17 (74%)	6 (26%)	0	2
78	Q2	90/90 (100%)	74 (82%)	16 (18%)	2	8
78	q2	90/90 (100%)	72 (80%)	18 (20%)	1	5
79	Q3	71/71 (100%)	60 (84%)	11 (16%)	2	12
79	q3	71/71 (100%)	61 (86%)	10 (14%)	3	16
81	p0	105/232 (45%)	93 (89%)	12 (11%)	5	22
83	f	124/133 (93%)	107 (86%)	17 (14%)	3	16
84	B	2/2 (100%)	2 (100%)	0	100	100
84	C	2/2 (100%)	2 (100%)	0	100	100
All	All	18853/20181 (93%)	16183 (86%)	2670 (14%)	3	15

5 of 2670 residues with a non-rotameric sidechain are listed below:

Mol	Chain	Res	Type
35	sM	43	ASP

Continued on next page...

Continued from previous page...

Mol	Chain	Res	Type
54	m8	86	THR
40	l3	110	LEU
35	sM	23	LYS
45	l8	74	THR

Sometimes sidechains can be flipped to improve hydrogen bonding and reduce clashes. 5 of 40 such sidechains are listed below:

Mol	Chain	Res	Type
26	d4	34	ASN
53	m7	137	ASN
32	e0	17	GLN
45	l8	59	GLN
65	n9	12	GLN

5.3.3 RNA [i](#)

Mol	Chain	Analysed	Backbone Outliers	Pucker Outliers
1	2	1776/1800 (98%)	455 (25%)	40 (2%)
1	6	1791/1800 (99%)	447 (24%)	29 (1%)
36	1	3145/3396 (92%)	672 (21%)	53 (1%)
36	5	3163/3396 (93%)	649 (20%)	52 (1%)
37	3	120/121 (99%)	11 (9%)	0
37	7	120/121 (99%)	13 (10%)	0
38	4	157/158 (99%)	32 (20%)	3 (1%)
38	8	157/158 (99%)	34 (21%)	0
All	All	10429/10950 (95%)	2313 (22%)	177 (1%)

5 of 2313 RNA backbone outliers are listed below:

Mol	Chain	Res	Type
1	2	2	A
1	2	4	C
1	2	6	G
1	2	17	C
1	2	23	G

5 of 177 RNA pucker outliers are listed below:

Mol	Chain	Res	Type
1	6	1097	U

Continued on next page...

Continued from previous page...

Mol	Chain	Res	Type
36	5	1331	U
1	6	1481	C
36	5	916	G
36	5	1816	A

5.4 Non-standard residues in protein, DNA, RNA chains [i](#)

6 non-standard protein/DNA/RNA residues are modelled in this entry.

In the following table, the Counts columns list the number of bonds (or angles) for which Mogul statistics could be retrieved, the number of bonds (or angles) that are observed in the model and the number of bonds (or angles) that are defined in the Chemical Component Dictionary. The Link column lists molecule types, if any, to which the group is linked. The Z score for a bond length (or angle) is the number of standard deviations the observed value is removed from the expected value. A bond length (or angle) with $|Z| > 2$ is considered an outlier worth inspection. RMSZ is the root-mean-square of all Z scores of the bond lengths (or angles).

Mol	Type	Chain	Res	Link	Bond lengths			Bond angles		
					Counts	RMSZ	# Z > 2	Counts	RMSZ	# Z > 2
84	CH	C	75	84,87	16,21,22	0.96	2 (12%)	20,30,33	1.91	2 (10%)
84	CH	C	74	84	16,18,22	0.92	1 (6%)	20,26,33	1.75	2 (10%)
84	8AN	B	76	84,87	19,24,25	1.06	1 (5%)	13,35,38	1.55	3 (23%)
84	CH	B	75	84,87	16,21,22	0.73	0	20,30,33	1.91	2 (10%)
84	CH	B	74	84	16,21,22	1.02	1 (6%)	20,30,33	1.81	2 (10%)
84	8AN	C	76	84,87	19,24,25	1.11	1 (5%)	13,35,38	1.52	2 (15%)

In the following table, the Chirals column lists the number of chiral outliers, the number of chiral centers analysed, the number of these observed in the model and the number defined in the Chemical Component Dictionary. Similar counts are reported in the Torsion and Rings columns. '-' means no outliers of that kind were identified.

Mol	Type	Chain	Res	Link	Chirals	Torsions	Rings
84	CH	C	75	84,87	-	1/5/25/26	0/2/2/2
84	CH	C	74	84	-	2/4/22/26	0/2/2/2
84	8AN	B	76	84,87	-	3/3/25/26	0/3/3/3
84	CH	B	75	84,87	-	0/5/25/26	0/2/2/2
84	CH	B	74	84	-	0/5/25/26	0/2/2/2
84	8AN	C	76	84,87	-	3/3/25/26	0/3/3/3

The worst 5 of 6 bond length outliers are listed below:

Mol	Chain	Res	Type	Atoms	Z	Observed(Å)	Ideal(Å)
84	B	74	CH	C4-N3	-2.99	1.33	1.37
84	C	74	CH	C4-N3	-2.79	1.33	1.37
84	B	76	8AN	C5-C4	2.61	1.47	1.40
84	C	75	CH	C5-C4	2.46	1.43	1.39
84	C	76	8AN	C5-C4	2.34	1.47	1.40

The worst 5 of 13 bond angle outliers are listed below:

Mol	Chain	Res	Type	Atoms	Z	Observed(°)	Ideal(°)
84	B	74	CH	C5-C4-N3	7.27	122.18	118.04
84	C	75	CH	C5-C4-N3	7.25	122.17	118.04
84	B	75	CH	C5-C4-N3	6.07	121.50	118.04
84	C	74	CH	C5-C4-N3	5.87	121.38	118.04
84	B	75	CH	C5-C4-N4	-5.28	118.74	123.88

There are no chirality outliers.

5 of 9 torsion outliers are listed below:

Mol	Chain	Res	Type	Atoms
84	C	74	CH	C3'-C4'-C5'-O5'
84	C	74	CH	O4'-C4'-C5'-O5'
84	C	76	8AN	C3'-C4'-C5'-O5'
84	B	76	8AN	C3'-C4'-C5'-O5'
84	C	76	8AN	O4'-C4'-C5'-O5'

There are no ring outliers.

No monomer is involved in short contacts.

5.5 Carbohydrates [i](#)

There are no monosaccharides in this entry.

5.6 Ligand geometry [i](#)

Of 33 ligands modelled in this entry, 28 are monoatomic - leaving 5 for Mogul analysis.

In the following table, the Counts columns list the number of bonds (or angles) for which Mogul statistics could be retrieved, the number of bonds (or angles) that are observed in the model and the number of bonds (or angles) that are defined in the Chemical Component Dictionary. The Link column lists molecule types, if any, to which the group is linked. The Z score for a bond length (or angle) is the number of standard deviations the observed value is removed from the

expected value. A bond length (or angle) with $|Z| > 2$ is considered an outlier worth inspection. RMSZ is the root-mean-square of all Z scores of the bond lengths (or angles).

Mol	Type	Chain	Res	Link	Bond lengths			Bond angles		
					Counts	RMSZ	# Z > 2	Counts	RMSZ	# Z > 2
88	OHX	1	3406	-	0,6,6	-	-	-		
88	OHX	1	3405	-	0,6,6	-	-	-		
86	SPS	B	3401	87	20,23,23	3.42	11 (55%)	18,30,30	3.02	7 (38%)
86	SPS	1	3401	-	20,23,23	3.43	10 (50%)	18,30,30	2.96	6 (33%)
88	OHX	5	3406	-	0,6,6	-	-	-		

In the following table, the Chirals column lists the number of chiral outliers, the number of chiral centers analysed, the number of these observed in the model and the number defined in the Chemical Component Dictionary. Similar counts are reported in the Torsion and Rings columns. '-' means no outliers of that kind were identified.

Mol	Type	Chain	Res	Link	Chirals	Torsions	Rings
86	SPS	1	3401	-	-	3/15/18/18	0/1/1/1
86	SPS	B	3401	87	-	3/15/18/18	0/1/1/1

The worst 5 of 21 bond length outliers are listed below:

Mol	Chain	Res	Type	Atoms	Z	Observed(Å)	Ideal(Å)
86	1	3401	SPS	C9-C10	-8.24	1.31	1.48
86	B	3401	SPS	C9-C10	-7.97	1.31	1.48
86	B	3401	SPS	C9-C8	7.78	1.53	1.33
86	1	3401	SPS	C9-C8	7.48	1.52	1.33
86	B	3401	SPS	O13-C13	-5.45	1.19	1.42

The worst 5 of 13 bond angle outliers are listed below:

Mol	Chain	Res	Type	Atoms	Z	Observed(°)	Ideal(°)
86	B	3401	SPS	C3-N2-C1	8.31	122.15	115.14
86	1	3401	SPS	C3-N2-C1	7.60	121.56	115.14
86	1	3401	SPS	C6-C1-N2	-7.07	119.47	124.40
86	B	3401	SPS	C6-C1-N2	-6.31	120.00	124.40
86	B	3401	SPS	C18-S17-C16	3.98	111.12	100.10

There are no chirality outliers.

5 of 6 torsion outliers are listed below:

Mol	Chain	Res	Type	Atoms
86	B	3401	SPS	N11-C12-C13-O13

Continued on next page...

Continued from previous page...

Mol	Chain	Res	Type	Atoms
86	1	3401	SPS	C14-C12-C13-O13
86	B	3401	SPS	C14-C12-C13-O13
86	1	3401	SPS	N11-C12-C13-O13
86	1	3401	SPS	C5-C6-C8-C9

There are no ring outliers.

No monomer is involved in short contacts.

The following is a two-dimensional graphical depiction of Mogul quality analysis of bond lengths, bond angles, torsion angles, and ring geometry for all instances of the Ligand of Interest. In addition, ligands with molecular weight > 250 and outliers as shown on the validation Tables will also be included. For torsion angles, if less than 5% of the Mogul distribution of torsion angles is within 10 degrees of the torsion angle in question, then that torsion angle is considered an outlier. Any bond that is central to one or more torsion angles identified as an outlier by Mogul will be highlighted in the graph. For rings, the root-mean-square deviation (RMSD) between the ring in question and similar rings identified by Mogul is calculated over all ring torsion angles. If the average RMSD is greater than 60 degrees and the minimal RMSD between the ring in question and any Mogul-identified rings is also greater than 60 degrees, then that ring is considered an outlier. The outliers are highlighted in purple. The color gray indicates Mogul did not find sufficient equivalents in the CSD to analyse the geometry.

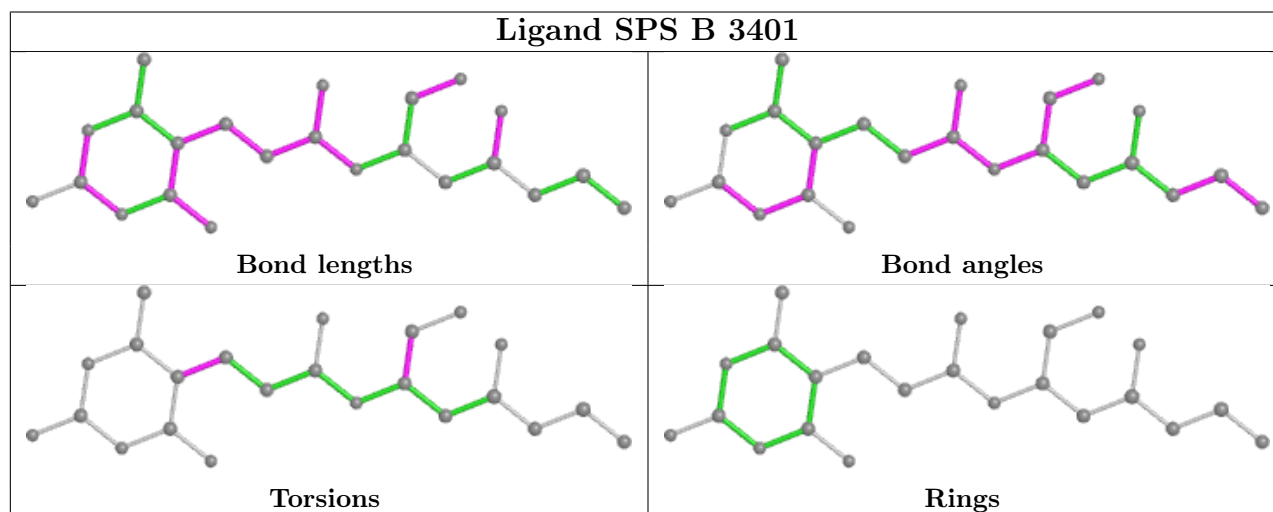

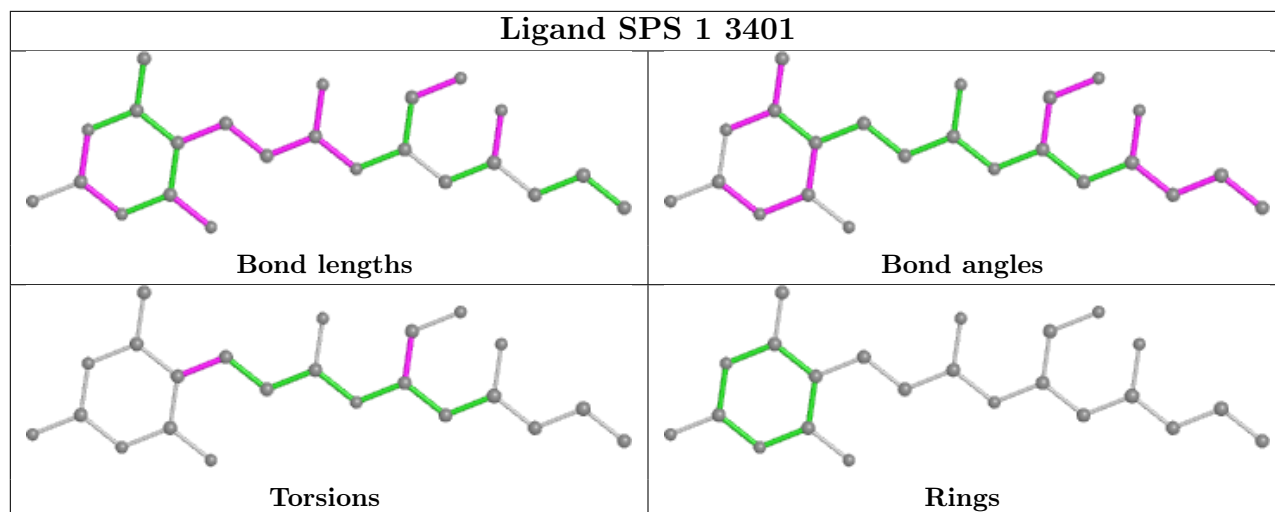

5.7 Other polymers [i](#)

There are no such residues in this entry.

5.8 Polymer linkage issues [i](#)

The following chains have linkage breaks:

Mol	Chain	Number of breaks
1	2	2
80	m2	2
35	sM	1
35	SM	1
84	C	1
84	B	1
12	c0	1
36	5	1

The worst 5 of 10 chain breaks are listed below:

Model	Chain	Residue-1	Atom-1	Residue-2	Atom-2	Distance (Å)
1	sM	139:UNK	C	155:UNK	N	38.68
1	SM	141:ALA	C	151:UNK	N	26.53
1	C	76:8AN	P	77:PRO	N	11.34
1	B	76:8AN	P	77:PRO	N	11.32
1	c0	84:UNK	C	87:UNK	N	8.84

6 Fit of model and data i

6.1 Protein, DNA and RNA chains i

In the following table, the column labelled '#RSRZ > 2' contains the number (and percentage) of RSRZ outliers, followed by percent RSRZ outliers for the chain as percentile scores relative to all X-ray entries and entries of similar resolution. The OWAB column contains the minimum, median, 95th percentile and maximum values of the occupancy-weighted average B-factor per residue. The column labelled 'Q < 0.9' lists the number of (and percentage) of residues with an average occupancy less than 0.9.

Mol	Chain	Analysed	<RSRZ>	#RSRZ>2	OWAB(Å ²)	Q<0.9
1	2	1781/1800 (98%)	0.48	91 (5%) 28 26	60, 98, 170, 210	0
1	6	1795/1800 (99%)	0.27	58 (3%) 47 46	44, 86, 157, 204	0
2	S0	206/251 (82%)	1.22	50 (24%) 0 0	100, 112, 123, 128	0
2	s0	206/251 (82%)	1.16	50 (24%) 0 0	80, 97, 111, 117	0
3	S1	214/254 (84%)	1.60	76 (35%) 0 0	110, 145, 169, 175	0
3	s1	216/254 (85%)	1.03	44 (20%) 1 1	80, 96, 114, 123	0
4	S2	217/253 (85%)	0.73	30 (13%) 2 2	83, 96, 109, 113	0
4	s2	217/253 (85%)	0.45	9 (4%) 37 35	68, 79, 93, 108	0
5	S3	223/239 (93%)	0.67	25 (11%) 5 5	91, 100, 123, 128	0
5	s3	223/239 (93%)	1.46	72 (32%) 0 0	86, 112, 131, 137	0
6	S4	260/260 (100%)	1.31	66 (25%) 0 0	77, 99, 107, 124	0
6	s4	260/260 (100%)	1.20	60 (23%) 0 1	60, 82, 92, 119	0
7	S5	206/224 (91%)	1.21	39 (18%) 1 1	104, 124, 131, 134	0
7	s5	206/224 (91%)	0.62	21 (10%) 6 6	87, 108, 123, 130	0
8	S6	226/236 (95%)	0.85	41 (18%) 1 1	77, 105, 126, 132	0
8	s6	218/236 (92%)	0.49	21 (9%) 8 8	60, 89, 106, 114	0
9	S7	184/189 (97%)	0.90	30 (16%) 1 2	102, 121, 136, 142	0
9	s7	186/189 (98%)	0.67	23 (12%) 4 3	77, 104, 130, 134	0
10	S8	188/200 (94%)	0.78	20 (10%) 6 6	70, 86, 119, 129	0
10	s8	188/200 (94%)	1.01	28 (14%) 2 2	56, 73, 113, 130	0
11	S9	185/196 (94%)	1.69	71 (38%) 0 0	89, 106, 130, 141	0
11	s9	185/196 (94%)	1.21	43 (23%) 0 1	71, 88, 115, 126	0
12	C0	83/96 (86%)	2.34	52 (62%) 0 0	94, 112, 122, 126	0
12	c0	83/96 (86%)	2.04	40 (48%) 0 0	103, 131, 145, 149	0

Continued on next page...

Continued from previous page...

Mol	Chain	Analysed	<RSRZ>	#RSRZ>2	OWAB(Å ²)	Q<0.9
13	C1	144/155 (92%)	1.04	21 (14%) 2 2	73, 83, 101, 113	0
13	c1	144/155 (92%)	0.84	9 (6%) 20 20	59, 70, 91, 113	0
14	C2	108/142 (76%)	0.53	14 (12%) 3 3	137, 145, 150, 152	0
14	c2	108/142 (76%)	0.82	15 (13%) 2 2	167, 183, 196, 199	0
15	C3	150/150 (100%)	0.59	16 (10%) 6 5	82, 95, 111, 115	0
15	c3	150/150 (100%)	0.14	5 (3%) 46 44	66, 79, 95, 100	0
16	C4	127/136 (93%)	1.42	35 (27%) 0 0	84, 142, 156, 161	0
16	c4	128/136 (94%)	1.53	43 (33%) 0 0	67, 101, 113, 116	0
17	C5	122/141 (86%)	0.94	21 (17%) 1 1	88, 99, 111, 117	0
17	c5	129/141 (91%)	0.67	16 (12%) 4 3	86, 103, 113, 119	0
18	C6	141/142 (99%)	1.70	46 (32%) 0 0	91, 112, 117, 120	0
18	c6	142/142 (100%)	0.81	25 (17%) 1 1	83, 102, 115, 126	0
19	C7	120/136 (88%)	1.44	32 (26%) 0 0	97, 109, 125, 129	0
19	c7	117/136 (86%)	0.37	10 (8%) 10 10	88, 101, 115, 119	0
20	C8	145/145 (100%)	0.95	24 (16%) 1 2	85, 110, 131, 138	0
20	c8	145/145 (100%)	0.81	23 (15%) 1 2	86, 101, 116, 126	0
21	C9	143/143 (100%)	1.40	37 (25%) 0 0	96, 112, 122, 126	0
21	c9	143/143 (100%)	1.63	51 (35%) 0 0	85, 97, 112, 118	0
22	D0	107/120 (89%)	0.98	20 (18%) 1 1	86, 112, 123, 125	0
22	d0	110/120 (91%)	2.37	58 (52%) 0 0	84, 114, 138, 147	0
23	D1	87/87 (100%)	0.91	16 (18%) 1 1	96, 104, 119, 127	0
23	d1	87/87 (100%)	0.70	9 (10%) 6 6	76, 88, 104, 112	0
24	D2	129/129 (100%)	0.64	11 (8%) 10 10	83, 95, 101, 109	0
24	d2	129/129 (100%)	0.47	10 (7%) 13 12	64, 74, 81, 87	0
25	D3	144/144 (100%)	0.81	18 (12%) 3 3	69, 77, 86, 96	0
25	d3	144/144 (100%)	0.60	7 (4%) 29 27	56, 61, 71, 79	0
26	D4	134/134 (100%)	1.30	34 (25%) 0 0	86, 107, 118, 129	0
26	d4	134/134 (100%)	0.36	10 (7%) 14 13	68, 90, 105, 110	0
27	D5	70/107 (65%)	1.51	24 (34%) 0 0	119, 130, 139, 140	0
27	d5	69/107 (64%)	1.51	19 (27%) 0 0	99, 113, 123, 125	0
28	D6	97/97 (100%)	2.00	44 (45%) 0 0	88, 106, 154, 159	0

Continued on next page...

Continued from previous page...

Mol	Chain	Analysed	<RSRZ>	#RSRZ>2	OWAB(Å ²)	Q<0.9
28	d6	97/97 (100%)	1.37	26 (26%) 0 0	70, 87, 116, 123	0
29	D7	81/81 (100%)	1.23	17 (20%) 1 1	98, 110, 135, 141	0
29	d7	81/81 (100%)	0.94	13 (16%) 1 2	80, 93, 121, 128	0
30	D8	63/66 (95%)	1.20	13 (20%) 1 1	111, 127, 139, 143	0
30	d8	63/66 (95%)	1.06	10 (15%) 1 2	104, 116, 127, 129	0
31	D9	53/55 (96%)	1.26	12 (22%) 0 1	84, 91, 107, 112	0
31	d9	53/55 (96%)	2.26	26 (49%) 0 0	82, 92, 128, 139	0
32	E0	60/62 (96%)	1.83	21 (35%) 0 0	78, 107, 129, 134	0
32	e0	62/62 (100%)	0.84	11 (17%) 1 1	63, 88, 109, 122	0
33	E1	71/76 (93%)	0.66	9 (12%) 3 3	107, 133, 145, 148	0
33	e1	76/76 (100%)	1.08	20 (26%) 0 0	112, 158, 170, 175	0
34	SR	318/318 (100%)	1.49	102 (32%) 0 0	109, 120, 132, 146	0
34	sR	318/318 (100%)	1.56	105 (33%) 0 0	110, 126, 140, 150	0
35	SM	121/273 (44%)	0.86	22 (18%) 1 1	59, 94, 111, 116	0
35	sM	63/273 (23%)	1.59	22 (34%) 0 0	55, 105, 111, 112	0
36	1	3149/3396 (92%)	0.19	48 (1%) 73 72	35, 59, 123, 212	0
36	5	3169/3396 (93%)	0.21	48 (1%) 73 72	35, 54, 124, 188	0
37	3	121/121 (100%)	0.00	0 100 100	43, 76, 90, 96	0
37	7	121/121 (100%)	-0.09	0 100 100	39, 59, 70, 75	0
38	4	158/158 (100%)	0.12	2 (1%) 77 77	43, 61, 91, 130	0
38	8	158/158 (100%)	0.11	1 (0%) 89 90	43, 63, 96, 120	0
39	L2	252/253 (99%)	0.36	9 (3%) 42 40	42, 61, 77, 82	0
39	l2	252/253 (99%)	0.41	11 (4%) 34 33	43, 59, 74, 83	0
40	L3	386/386 (100%)	0.45	20 (5%) 27 25	42, 63, 77, 85	0
40	l3	386/386 (100%)	0.33	8 (2%) 63 62	34, 49, 62, 77	0
41	L4	361/361 (100%)	-0.03	0 100 100	40, 54, 70, 71	0
41	l4	361/361 (100%)	0.14	2 (0%) 89 90	40, 57, 73, 88	0
42	L5	296/296 (100%)	1.15	68 (22%) 0 1	58, 81, 97, 111	0
42	l5	294/296 (99%)	0.61	22 (7%) 14 13	49, 60, 84, 93	0
43	L6	156/175 (89%)	0.59	11 (7%) 16 16	49, 57, 72, 79	0
43	l6	157/175 (89%)	0.19	5 (3%) 47 46	49, 57, 75, 85	0

Continued on next page...

Continued from previous page...

Mol	Chain	Analysed	<RSRZ>	#RSRZ>2	OWAB(Å ²)	Q<0.9
44	L7	222/243 (91%)	0.19	3 (1%) 75 75	40, 49, 73, 106	0
44	l7	223/243 (91%)	-0.05	1 (0%) 92 93	39, 49, 80, 107	0
45	L8	233/255 (91%)	0.94	41 (17%) 1 1	67, 81, 104, 112	0
45	l8	231/255 (90%)	1.04	42 (18%) 1 1	73, 84, 106, 114	0
46	L9	191/191 (100%)	0.21	9 (4%) 31 29	60, 70, 82, 93	0
46	l9	191/191 (100%)	0.08	1 (0%) 91 91	44, 55, 71, 81	0
47	M0	211/220 (95%)	1.08	40 (18%) 1 1	45, 63, 92, 106	0
47	m0	213/220 (96%)	0.96	28 (13%) 3 3	40, 55, 80, 90	0
48	M1	169/173 (97%)	1.03	25 (14%) 2 2	68, 84, 94, 98	0
48	m1	169/173 (97%)	0.38	5 (2%) 50 49	52, 67, 77, 82	0
49	M3	193/198 (97%)	0.40	8 (4%) 37 35	39, 64, 92, 113	0
49	m3	194/198 (97%)	0.77	29 (14%) 2 2	41, 69, 100, 111	0
50	M4	136/137 (99%)	-0.04	2 (1%) 73 72	54, 61, 73, 83	0
50	m4	137/137 (100%)	-0.04	1 (0%) 87 88	48, 54, 69, 82	0
51	M5	203/203 (100%)	0.27	3 (1%) 73 72	41, 56, 66, 69	0
51	m5	203/203 (100%)	0.47	10 (4%) 29 27	44, 60, 71, 76	0
52	M6	197/198 (99%)	0.27	4 (2%) 65 64	42, 49, 65, 68	0
52	m6	197/198 (99%)	0.08	2 (1%) 82 82	34, 42, 64, 66	0
53	M7	183/183 (100%)	0.87	23 (12%) 3 3	47, 55, 98, 116	0
53	m7	155/183 (84%)	0.17	0 100 100	39, 46, 59, 77	0
54	M8	185/185 (100%)	0.22	3 (1%) 72 70	43, 55, 69, 88	0
54	m8	185/185 (100%)	0.11	0 100 100	42, 57, 66, 70	0
55	M9	188/188 (100%)	0.55	19 (10%) 7 6	65, 77, 135, 140	0
55	m9	188/188 (100%)	0.49	12 (6%) 19 19	51, 65, 121, 134	0
56	N0	172/172 (100%)	0.18	4 (2%) 60 59	49, 57, 69, 74	0
56	n0	172/172 (100%)	0.02	1 (0%) 89 90	43, 49, 59, 66	0
57	N1	159/159 (100%)	0.44	4 (2%) 57 54	42, 56, 93, 101	0
57	n1	159/159 (100%)	0.57	11 (6%) 16 16	40, 49, 83, 87	0
58	N2	100/120 (83%)	1.06	25 (25%) 0 0	93, 104, 120, 122	0
58	n2	98/120 (81%)	1.04	21 (21%) 0 1	75, 88, 94, 97	0
59	N3	136/136 (100%)	0.67	11 (8%) 12 11	51, 60, 70, 74	0

Continued on next page...

Continued from previous page...

Mol	Chain	Analysed	<RSRZ>	#RSRZ>2	OWAB(Å ²)	Q<0.9
59	n3	136/136 (100%)	0.41	3 (2%) 62 60	36, 45, 55, 58	0
60	N4	98/155 (63%)	1.83	29 (29%) 0 0	62, 72, 134, 147	0
60	n4	135/155 (87%)	0.74	19 (14%) 2 2	46, 91, 115, 116	0
61	N5	121/141 (85%)	0.80	14 (11%) 4 4	58, 69, 84, 95	0
61	n5	120/141 (85%)	0.27	1 (0%) 86 86	56, 68, 85, 93	0
62	N6	126/126 (100%)	0.84	19 (15%) 2 2	50, 62, 74, 79	0
62	n6	126/126 (100%)	0.42	4 (3%) 47 46	51, 64, 77, 83	0
63	N7	135/135 (100%)	1.78	49 (36%) 0 0	82, 94, 103, 109	0
63	n7	135/135 (100%)	1.44	43 (31%) 0 0	76, 91, 102, 105	0
64	N8	148/148 (100%)	0.36	2 (1%) 75 75	35, 56, 74, 82	0
64	n8	148/148 (100%)	0.16	3 (2%) 65 64	34, 59, 74, 77	0
65	N9	58/58 (100%)	0.54	4 (6%) 16 16	38, 61, 95, 106	0
65	n9	58/58 (100%)	0.36	5 (8%) 10 10	38, 58, 78, 85	0
66	O0	97/104 (93%)	0.64	9 (9%) 8 9	81, 89, 101, 102	0
66	o0	100/104 (96%)	0.44	2 (2%) 65 64	75, 82, 102, 108	0
67	O1	109/112 (97%)	0.97	14 (12%) 3 3	61, 72, 91, 103	0
67	o1	109/112 (97%)	0.45	4 (3%) 41 38	47, 58, 81, 90	0
68	O2	127/129 (98%)	0.16	2 (1%) 72 70	36, 49, 62, 68	0
68	o2	127/129 (98%)	0.54	7 (5%) 25 23	35, 52, 63, 71	0
69	O3	106/106 (100%)	0.31	1 (0%) 84 84	42, 47, 71, 78	0
69	o3	106/106 (100%)	0.14	0 100 100	40, 46, 69, 75	0
70	O4	112/120 (93%)	0.60	7 (6%) 20 20	57, 75, 101, 107	0
70	o4	112/120 (93%)	0.66	8 (7%) 16 16	50, 68, 99, 103	0
71	O5	119/119 (100%)	0.32	6 (5%) 28 27	55, 70, 78, 82	0
71	o5	119/119 (100%)	0.59	8 (6%) 17 17	59, 71, 87, 96	0
72	O6	99/99 (100%)	0.63	5 (5%) 28 26	60, 68, 91, 102	0
72	o6	99/99 (100%)	0.39	4 (4%) 38 36	64, 72, 88, 103	0
73	O7	87/87 (100%)	0.13	1 (1%) 80 81	43, 50, 65, 71	0
73	o7	87/87 (100%)	0.21	2 (2%) 60 59	41, 50, 73, 84	0
74	O8	77/77 (100%)	0.86	8 (10%) 6 6	83, 93, 108, 113	0
74	o8	77/77 (100%)	1.51	25 (32%) 0 0	77, 86, 94, 98	0

Continued on next page...

Continued from previous page...

Mol	Chain	Analysed	<RSRZ>	#RSRZ>2	OWAB(Å ²)	Q<0.9
75	O9	50/50 (100%)	0.49	1 (2%) 65 64	52, 57, 59, 60	0
75	o9	50/50 (100%)	0.27	1 (2%) 65 64	50, 55, 63, 63	0
76	Q0	52/52 (100%)	0.86	7 (13%) 3 3	53, 59, 74, 79	0
76	q0	52/52 (100%)	0.37	1 (1%) 66 65	41, 45, 55, 58	0
77	Q1	25/25 (100%)	1.26	6 (24%) 0 0	62, 66, 73, 74	0
77	q1	25/25 (100%)	0.99	2 (8%) 12 11	50, 56, 58, 58	0
78	Q2	105/105 (100%)	0.12	2 (1%) 66 65	41, 56, 76, 91	0
78	q2	105/105 (100%)	0.26	1 (0%) 82 82	44, 56, 70, 93	0
79	Q3	91/91 (100%)	0.21	2 (2%) 62 60	54, 65, 80, 85	0
79	q3	91/91 (100%)	0.38	3 (3%) 46 44	46, 59, 72, 84	0
80	m2	0/165	-	-	-	-
81	p0	120/311 (38%)	1.27	32 (26%) 0 0	101, 124, 144, 152	0
82	p1	0/47	-	-	-	-
82	p2	0/47	-	-	-	-
83	f	148/157 (94%)	2.86	92 (62%) 0 0	55, 96, 150, 153	75 (50%)
84	B	2/5 (40%)	0.21	0 100 100	43, 43, 43, 44	0
84	C	2/5 (40%)	0.25	0 100 100	49, 49, 49, 49	0
All	All	33084/35503 (93%)	0.60	3313 (10%) 7 7	34, 74, 132, 212	75 (0%)

The worst 5 of 3313 RSRZ outliers are listed below:

Mol	Chain	Res	Type	RSRZ
60	N4	75	THR	13.9
1	2	1699	G	13.8
53	M7	161	ALA	12.0
1	2	1696	G	12.0
1	2	1697	G	11.7

6.2 Non-standard residues in protein, DNA, RNA chains [i](#)

In the following table, the Atoms column lists the number of modelled atoms in the group and the number defined in the chemical component dictionary. The B-factors column lists the minimum, median, 95th percentile and maximum values of B factors of atoms in the group. The column labelled 'Q< 0.9' lists the number of atoms with occupancy less than 0.9.

Continued on next page...

Continued from previous page...

Mol	Type	Chain	Res	Atoms	RSCC	RSR	B-factors(Å ²)	Q<0.9
84	CH	C	74	17/21	0.90	0.21	47,48,55,57	0
84	CH	B	75	20/21	0.95	0.22	44,44,50,51	0
84	CH	B	74	20/21	0.96	0.25	47,50,62,62	0
84	8AN	B	76	22/23	0.96	0.22	42,44,45,45	0
84	8AN	C	76	22/23	0.96	0.20	47,47,47,47	0
84	CH	C	75	20/21	0.98	0.16	46,47,51,51	0

6.3 Carbohydrates [i](#)

There are no monosaccharides in this entry.

6.4 Ligands [i](#)

In the following table, the Atoms column lists the number of modelled atoms in the group and the number defined in the chemical component dictionary. The B-factors column lists the minimum, median, 95th percentile and maximum values of B factors of atoms in the group. The column labelled 'Q< 0.9' lists the number of atoms with occupancy less than 0.9.

Mol	Type	Chain	Res	Atoms	RSCC	RSR	B-factors(Å ²)	Q<0.9
85	ZN	e1	501	1/1	0.79	0.08	164,164,164,164	0
85	ZN	D7	101	1/1	0.81	0.21	141,141,141,141	0
85	ZN	d7	101	1/1	0.82	0.16	131,131,131,131	0
87	MG	5	3402	1/1	0.84	0.36	45,45,45,45	0
87	MG	1	3403	1/1	0.89	0.38	45,45,45,45	0
85	ZN	Q2	501	1/1	0.91	0.05	76,76,76,76	0
87	MG	1	3402	1/1	0.93	0.65	21,21,21,21	0
87	MG	f	1002	1/1	0.93	0.08	66,66,66,66	0
87	MG	1	3404	1/1	0.94	0.65	29,29,29,29	0
85	ZN	D6	500	1/1	0.94	0.07	105,105,105,105	0
86	SPS	1	3401	23/23	0.94	0.24	40,43,57,59	0
87	MG	C	101	1/1	0.94	0.31	49,49,49,49	0
87	MG	5	3405	1/1	0.95	0.74	42,42,42,42	0
87	MG	5	3401	1/1	0.95	0.38	41,41,41,41	0
87	MG	5	3404	1/1	0.95	0.48	36,36,36,36	0
87	MG	B	3402	1/1	0.96	0.32	40,40,40,40	0
86	SPS	B	3401	23/23	0.96	0.31	37,40,54,56	0
87	MG	f	1001	1/1	0.97	0.33	52,52,52,52	0
85	ZN	E1	501	1/1	0.97	0.05	136,136,136,136	0
85	ZN	d6	500	1/1	0.97	0.06	87,87,87,87	0

Continued on next page...

Continued from previous page...

Mol	Type	Chain	Res	Atoms	RSCC	RSR	B-factors(\AA^2)	Q<0.9
85	ZN	q2	501	1/1	0.97	0.05	77,77,77,77	0
85	ZN	D9	101	1/1	0.98	0.08	88,88,88,88	0
87	MG	5	3403	1/1	0.98	0.55	23,23,23,23	0
85	ZN	Q3	501	1/1	0.98	0.11	77,77,77,77	0
85	ZN	Q0	500	1/1	0.98	0.10	57,57,57,57	0
88	OHX	1	3405	7/7	0.98	0.09	91,91,91,91	0
88	OHX	5	3406	7/7	0.98	0.09	95,95,95,95	0
85	ZN	O7	100	1/1	0.99	0.14	52,52,52,52	0
85	ZN	o7	501	1/1	0.99	0.21	51,51,51,51	0
85	ZN	q0	500	1/1	0.99	0.13	42,42,42,42	0
88	OHX	1	3406	7/7	0.99	0.14	73,73,73,73	0
85	ZN	d9	101	1/1	0.99	0.09	94,94,94,94	0
85	ZN	q3	501	1/1	1.00	0.17	69,69,69,69	0

6.5 Other polymers [i](#)

There are no such residues in this entry.