



Full wwPDB X-ray Structure Validation Report ⓘ

Aug 23, 2023 – 11:36 AM EDT

PDB ID : 3DFO
Title : Dihydroxyacetone phosphate Schiff base and enamine intermediates in D33N mutant fructose-1,6-bisphosphate aldolase from rabbit muscle
Authors : St-Jean, M.; Sygusch, J.
Deposited on : 2008-06-12
Resolution : 1.94 Å(reported)

This is a Full wwPDB X-ray Structure Validation Report for a publicly released PDB entry.

We welcome your comments at validation@mail.wwpdb.org

A user guide is available at

<https://www.wwpdb.org/validation/2017/XrayValidationReportHelp>

with specific help available everywhere you see the ⓘ symbol.

The types of validation reports are described at

<http://www.wwpdb.org/validation/2017/FAQs#types>.

The following versions of software and data (see [references ⓘ](#)) were used in the production of this report:

MolProbity : 4.02b-467
Mogul : 1.8.5 (274361), CSD as541be (2020)
Xtriage (Phenix) : 1.13
EDS : 2.35
Percentile statistics : 20191225.v01 (using entries in the PDB archive December 25th 2019)
Refmac : 5.8.0158
CCP4 : 7.0.044 (Gargrove)
Ideal geometry (proteins) : Engh & Huber (2001)
Ideal geometry (DNA, RNA) : Parkinson et al. (1996)
Validation Pipeline (wwPDB-VP) : 2.35

1 Overall quality at a glance i

The following experimental techniques were used to determine the structure:

X-RAY DIFFRACTION

The reported resolution of this entry is 1.94 Å.

Percentile scores (ranging between 0-100) for global validation metrics of the entry are shown in the following graphic. The table shows the number of entries on which the scores are based.

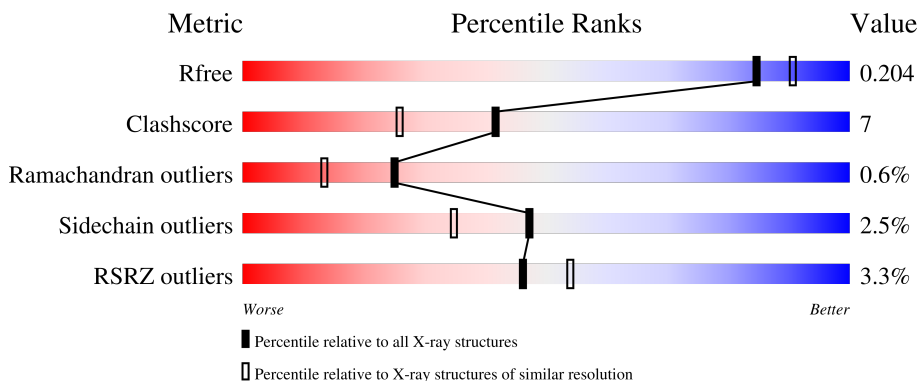

Metric	Whole archive (#Entries)	Similar resolution (#Entries, resolution range(Å))
R_{free}	130704	4310 (1.96-1.92)
Clashscore	141614	1023 (1.94-1.94)
Ramachandran outliers	138981	1007 (1.94-1.94)
Sidechain outliers	138945	1007 (1.94-1.94)
RSRZ outliers	127900	4250 (1.96-1.92)

The table below summarises the geometric issues observed across the polymeric chains and their fit to the electron density. The red, orange, yellow and green segments of the lower bar indicate the fraction of residues that contain outliers for ≥ 3 , 2, 1 and 0 types of geometric quality criteria respectively. A grey segment represents the fraction of residues that are not modelled. The numeric value for each fraction is indicated below the corresponding segment, with a dot representing fractions $\leq 5\%$. The upper red bar (where present) indicates the fraction of residues that have poor fit to the electron density. The numeric value is given above the bar.

Mol	Chain	Length	Quality of chain
1	A	363	80% 16% .
1	B	363	80% 15% . .
1	C	363	83% 12% . .
1	D	363	80% 18% . .

2 Entry composition

There are 3 unique types of molecules in this entry. The entry contains 12895 atoms, of which 0 are hydrogens and 0 are deuteriums.

In the tables below, the ZeroOcc column contains the number of atoms modelled with zero occupancy, the AltConf column contains the number of residues with at least one atom in alternate conformation and the Trace column contains the number of residues modelled with at most 2 atoms.

- Molecule 1 is a protein called Fructose-bisphosphate aldolase A.

Mol	Chain	Residues	Atoms					ZeroOcc	AltConf	Trace
			Total	C	N	O	S			
1	A	350	2682	1686	478	507	11	0	1	0
1	B	350	2682	1686	478	507	11	0	1	0
1	C	351	2677	1682	477	507	11	0	0	0
1	D	360	2739	1721	487	520	11	0	1	0

There are 4 discrepancies between the modelled and reference sequences:

Chain	Residue	Modelled	Actual	Comment	Reference
A	33	ASN	ASP	engineered mutation	UNP P00883
B	33	ASN	ASP	engineered mutation	UNP P00883
C	33	ASN	ASP	engineered mutation	UNP P00883
D	33	ASN	ASP	engineered mutation	UNP P00883

- Molecule 2 is 1,3-DIHYDROXYACETONEPHOSPHATE (three-letter code: 13P) (formula: C₃H₇O₆P).

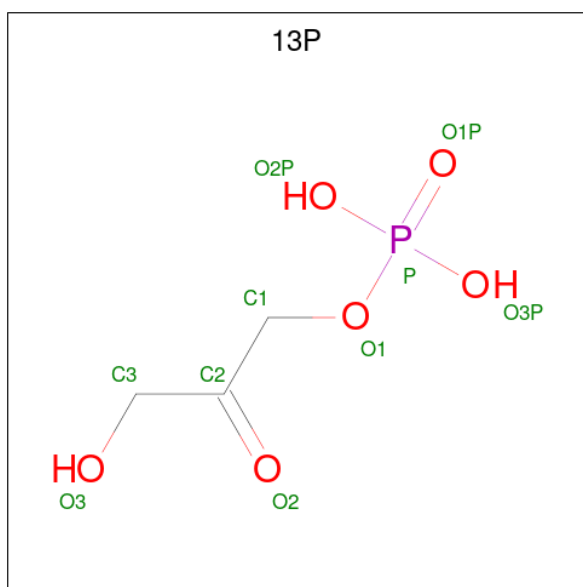

Mol	Chain	Residues	Atoms				ZeroOcc	AltConf
2	A	1	Total	C	O	P	0	0
			9	3	5	1		
2	B	1	Total	C	O	P	0	0
			9	3	5	1		
2	C	1	Total	C	O	P	0	0
			9	3	5	1		
2	D	1	Total	C	O	P	0	0
			9	3	5	1		

- Molecule 3 is water.

Mol	Chain	Residues	Atoms		ZeroOcc	AltConf
3	A	541	Total	O	0	0
			541	541		
3	B	500	Total	O	0	0
			500	500		
3	C	532	Total	O	0	0
			532	532		
3	D	506	Total	O	0	0
			506	506		

3 Residue-property plots [i](#)

These plots are drawn for all protein, RNA, DNA and oligosaccharide chains in the entry. The first graphic for a chain summarises the proportions of the various outlier classes displayed in the second graphic. The second graphic shows the sequence view annotated by issues in geometry and electron density. Residues are color-coded according to the number of geometric quality criteria for which they contain at least one outlier: green = 0, yellow = 1, orange = 2 and red = 3 or more. A red dot above a residue indicates a poor fit to the electron density ($RSRZ > 2$). Stretches of 2 or more consecutive residues without any outlier are shown as a green connector. Residues present in the sample, but not in the model, are shown in grey.

- Molecule 1: Fructose-bisphosphate aldolase A

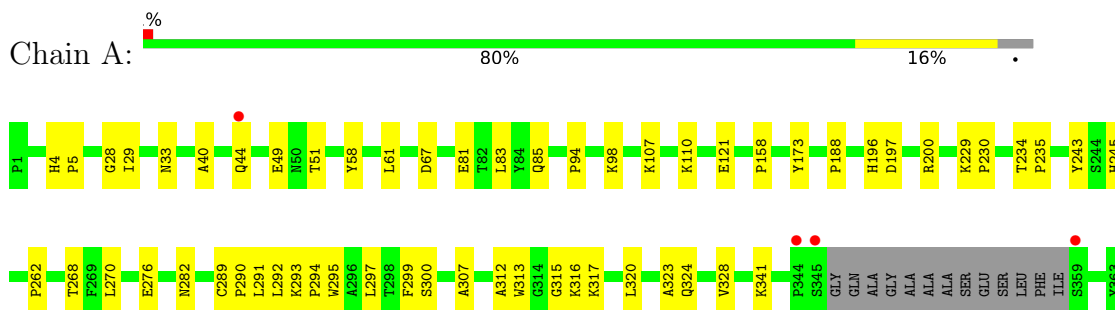

- Molecule 1: Fructose-bisphosphate aldolase A

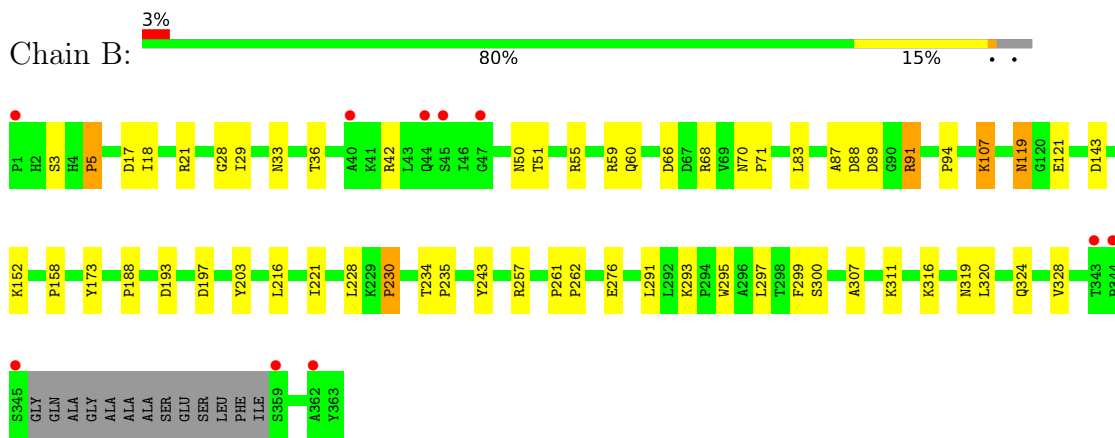

- Molecule 1: Fructose-bisphosphate aldolase A

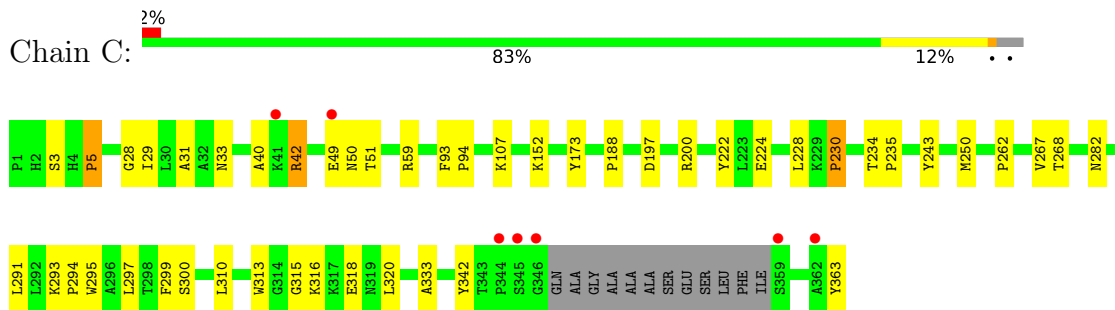

- Molecule 1: Fructose-bisphosphate aldolase A

Chain D:  7% 80% 18% ..

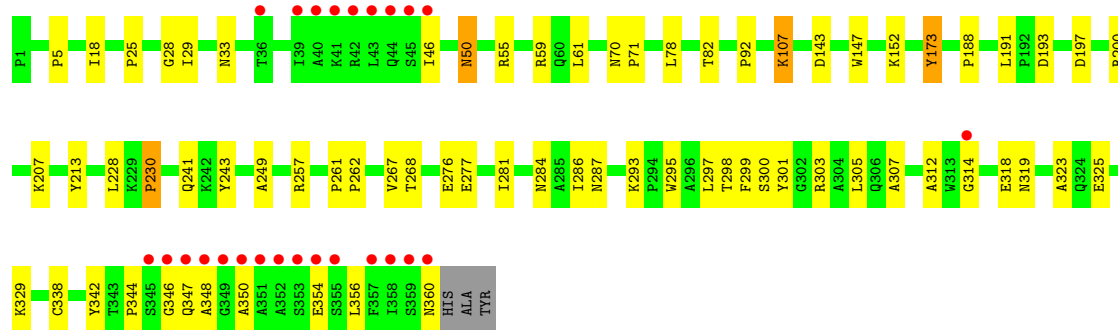

4 Data and refinement statistics

Property	Value	Source
Space group	P 1 21 1	Depositor
Cell constants a, b, c, α , β , γ	83.68Å 103.13Å 84.56Å 90.00° 98.71° 90.00°	Depositor
Resolution (Å)	43.76 – 1.94 43.76 – 1.80	Depositor EDS
% Data completeness (in resolution range)	85.5 (43.76-1.94) 83.4 (43.76-1.80)	Depositor EDS
R_{merge}	(Not available)	Depositor
R_{sym}	0.08	Depositor
$\langle I/\sigma(I) \rangle$ ¹	1.22 (at 1.79Å)	Xtrriage
Refinement program	CNS	Depositor
R, R_{free}	0.152 , 0.199 0.159 , 0.204	Depositor DCC
R_{free} test set	11803 reflections (10.00%)	wwPDB-VP
Wilson B-factor (Å ²)	15.9	Xtrriage
Anisotropy	0.672	Xtrriage
Bulk solvent k_{sol} (e/Å ³), B_{sol} (Å ²)	0.33 , 63.9	EDS
L-test for twinning ²	$\langle L \rangle = 0.49$, $\langle L^2 \rangle = 0.32$	Xtrriage
Estimated twinning fraction	0.017 for l,-k,h	Xtrriage
F_o, F_c correlation	0.96	EDS
Total number of atoms	12895	wwPDB-VP
Average B, all atoms (Å ²)	25.0	wwPDB-VP

Xtrriage's analysis on translational NCS is as follows: *The largest off-origin peak in the Patterson function is 5.61% of the height of the origin peak. No significant pseudotranslation is detected.*

¹Intensities estimated from amplitudes.

²Theoretical values of $\langle |L| \rangle$, $\langle L^2 \rangle$ for acentric reflections are 0.5, 0.333 respectively for untwinned datasets, and 0.375, 0.2 for perfectly twinned datasets.

5 Model quality

5.1 Standard geometry

Bond lengths and bond angles in the following residue types are not validated in this section: 13P

The Z score for a bond length (or angle) is the number of standard deviations the observed value is removed from the expected value. A bond length (or angle) with $|Z| > 5$ is considered an outlier worth inspection. RMSZ is the root-mean-square of all Z scores of the bond lengths (or angles).

Mol	Chain	Bond lengths		Bond angles	
		RMSZ	# Z >5	RMSZ	# Z >5
1	A	0.28	0/2734	0.57	0/3702
1	B	0.29	0/2734	0.58	0/3702
1	C	0.29	0/2729	0.57	0/3696
1	D	0.28	0/2791	0.56	0/3781
All	All	0.29	0/10988	0.57	0/14881

Chiral center outliers are detected by calculating the chiral volume of a chiral center and verifying if the center is modelled as a planar moiety or with the opposite hand. A planarity outlier is detected by checking planarity of atoms in a peptide group, atoms in a mainchain group or atoms of a sidechain that are expected to be planar.

Mol	Chain	#Chirality outliers	#Planarity outliers
1	D	0	1

There are no bond length outliers.

There are no bond angle outliers.

There are no chirality outliers.

All (1) planarity outliers are listed below:

Mol	Chain	Res	Type	Group
1	D	213	TYR	Sidechain

5.2 Too-close contacts

In the following table, the Non-H and H(model) columns list the number of non-hydrogen atoms and hydrogen atoms in the chain respectively. The H(added) column lists the number of hydrogen atoms added and optimized by MolProbity. The Clashes column lists the number of clashes within the asymmetric unit, whereas Symm-Clashes lists symmetry-related clashes.

Mol	Chain	Non-H	H(model)	H(added)	Clashes	Symm-Clashes
1	A	2682	0	2705	42	0
1	B	2682	0	2706	42	0
1	C	2677	0	2696	30	0
1	D	2739	0	2767	45	0
2	A	9	0	5	1	0
2	B	9	0	5	0	0
2	C	9	0	5	1	0
2	D	9	0	5	0	0
3	A	541	0	0	5	0
3	B	500	0	0	5	0
3	C	532	0	0	2	0
3	D	506	0	0	8	0
All	All	12895	0	10894	151	0

The all-atom clashscore is defined as the number of clashes found per 1000 atoms (including hydrogen atoms). The all-atom clashscore for this structure is 7.

All (151) close contacts within the same asymmetric unit are listed below, sorted by their clash magnitude.

Atom-1	Atom-2	Interatomic distance (Å)	Clash overlap (Å)
1:B:60:GLN:NE2	1:B:88:ASP:H	1.76	0.82
1:C:49:GLU:HG2	1:C:51:THR:HG23	1.72	0.72
1:D:191:LEU:HD13	1:D:360:ASN:ND2	2.04	0.72
1:D:325:GLU:HG3	1:D:329:LYS:HE3	1.72	0.71
1:A:200:ARG:HD2	3:D:3263:HOH:O	1.92	0.69
1:B:33:ASN:HD22	1:B:107[B]:LYS:NZ	1.91	0.69
1:D:348:ALA:HB3	3:D:3222:HOH:O	1.92	0.69
1:D:284:ASN:ND2	1:D:342:TYR:H	1.94	0.66
1:B:293:LYS:HG2	1:B:297:LEU:HD11	1.77	0.66
1:B:228:LEU:HG	1:B:230:PRO:HD3	1.78	0.66
1:A:293:LYS:HG2	1:A:297:LEU:HD11	1.80	0.64
1:D:70:ASN:HB2	1:D:71:PRO:HD3	1.80	0.63
1:B:311:LYS:HD2	3:B:3385:HOH:O	1.99	0.61
1:D:152:LYS:HE2	3:D:3317:HOH:O	2.02	0.60
1:B:60:GLN:HE22	1:B:88:ASP:H	1.45	0.60
1:A:110:LYS:HE3	3:B:3614:HOH:O	2.02	0.59
1:C:228:LEU:HG	1:C:230:PRO:HD3	1.85	0.58
1:B:33:ASN:HD22	1:B:107[B]:LYS:HZ3	1.50	0.58
1:B:28:GLY:HA3	1:B:299:PHE:CZ	2.40	0.57
1:C:42:ARG:HD3	3:C:3664:HOH:O	2.03	0.57
1:A:107[A]:LYS:HD2	3:A:3002:HOH:O	2.05	0.56
1:C:197:ASP:HB2	1:C:243:TYR:OH	2.04	0.56

Continued on next page...

Continued from previous page...

Atom-1	Atom-2	Interatomic distance (Å)	Clash overlap (Å)
1:D:50:ASN:ND2	1:D:55:ARG:HH11	2.05	0.55
1:A:33:ASN:HD22	1:A:107[B]:LYS:NZ	2.03	0.55
1:B:291:LEU:O	1:B:293:LYS:HD3	2.05	0.55
1:B:70:ASN:HB2	1:B:71:PRO:HD3	1.88	0.55
1:B:18:ILE:HD13	1:B:143:ASP:HB3	1.89	0.54
1:D:92:PRO:HB3	3:D:3339:HOH:O	2.08	0.54
1:A:49:GLU:HG2	1:A:51:THR:HG23	1.90	0.53
1:C:318:GLU:H	1:C:318:GLU:CD	2.09	0.53
1:B:257:ARG:HA	1:C:262:PRO:HG2	1.90	0.53
1:B:33:ASN:ND2	1:B:107[B]:LYS:HZ3	2.06	0.53
1:D:28:GLY:HA3	1:D:299:PHE:CZ	2.43	0.53
1:A:320:LEU:O	1:A:324:GLN:HG3	2.09	0.53
1:B:197:ASP:HB2	1:B:243:TYR:OH	2.10	0.52
1:D:228:LEU:HG	1:D:230:PRO:HD3	1.91	0.52
1:B:60:GLN:HE21	1:B:87:ALA:HA	1.75	0.52
1:C:28:GLY:HA3	1:C:299:PHE:CE1	2.44	0.52
1:B:89:ASP:OD1	1:B:91:ARG:HB2	2.10	0.52
1:B:28:GLY:HA3	1:B:299:PHE:CE1	2.44	0.52
1:B:60:GLN:NE2	1:B:88:ASP:N	2.52	0.52
1:B:83:LEU:HD12	1:B:94:PRO:HG3	1.92	0.51
1:C:152:LYS:HE2	3:C:3663:HOH:O	2.10	0.51
1:B:36:THR:HG23	1:B:50:ASN:HD21	1.75	0.51
1:B:152:LYS:HE2	3:B:3375:HOH:O	2.11	0.50
1:A:83:LEU:HD12	1:A:94:PRO:HG3	1.93	0.50
1:D:350:ALA:O	1:D:354:GLU:HG3	2.11	0.50
1:A:268:THR:HB	1:A:300:SER:HB2	1.94	0.50
1:C:234:THR:HB	1:C:235:PRO:HD2	1.93	0.50
1:A:28:GLY:HA3	1:A:299:PHE:CZ	2.47	0.49
1:B:262:PRO:CG	1:C:294:PRO:HG3	2.43	0.49
1:C:93:PHE:N	1:C:94:PRO:HD2	2.27	0.49
1:C:40:ALA:HA	1:C:50:ASN:ND2	2.27	0.49
1:B:276:GLU:CD	1:B:307:ALA:HB3	2.34	0.48
1:A:341:LYS:HE2	3:A:3099:HOH:O	2.13	0.48
3:B:3280:HOH:O	1:C:200:ARG:HD2	2.14	0.48
1:A:40:ALA:O	1:A:44:GLN:HG3	2.13	0.48
1:D:50:ASN:HD21	1:D:55:ARG:HH11	1.62	0.48
1:B:324:GLN:O	1:B:328:VAL:HG23	2.14	0.48
1:D:325:GLU:O	1:D:329:LYS:HG3	2.13	0.47
1:D:276:GLU:CD	1:D:307:ALA:HB3	2.34	0.47
1:A:291:LEU:O	1:A:293:LYS:HD3	2.14	0.47
1:D:298:THR:OG1	1:D:299:PHE:N	2.47	0.47

Continued on next page...

Continued from previous page...

Atom-1	Atom-2	Interatomic distance (Å)	Clash overlap (Å)
1:C:291:LEU:O	1:C:293:LYS:HE2	2.14	0.47
1:C:28:GLY:HA3	1:C:299:PHE:CZ	2.49	0.47
1:C:29:ILE:HB	1:C:300:SER:HA	1.96	0.47
1:C:313:TRP:CE2	1:C:315:GLY:HA2	2.50	0.47
1:D:287:ASN:ND2	1:D:338:CYS:HA	2.31	0.47
1:A:81:GLU:O	1:A:85:GLN:HG3	2.15	0.46
1:D:267:VAL:HB	1:D:297:LEU:HD23	1.97	0.46
1:B:29:ILE:HB	1:B:300:SER:HA	1.97	0.46
1:A:312:ALA:HB3	1:A:323:ALA:HA	1.97	0.46
1:A:324:GLN:O	1:A:328:VAL:HG23	2.15	0.46
1:A:61:LEU:HD11	1:A:323:ALA:HB3	1.96	0.46
1:A:317:LYS:HG3	3:A:3299:HOH:O	2.16	0.46
1:A:4:HIS:CD2	1:B:119:ASN:HB2	2.51	0.46
1:C:267:VAL:HB	1:C:297:LEU:HD23	1.98	0.45
1:D:25:PRO:HG2	3:D:3055:HOH:O	2.16	0.45
1:D:318:GLU:HG2	1:D:319:ASN:OD1	2.17	0.45
1:D:46:ILE:HB	1:D:314:GLY:HA2	1.98	0.45
1:D:301:TYR:HB2	1:D:305:LEU:HG	1.97	0.45
1:C:250:MET:HG2	1:C:363:TYR:CE2	2.51	0.45
1:A:316:LYS:HE3	3:A:3175:HOH:O	2.16	0.45
1:C:268:THR:HB	1:C:300:SER:HB2	1.99	0.45
1:D:293:LYS:HD3	1:D:297:LEU:CD1	2.47	0.45
1:D:33:ASN:HD22	1:D:107[A]:LYS:HG3	1.82	0.44
1:D:61:LEU:HD11	1:D:323:ALA:HB3	1.99	0.44
1:D:78:LEU:HD22	1:D:82:THR:HG21	1.99	0.44
1:B:234:THR:HB	1:B:235:PRO:HD2	1.99	0.44
1:D:29:ILE:HB	1:D:300:SER:HA	1.98	0.44
1:A:29:ILE:HB	1:A:300:SER:HA	1.97	0.44
1:B:320:LEU:O	1:B:324:GLN:HG3	2.17	0.44
1:A:276:GLU:CD	1:A:307:ALA:HB3	2.38	0.44
1:D:268:THR:HB	1:D:300:SER:HB2	2.00	0.44
1:A:58:TYR:O	1:A:61:LEU:HB3	2.18	0.44
1:A:121:GLU:OE2	1:A:158:PRO:HA	2.18	0.44
1:A:196:HIS:HB2	1:A:200:ARG:HG2	2.00	0.44
1:A:245:HIS:HD2	1:A:282:ASN:OD1	2.01	0.44
1:C:293:LYS:HD2	1:C:297:LEU:CD1	2.48	0.44
1:B:216:LEU:HD22	1:B:221:ILE:HG13	2.00	0.43
1:C:31:ALA:HB1	2:C:3003:13P:H31	1.99	0.43
1:A:262:PRO:HG3	1:D:262:PRO:HG3	2.00	0.43
1:C:333:ALA:HB1	1:C:342:TYR:CE1	2.54	0.43
1:A:229:LYS:HE2	1:A:270:LEU:HB3	2.00	0.43

Continued on next page...

Continued from previous page...

Atom-1	Atom-2	Interatomic distance (Å)	Clash overlap (Å)
1:B:42:ARG:HH11	1:B:42:ARG:HG2	1.84	0.43
1:B:66:ASP:OD1	1:B:68:ARG:HB2	2.18	0.43
1:B:51:THR:O	1:B:55:ARG:HG3	2.19	0.43
1:B:203:TYR:CD1	1:C:3:SER:HB2	2.53	0.43
1:D:241:GLN:NE2	3:D:3305:HOH:O	2.51	0.43
1:A:28:GLY:HA3	1:A:299:PHE:CE1	2.54	0.43
1:D:207:LYS:HE2	3:D:3454:HOH:O	2.17	0.43
1:D:249:ALA:HB1	1:D:286:ILE:HA	2.00	0.43
1:A:33:ASN:ND2	1:A:107[B]:LYS:NZ	2.66	0.43
1:A:292:LEU:HD23	1:A:292:LEU:C	2.39	0.42
1:B:121:GLU:OE2	1:B:158:PRO:HA	2.19	0.42
1:B:316:LYS:HB2	1:B:319:ASN:ND2	2.33	0.42
1:B:60:GLN:HE22	1:B:88:ASP:N	2.14	0.42
1:D:277:GLU:OE2	1:D:344:PRO:HB3	2.18	0.42
1:A:300:SER:O	2:A:3001:13P:H12	2.18	0.42
1:C:33:ASN:HD22	1:C:107:LYS:HG3	1.84	0.42
1:B:3:SER:HB3	3:B:3692:HOH:O	2.20	0.42
1:C:42:ARG:HG2	1:C:310:LEU:HD22	2.02	0.42
1:C:293:LYS:HD2	1:C:297:LEU:HD12	2.01	0.42
1:A:33:ASN:HD22	1:A:107[B]:LYS:HZ1	1.68	0.42
1:D:18:ILE:HD13	1:D:143:ASP:HB3	2.02	0.41
1:A:289:CYS:HA	1:A:290:PRO:HD3	1.90	0.41
1:D:303:ARG:HB3	1:D:356:LEU:HD13	2.02	0.41
1:A:98:LYS:NZ	3:A:3262:HOH:O	2.53	0.41
1:A:33:ASN:ND2	1:A:107[B]:LYS:HZ1	2.19	0.41
1:A:262:PRO:HD2	1:D:257:ARG:O	2.21	0.41
1:D:261:PRO:HA	1:D:262:PRO:HD3	1.93	0.41
1:A:197:ASP:HB2	1:A:243:TYR:OH	2.20	0.41
1:B:36:THR:CG2	1:B:50:ASN:HD21	2.33	0.41
1:D:200:ARG:HG2	1:D:200:ARG:HH11	1.85	0.41
1:D:312:ALA:HB3	1:D:323:ALA:HA	2.02	0.41
1:A:4:HIS:NE2	1:B:119:ASN:HB2	2.35	0.41
1:B:17:ASP:O	1:B:21:ARG:HG3	2.21	0.41
1:D:61:LEU:HD11	1:D:323:ALA:CB	2.50	0.41
1:D:197:ASP:HB2	1:D:243:TYR:OH	2.21	0.41
1:A:294:PRO:HG3	1:D:262:PRO:CG	2.51	0.41
1:B:60:GLN:HE21	1:B:87:ALA:CA	2.33	0.41
1:D:277:GLU:O	1:D:281:ILE:HG13	2.21	0.41
1:A:313:TRP:CE2	1:A:315:GLY:HA2	2.56	0.40
1:C:282:ASN:HD22	1:C:282:ASN:HA	1.66	0.40
1:B:261:PRO:HA	1:B:262:PRO:HD3	1.94	0.40

Continued on next page...

Continued from previous page...

Atom-1	Atom-2	Interatomic distance (Å)	Clash overlap (Å)
1:C:222:TYR:CZ	1:C:224:GLU:HB2	2.56	0.40
1:A:234:THR:HB	1:A:235:PRO:HD2	2.04	0.40
1:C:316:LYS:HB3	1:C:318:GLU:OE1	2.22	0.40
1:D:61:LEU:C	1:D:61:LEU:HD23	2.41	0.40
1:D:147:TRP:HB3	1:D:173:TYR:CE2	2.56	0.40
1:D:319:ASN:HA	3:D:3129:HOH:O	2.22	0.40

There are no symmetry-related clashes.

5.3 Torsion angles [i](#)

5.3.1 Protein backbone [i](#)

In the following table, the Percentiles column shows the percent Ramachandran outliers of the chain as a percentile score with respect to all X-ray entries followed by that with respect to entries of similar resolution.

The Analysed column shows the number of residues for which the backbone conformation was analysed, and the total number of residues.

Mol	Chain	Analysed	Favoured	Allowed	Outliers	Percentiles	
1	A	347/363 (96%)	336 (97%)	9 (3%)	2 (1%)	25	13
1	B	347/363 (96%)	332 (96%)	13 (4%)	2 (1%)	25	13
1	C	347/363 (96%)	335 (96%)	10 (3%)	2 (1%)	25	13
1	D	359/363 (99%)	344 (96%)	12 (3%)	3 (1%)	19	9
All	All	1400/1452 (96%)	1347 (96%)	44 (3%)	9 (1%)	25	13

All (9) Ramachandran outliers are listed below:

Mol	Chain	Res	Type
1	A	5	PRO
1	B	5	PRO
1	C	5	PRO
1	A	188	PRO
1	B	188	PRO
1	D	188	PRO
1	C	188	PRO
1	D	5	PRO
1	D	346	GLY

5.3.2 Protein sidechains [i](#)

In the following table, the Percentiles column shows the percent sidechain outliers of the chain as a percentile score with respect to all X-ray entries followed by that with respect to entries of similar resolution.

The Analysed column shows the number of residues for which the sidechain conformation was analysed, and the total number of residues.

Mol	Chain	Analysed	Rotameric	Outliers	Percentiles	
1	A	285/291 (98%)	281 (99%)	4 (1%)	67	58
1	B	285/291 (98%)	275 (96%)	10 (4%)	36	21
1	C	284/291 (98%)	277 (98%)	7 (2%)	47	35
1	D	290/291 (100%)	281 (97%)	9 (3%)	40	26
All	All	1144/1164 (98%)	1114 (97%)	30 (3%)	47	32

All (30) residues with a non-rotameric sidechain are listed below:

Mol	Chain	Res	Type
1	A	67	ASP
1	A	173	TYR
1	A	230	PRO
1	A	295	TRP
1	B	5	PRO
1	B	59	ARG
1	B	91	ARG
1	B	107[A]	LYS
1	B	107[B]	LYS
1	B	119	ASN
1	B	173	TYR
1	B	193	ASP
1	B	230	PRO
1	B	295	TRP
1	C	5	PRO
1	C	42	ARG
1	C	59	ARG
1	C	173	TYR
1	C	230	PRO
1	C	295	TRP
1	C	320	LEU
1	D	50	ASN
1	D	59	ARG
1	D	107[A]	LYS

Continued on next page...

Continued from previous page...

Mol	Chain	Res	Type
1	D	107[B]	LYS
1	D	173	TYR
1	D	193	ASP
1	D	230	PRO
1	D	295	TRP
1	D	347	GLN

Sometimes sidechains can be flipped to improve hydrogen bonding and reduce clashes. All (22) such sidechains are listed below:

Mol	Chain	Res	Type
1	A	33	ASN
1	A	119	ASN
1	A	180	ASN
1	A	241	GLN
1	A	245	HIS
1	A	319	ASN
1	B	33	ASN
1	B	54	ASN
1	B	60	GLN
1	B	95	GLN
1	B	119	ASN
1	B	319	ASN
1	C	54	ASN
1	C	241	GLN
1	C	282	ASN
1	C	319	ASN
1	D	44	GLN
1	D	50	ASN
1	D	180	ASN
1	D	241	GLN
1	D	284	ASN
1	D	360	ASN

5.3.3 RNA [i](#)

There are no RNA molecules in this entry.

5.4 Non-standard residues in protein, DNA, RNA chains [i](#)

There are no non-standard protein/DNA/RNA residues in this entry.

5.5 Carbohydrates [i](#)

There are no monosaccharides in this entry.

5.6 Ligand geometry [i](#)

4 ligands are modelled in this entry.

In the following table, the Counts columns list the number of bonds (or angles) for which Mogul statistics could be retrieved, the number of bonds (or angles) that are observed in the model and the number of bonds (or angles) that are defined in the Chemical Component Dictionary. The Link column lists molecule types, if any, to which the group is linked. The Z score for a bond length (or angle) is the number of standard deviations the observed value is removed from the expected value. A bond length (or angle) with $|Z| > 2$ is considered an outlier worth inspection. RMSZ is the root-mean-square of all Z scores of the bond lengths (or angles).

Mol	Type	Chain	Res	Link	Bond lengths			Bond angles		
					Counts	RMSZ	# Z > 2	Counts	RMSZ	# Z > 2
2	13P	D	3004	1	8,8,9	1.18	1 (12%)	10,10,12	1.12	1 (10%)
2	13P	B	3002	1	8,8,9	1.15	1 (12%)	10,10,12	1.14	1 (10%)
2	13P	C	3003	1	8,8,9	0.72	0	10,10,12	0.99	1 (10%)
2	13P	A	3001	1	8,8,9	0.71	0	10,10,12	0.99	1 (10%)

In the following table, the Chirals column lists the number of chiral outliers, the number of chiral centers analysed, the number of these observed in the model and the number defined in the Chemical Component Dictionary. Similar counts are reported in the Torsion and Rings columns. '-' means no outliers of that kind were identified.

Mol	Type	Chain	Res	Link	Chirals	Torsions	Rings
2	13P	D	3004	1	-	1/6/6/8	-
2	13P	B	3002	1	-	1/6/6/8	-
2	13P	C	3003	1	-	1/6/6/8	-
2	13P	A	3001	1	-	1/6/6/8	-

All (2) bond length outliers are listed below:

Mol	Chain	Res	Type	Atoms	Z	Observed(Å)	Ideal(Å)
2	D	3004	13P	C2-C3	-2.75	1.35	1.50
2	B	3002	13P	C2-C3	-2.74	1.35	1.50

All (4) bond angle outliers are listed below:

Mol	Chain	Res	Type	Atoms	Z	Observed(°)	Ideal(°)
2	B	3002	13P	C1-C2-C3	3.18	120.87	113.95
2	D	3004	13P	C1-C2-C3	3.14	120.78	113.95
2	C	3003	13P	C1-C2-C3	2.94	120.35	113.95
2	A	3001	13P	C1-C2-C3	2.86	120.19	113.95

There are no chirality outliers.

All (4) torsion outliers are listed below:

Mol	Chain	Res	Type	Atoms
2	B	3002	13P	O1-C1-C2-C3
2	C	3003	13P	O1-C1-C2-C3
2	D	3004	13P	O1-C1-C2-C3
2	A	3001	13P	O1-C1-C2-C3

There are no ring outliers.

2 monomers are involved in 2 short contacts:

Mol	Chain	Res	Type	Clashes	Symm-Clashes
2	C	3003	13P	1	0
2	A	3001	13P	1	0

5.7 Other polymers [i](#)

There are no such residues in this entry.

5.8 Polymer linkage issues [i](#)

There are no chain breaks in this entry.

6 Fit of model and data

6.1 Protein, DNA and RNA chains

In the following table, the column labelled ‘#RSRZ > 2’ contains the number (and percentage) of RSRZ outliers, followed by percent RSRZ outliers for the chain as percentile scores relative to all X-ray entries and entries of similar resolution. The OWAB column contains the minimum, median, 95th percentile and maximum values of the occupancy-weighted average B-factor per residue. The column labelled ‘Q < 0.9’ lists the number of (and percentage) of residues with an average occupancy less than 0.9.

Mol	Chain	Analysed	<RSRZ>	#RSRZ>2	OWAB(Å ²)	Q<0.9
1	A	350/363 (96%)	-0.19	4 (1%) 80 84	9, 18, 42, 56	2 (0%)
1	B	350/363 (96%)	-0.13	10 (2%) 51 59	8, 18, 43, 62	2 (0%)
1	C	351/363 (96%)	-0.11	7 (1%) 65 71	9, 18, 42, 62	2 (0%)
1	D	360/363 (99%)	0.11	25 (6%) 16 23	9, 21, 58, 88	0
All	All	1411/1452 (97%)	-0.08	46 (3%) 46 54	8, 19, 46, 88	6 (0%)

All (46) RSRZ outliers are listed below:

Mol	Chain	Res	Type	RSRZ
1	B	345	SER	9.0
1	A	345	SER	8.4
1	D	345	SER	8.1
1	D	358	ILE	5.4
1	D	348	ALA	4.9
1	D	40	ALA	4.7
1	D	360	ASN	4.4
1	D	347	GLN	4.0
1	D	359	SER	3.9
1	D	43	LEU	3.8
1	D	41	LYS	3.8
1	D	350	ALA	3.5
1	B	40	ALA	3.5
1	C	346	GLY	3.4
1	C	359	SER	3.4
1	B	359	SER	3.2
1	D	355	SER	3.2
1	A	359	SER	3.2
1	C	344	PRO	3.1
1	D	353	SER	3.1
1	C	345	SER	3.0

Continued on next page...

Continued from previous page...

Mol	Chain	Res	Type	RSRZ
1	D	42	ARG	2.9
1	D	357	PHE	2.9
1	D	349	GLY	2.8
1	D	44	GLN	2.8
1	D	46	ILE	2.8
1	D	346	GLY	2.7
1	B	344	PRO	2.7
1	D	352	ALA	2.5
1	A	44	GLN	2.5
1	B	362	ALA	2.5
1	B	47	GLY	2.4
1	C	41	LYS	2.4
1	B	1	PRO	2.4
1	A	344	PRO	2.3
1	C	362	ALA	2.3
1	D	45	SER	2.3
1	D	39	ILE	2.2
1	D	314	GLY	2.2
1	D	354	GLU	2.2
1	D	36	THR	2.1
1	B	44	GLN	2.1
1	C	49	GLU	2.1
1	B	45	SER	2.1
1	D	351	ALA	2.1
1	B	343	THR	2.0

6.2 Non-standard residues in protein, DNA, RNA chains [i](#)

There are no non-standard protein/DNA/RNA residues in this entry.

6.3 Carbohydrates [i](#)

There are no monosaccharides in this entry.

6.4 Ligands [i](#)

In the following table, the Atoms column lists the number of modelled atoms in the group and the number defined in the chemical component dictionary. The B-factors column lists the minimum, median, 95th percentile and maximum values of B factors of atoms in the group. The column labelled 'Q< 0.9' lists the number of atoms with occupancy less than 0.9.

Mol	Type	Chain	Res	Atoms	RSCC	RSR	B-factors(\AA^2)	Q<0.9
2	13P	B	3002	9/10	0.93	0.12	24,30,36,36	0
2	13P	C	3003	9/10	0.95	0.11	21,26,30,35	0
2	13P	A	3001	9/10	0.96	0.09	21,28,34,36	0
2	13P	D	3004	9/10	0.97	0.08	24,28,38,39	0

6.5 Other polymers [i](#)

There are no such residues in this entry.