



## Full wwPDB EM Validation Report ⓘ

Jan 1, 2023 – 11:22 PM JST

PDB ID : 7CPU  
EMDB ID : EMD-30432  
Title : Cryo-EM structure of 80S ribosome from mouse kidney  
Authors : Huo, Y.G.; He, X.; Jiang, T.; Qin, Y.; Guo, X.J.; Sha, J.H.  
Deposited on : 2020-08-08  
Resolution : 2.82 Å (reported)  
Based on initial model : 6EK0

This is a Full wwPDB EM Validation Report for a publicly released PDB entry.

We welcome your comments at [validation@mail.wwpdb.org](mailto:validation@mail.wwpdb.org)

A user guide is available at

<https://www.wwpdb.org/validation/2017/EMValidationReportHelp>

with specific help available everywhere you see the ⓘ symbol.

The types of validation reports are described at

<http://www.wwpdb.org/validation/2017/FAQs#types>.

---

The following versions of software and data (see [references ⓘ](#)) were used in the production of this report:

EMDB validation analysis : 0.0.1.dev43  
MolProbity : 4.02b-467  
Percentile statistics : 20191225.v01 (using entries in the PDB archive December 25th 2019)  
MapQ : 1.9.9  
Ideal geometry (proteins) : Engh & Huber (2001)  
Ideal geometry (DNA, RNA) : Parkinson et al. (1996)  
Validation Pipeline (wwPDB-VP) : 2.31.3

# 1 Overall quality at a glance

The following experimental techniques were used to determine the structure:  
*ELECTRON MICROSCOPY*

The reported resolution of this entry is 2.82 Å.

Percentile scores (ranging between 0-100) for global validation metrics of the entry are shown in the following graphic. The table shows the number of entries on which the scores are based.

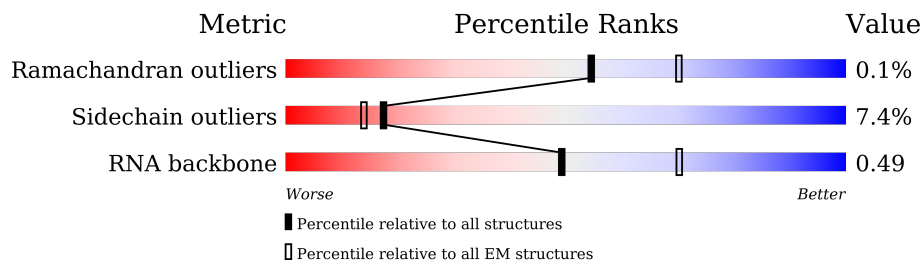

Metric	Whole archive (#Entries)	EM structures (#Entries)
Ramachandran outliers	154571	4023
Sidechain outliers	154315	3826
RNA backbone	4643	859

The table below summarises the geometric issues observed across the polymeric chains and their fit to the map. The red, orange, yellow and green segments of the bar indicate the fraction of residues that contain outliers for  $\geq 3$ , 2, 1 and 0 types of geometric quality criteria respectively. A grey segment represents the fraction of residues that are not modelled. The numeric value for each fraction is indicated below the corresponding segment, with a dot representing fractions  $\leq 5\%$ . The upper red bar (where present) indicates the fraction of residues that have poor fit to the EM map (all-atom inclusion  $< 40\%$ ). The numeric value is given above the bar.

Mol	Chain	Length	Quality of chain
1	LA	257	
2	SA	295	
3	LB	403	
4	SB	264	
5	LC	419	
6	LD	297	
7	LE	296	
8	LF	270	

*Continued on next page...*

Continued from previous page...

Mol	Chain	Length	Quality of chain
9	LG	266	5% 80% 6% 14%
10	LH	192	92% 7%
11	LI	214	90% 6%
12	LJ	178	89% 7%
13	LL	211	90% 8%
14	LM	217	60% 37%
15	LN	204	97%
16	LO	203	94% 5%
17	LP	184	78% 6% 16%
18	LQ	188	97% ..
19	LR	196	84% 5% 11%
20	LS	176	93% 6%
21	LT	160	95% 5%
22	LU	128	73% 5% 22%
23	LV	140	89% 7%
24	LW	157	39% 61%
25	LX	156	72% 24%
26	LY	145	84% 7% 9%
27	LZ	136	95% ..
28	La	148	94% 5%
29	Lb	160	57% 5% 38%
30	Lc	115	78% 18%
31	Ld	125	5% 84% 14%
32	Le	135	93% 5%
33	Lf	110	94% 5%

Continued on next page...

Continued from previous page...

Mol	Chain	Length	Quality of chain
34	Lg	117	90% 6%
35	Lh	123	97%
36	Li	105	90% 7%
37	Lj	97	82% 6% 11%
38	Lk	70	96%
39	Lm	128	40% 60%
40	Ln	25	96%
41	Lo	106	92% 6%
42	Lp	92	97%
43	Lr	137	88% 9%
44	L5	4731	56% 18% 25%
45	L7	120	85% 15%
46	L8	158	6% 78% 21%
47	S2	1870	12% 65% 23% 11%
48	SD	243	41% 85% 7% 9%
49	SE	263	18% 88% 10%
50	SF	204	10% 79% 8% 12%
51	SH	194	37% 84% 9% 7%
52	SI	208	15% 79% 9% 12%
53	SK	165	40% 50% 5% 45%
54	SL	158	6% 77% 9% 15%
55	SP	145	10% 79% 19%
56	SQ	146	15% 87% 8% 5%
57	SR	135	36% 84% 13%
58	SS	152	12% 85% 7% 8%

Continued on next page...

Continued from previous page...

Mol	Chain	Length	Quality of chain
59	ST	145	9% 91% 6%
60	SU	119	45% 69% 11% 20%
61	SV	83	11% 90% 6%
62	SX	143	6% 90% 7%
63	Sa	115	77% 9% 14%
64	Sc	69	16% 71% 7% 22%
65	Sd	56	9% 91% 5%
66	Sg	317	50% 75% 12% 13%
67	SC	293	69% 27%
68	SG	249	37% 73% 8% 18%
69	SJ	194	20% 63% 8% 29%
70	SN	151	6% 93% 7%
71	SO	151	83% 6% 11%
72	SW	130	92% 7%
73	SY	133	36% 73% 10% 17%
74	SZ	125	16% 53% 5% 42%
75	Sb	84	19% 89% 10%
76	Se	133	9% 34% 64%
77	S6	75	25% 55% 44%
78	Ll	51	92% 6%

## 2 Entry composition [i](#)

There are 81 unique types of molecules in this entry. The entry contains 206288 atoms, of which 0 are hydrogens and 0 are deuteriums.

In the tables below, the AltConf column contains the number of residues with at least one atom in alternate conformation and the Trace column contains the number of residues modelled with at most 2 atoms.

- Molecule 1 is a protein called 60S ribosomal protein L8.

Mol	Chain	Residues	Atoms					AltConf	Trace
			Total	C	N	O	S		
1	LA	248	1898	1189	389	314	6	0	0

- Molecule 2 is a protein called 40S ribosomal protein SA.

Mol	Chain	Residues	Atoms					AltConf	Trace
			Total	C	N	O	S		
2	SA	207	1636	1042	288	298	8	0	0

- Molecule 3 is a protein called 60S ribosomal protein L3.

Mol	Chain	Residues	Atoms					AltConf	Trace
			Total	C	N	O	S		
3	LB	397	3202	2039	603	546	14	0	0

- Molecule 4 is a protein called 40S ribosomal protein S3a.

Mol	Chain	Residues	Atoms					AltConf	Trace
			Total	C	N	O	S		
4	SB	213	1729	1098	309	308	14	0	0

- Molecule 5 is a protein called 60S ribosomal protein L4.

Mol	Chain	Residues	Atoms					AltConf	Trace
			Total	C	N	O	S		
5	LC	362	2891	1819	577	480	15	0	0

- Molecule 6 is a protein called 60S ribosomal protein L5.

Mol	Chain	Residues	Atoms					AltConf	Trace
			Total	C	N	O	S		
6	LD	293	2385	1506	440	425	14	0	0

- Molecule 7 is a protein called 60S ribosomal protein L6.

Mol	Chain	Residues	Atoms					AltConf	Trace
			Total	C	N	O	S		
7	LE	231	1874	1195	358	317	4	0	0

- Molecule 8 is a protein called 60S ribosomal protein L7.

Mol	Chain	Residues	Atoms					AltConf	Trace
			Total	C	N	O	S		
8	LF	214	1771	1139	337	287	8	0	0

- Molecule 9 is a protein called 60S ribosomal protein L7a.

Mol	Chain	Residues	Atoms					AltConf	Trace
			Total	C	N	O	S		
9	LG	229	1848	1179	354	311	4	0	0

- Molecule 10 is a protein called 60S ribosomal protein L9.

Mol	Chain	Residues	Atoms					AltConf	Trace
			Total	C	N	O	S		
10	LH	190	1519	956	284	273	6	0	0

- Molecule 11 is a protein called 60S ribosomal protein L10.

Mol	Chain	Residues	Atoms					AltConf	Trace
			Total	C	N	O	S		
11	LI	201	1633	1037	316	268	12	0	0

- Molecule 12 is a protein called 60S ribosomal protein L11.

Mol	Chain	Residues	Atoms					AltConf	Trace
			Total	C	N	O	S		
12	LJ	171	1371	866	255	244	6	0	0

- Molecule 13 is a protein called 60S ribosomal protein L13.

Mol	Chain	Residues	Atoms					AltConf	Trace
			Total	C	N	O	S		
13	LL	206	1667	1043	343	277	4	0	0

- Molecule 14 is a protein called 60S ribosomal protein L14.

Mol	Chain	Residues	Atoms					AltConf	Trace
14	LM	136	Total	C	N	O	S	0	0
			1125	721	218	179	7		

- Molecule 15 is a protein called 60S ribosomal protein L15.

Mol	Chain	Residues	Atoms					AltConf	Trace
15	LN	203	Total	C	N	O	S	0	0
			1701	1072	359	266	4		

- Molecule 16 is a protein called 60S ribosomal protein L13a.

Mol	Chain	Residues	Atoms					AltConf	Trace
16	LO	201	Total	C	N	O	S	0	0
			1640	1055	320	259	6		

- Molecule 17 is a protein called 60S ribosomal protein L17.

Mol	Chain	Residues	Atoms					AltConf	Trace
17	LP	154	Total	C	N	O	S	0	0
			1251	782	243	217	9		

- Molecule 18 is a protein called 60S ribosomal protein L18.

Mol	Chain	Residues	Atoms					AltConf	Trace
18	LQ	187	Total	C	N	O	S	0	0
			1515	948	314	249	4		

- Molecule 19 is a protein called 60S ribosomal protein L19.

Mol	Chain	Residues	Atoms					AltConf	Trace
19	LR	174	Total	C	N	O	S	0	0
			1457	901	316	231	9		

- Molecule 20 is a protein called 60S ribosomal protein L18a.

Mol	Chain	Residues	Atoms					AltConf	Trace
20	LS	175	Total	C	N	O	S	0	0
			1451	924	283	234	10		

- Molecule 21 is a protein called 60S ribosomal protein L21.



Mol	Chain	Residues	Atoms					AltConf	Trace
			Total	C	N	O	S		
21	LT	160	1307	829	253	218	7	0	0

- Molecule 22 is a protein called 60S ribosomal protein L22.

Mol	Chain	Residues	Atoms					AltConf	Trace
			Total	C	N	O	S		
22	LU	100	817	523	143	149	2	0	0

- Molecule 23 is a protein called 60S ribosomal protein L23.

Mol	Chain	Residues	Atoms					AltConf	Trace
			Total	C	N	O	S		
23	LV	130	973	615	183	170	5	0	0

- Molecule 24 is a protein called 60S ribosomal protein L24.

Mol	Chain	Residues	Atoms					AltConf	Trace
			Total	C	N	O	S		
24	LW	62	519	332	101	83	3	0	0

- Molecule 25 is a protein called 60S ribosomal protein L23a.

Mol	Chain	Residues	Atoms					AltConf	Trace
			Total	C	N	O	S		
25	LX	118	967	618	181	167	1	0	0

- Molecule 26 is a protein called 60S ribosomal protein L26.

Mol	Chain	Residues	Atoms					AltConf	Trace
			Total	C	N	O	S		
26	LY	132	1102	692	223	184	3	0	0

- Molecule 27 is a protein called 60S ribosomal protein L27.

Mol	Chain	Residues	Atoms					AltConf	Trace
			Total	C	N	O	S		
27	LZ	135	1107	714	208	182	3	0	0

- Molecule 28 is a protein called 60S ribosomal protein L27a.

Mol	Chain	Residues	Atoms					AltConf	Trace
			Total	C	N	O	S		
28	La	147	1164	736	239	185	4	0	0

- Molecule 29 is a protein called 60S ribosomal protein L29.

Mol	Chain	Residues	Atoms					AltConf	Trace
			Total	C	N	O	S		
29	Lb	99	807	505	174	124	4	0	0

- Molecule 30 is a protein called 60S ribosomal protein L30.

Mol	Chain	Residues	Atoms					AltConf	Trace
			Total	C	N	O	S		
30	Lc	94	732	465	130	131	6	0	0

- Molecule 31 is a protein called 60S ribosomal protein L31.

Mol	Chain	Residues	Atoms					AltConf	Trace
			Total	C	N	O	S		
31	Ld	108	896	566	172	156	2	0	0

- Molecule 32 is a protein called 60S ribosomal protein L32.

Mol	Chain	Residues	Atoms					AltConf	Trace
			Total	C	N	O	S		
32	Le	128	1053	667	216	165	5	0	0

- Molecule 33 is a protein called 60S ribosomal protein L35a.

Mol	Chain	Residues	Atoms					AltConf	Trace
			Total	C	N	O	S		
33	Lf	109	876	555	174	143	4	0	0

- Molecule 34 is a protein called 60S ribosomal protein L34.

Mol	Chain	Residues	Atoms					AltConf	Trace
			Total	C	N	O	S		
34	Lg	110	873	546	180	141	6	0	0

- Molecule 35 is a protein called 60S ribosomal protein L35.

Mol	Chain	Residues	Atoms					AltConf	Trace
35	Lh	122	Total	C	N	O	S	0	0
			1015	643	204	167	1		

- Molecule 36 is a protein called 60S ribosomal protein L36.

Mol	Chain	Residues	Atoms					AltConf	Trace
36	Li	102	Total	C	N	O	S	0	0
			832	521	177	129	5		

- Molecule 37 is a protein called 60S ribosomal protein L37.

Mol	Chain	Residues	Atoms					AltConf	Trace
37	Lj	86	Total	C	N	O	S	0	0
			705	434	155	111	5		

- Molecule 38 is a protein called 60S ribosomal protein L38.

Mol	Chain	Residues	Atoms					AltConf	Trace
38	Lk	69	Total	C	N	O	S	0	0
			568	365	103	99	1		

- Molecule 39 is a protein called Ubiquitin-60S ribosomal protein L40.

Mol	Chain	Residues	Atoms					AltConf	Trace
39	Lm	51	Total	C	N	O	S	0	0
			419	260	88	65	6		

- Molecule 40 is a protein called 60S ribosomal protein L41.

Mol	Chain	Residues	Atoms					AltConf	Trace
40	Ln	25	Total	C	N	O	S	0	0
			239	145	64	27	3		

- Molecule 41 is a protein called 60S ribosomal protein L36a.

Mol	Chain	Residues	Atoms					AltConf	Trace
41	Lo	103	Total	C	N	O	S	0	0
			842	528	172	136	6		

- Molecule 42 is a protein called 60S ribosomal protein L37a.

Mol	Chain	Residues	Atoms					AltConf	Trace
			Total	C	N	O	S		
42	Lp	91	708	445	136	120	7	0	0

- Molecule 43 is a protein called 60S ribosomal protein L28.

Mol	Chain	Residues	Atoms					AltConf	Trace
			Total	C	N	O	S		
43	Lr	124	994	616	206	167	5	0	0

- Molecule 44 is a RNA chain called Mus musculus 28S ribosomal RNA.

Mol	Chain	Residues	Atoms					AltConf	Trace
			Total	C	N	O	P		
44	L5	3539	75867	33789	13863	24677	3538	0	0

- Molecule 45 is a RNA chain called Mus musculus 5S ribosomal RNA.

Mol	Chain	Residues	Atoms					AltConf	Trace
			Total	C	N	O	P		
45	L7	120	2558	1141	456	842	119	0	0

- Molecule 46 is a RNA chain called Mus musculus 5.8S ribosomal RNA.

Mol	Chain	Residues	Atoms					AltConf	Trace
			Total	C	N	O	P		
46	L8	156	3314	1480	585	1094	155	0	0

- Molecule 47 is a RNA chain called Mus musculus 18S ribosomal RNA.

Mol	Chain	Residues	Atoms					AltConf	Trace
			Total	C	N	O	P		
47	S2	1656	35228	15723	6313	11537	1655	0	0

- Molecule 48 is a protein called 40S ribosomal protein S3.

Mol	Chain	Residues	Atoms					AltConf	Trace
			Total	C	N	O	S		
48	SD	222	1726	1100	310	309	7	0	0

- Molecule 49 is a protein called 40S ribosomal protein S4, X isoform.

Mol	Chain	Residues	Atoms					AltConf	Trace
			Total	C	N	O	S		
49	SE	258	2050	1311	381	350	8	0	0

- Molecule 50 is a protein called 40S ribosomal protein S5.

Mol	Chain	Residues	Atoms					AltConf	Trace
			Total	C	N	O	S		
50	SF	179	1416	888	262	259	7	0	0

- Molecule 51 is a protein called 40S ribosomal protein S7.

Mol	Chain	Residues	Atoms					AltConf	Trace
			Total	C	N	O	S		
51	SH	180	1449	924	266	258	1	0	0

- Molecule 52 is a protein called 40S ribosomal protein S8.

Mol	Chain	Residues	Atoms					AltConf	Trace
			Total	C	N	O	S		
52	SI	183	1499	943	293	258	5	0	0

- Molecule 53 is a protein called 40S ribosomal protein S10.

Mol	Chain	Residues	Atoms					AltConf	Trace
			Total	C	N	O	S		
53	SK	90	760	495	135	124	6	0	0

- Molecule 54 is a protein called 40S ribosomal protein S11.

Mol	Chain	Residues	Atoms					AltConf	Trace
			Total	C	N	O	S		
54	SL	135	1110	708	207	189	6	0	0

- Molecule 55 is a protein called 40S ribosomal protein S15.

Mol	Chain	Residues	Atoms					AltConf	Trace
			Total	C	N	O	S		
55	SP	118	981	625	183	166	7	0	0

- Molecule 56 is a protein called 40S ribosomal protein S16.

Mol	Chain	Residues	Atoms					AltConf	Trace
			Total	C	N	O	S		
56	SQ	139	1109	704	210	192	3	0	0

- Molecule 57 is a protein called 40S ribosomal protein S17.

Mol	Chain	Residues	Atoms					AltConf	Trace
			Total	C	N	O	S		
57	SR	131	1064	668	198	194	4	0	0

- Molecule 58 is a protein called 40S ribosomal protein S18.

Mol	Chain	Residues	Atoms					AltConf	Trace
			Total	C	N	O	S		
58	SS	140	1157	728	231	197	1	0	0

- Molecule 59 is a protein called 40S ribosomal protein S19.

Mol	Chain	Residues	Atoms					AltConf	Trace
			Total	C	N	O	S		
59	ST	140	1090	681	212	195	2	0	0

- Molecule 60 is a protein called 40S ribosomal protein S20.

Mol	Chain	Residues	Atoms					AltConf	Trace
			Total	C	N	O	S		
60	SU	95	753	471	142	136	4	0	0

- Molecule 61 is a protein called 40S ribosomal protein S21.

Mol	Chain	Residues	Atoms					AltConf	Trace
			Total	C	N	O	S		
61	SV	80	610	373	114	118	5	0	0

- Molecule 62 is a protein called 40S ribosomal protein S23.

Mol	Chain	Residues	Atoms					AltConf	Trace
			Total	C	N	O	S		
62	SX	139	1080	682	214	181	3	0	0

- Molecule 63 is a protein called 40S ribosomal protein S26.

Mol	Chain	Residues	Atoms					AltConf	Trace
63	Sa	99	Total	C	N	O	S	1	0
			800	497	168	130	5		

- Molecule 64 is a protein called 40S ribosomal protein S28.

Mol	Chain	Residues	Atoms					AltConf	Trace
64	Sc	54	Total	C	N	O	S	0	0
			416	257	80	77	2		

- Molecule 65 is a protein called 40S ribosomal protein S29.

Mol	Chain	Residues	Atoms					AltConf	Trace
65	Sd	54	Total	C	N	O	S	0	0
			455	284	93	73	5		

- Molecule 66 is a protein called Receptor of activated protein C kinase 1.

Mol	Chain	Residues	Atoms					AltConf	Trace
66	Sg	276	Total	C	N	O	S	0	0
			2148	1357	378	401	12		

- Molecule 67 is a protein called 40S ribosomal protein S2.

Mol	Chain	Residues	Atoms					AltConf	Trace
67	SC	215	Total	C	N	O	S	1	0
			1673	1085	288	291	9		

- Molecule 68 is a protein called 40S ribosomal protein S6.

Mol	Chain	Residues	Atoms					AltConf	Trace
68	SG	204	Total	C	N	O	S	0	0
			1645	1029	330	280	6		

- Molecule 69 is a protein called 40S ribosomal protein S9.

Mol	Chain	Residues	Atoms					AltConf	Trace
69	SJ	138	Total	C	N	O	S	0	0
			1162	743	230	187	2		

- Molecule 70 is a protein called 40S ribosomal protein S13.

Mol	Chain	Residues	Atoms					AltConf	Trace
			Total	C	N	O	S		
70	SN	150	1208	773	229	205	1	0	0

- Molecule 71 is a protein called 40S ribosomal protein S14.

Mol	Chain	Residues	Atoms					AltConf	Trace
			Total	C	N	O	S		
71	SO	134	1002	612	197	187	6	0	0

- Molecule 72 is a protein called 40S ribosomal protein S15a.

Mol	Chain	Residues	Atoms					AltConf	Trace
			Total	C	N	O	S		
72	SW	129	1034	659	193	176	6	0	0

- Molecule 73 is a protein called 40S ribosomal protein S24.

Mol	Chain	Residues	Atoms					AltConf	Trace
			Total	C	N	O	S		
73	SY	110	891	565	173	149	4	0	0

- Molecule 74 is a protein called 40S ribosomal protein S25.

Mol	Chain	Residues	Atoms					AltConf	Trace
			Total	C	N	O	S		
74	SZ	72	574	368	104	101	1	0	0

- Molecule 75 is a protein called 40S ribosomal protein S27.

Mol	Chain	Residues	Atoms					AltConf	Trace
			Total	C	N	O	S		
75	Sb	83	651	408	121	115	7	0	0

- Molecule 76 is a protein called 40S ribosomal protein S30.

Mol	Chain	Residues	Atoms					AltConf	Trace
			Total	C	N	O	S		
76	Se	48	384	234	86	63	1	0	0

- Molecule 77 is a RNA chain called tRNA.



Mol	Chain	Residues	Atoms					AltConf	Trace
			Total	C	N	O	P		
77	S6	75	1604	717	298	515	74	0	0

- Molecule 78 is a protein called Ribosomal protein L39.

Mol	Chain	Residues	Atoms					AltConf	Trace
			Total	C	N	O	S		
78	L1	50	444	281	98	64	1	0	0

- Molecule 79 is MAGNESIUM ION (three-letter code: MG) (formula: Mg).

Mol	Chain	Residues	Atoms		AltConf
79	LN	1	Total	Mg	0
			1	1	
79	LP	1	Total	Mg	0
			1	1	
79	LT	1	Total	Mg	0
			1	1	
79	LV	1	Total	Mg	0
			1	1	
79	Le	1	Total	Mg	0
			1	1	
79	Lf	1	Total	Mg	0
			1	1	
79	L5	173	Total	Mg	0
			173	173	
79	L7	3	Total	Mg	0
			3	3	
79	L8	5	Total	Mg	0
			5	5	
79	S2	82	Total	Mg	0
			82	82	
79	SF	1	Total	Mg	0
			1	1	
79	Sd	1	Total	Mg	0
			1	1	

- Molecule 80 is ZINC ION (three-letter code: ZN) (formula: Zn).

Mol	Chain	Residues	Atoms		AltConf
80	Lg	1	Total	Zn	0
			1	1	

*Continued on next page...*

*Continued from previous page...*

Mol	Chain	Residues	Atoms		AltConf
80	Lj	1	Total 1	Zn 1	0
80	Lm	1	Total 1	Zn 1	0
80	Lo	1	Total 1	Zn 1	0
80	Lp	1	Total 1	Zn 1	0
80	Sa	1	Total 1	Zn 1	0
80	Sd	1	Total 1	Zn 1	0

- Molecule 81 is water.

Mol	Chain	Residues	Atoms		AltConf
81	LB	1	Total 1	O 1	0
81	LH	1	Total 1	O 1	0
81	LI	2	Total 2	O 2	0
81	La	2	Total 2	O 2	0
81	L5	9	Total 9	O 9	0
81	S2	3	Total 3	O 3	0
81	SV	1	Total 1	O 1	0

### 3 Residue-property plots

These plots are drawn for all protein, RNA, DNA and oligosaccharide chains in the entry. The first graphic for a chain summarises the proportions of the various outlier classes displayed in the second graphic. The second graphic shows the sequence view annotated by issues in geometry and atom inclusion in map density. Residues are color-coded according to the number of geometric quality criteria for which they contain at least one outlier: green = 0, yellow = 1, orange = 2 and red = 3 or more. A red diamond above a residue indicates a poor fit to the EM map for this residue (all-atom inclusion < 40%). Stretches of 2 or more consecutive residues without any outlier are shown as a green connector. Residues present in the sample, but not in the model, are shown in grey.

- Molecule 1: 60S ribosomal protein L8

Chain LA:  93%



- Molecule 2: 40S ribosomal protein SA

Chain SA:  7% 65% 5% 30%

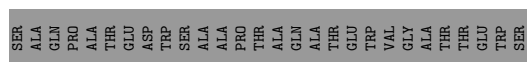
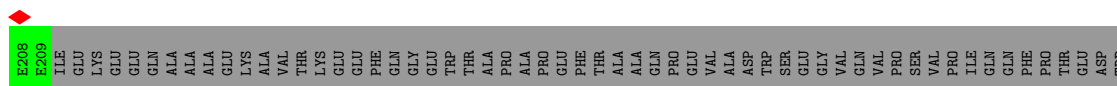

- Molecule 3: 60S ribosomal protein L3

Chain LB:  95%



- Molecule 4: 40S ribosomal protein S3a

Chain SB:  5% 77% 19%

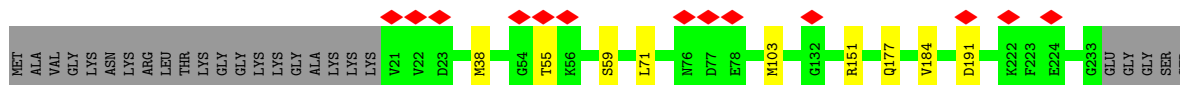



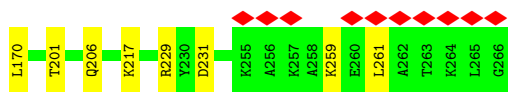

• Molecule 10: 60S ribosomal protein L9



• Molecule 11: 60S ribosomal protein L10

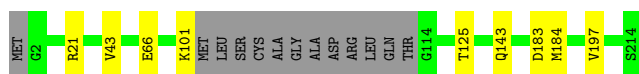
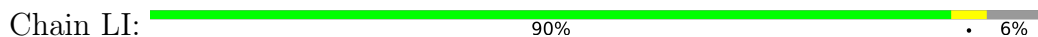

• Molecule 12: 60S ribosomal protein L11

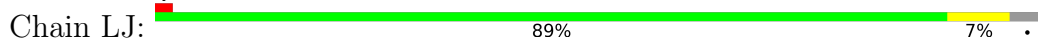

• Molecule 13: 60S ribosomal protein L13



• Molecule 14: 60S ribosomal protein L14

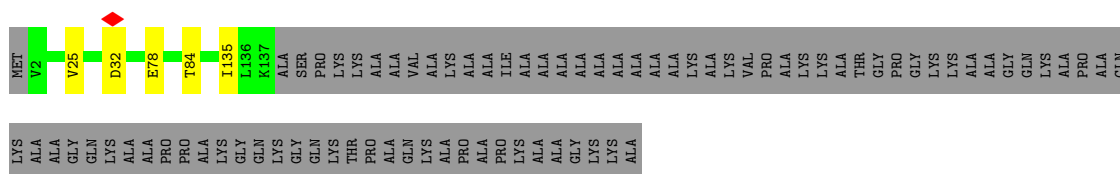

• Molecule 15: 60S ribosomal protein L15



- Molecule 16: 60S ribosomal protein L13a

Chain LO:  94% 5%



- Molecule 17: 60S ribosomal protein L17

Chain LP:  78% 6% 16%

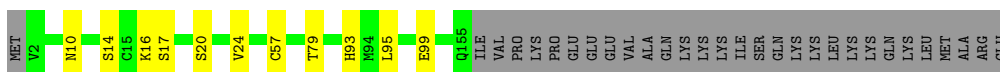

- Molecule 18: 60S ribosomal protein L18

Chain LQ:  97%



- Molecule 19: 60S ribosomal protein L19

Chain LR:  84% 5% 11%

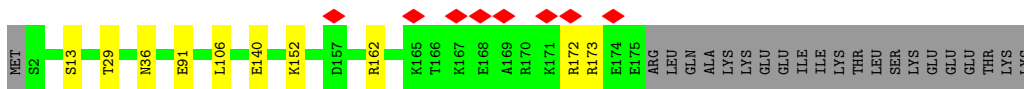

- Molecule 20: 60S ribosomal protein L18a

Chain LS:  93% 6%



- Molecule 21: 60S ribosomal protein L21

Chain LT:  95% 5%



- Molecule 22: 60S ribosomal protein L22

Chain LU:  73% 5% 22%

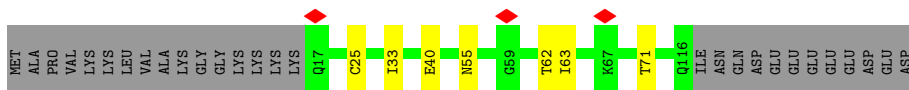

• Molecule 23: 60S ribosomal protein L23

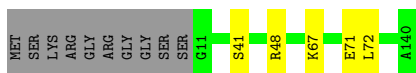
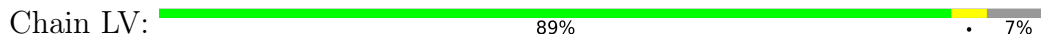

• Molecule 24: 60S ribosomal protein L24

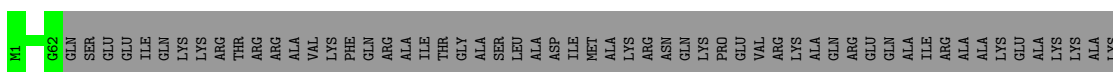

• Molecule 25: 60S ribosomal protein L23a

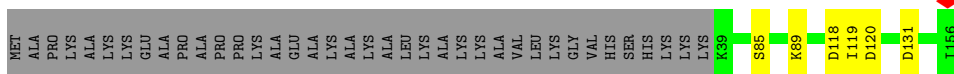
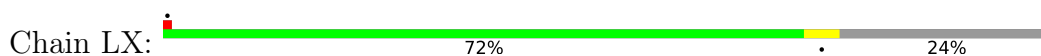

• Molecule 26: 60S ribosomal protein L26

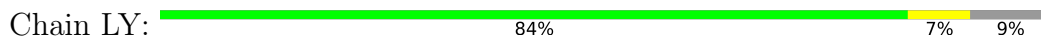

• Molecule 27: 60S ribosomal protein L27

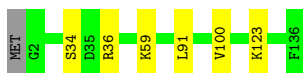

• Molecule 28: 60S ribosomal protein L27a

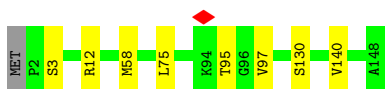

• Molecule 29: 60S ribosomal protein L29

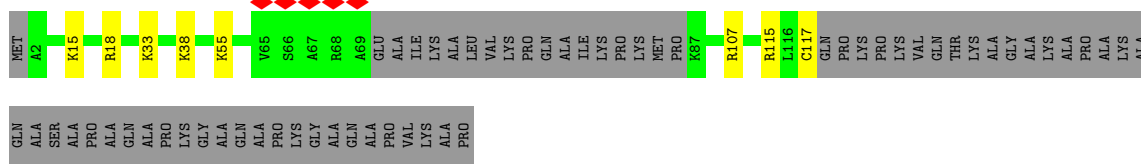

• Molecule 30: 60S ribosomal protein L30

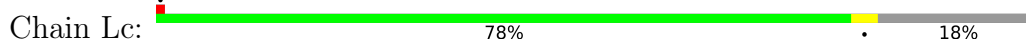

• Molecule 31: 60S ribosomal protein L31

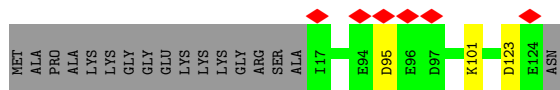
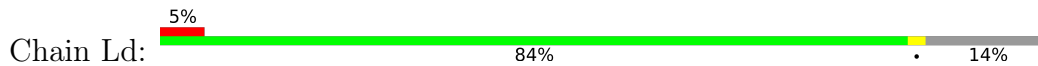

• Molecule 32: 60S ribosomal protein L32



• Molecule 33: 60S ribosomal protein L35a

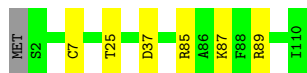

• Molecule 34: 60S ribosomal protein L34

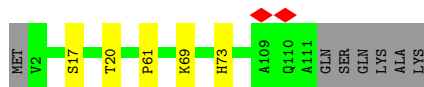
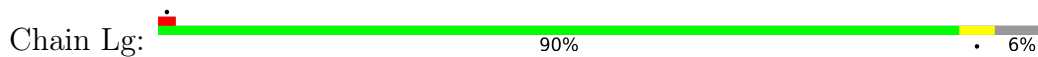

• Molecule 35: 60S ribosomal protein L35





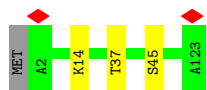

• Molecule 36: 60S ribosomal protein L36

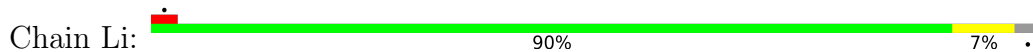

• Molecule 37: 60S ribosomal protein L37

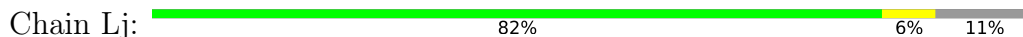

• Molecule 38: 60S ribosomal protein L38

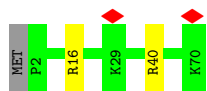

• Molecule 39: Ubiquitin-60S ribosomal protein L40

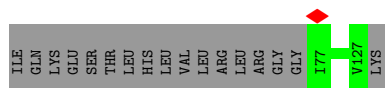
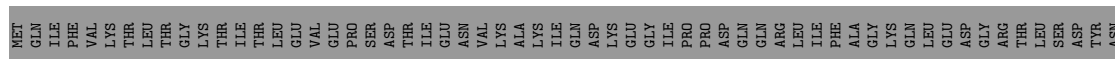

• Molecule 40: 60S ribosomal protein L41

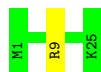

• Molecule 41: 60S ribosomal protein L36a





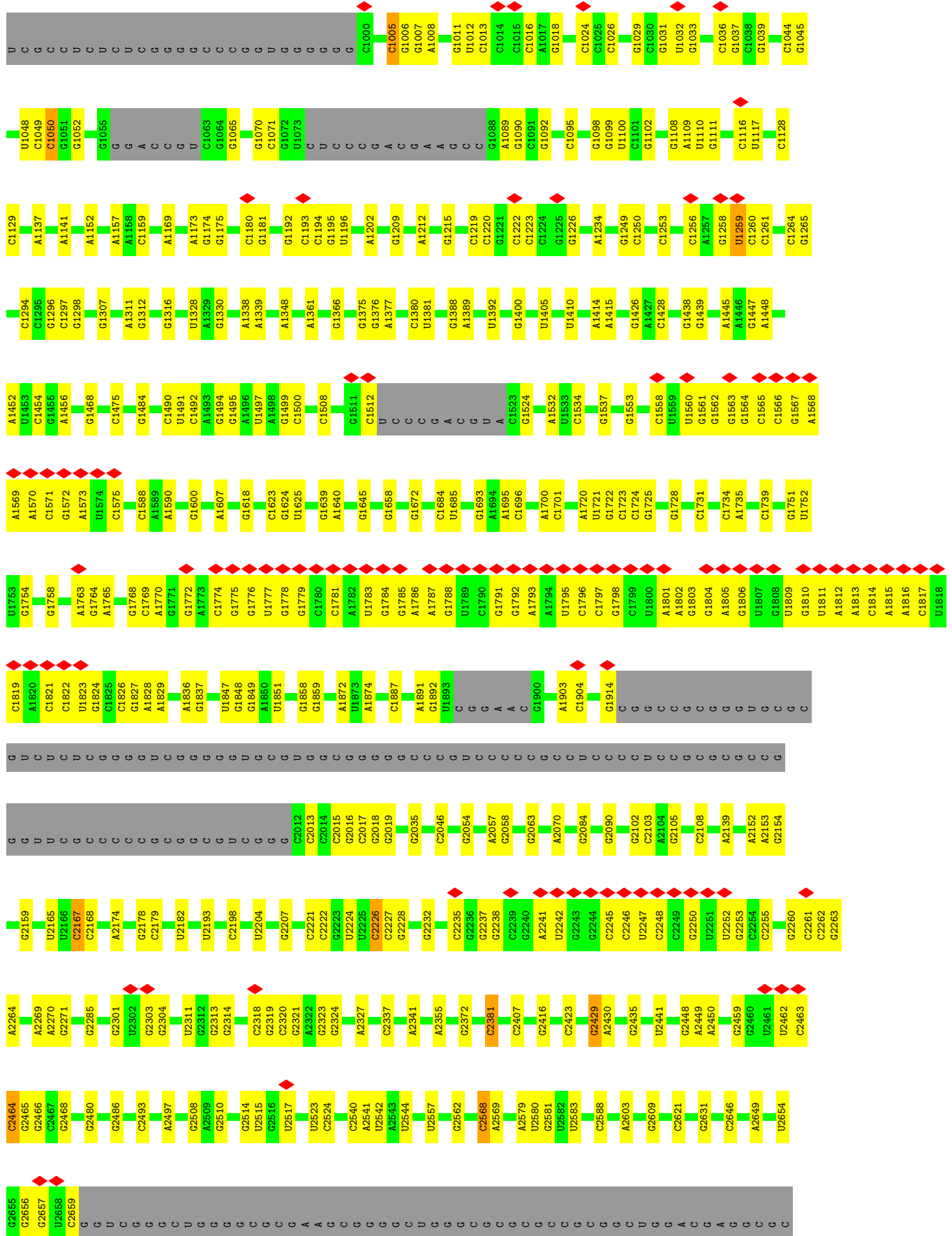



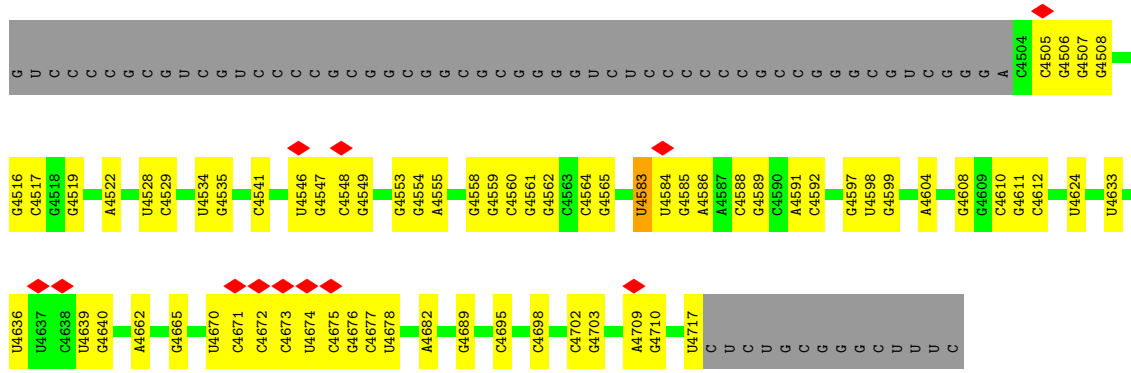

● Molecule 45: Mus musculus 5S ribosomal RNA

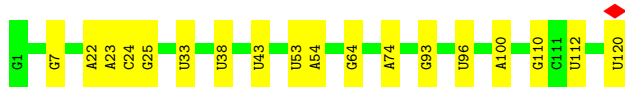
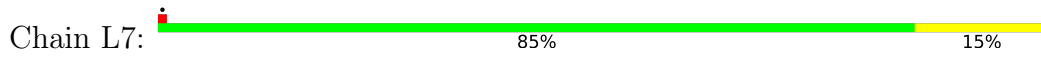

● Molecule 46: Mus musculus 5.8S ribosomal RNA

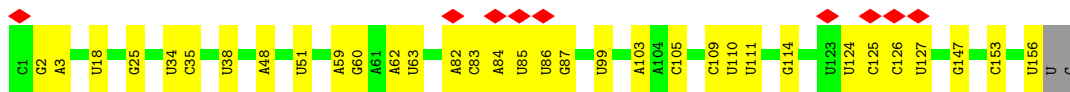
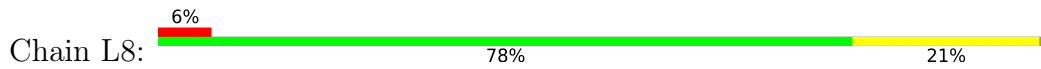

● Molecule 47: Mus musculus 18S ribosomal RNA

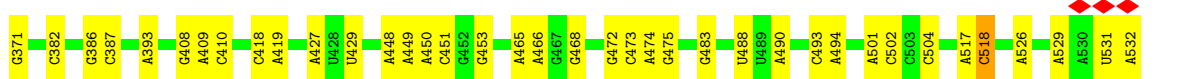
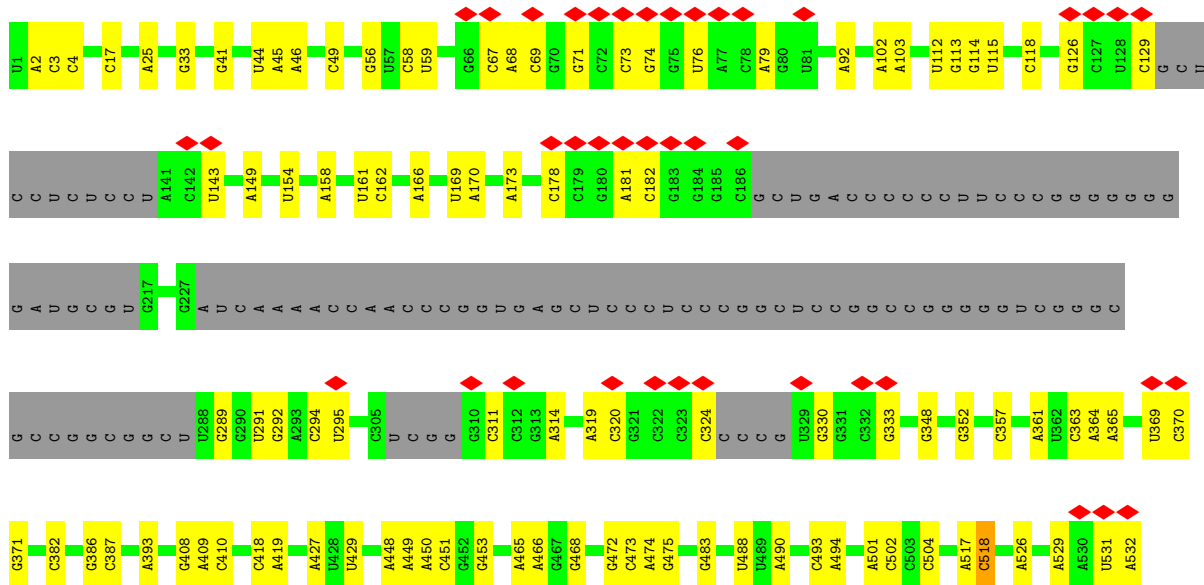

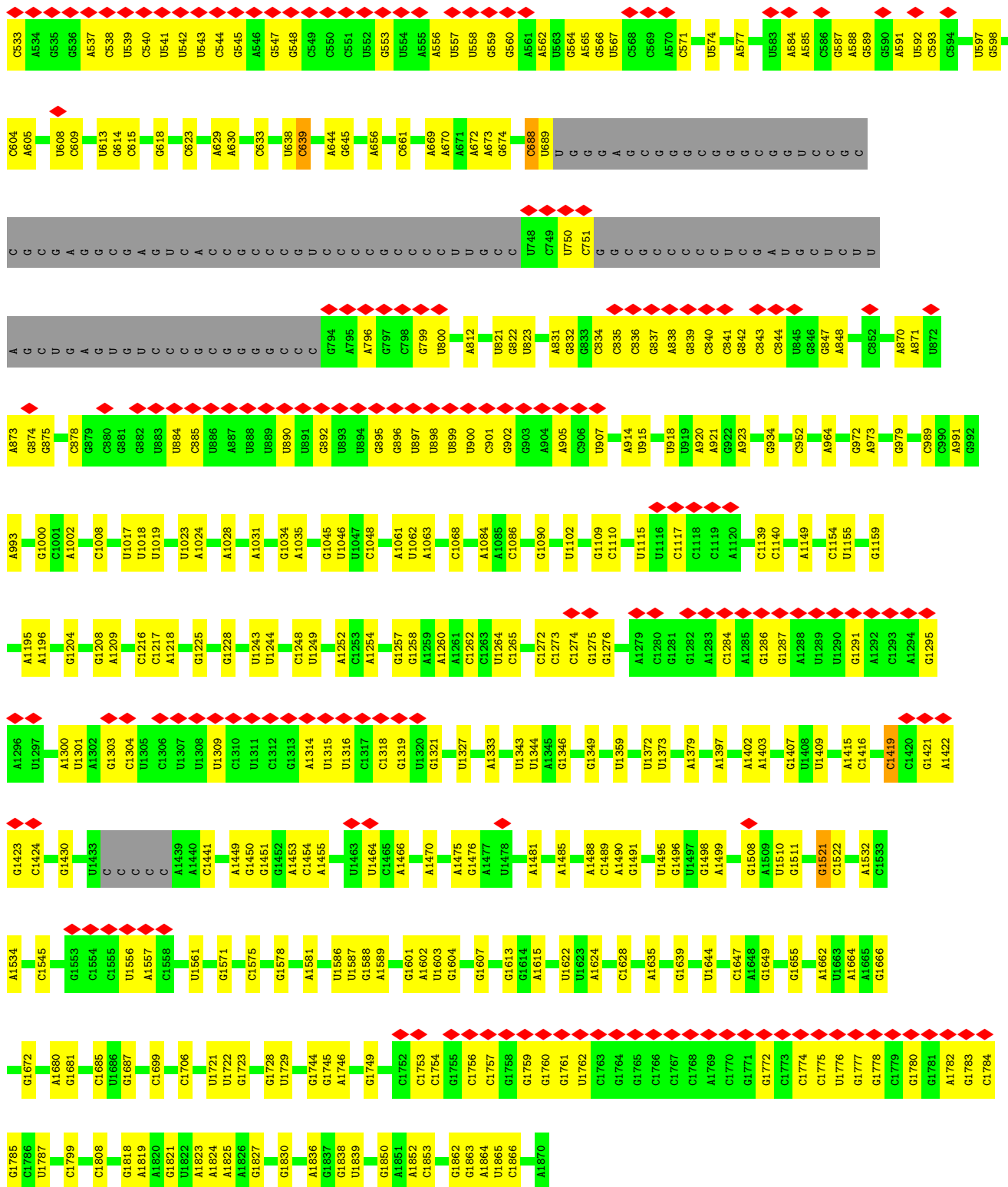

● Molecule 48: 40S ribosomal protein S3

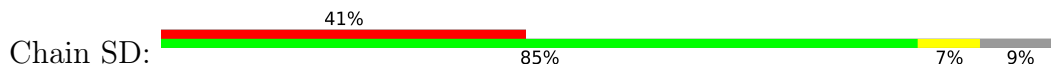

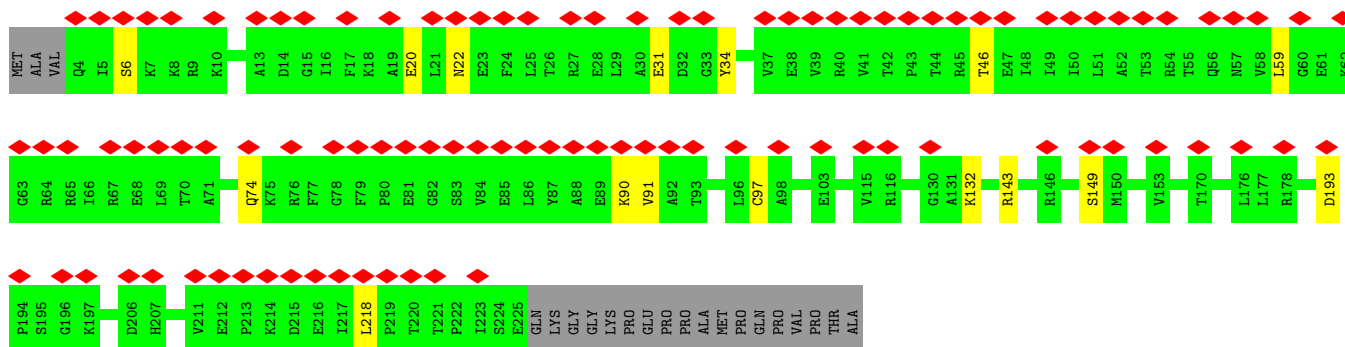

• Molecule 49: 40S ribosomal protein S4, X isoform

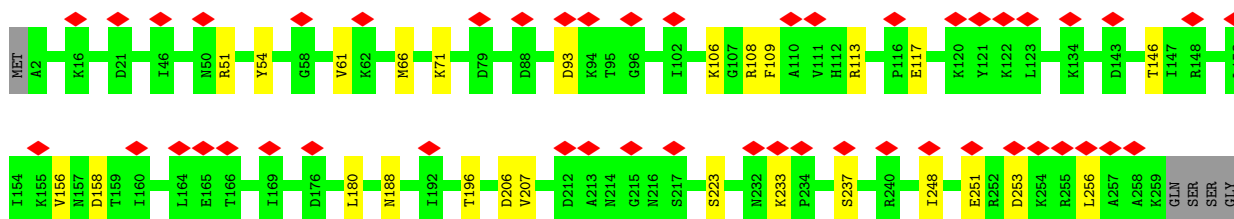
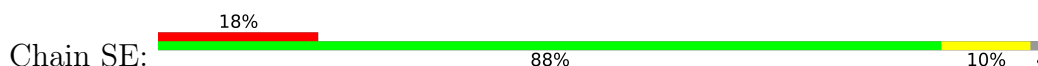

• Molecule 50: 40S ribosomal protein S5

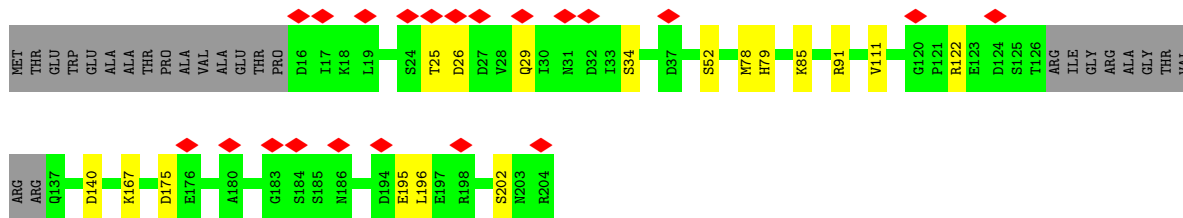
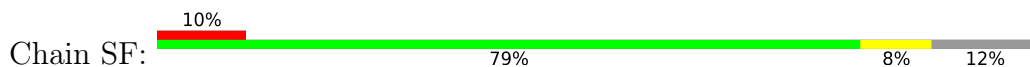

• Molecule 51: 40S ribosomal protein S7

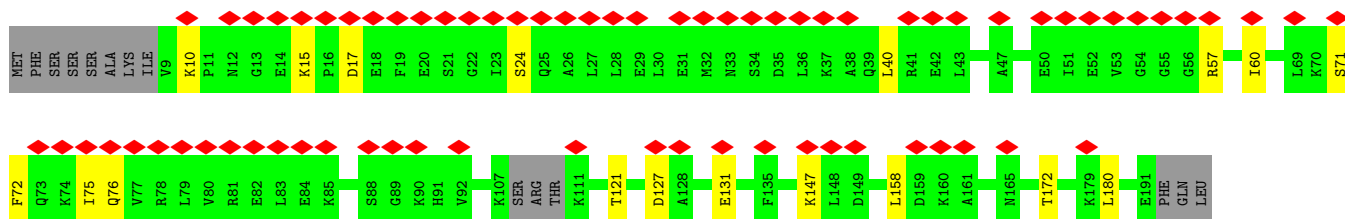
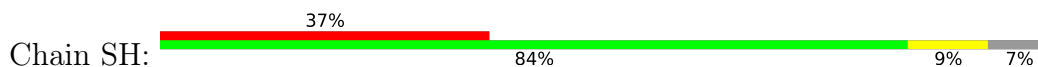

• Molecule 52: 40S ribosomal protein S8

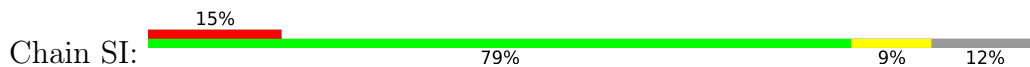

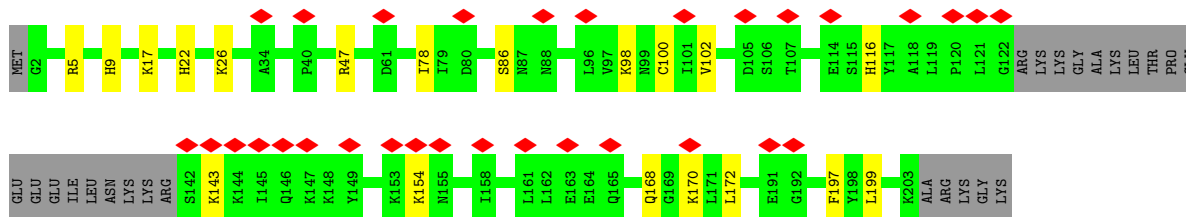

• Molecule 53: 40S ribosomal protein S10

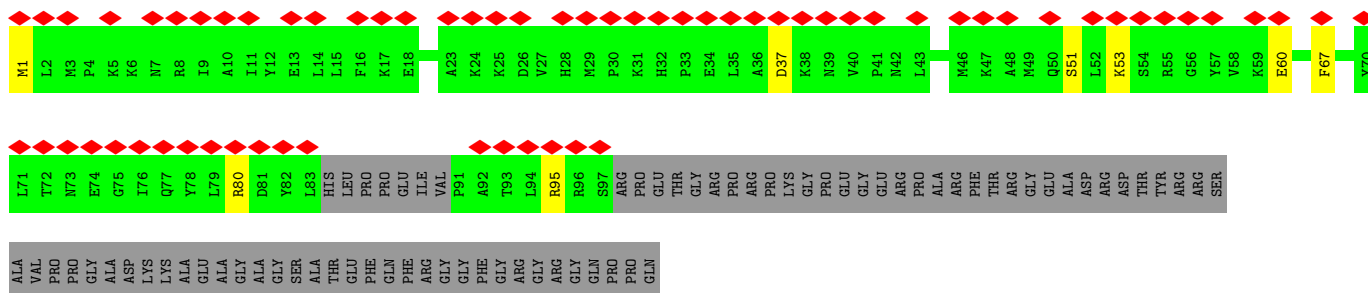
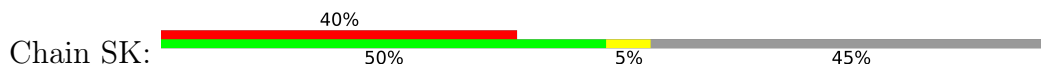

• Molecule 54: 40S ribosomal protein S11

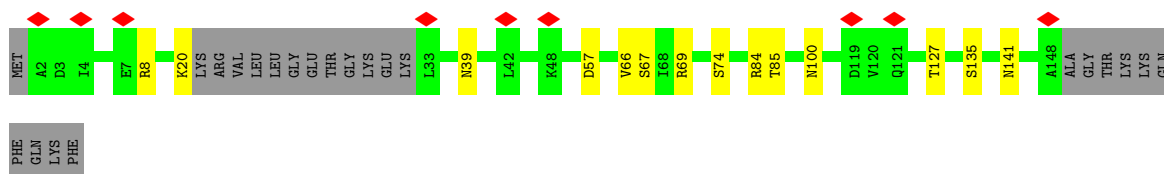
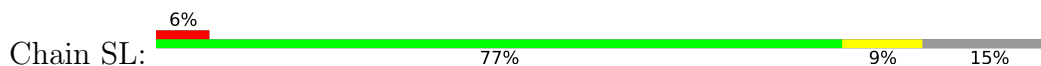

• Molecule 55: 40S ribosomal protein S15

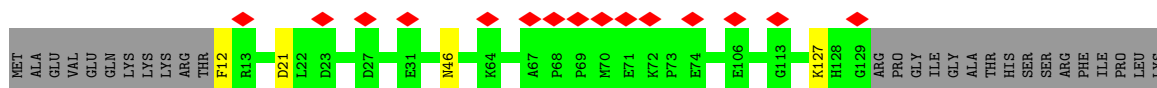
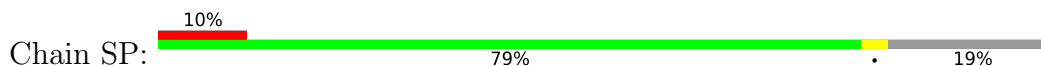

• Molecule 56: 40S ribosomal protein S16

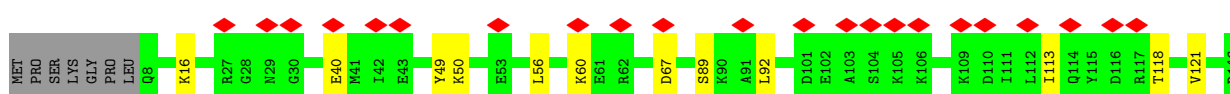
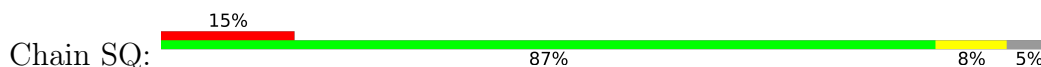

• Molecule 57: 40S ribosomal protein S17

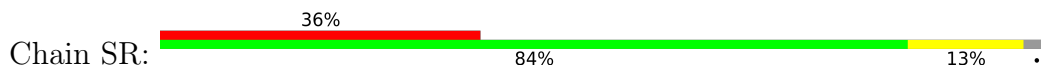



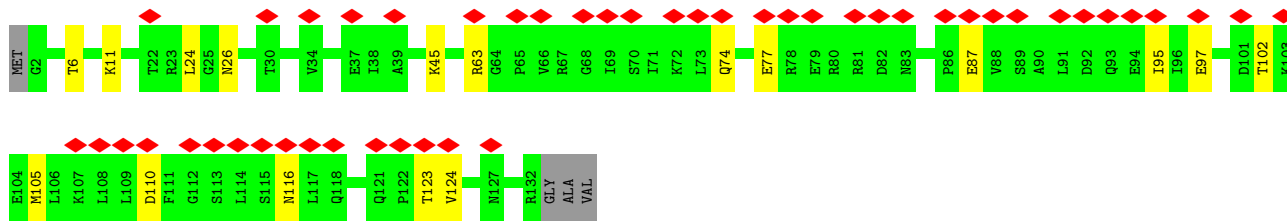

• Molecule 58: 40S ribosomal protein S18

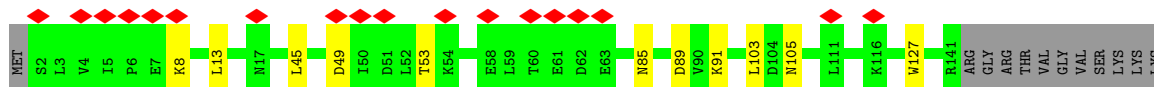
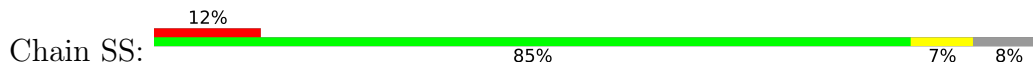

• Molecule 59: 40S ribosomal protein S19

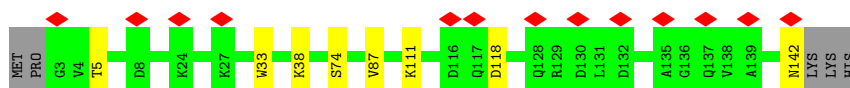

• Molecule 60: 40S ribosomal protein S20

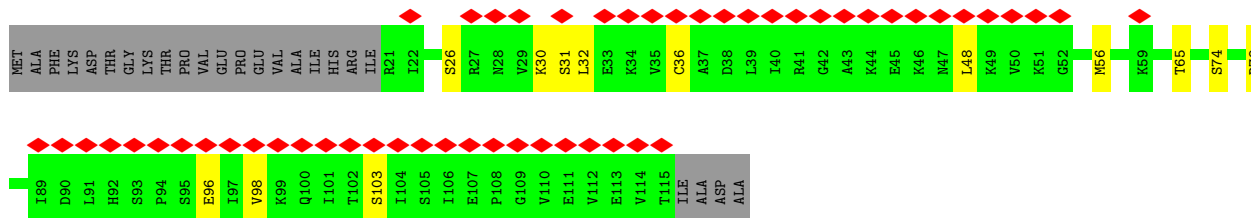
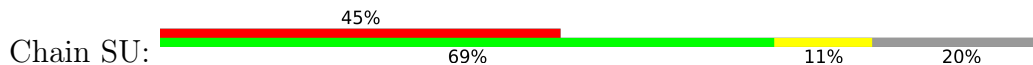

• Molecule 61: 40S ribosomal protein S21

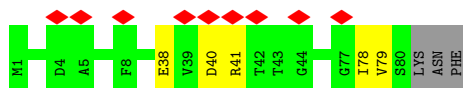
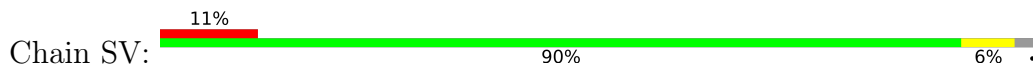

• Molecule 62: 40S ribosomal protein S23

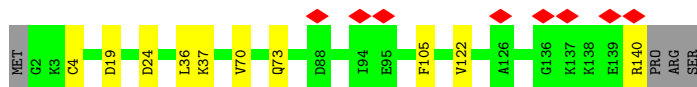
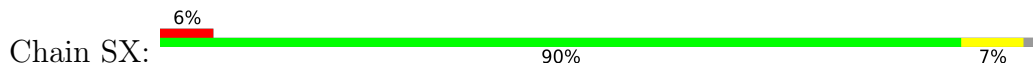

• Molecule 63: 40S ribosomal protein S26

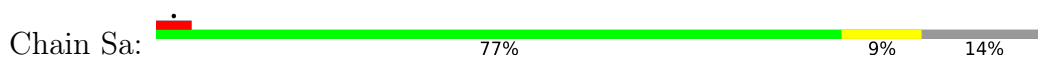

- Molecule 64: 40S ribosomal protein S28

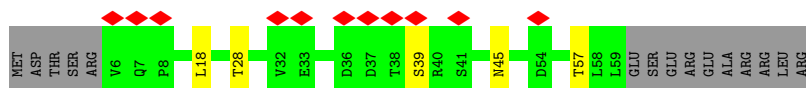

- Molecule 65: 40S ribosomal protein S29



- Molecule 66: Receptor of activated protein C kinase 1

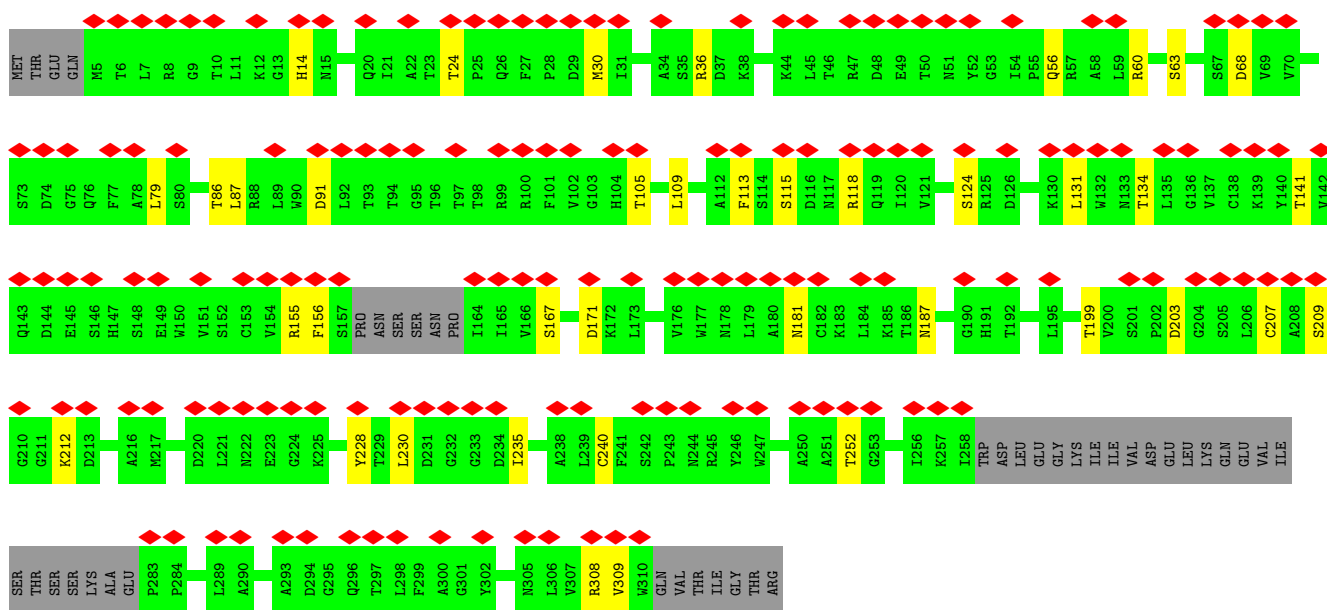
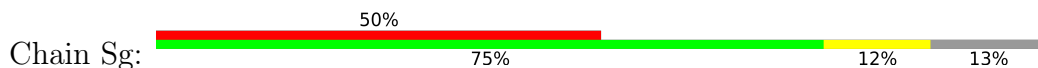

- Molecule 67: 40S ribosomal protein S2

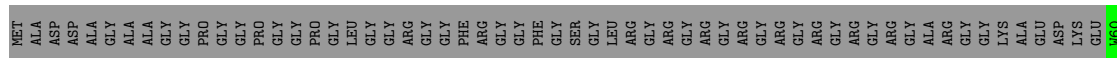

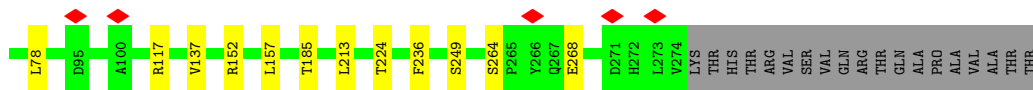

• Molecule 68: 40S ribosomal protein S6

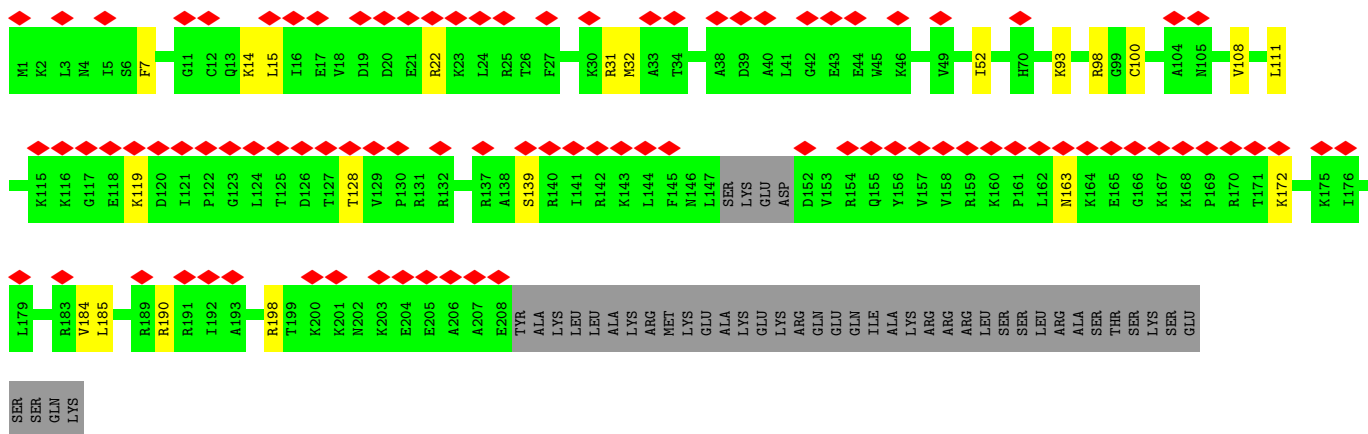
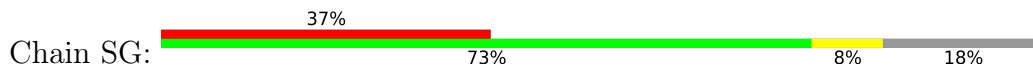

• Molecule 69: 40S ribosomal protein S9

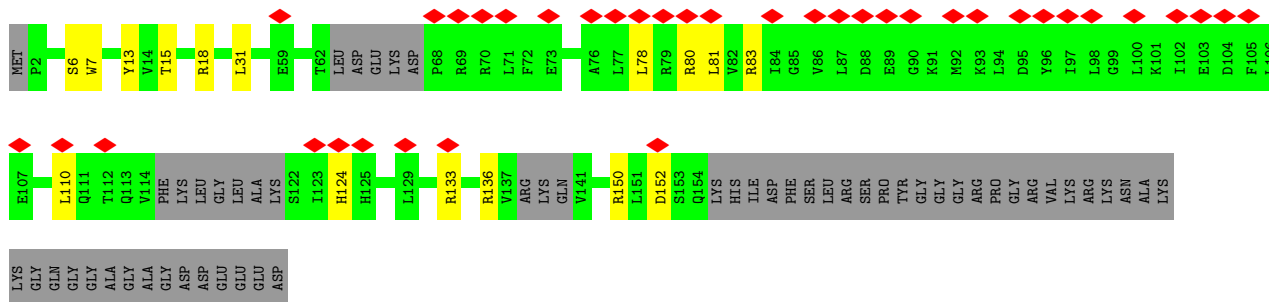

• Molecule 70: 40S ribosomal protein S13

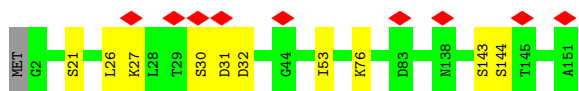

• Molecule 71: 40S ribosomal protein S14

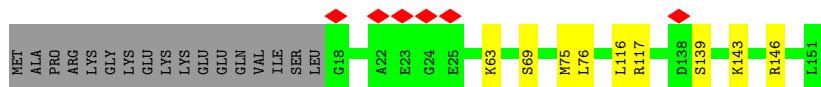
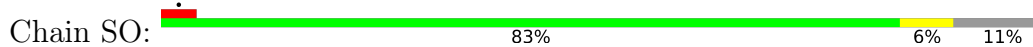

• Molecule 72: 40S ribosomal protein S15a



• Molecule 73: 40S ribosomal protein S24

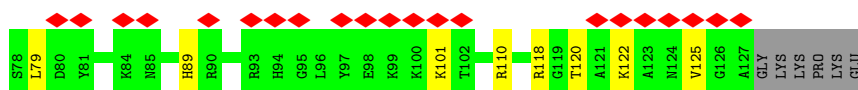
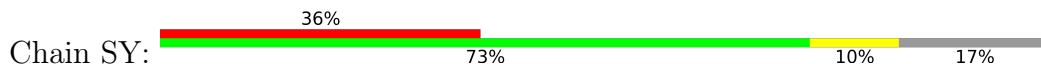

• Molecule 74: 40S ribosomal protein S25

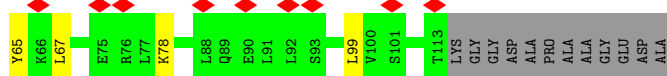
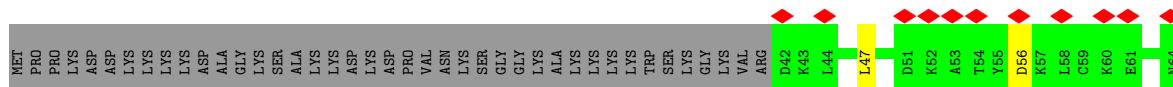

• Molecule 75: 40S ribosomal protein S27

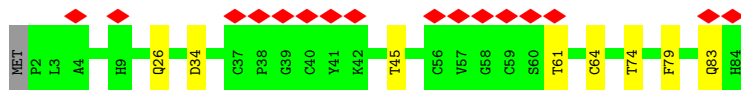
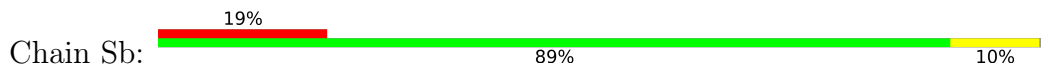

• Molecule 76: 40S ribosomal protein S30

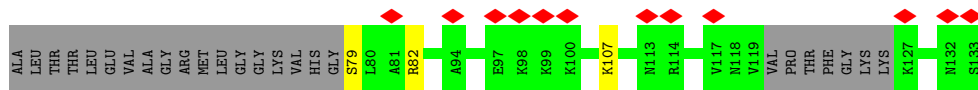

• Molecule 77: tRNA



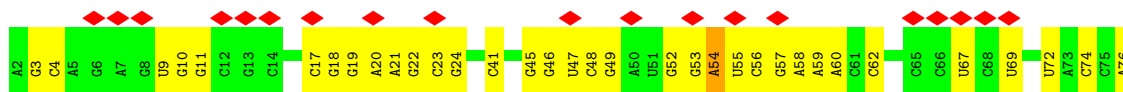

- Molecule 78: Ribosomal protein L39

Chain Ll: 92% 6%



## 4 Experimental information

Property	Value	Source
EM reconstruction method	SINGLE PARTICLE	Depositor
Imposed symmetry	POINT, Not provided	
Number of particles used	280287	Depositor
Resolution determination method	FSC 0.143 CUT-OFF	Depositor
CTF correction method	NONE	Depositor
Microscope	FEI TITAN KRIOS	Depositor
Voltage (kV)	300	Depositor
Electron dose ( $e^-/\text{\AA}^2$ )	60	Depositor
Minimum defocus (nm)	1000	Depositor
Maximum defocus (nm)	1500	Depositor
Magnification	Not provided	
Image detector	GATAN K2 SUMMIT (4k x 4k)	Depositor
Maximum map value	0.326	Depositor
Minimum map value	-0.162	Depositor
Average map value	0.000	Depositor
Map value standard deviation	0.012	Depositor
Recommended contour level	0.026	Depositor
Map size ( $\text{\AA}$ )	416.0, 416.0, 416.0	wwPDB
Map dimensions	400, 400, 400	wwPDB
Map angles ( $^\circ$ )	90.0, 90.0, 90.0	wwPDB
Pixel spacing ( $\text{\AA}$ )	1.04, 1.04, 1.04	Depositor

## 5 Model quality i

### 5.1 Standard geometry i

Bond lengths and bond angles in the following residue types are not validated in this section: ZN, MG

The Z score for a bond length (or angle) is the number of standard deviations the observed value is removed from the expected value. A bond length (or angle) with  $|Z| > 5$  is considered an outlier worth inspection. RMSZ is the root-mean-square of all Z scores of the bond lengths (or angles).

Mol	Chain	Bond lengths		Bond angles	
		RMSZ	# Z  >5	RMSZ	# Z  >5
1	LA	0.42	0/1936	0.54	0/2596
2	SA	0.29	0/1673	0.48	0/2275
3	LB	0.39	0/3269	0.54	2/4375 (0.0%)
4	SB	0.29	0/1756	0.48	0/2350
5	LC	0.37	0/2945	0.52	1/3953 (0.0%)
6	LD	0.38	0/2431	0.48	0/3256
7	LE	0.34	0/1910	0.50	0/2562
8	LF	0.40	0/1805	0.48	0/2408
9	LG	0.34	0/1880	0.46	0/2531
10	LH	0.35	0/1537	0.51	0/2065
11	LI	0.37	0/1671	0.46	0/2230
12	LJ	0.33	0/1394	0.50	0/1864
13	LL	0.36	0/1698	0.48	0/2274
14	LM	0.37	0/1146	0.46	0/1531
15	LN	0.42	0/1746	0.50	0/2338
16	LO	0.39	0/1670	0.48	0/2232
17	LP	0.38	0/1277	0.49	0/1712
18	LQ	0.40	0/1539	0.51	0/2053
19	LR	0.32	0/1473	0.43	0/1947
20	LS	0.41	0/1491	0.50	1/2000 (0.1%)
21	LT	0.39	0/1335	0.47	0/1781
22	LU	0.33	0/831	0.48	0/1115
23	LV	0.38	0/987	0.50	0/1324
24	LW	0.39	0/532	0.46	0/708
25	LX	0.36	0/984	0.45	0/1323
26	LY	0.36	0/1119	0.46	0/1488
27	LZ	0.38	0/1130	0.47	0/1507
28	La	0.41	0/1193	0.48	0/1593
29	Lb	0.32	0/821	0.43	0/1082
30	Lc	0.38	0/742	0.51	0/996
31	Ld	0.37	0/911	0.49	0/1227
32	Le	0.40	0/1071	0.48	0/1429

Mol	Chain	Bond lengths		Bond angles	
		RMSZ	# Z  >5	RMSZ	# Z  >5
33	Lf	0.41	0/895	0.54	0/1198
34	Lg	0.37	0/883	0.51	0/1178
35	Lh	0.33	0/1023	0.44	0/1350
36	Li	0.32	0/843	0.45	0/1115
37	Lj	0.40	0/720	0.50	0/952
38	Lk	0.34	0/574	0.44	0/760
39	Lm	0.35	0/425	0.45	0/564
40	Ln	0.30	0/240	0.44	0/305
41	Lo	0.37	0/855	0.49	0/1128
42	Lp	0.38	0/718	0.49	0/953
43	Lr	0.37	0/1009	0.48	0/1353
44	L5	0.71	1/84865 (0.0%)	0.87	62/132368 (0.0%)
45	L7	0.70	0/2858	0.82	0/4455
46	L8	0.69	0/3701	0.82	2/5766 (0.0%)
47	S2	0.43	0/39386	0.83	36/61368 (0.1%)
48	SD	0.28	0/1754	0.52	0/2362
49	SE	0.27	0/2092	0.50	0/2816
50	SF	0.27	0/1436	0.45	0/1930
51	SH	0.27	0/1470	0.48	0/1968
52	SI	0.28	0/1526	0.48	0/2038
53	SK	0.28	0/780	0.48	0/1046
54	SL	0.31	0/1130	0.49	0/1514
55	SP	0.29	0/1000	0.48	0/1335
56	SQ	0.30	0/1126	0.51	0/1506
57	SR	0.28	0/1078	0.48	0/1447
58	SS	0.28	0/1175	0.45	0/1575
59	ST	0.27	0/1108	0.45	0/1486
60	SU	0.27	0/762	0.50	0/1023
61	SV	0.28	0/616	0.49	0/825
62	SX	0.30	0/1097	0.50	0/1464
63	Sa	0.32	0/816	0.47	0/1093
64	Sc	0.28	0/418	0.57	0/562
65	Sd	0.29	0/466	0.42	0/618
66	Sg	0.26	0/2199	0.55	0/2989
67	SC	0.30	0/1712	0.48	0/2314
68	SG	0.27	0/1666	0.50	0/2222
69	SJ	0.26	0/1178	0.51	0/1574
70	SN	0.29	0/1232	0.43	0/1656
71	SO	0.29	0/1015	0.51	0/1361
72	SW	0.30	0/1051	0.49	0/1406
73	SY	0.27	0/907	0.46	0/1204
74	SZ	0.29	0/580	0.49	0/780
75	Sb	0.27	0/665	0.46	0/891



Mol	Chain	Bond lengths		Bond angles	
		RMSZ	# Z  >5	RMSZ	# Z  >5
76	Se	0.26	0/386	0.50	0/504
77	S6	0.38	0/1795	0.96	4/2798 (0.1%)
78	L1	0.65	0/454	0.60	0/599
All	All	0.54	1/221588 (0.0%)	0.74	108/325844 (0.0%)

Chiral center outliers are detected by calculating the chiral volume of a chiral center and verifying if the center is modelled as a planar moiety or with the opposite hand. A planarity outlier is detected by checking planarity of atoms in a peptide group, atoms in a mainchain group or atoms of a sidechain that are expected to be planar.

Mol	Chain	#Chirality outliers	#Planarity outliers
1	LA	0	1
3	LB	0	2
10	LH	0	1
12	LJ	0	1
14	LM	0	1
50	SF	0	1
59	ST	0	1
61	SV	0	1
68	SG	0	1
All	All	0	10

All (1) bond length outliers are listed below:

Mol	Chain	Res	Type	Atoms	Z	Observed(Å)	Ideal(Å)
44	L5	1338	A	N9-C4	-5.93	1.34	1.37

All (108) bond angle outliers are listed below:

Mol	Chain	Res	Type	Atoms	Z	Observed(°)	Ideal(°)
44	L5	486	C	C2-N1-C1'	9.59	129.35	118.80
47	S2	1454	C	N1-C2-O2	8.86	124.22	118.90
47	S2	1419	C	N1-C2-O2	8.82	124.19	118.90
47	S2	1454	C	C2-N1-C1'	8.63	128.30	118.80
44	L5	2464	C	N1-C2-O2	8.56	124.04	118.90
44	L5	416	G	O4'-C1'-N9	8.46	114.96	108.20
47	S2	1419	C	C2-N1-C1'	8.26	127.89	118.80
44	L5	2464	C	C2-N1-C1'	8.17	127.79	118.80
44	L5	486	C	C6-N1-C1'	-7.81	111.43	120.80
47	S2	1017	U	C2-N1-C1'	7.63	126.86	117.70
44	L5	4583	U	C2-N1-C1'	7.40	126.58	117.70
44	L5	4583	U	N1-C2-O2	7.27	127.89	122.80

*Continued on next page...*

*Continued from previous page...*

Mol	Chain	Res	Type	Atoms	Z	Observed(°)	Ideal(°)
44	L5	233	U	N3-C2-O2	-7.25	117.12	122.20
44	L5	233	U	N1-C2-O2	7.24	127.87	122.80
44	L5	100	C	C2-N1-C1'	7.18	126.70	118.80
47	S2	357	C	C2-N1-C1'	7.07	126.57	118.80
47	S2	1419	C	N3-C2-O2	-7.06	116.96	121.90
44	L5	2226	C	C2-N1-C1'	6.91	126.40	118.80
47	S2	1454	C	N3-C2-O2	-6.90	117.07	121.90
44	L5	2568	C	C2-N1-C1'	6.89	126.37	118.80
47	S2	357	C	N1-C2-O2	6.71	122.92	118.90
44	L5	2464	C	N3-C2-O2	-6.68	117.22	121.90
44	L5	1259	U	C2-N1-C1'	6.61	125.63	117.70
47	S2	294	C	C2-N1-C1'	6.59	126.06	118.80
44	L5	4583	U	N3-C2-O2	-6.57	117.60	122.20
44	L5	514	C	C2-N1-C1'	6.56	126.01	118.80
44	L5	1366	G	O4'-C1'-N9	6.47	113.38	108.20
44	L5	233	U	C2-N1-C1'	6.45	125.44	117.70
44	L5	1338	A	C2-N3-C4	-6.45	107.38	110.60
47	S2	1017	U	N1-C2-O2	6.42	127.29	122.80
47	S2	294	C	N1-C2-O2	6.40	122.74	118.90
44	L5	1005	C	C2-N1-C1'	-6.38	111.78	118.80
44	L5	3433	G	O4'-C1'-N9	6.34	113.27	108.20
77	S6	62	C	N3-C2-O2	-6.32	117.47	121.90
47	S2	1757	C	N3-C2-O2	-6.24	117.53	121.90
44	L5	486	C	N1-C2-O2	6.22	122.63	118.90
47	S2	1023	U	C2-N1-C1'	6.21	125.15	117.70
3	LB	268	ARG	NE-CZ-NH2	6.16	123.38	120.30
44	L5	2568	C	N1-C2-O2	6.14	122.59	118.90
47	S2	1017	U	N3-C2-O2	-6.14	117.90	122.20
77	S6	62	C	N1-C2-O2	6.09	122.56	118.90
44	L5	761	C	N3-C2-O2	-6.06	117.66	121.90
47	S2	1454	C	C6-N1-C1'	-6.05	113.54	120.80
44	L5	466	U	N3-C2-O2	-6.04	117.97	122.20
44	L5	761	C	N1-C2-O2	6.01	122.51	118.90
44	L5	1497	U	N3-C2-O2	-6.01	117.99	122.20
44	L5	2226	C	C6-N1-C2	-6.01	117.90	120.30
47	S2	1521	G	N3-C4-C5	-6.00	125.60	128.60
46	L8	51	U	N3-C2-O2	-5.94	118.04	122.20
47	S2	1521	G	C2-N3-C4	5.88	114.84	111.90
44	L5	2568	C	N3-C2-O2	-5.83	117.82	121.90
47	S2	639	C	C2-N1-C1'	5.82	125.20	118.80
77	S6	41	C	C2-N1-C1'	5.80	125.18	118.80
44	L5	466	U	N1-C2-O2	5.78	126.84	122.80

*Continued on next page...*

*Continued from previous page...*

Mol	Chain	Res	Type	Atoms	Z	Observed(°)	Ideal(°)
47	S2	1419	C	C6-N1-C2	-5.78	117.99	120.30
44	L5	923	G	C5-C6-O6	5.73	132.04	128.60
47	S2	518	C	C2-N1-C1'	5.66	125.03	118.80
47	S2	118	C	C2-N1-C1'	5.66	125.02	118.80
47	S2	1757	C	N1-C2-O2	5.65	122.29	118.90
44	L5	1050	C	N1-C2-O2	5.63	122.28	118.90
44	L5	2167	C	C2-N1-C1'	5.62	124.98	118.80
47	S2	1454	C	C6-N1-C2	-5.61	118.05	120.30
47	S2	1419	C	C6-N1-C1'	-5.61	114.06	120.80
44	L5	2464	C	C6-N1-C1'	-5.60	114.08	120.80
44	L5	4289	U	C2-N1-C1'	5.56	124.38	117.70
44	L5	923	G	N1-C6-O6	-5.53	116.58	119.90
44	L5	209	U	C2-N1-C1'	5.51	124.32	117.70
46	L8	51	U	N1-C2-O2	5.48	126.63	122.80
44	L5	1338	A	N3-C4-N9	-5.46	123.03	127.40
44	L5	2464	C	C6-N1-C2	-5.46	118.12	120.30
44	L5	4412	C	C2-N1-C1'	5.44	124.79	118.80
47	S2	593	C	C2-N1-C1'	5.42	124.76	118.80
44	L5	455	C	O4'-C1'-N1	5.40	112.52	108.20
44	L5	514	C	C6-N1-C1'	-5.36	114.37	120.80
47	S2	294	C	N3-C2-O2	-5.36	118.15	121.90
44	L5	2381	C	C2-N1-C1'	5.33	124.66	118.80
44	L5	1338	A	N3-C4-C5	5.32	130.52	126.80
44	L5	1071	C	C2-N1-C1'	5.31	124.64	118.80
44	L5	4427	C	C2-N1-C1'	5.31	124.64	118.80
44	L5	1005	C	C6-N1-C1'	5.30	127.16	120.80
44	L5	167	C	C2-N1-C1'	5.29	124.62	118.80
44	L5	496	C	N1-C2-O2	5.29	122.07	118.90
44	L5	1071	C	N1-C2-O2	5.28	122.07	118.90
77	S6	54	A	OP1-P-O3'	5.27	116.80	105.20
47	S2	357	C	N3-C2-O2	-5.27	118.21	121.90
47	S2	118	C	N1-C2-O2	5.26	122.06	118.90
44	L5	4210	U	C2-N1-C1'	5.26	124.02	117.70
44	L5	466	U	C2-N1-C1'	5.25	123.99	117.70
44	L5	1259	U	C6-N1-C1'	-5.24	113.86	121.20
47	S2	1273	C	N1-C2-O2	5.22	122.03	118.90
44	L5	3421	U	N3-C2-O2	-5.22	118.55	122.20
44	L5	3956	C	C2-N1-C1'	5.22	124.54	118.80
44	L5	1264	C	C2-N1-C1'	5.22	124.54	118.80
47	S2	688	C	C2-N1-C1'	5.19	124.51	118.80
47	S2	357	C	C6-N1-C2	-5.16	118.24	120.30
47	S2	1274	C	C6-N1-C2	-5.16	118.24	120.30

*Continued on next page...*

Continued from previous page...

Mol	Chain	Res	Type	Atoms	Z	Observed(°)	Ideal(°)
44	L5	1024	C	C2-N1-C1'	5.12	124.44	118.80
47	S2	1017	U	C6-N1-C1'	-5.11	114.05	121.20
20	LS	16	CYS	C-N-CA	-5.09	108.97	121.70
47	S2	593	C	N1-C2-O2	5.06	121.94	118.90
44	L5	100	C	C6-N1-C1'	-5.05	114.74	120.80
44	L5	4279	A	O4'-C1'-N9	5.05	112.24	108.20
5	LC	67	TRP	CA-CB-CG	5.05	123.30	113.70
44	L5	2429	G	P-O3'-C3'	5.03	125.73	119.70
44	L5	2285	G	C4-N9-C1'	5.02	133.03	126.50
3	LB	268	ARG	NE-CZ-NH1	-5.01	117.79	120.30
44	L5	3956	C	N3-C2-O2	-5.01	118.39	121.90
47	S2	1454	C	C5-C6-N1	5.01	123.50	121.00

There are no chirality outliers.

All (10) planarity outliers are listed below:

Mol	Chain	Res	Type	Group
1	LA	13	GLY	Peptide
3	LB	16	PHE	Peptide
3	LB	258	HIS	Peptide
10	LH	173	ARG	Peptide
12	LJ	173	ILE	Peptide
14	LM	32	ASP	Peptide
50	SF	78	MET	Peptide
68	SG	119	LYS	Peptide
59	ST	38	LYS	Peptide
61	SV	78	ILE	Peptide

## 5.2 Too-close contacts [i](#)

Due to software issues we are unable to calculate clashes - this section is therefore empty.

## 5.3 Torsion angles [i](#)

### 5.3.1 Protein backbone [i](#)

In the following table, the Percentiles column shows the percent Ramachandran outliers of the chain as a percentile score with respect to all PDB entries followed by that with respect to all EM entries.

The Analysed column shows the number of residues for which the backbone conformation was analysed, and the total number of residues.

Mol	Chain	Analysed	Favoured	Allowed	Outliers	Percentiles	
1	LA	246/257 (96%)	220 (89%)	26 (11%)	0	100	100
2	SA	205/295 (70%)	183 (89%)	22 (11%)	0	100	100
3	LB	395/403 (98%)	374 (95%)	21 (5%)	0	100	100
4	SB	211/264 (80%)	194 (92%)	17 (8%)	0	100	100
5	LC	360/419 (86%)	323 (90%)	36 (10%)	1 (0%)	41	70
6	LD	291/297 (98%)	271 (93%)	20 (7%)	0	100	100
7	LE	227/296 (77%)	201 (88%)	26 (12%)	0	100	100
8	LF	212/270 (78%)	200 (94%)	12 (6%)	0	100	100
9	LG	225/266 (85%)	207 (92%)	18 (8%)	0	100	100
10	LH	188/192 (98%)	172 (92%)	16 (8%)	0	100	100
11	LI	197/214 (92%)	193 (98%)	4 (2%)	0	100	100
12	LJ	169/178 (95%)	153 (90%)	16 (10%)	0	100	100
13	LL	204/211 (97%)	187 (92%)	17 (8%)	0	100	100
14	LM	134/217 (62%)	125 (93%)	9 (7%)	0	100	100
15	LN	201/204 (98%)	190 (94%)	10 (5%)	1 (0%)	29	59
16	LO	199/203 (98%)	192 (96%)	7 (4%)	0	100	100
17	LP	152/184 (83%)	142 (93%)	10 (7%)	0	100	100
18	LQ	185/188 (98%)	174 (94%)	11 (6%)	0	100	100
19	LR	172/196 (88%)	166 (96%)	6 (4%)	0	100	100
20	LS	173/176 (98%)	164 (95%)	9 (5%)	0	100	100
21	LT	158/160 (99%)	153 (97%)	5 (3%)	0	100	100
22	LU	98/128 (77%)	86 (88%)	12 (12%)	0	100	100
23	LV	128/140 (91%)	118 (92%)	10 (8%)	0	100	100
24	LW	60/157 (38%)	56 (93%)	4 (7%)	0	100	100
25	LX	116/156 (74%)	110 (95%)	6 (5%)	0	100	100
26	LY	130/145 (90%)	124 (95%)	6 (5%)	0	100	100
27	LZ	133/136 (98%)	123 (92%)	10 (8%)	0	100	100
28	La	145/148 (98%)	132 (91%)	13 (9%)	0	100	100
29	Lb	95/160 (59%)	88 (93%)	7 (7%)	0	100	100
30	Lc	92/115 (80%)	85 (92%)	7 (8%)	0	100	100

*Continued on next page...*

*Continued from previous page...*

Mol	Chain	Analysed	Favoured	Allowed	Outliers	Percentiles	
31	Ld	106/125 (85%)	98 (92%)	8 (8%)	0	100	100
32	Le	126/135 (93%)	115 (91%)	11 (9%)	0	100	100
33	Lf	107/110 (97%)	102 (95%)	5 (5%)	0	100	100
34	Lg	108/117 (92%)	107 (99%)	1 (1%)	0	100	100
35	Lh	120/123 (98%)	118 (98%)	2 (2%)	0	100	100
36	Li	100/105 (95%)	93 (93%)	7 (7%)	0	100	100
37	Lj	84/97 (87%)	78 (93%)	5 (6%)	1 (1%)	13	37
38	Lk	67/70 (96%)	64 (96%)	3 (4%)	0	100	100
39	Lm	49/128 (38%)	49 (100%)	0	0	100	100
40	Ln	23/25 (92%)	23 (100%)	0	0	100	100
41	Lo	101/106 (95%)	94 (93%)	7 (7%)	0	100	100
42	Lp	89/92 (97%)	85 (96%)	4 (4%)	0	100	100
43	Lr	122/137 (89%)	116 (95%)	6 (5%)	0	100	100
48	SD	220/243 (90%)	192 (87%)	28 (13%)	0	100	100
49	SE	256/263 (97%)	222 (87%)	33 (13%)	1 (0%)	34	64
50	SF	175/204 (86%)	158 (90%)	17 (10%)	0	100	100
51	SH	176/194 (91%)	148 (84%)	28 (16%)	0	100	100
52	SI	179/208 (86%)	167 (93%)	12 (7%)	0	100	100
53	SK	86/165 (52%)	75 (87%)	11 (13%)	0	100	100
54	SL	131/158 (83%)	118 (90%)	13 (10%)	0	100	100
55	SP	116/145 (80%)	106 (91%)	10 (9%)	0	100	100
56	SQ	137/146 (94%)	117 (85%)	20 (15%)	0	100	100
57	SR	129/135 (96%)	117 (91%)	12 (9%)	0	100	100
58	SS	138/152 (91%)	120 (87%)	18 (13%)	0	100	100
59	ST	138/145 (95%)	126 (91%)	12 (9%)	0	100	100
60	SU	93/119 (78%)	84 (90%)	9 (10%)	0	100	100
61	SV	78/83 (94%)	71 (91%)	6 (8%)	1 (1%)	12	34
62	SX	137/143 (96%)	125 (91%)	12 (9%)	0	100	100
63	Sa	98/115 (85%)	90 (92%)	8 (8%)	0	100	100
64	Sc	52/69 (75%)	41 (79%)	11 (21%)	0	100	100
65	Sd	52/56 (93%)	47 (90%)	5 (10%)	0	100	100

*Continued on next page...*

Continued from previous page...

Mol	Chain	Analysed	Favoured	Allowed	Outliers	Percentiles	
66	Sg	270/317 (85%)	213 (79%)	57 (21%)	0	100	100
67	SC	214/293 (73%)	199 (93%)	14 (6%)	1 (0%)	29	59
68	SG	200/249 (80%)	180 (90%)	20 (10%)	0	100	100
69	SJ	130/194 (67%)	115 (88%)	15 (12%)	0	100	100
70	SN	148/151 (98%)	142 (96%)	6 (4%)	0	100	100
71	SO	132/151 (87%)	116 (88%)	16 (12%)	0	100	100
72	SW	127/130 (98%)	118 (93%)	9 (7%)	0	100	100
73	SY	108/133 (81%)	93 (86%)	15 (14%)	0	100	100
74	SZ	70/125 (56%)	59 (84%)	11 (16%)	0	100	100
75	Sb	81/84 (96%)	74 (91%)	7 (9%)	0	100	100
76	Se	44/133 (33%)	38 (86%)	6 (14%)	0	100	100
78	Ll	48/51 (94%)	46 (96%)	2 (4%)	0	100	100
All	All	10666/12499 (85%)	9765 (92%)	895 (8%)	6 (0%)	54	80

All (6) Ramachandran outliers are listed below:

Mol	Chain	Res	Type
61	SV	79	VAL
37	Lj	21	ARG
49	SE	248	ILE
67	SC	78	LEU
15	LN	84	PRO
5	LC	232	VAL

### 5.3.2 Protein sidechains [i](#)

In the following table, the Percentiles column shows the percent sidechain outliers of the chain as a percentile score with respect to all PDB entries followed by that with respect to all EM entries.

The Analysed column shows the number of residues for which the sidechain conformation was analysed, and the total number of residues.

Mol	Chain	Analysed	Rotameric	Outliers	Percentiles	
1	LA	190/199 (96%)	181 (95%)	9 (5%)	26	57
2	SA	173/242 (72%)	157 (91%)	16 (9%)	9	26
3	LB	344/348 (99%)	332 (96%)	12 (4%)	36	68

Continued on next page...

*Continued from previous page...*

Mol	Chain	Analysed	Rotameric	Outliers	Percentiles	
4	SB	194/229 (85%)	185 (95%)	9 (5%)	27	58
5	LC	304/348 (87%)	279 (92%)	25 (8%)	11	31
6	LD	245/249 (98%)	231 (94%)	14 (6%)	20	49
7	LE	208/256 (81%)	193 (93%)	15 (7%)	14	37
8	LF	185/234 (79%)	180 (97%)	5 (3%)	44	77
9	LG	197/223 (88%)	180 (91%)	17 (9%)	10	29
10	LH	169/171 (99%)	156 (92%)	13 (8%)	13	34
11	LI	171/181 (94%)	162 (95%)	9 (5%)	22	52
12	LJ	144/149 (97%)	132 (92%)	12 (8%)	11	31
13	LL	173/178 (97%)	156 (90%)	17 (10%)	8	23
14	LM	116/157 (74%)	112 (97%)	4 (3%)	37	69
15	LN	171/172 (99%)	166 (97%)	5 (3%)	42	74
16	LO	172/173 (99%)	162 (94%)	10 (6%)	20	48
17	LP	135/163 (83%)	124 (92%)	11 (8%)	11	32
18	LQ	164/165 (99%)	160 (98%)	4 (2%)	49	80
19	LR	154/175 (88%)	144 (94%)	10 (6%)	17	43
20	LS	155/156 (99%)	145 (94%)	10 (6%)	17	43
21	LT	140/140 (100%)	132 (94%)	8 (6%)	20	49
22	LU	90/114 (79%)	83 (92%)	7 (8%)	12	33
23	LV	100/107 (94%)	95 (95%)	5 (5%)	24	55
24	LW	54/126 (43%)	54 (100%)	0	100	100
25	LX	106/133 (80%)	100 (94%)	6 (6%)	20	49
26	LY	123/135 (91%)	113 (92%)	10 (8%)	11	32
27	LZ	117/118 (99%)	111 (95%)	6 (5%)	24	54
28	La	120/121 (99%)	112 (93%)	8 (7%)	16	41
29	Lb	83/124 (67%)	75 (90%)	8 (10%)	8	24
30	Lc	79/97 (81%)	75 (95%)	4 (5%)	24	54
31	Ld	99/110 (90%)	96 (97%)	3 (3%)	41	73
32	Le	114/121 (94%)	111 (97%)	3 (3%)	46	78
33	Lf	88/89 (99%)	82 (93%)	6 (7%)	16	40
34	Lg	94/100 (94%)	89 (95%)	5 (5%)	22	52

*Continued on next page...*



Continued from previous page...

Mol	Chain	Analysed	Rotameric	Outliers	Percentiles	
35	Lh	109/110 (99%)	106 (97%)	3 (3%)	43	76
36	Li	86/89 (97%)	79 (92%)	7 (8%)	11	32
37	Lj	73/80 (91%)	68 (93%)	5 (7%)	16	40
38	Lk	64/65 (98%)	62 (97%)	2 (3%)	40	72
39	Lm	47/116 (40%)	47 (100%)	0	100	100
40	Ln	24/24 (100%)	23 (96%)	1 (4%)	30	62
41	Lo	91/94 (97%)	85 (93%)	6 (7%)	16	42
42	Lp	74/75 (99%)	72 (97%)	2 (3%)	44	77
43	Lr	108/121 (89%)	104 (96%)	4 (4%)	34	66
48	SD	186/202 (92%)	170 (91%)	16 (9%)	10	29
49	SE	221/225 (98%)	196 (89%)	25 (11%)	6	17
50	SF	152/170 (89%)	136 (90%)	16 (10%)	7	20
51	SH	161/174 (92%)	143 (89%)	18 (11%)	6	18
52	SI	159/180 (88%)	140 (88%)	19 (12%)	5	15
53	SK	81/136 (60%)	73 (90%)	8 (10%)	8	22
54	SL	123/142 (87%)	109 (89%)	14 (11%)	5	17
55	SP	107/130 (82%)	103 (96%)	4 (4%)	34	66
56	SQ	115/121 (95%)	103 (90%)	12 (10%)	7	20
57	SR	119/121 (98%)	102 (86%)	17 (14%)	3	9
58	SS	122/132 (92%)	111 (91%)	11 (9%)	9	27
59	ST	110/115 (96%)	103 (94%)	7 (6%)	17	44
60	SU	88/107 (82%)	75 (85%)	13 (15%)	3	9
61	SV	64/67 (96%)	61 (95%)	3 (5%)	26	57
62	SX	111/115 (96%)	101 (91%)	10 (9%)	9	27
63	Sa	87/98 (89%)	77 (88%)	10 (12%)	5	17
64	Sc	48/62 (77%)	43 (90%)	5 (10%)	7	20
65	Sd	48/49 (98%)	45 (94%)	3 (6%)	18	44
66	Sg	237/275 (86%)	198 (84%)	39 (16%)	2	6
67	SC	182/224 (81%)	171 (94%)	11 (6%)	19	47
68	SG	178/218 (82%)	158 (89%)	20 (11%)	6	18
69	SJ	126/168 (75%)	110 (87%)	16 (13%)	4	13

Continued on next page...

*Continued from previous page...*

Mol	Chain	Analysed	Rotameric	Outliers	Percentiles	
70	SN	130/131 (99%)	120 (92%)	10 (8%)	13	34
71	SO	104/119 (87%)	95 (91%)	9 (9%)	10	28
72	SW	112/113 (99%)	103 (92%)	9 (8%)	12	32
73	SY	93/115 (81%)	80 (86%)	13 (14%)	3	10
74	SZ	64/103 (62%)	58 (91%)	6 (9%)	8	25
75	Sb	75/76 (99%)	67 (89%)	8 (11%)	6	19
76	Se	39/106 (37%)	36 (92%)	3 (8%)	13	34
78	Ll	47/48 (98%)	44 (94%)	3 (6%)	17	44
All	All	9336/10619 (88%)	8642 (93%)	694 (7%)	17	36

All (694) residues with a non-rotameric sidechain are listed below:

Mol	Chain	Res	Type
1	LA	15	VAL
1	LA	36	GLU
1	LA	114	CYS
1	LA	147	ARG
1	LA	162	ASN
1	LA	169	VAL
1	LA	223	SER
1	LA	228	ASP
1	LA	237	LEU
2	SA	10	MET
2	SA	12	GLU
2	SA	16	LEU
2	SA	23	THR
2	SA	28	THR
2	SA	43	SER
2	SA	82	THR
2	SA	97	THR
2	SA	99	ILE
2	SA	138	SER
2	SA	140	VAL
2	SA	141	ASN
2	SA	152	SER
2	SA	178	LEU
2	SA	196	GLU
2	SA	198	MET
3	LB	22	SER

*Continued on next page...*

*Continued from previous page...*

<b>Mol</b>	<b>Chain</b>	<b>Res</b>	<b>Type</b>
3	LB	87	VAL
3	LB	101	THR
3	LB	108	GLU
3	LB	138	GLN
3	LB	140	ASP
3	LB	155	LYS
3	LB	220	ILE
3	LB	243	LYS
3	LB	258	HIS
3	LB	268	ARG
3	LB	392	LEU
4	SB	38	MET
4	SB	55	THR
4	SB	59	SER
4	SB	71	LEU
4	SB	103	MET
4	SB	151	ARG
4	SB	177	GLN
4	SB	184	VAL
4	SB	191	ASP
5	LC	3	CYS
5	LC	56	GLU
5	LC	62	THR
5	LC	63	SER
5	LC	67	TRP
5	LC	80	ARG
5	LC	87	SER
5	LC	95	MET
5	LC	100	ARG
5	LC	110	ARG
5	LC	122	TYR
5	LC	131	SER
5	LC	144	ILE
5	LC	154	VAL
5	LC	156	ASP
5	LC	157	LYS
5	LC	186	SER
5	LC	188	ARG
5	LC	189	MET
5	LC	214	ASP
5	LC	234	LYS
5	LC	259	LYS

*Continued on next page...*

*Continued from previous page...*

<b>Mol</b>	<b>Chain</b>	<b>Res</b>	<b>Type</b>
5	LC	290	SER
5	LC	295	SER
5	LC	355	GLU
6	LD	7	VAL
6	LD	34	LYS
6	LD	37	VAL
6	LD	86	TYR
6	LD	93	THR
6	LD	143	THR
6	LD	144	CYS
6	LD	214	GLU
6	LD	216	GLU
6	LD	222	GLN
6	LD	235	MET
6	LD	270	LYS
6	LD	272	SER
6	LD	291	GLN
7	LE	63	ARG
7	LE	103	THR
7	LE	109	ASN
7	LE	117	LEU
7	LE	123	TYR
7	LE	138	LYS
7	LE	183	VAL
7	LE	202	VAL
7	LE	228	LYS
7	LE	231	ARG
7	LE	242	ASP
7	LE	246	GLU
7	LE	252	GLU
7	LE	263	LEU
7	LE	281	SER
8	LF	124	SER
8	LF	174	GLU
8	LF	201	LEU
8	LF	209	MET
8	LF	254	ASP
9	LG	52	THR
9	LG	53	ARG
9	LG	88	ASP
9	LG	91	THR
9	LG	101	LYS

*Continued on next page...*

*Continued from previous page...*

<b>Mol</b>	<b>Chain</b>	<b>Res</b>	<b>Type</b>
9	LG	111	LYS
9	LG	114	LEU
9	LG	117	ARG
9	LG	150	LYS
9	LG	170	LEU
9	LG	201	THR
9	LG	206	GLN
9	LG	217	LYS
9	LG	229	ARG
9	LG	231	ASP
9	LG	259	LYS
9	LG	261	LEU
10	LH	1	MET
10	LH	14	GLU
10	LH	16	VAL
10	LH	21	LYS
10	LH	23	ARG
10	LH	51	LYS
10	LH	54	ARG
10	LH	111	LEU
10	LH	135	SER
10	LH	137	SER
10	LH	140	GLN
10	LH	141	LYS
10	LH	143	GLU
11	LI	21	ARG
11	LI	43	VAL
11	LI	66	GLU
11	LI	101	LYS
11	LI	125	THR
11	LI	143	GLN
11	LI	183	ASP
11	LI	184	MET
11	LI	197	VAL
12	LJ	15	LEU
12	LJ	41	GLU
12	LJ	47	THR
12	LJ	72	CYS
12	LJ	85	LYS
12	LJ	90	ARG
12	LJ	122	SER
12	LJ	147	ARG

*Continued on next page...*

*Continued from previous page...*

<b>Mol</b>	<b>Chain</b>	<b>Res</b>	<b>Type</b>
12	LJ	150	CYS
12	LJ	154	LYS
12	LJ	168	GLN
12	LJ	171	ASP
13	LL	16	LYS
13	LL	45	ARG
13	LL	64	VAL
13	LL	66	TYR
13	LL	67	HIS
13	LL	70	VAL
13	LL	94	ILE
13	LL	103	ARG
13	LL	109	SER
13	LL	132	SER
13	LL	140	SER
13	LL	145	LYS
13	LL	150	LEU
13	LL	161	TYR
13	LL	167	ARG
13	LL	200	LYS
13	LL	206	ASP
14	LM	25	VAL
14	LM	78	GLU
14	LM	84	THR
14	LM	135	ILE
15	LN	5	LYS
15	LN	50	ARG
15	LN	75	VAL
15	LN	100	SER
15	LN	148	THR
16	LO	31	ARG
16	LO	43	ILE
16	LO	94	ARG
16	LO	105	LEU
16	LO	117	ARG
16	LO	141	LEU
16	LO	145	VAL
16	LO	153	THR
16	LO	173	GLN
16	LO	203	VAL
17	LP	10	ASN
17	LP	14	SER

*Continued on next page...*

*Continued from previous page...*

<b>Mol</b>	<b>Chain</b>	<b>Res</b>	<b>Type</b>
17	LP	16	LYS
17	LP	17	SER
17	LP	20	SER
17	LP	24	VAL
17	LP	57	CYS
17	LP	79	THR
17	LP	93	HIS
17	LP	95	LEU
17	LP	99	GLU
18	LQ	14	ARG
18	LQ	27	LEU
18	LQ	41	SER
18	LQ	68	ARG
19	LR	13	SER
19	LR	29	THR
19	LR	36	ASN
19	LR	91	GLU
19	LR	106	LEU
19	LR	140	GLU
19	LR	152	LYS
19	LR	162	ARG
19	LR	172	ARG
19	LR	173	ARG
20	LS	19	THR
20	LS	36	ASN
20	LS	48	VAL
20	LS	82	LEU
20	LS	90	THR
20	LS	95	ARG
20	LS	118	ARG
20	LS	148	SER
20	LS	158	VAL
20	LS	169	THR
21	LT	27	LEU
21	LT	36	LYS
21	LT	45	MET
21	LT	76	VAL
21	LT	99	SER
21	LT	104	SER
21	LT	117	LYS
21	LT	147	GLU
22	LU	25	CYS

*Continued on next page...*

*Continued from previous page...*

<b>Mol</b>	<b>Chain</b>	<b>Res</b>	<b>Type</b>
22	LU	33	ILE
22	LU	40	GLU
22	LU	55	ASN
22	LU	62	THR
22	LU	63	ILE
22	LU	71	THR
23	LV	41	SER
23	LV	48	ARG
23	LV	67	LYS
23	LV	71	GLU
23	LV	72	LEU
25	LX	85	SER
25	LX	89	LYS
25	LX	118	ASP
25	LX	119	ILE
25	LX	120	ASP
25	LX	131	ASP
26	LY	12	SER
26	LY	52	ASP
26	LY	55	VAL
26	LY	74	TYR
26	LY	91	ASN
26	LY	93	THR
26	LY	113	LYS
26	LY	115	ARG
26	LY	119	LEU
26	LY	132	LYS
27	LZ	34	SER
27	LZ	36	ARG
27	LZ	59	LYS
27	LZ	91	LEU
27	LZ	100	VAL
27	LZ	123	LYS
28	La	3	SER
28	La	12	ARG
28	La	58	MET
28	La	75	LEU
28	La	95	THR
28	La	97	VAL
28	La	130	SER
28	La	140	VAL
29	Lb	15	LYS

*Continued on next page...*



*Continued from previous page...*

<b>Mol</b>	<b>Chain</b>	<b>Res</b>	<b>Type</b>
29	Lb	18	ARG
29	Lb	33	LYS
29	Lb	38	LYS
29	Lb	55	LYS
29	Lb	107	ARG
29	Lb	115	ARG
29	Lb	117	CYS
30	Lc	22	MET
30	Lc	28	VAL
30	Lc	98	ASP
30	Lc	106	ARG
31	Ld	95	ASP
31	Ld	101	LYS
31	Ld	123	ASP
32	Le	17	THR
32	Le	108	ARG
32	Le	118	LEU
33	Lf	7	CYS
33	Lf	25	THR
33	Lf	37	ASP
33	Lf	85	ARG
33	Lf	87	LYS
33	Lf	89	ARG
34	Lg	17	SER
34	Lg	20	THR
34	Lg	61	PRO
34	Lg	69	LYS
34	Lg	73	HIS
35	Lh	14	LYS
35	Lh	37	THR
35	Lh	45	SER
36	Li	3	LEU
36	Li	22	SER
36	Li	34	THR
36	Li	46	GLU
36	Li	62	LYS
36	Li	66	ASP
36	Li	91	SER
37	Lj	14	LYS
37	Lj	32	SER
37	Lj	46	LYS
37	Lj	55	ARG

*Continued on next page...*

*Continued from previous page...*

<b>Mol</b>	<b>Chain</b>	<b>Res</b>	<b>Type</b>
37	Lj	85	LYS
38	Lk	16	ARG
38	Lk	40	ARG
40	Ln	9	ARG
41	Lo	6	LYS
41	Lo	26	TYR
41	Lo	77	CYS
41	Lo	79	SER
41	Lo	87	ARG
41	Lo	99	ARG
42	Lp	63	THR
42	Lp	75	SER
43	Lr	22	LYS
43	Lr	35	ARG
43	Lr	56	ASP
43	Lr	105	ASP
48	SD	6	SER
48	SD	20	GLU
48	SD	22	ASN
48	SD	31	GLU
48	SD	34	TYR
48	SD	46	THR
48	SD	59	LEU
48	SD	74	GLN
48	SD	90	LYS
48	SD	91	VAL
48	SD	97	CYS
48	SD	132	LYS
48	SD	143	ARG
48	SD	149	SER
48	SD	193	ASP
48	SD	218	LEU
49	SE	51	ARG
49	SE	54	TYR
49	SE	61	VAL
49	SE	66	MET
49	SE	71	LYS
49	SE	93	ASP
49	SE	106	LYS
49	SE	108	ARG
49	SE	109	PHE
49	SE	113	ARG

*Continued on next page...*

*Continued from previous page...*

<b>Mol</b>	<b>Chain</b>	<b>Res</b>	<b>Type</b>
49	SE	117	GLU
49	SE	146	THR
49	SE	156	VAL
49	SE	158	ASP
49	SE	180	LEU
49	SE	188	ASN
49	SE	196	THR
49	SE	206	ASP
49	SE	207	VAL
49	SE	223	SER
49	SE	233	LYS
49	SE	237	SER
49	SE	251	GLU
49	SE	253	ASP
49	SE	256	LEU
50	SF	25	THR
50	SF	26	ASP
50	SF	29	GLN
50	SF	34	SER
50	SF	52	SER
50	SF	79	HIS
50	SF	85	LYS
50	SF	91	ARG
50	SF	111	VAL
50	SF	122	ARG
50	SF	140	ASP
50	SF	167	LYS
50	SF	175	ASP
50	SF	195	GLU
50	SF	196	LEU
50	SF	202	SER
51	SH	10	LYS
51	SH	15	LYS
51	SH	17	ASP
51	SH	24	SER
51	SH	40	LEU
51	SH	57	ARG
51	SH	60	ILE
51	SH	71	SER
51	SH	72	PHE
51	SH	75	ILE
51	SH	76	GLN

*Continued on next page...*

*Continued from previous page...*

<b>Mol</b>	<b>Chain</b>	<b>Res</b>	<b>Type</b>
51	SH	121	THR
51	SH	127	ASP
51	SH	131	GLU
51	SH	147	LYS
51	SH	158	LEU
51	SH	172	THR
51	SH	180	LEU
52	SI	5	ARG
52	SI	9	HIS
52	SI	17	LYS
52	SI	22	HIS
52	SI	26	LYS
52	SI	47	ARG
52	SI	78	ILE
52	SI	86	SER
52	SI	98	LYS
52	SI	100	CYS
52	SI	102	VAL
52	SI	116	HIS
52	SI	143	LYS
52	SI	154	LYS
52	SI	168	GLN
52	SI	170	LYS
52	SI	172	LEU
52	SI	197	PHE
52	SI	199	LEU
53	SK	1	MET
53	SK	37	ASP
53	SK	51	SER
53	SK	53	LYS
53	SK	60	GLU
53	SK	67	PHE
53	SK	80	ARG
53	SK	95	ARG
54	SL	8	ARG
54	SL	20	LYS
54	SL	39	ASN
54	SL	57	ASP
54	SL	66	VAL
54	SL	67	SER
54	SL	69	ARG
54	SL	74	SER

*Continued on next page...*

*Continued from previous page...*

<b>Mol</b>	<b>Chain</b>	<b>Res</b>	<b>Type</b>
54	SL	84	ARG
54	SL	85	THR
54	SL	100	ASN
54	SL	127	THR
54	SL	135	SER
54	SL	141	ASN
55	SP	12	PHE
55	SP	21	ASP
55	SP	46	ASN
55	SP	127	LYS
56	SQ	16	LYS
56	SQ	40	GLU
56	SQ	49	TYR
56	SQ	50	LYS
56	SQ	56	LEU
56	SQ	60	LYS
56	SQ	67	ASP
56	SQ	89	SER
56	SQ	92	LEU
56	SQ	113	ILE
56	SQ	118	THR
56	SQ	121	VAL
57	SR	6	THR
57	SR	11	LYS
57	SR	24	LEU
57	SR	26	ASN
57	SR	45	LYS
57	SR	63	ARG
57	SR	74	GLN
57	SR	77	GLU
57	SR	87	GLU
57	SR	95	ILE
57	SR	97	GLU
57	SR	102	THR
57	SR	105	MET
57	SR	110	ASP
57	SR	116	ASN
57	SR	123	THR
57	SR	124	VAL
58	SS	8	LYS
58	SS	13	LEU
58	SS	45	LEU

*Continued on next page...*

*Continued from previous page...*

<b>Mol</b>	<b>Chain</b>	<b>Res</b>	<b>Type</b>
58	SS	49	ASP
58	SS	53	THR
58	SS	85	ASN
58	SS	89	ASP
58	SS	91	LYS
58	SS	103	LEU
58	SS	105	ASN
58	SS	127	TRP
59	ST	5	THR
59	ST	33	TRP
59	ST	74	SER
59	ST	87	VAL
59	ST	111	LYS
59	ST	118	ASP
59	ST	142	ASN
60	SU	26	SER
60	SU	30	LYS
60	SU	31	SER
60	SU	32	LEU
60	SU	36	CYS
60	SU	48	LEU
60	SU	56	MET
60	SU	65	THR
60	SU	74	SER
60	SU	78	ASP
60	SU	96	GLU
60	SU	98	VAL
60	SU	103	SER
61	SV	38	GLU
61	SV	40	ASP
61	SV	41	ARG
62	SX	4	CYS
62	SX	19	ASP
62	SX	24	ASP
62	SX	36	LEU
62	SX	37	LYS
62	SX	70	VAL
62	SX	73	GLN
62	SX	105	PHE
62	SX	122	VAL
62	SX	140	ARG
63	Sa	2	THR

*Continued on next page...*

*Continued from previous page...*

<b>Mol</b>	<b>Chain</b>	<b>Res</b>	<b>Type</b>
63	Sa	26	CYS
63	Sa	52	ASP
63	Sa	54	SER
63	Sa	57	SER
63	Sa	59	PHE
63	Sa	63	VAL
63	Sa	80	HIS
63	Sa	88	SER
63	Sa	94	ASP
64	Sc	18	LEU
64	Sc	28	THR
64	Sc	39	SER
64	Sc	45	ASN
64	Sc	57	THR
65	Sd	6	LEU
65	Sd	9	SER
65	Sd	18	SER
66	Sg	14	HIS
66	Sg	24	THR
66	Sg	30	MET
66	Sg	36	ARG
66	Sg	56	GLN
66	Sg	60	ARG
66	Sg	63	SER
66	Sg	68	ASP
66	Sg	79	LEU
66	Sg	86	THR
66	Sg	87	LEU
66	Sg	91	ASP
66	Sg	105	THR
66	Sg	109	LEU
66	Sg	113	PHE
66	Sg	115	SER
66	Sg	118	ARG
66	Sg	124	SER
66	Sg	131	LEU
66	Sg	134	THR
66	Sg	141	THR
66	Sg	155	ARG
66	Sg	156	PHE
66	Sg	167	SER
66	Sg	171	ASP

*Continued on next page...*

*Continued from previous page...*

<b>Mol</b>	<b>Chain</b>	<b>Res</b>	<b>Type</b>
66	Sg	181	ASN
66	Sg	187	ASN
66	Sg	199	THR
66	Sg	203	ASP
66	Sg	207	CYS
66	Sg	209	SER
66	Sg	212	LYS
66	Sg	228	TYR
66	Sg	230	LEU
66	Sg	235	ILE
66	Sg	240	CYS
66	Sg	252	THR
66	Sg	308	ARG
66	Sg	309	VAL
67	SC	117	ARG
67	SC	137	VAL
67	SC	152	ARG
67	SC	157	LEU
67	SC	185	THR
67	SC	213	LEU
67	SC	224	THR
67	SC	236	PHE
67	SC	249	SER
67	SC	264	SER
67	SC	268	GLU
68	SG	7	PHE
68	SG	14	LYS
68	SG	15	LEU
68	SG	22	ARG
68	SG	31	ARG
68	SG	32	MET
68	SG	52	ILE
68	SG	93	LYS
68	SG	98	ARG
68	SG	100	CYS
68	SG	108	VAL
68	SG	111	LEU
68	SG	128	THR
68	SG	139	SER
68	SG	163	ASN
68	SG	172	LYS
68	SG	184	VAL

*Continued on next page...*



*Continued from previous page...*

<b>Mol</b>	<b>Chain</b>	<b>Res</b>	<b>Type</b>
68	SG	185	LEU
68	SG	190	ARG
68	SG	198	ARG
69	SJ	6	SER
69	SJ	7	TRP
69	SJ	13	TYR
69	SJ	15	THR
69	SJ	18	ARG
69	SJ	31	LEU
69	SJ	78	LEU
69	SJ	80	ARG
69	SJ	81	LEU
69	SJ	83	ARG
69	SJ	110	LEU
69	SJ	124	HIS
69	SJ	133	ARG
69	SJ	136	ARG
69	SJ	150	ARG
69	SJ	152	ASP
70	SN	21	SER
70	SN	26	LEU
70	SN	27	LYS
70	SN	30	SER
70	SN	31	ASP
70	SN	32	ASP
70	SN	53	ILE
70	SN	76	LYS
70	SN	143	SER
70	SN	144	SER
71	SO	63	LYS
71	SO	69	SER
71	SO	75	MET
71	SO	76	LEU
71	SO	116	LEU
71	SO	117	ARG
71	SO	139	SER
71	SO	143	LYS
71	SO	146	ARG
72	SW	20	ARG
72	SW	30	CYS
72	SW	55	ASP
72	SW	57	ARG

*Continued on next page...*

*Continued from previous page...*

<b>Mol</b>	<b>Chain</b>	<b>Res</b>	<b>Type</b>
72	SW	80	ASP
72	SW	84	LYS
72	SW	85	ASP
72	SW	90	GLN
72	SW	104	LEU
73	SY	38	THR
73	SY	51	THR
73	SY	53	ASP
73	SY	62	THR
73	SY	77	ASP
73	SY	79	LEU
73	SY	89	HIS
73	SY	101	LYS
73	SY	110	ARG
73	SY	118	ARG
73	SY	120	THR
73	SY	122	LYS
73	SY	125	VAL
74	SZ	47	LEU
74	SZ	56	ASP
74	SZ	65	TYR
74	SZ	67	LEU
74	SZ	78	LYS
74	SZ	99	LEU
75	Sb	26	GLN
75	Sb	34	ASP
75	Sb	45	THR
75	Sb	61	THR
75	Sb	64	CYS
75	Sb	74	THR
75	Sb	79	PHE
75	Sb	83	GLN
76	Se	79	SER
76	Se	82	ARG
76	Se	107	LYS
78	Ll	27	ILE
78	Ll	36	ARG
78	Ll	45	ARG

Sometimes sidechains can be flipped to improve hydrogen bonding and reduce clashes. All (156) such sidechains are listed below:

Mol	Chain	Res	Type
1	LA	50	HIS
1	LA	86	GLN
1	LA	97	ASN
1	LA	132	ASN
1	LA	162	ASN
1	LA	187	HIS
1	LA	194	ASN
1	LA	216	HIS
2	SA	81	ASN
2	SA	84	GLN
2	SA	141	ASN
2	SA	165	ASN
3	LB	42	HIS
3	LB	151	ASN
3	LB	184	GLN
3	LB	213	GLN
3	LB	289	GLN
3	LB	354	GLN
4	SB	186	ASN
5	LC	38	ASN
5	LC	50	GLN
5	LC	119	GLN
5	LC	169	GLN
5	LC	178	ASN
5	LC	329	ASN
5	LC	346	ASN
6	LD	9	ASN
6	LD	282	GLN
7	LE	198	HIS
7	LE	199	GLN
7	LE	219	HIS
7	LE	236	GLN
8	LF	228	ASN
9	LG	159	HIS
9	LG	206	GLN
10	LH	42	ASN
10	LH	78	GLN
10	LH	116	ASN
11	LI	14	ASN
11	LI	59	GLN
12	LJ	42	GLN
12	LJ	98	ASN
12	LJ	112	HIS

*Continued on next page...*

*Continued from previous page...*

<b>Mol</b>	<b>Chain</b>	<b>Res</b>	<b>Type</b>
13	LL	19	GLN
13	LL	115	GLN
13	LL	175	ASN
15	LN	196	ASN
15	LN	199	GLN
17	LP	21	ASN
17	LP	80	GLN
17	LP	97	ASN
17	LP	116	HIS
18	LQ	44	ASN
20	LS	36	ASN
20	LS	77	ASN
20	LS	122	HIS
21	LT	90	ASN
22	LU	50	ASN
23	LV	77	HIS
23	LV	135	ASN
24	LW	17	HIS
24	LW	50	ASN
25	LX	57	GLN
25	LX	93	ASN
25	LX	107	HIS
25	LX	111	GLN
26	LY	66	GLN
26	LY	96	HIS
27	LZ	78	ASN
28	La	28	HIS
28	La	34	ASN
28	La	66	ASN
28	La	120	GLN
29	Lb	7	HIS
29	Lb	19	ASN
29	Lb	58	GLN
31	Ld	69	ASN
31	Ld	79	ASN
32	Le	23	HIS
32	Le	34	ASN
32	Le	80	HIS
32	Le	117	GLN
33	Lf	56	ASN
34	Lg	3	GLN
35	Lh	107	GLN

*Continued on next page...*

*Continued from previous page...*

<b>Mol</b>	<b>Chain</b>	<b>Res</b>	<b>Type</b>
39	Lm	90	ASN
41	Lo	45	GLN
41	Lo	51	GLN
42	Lp	33	GLN
42	Lp	56	HIS
43	Lr	6	GLN
43	Lr	23	GLN
43	Lr	100	ASN
48	SD	22	ASN
48	SD	145	GLN
48	SD	165	ASN
48	SD	179	GLN
49	SE	50	ASN
49	SE	98	ASN
49	SE	112	HIS
49	SE	138	HIS
49	SE	157	ASN
50	SF	74	ASN
50	SF	82	ASN
50	SF	114	ASN
50	SF	148	ASN
51	SH	114	GLN
51	SH	165	ASN
52	SI	84	ASN
52	SI	168	GLN
53	SK	39	ASN
53	SK	44	HIS
53	SK	61	GLN
54	SL	83	GLN
55	SP	24	GLN
55	SP	41	GLN
55	SP	104	GLN
56	SQ	29	ASN
56	SQ	48	GLN
56	SQ	77	HIS
58	SS	11	HIS
58	SS	97	GLN
58	SS	101	ASN
58	SS	105	ASN
59	ST	12	GLN
59	ST	128	GLN
59	ST	142	ASN

*Continued on next page...*

*Continued from previous page...*

Mol	Chain	Res	Type
60	SU	81	GLN
62	SX	16	HIS
62	SX	23	HIS
62	SX	61	GLN
62	SX	77	ASN
62	SX	92	ASN
62	SX	110	HIS
63	Sa	17	HIS
64	Sc	29	GLN
66	Sg	15	ASN
66	Sg	76	GLN
66	Sg	187	ASN
66	Sg	191	HIS
68	SG	13	GLN
68	SG	81	HIS
68	SG	186	GLN
68	SG	197	GLN
69	SJ	113	GLN
71	SO	32	HIS
71	SO	103	ASN
72	SW	44	HIS
72	SW	98	GLN
73	SY	19	GLN
73	SY	85	ASN
73	SY	106	GLN
73	SY	112	ASN
74	SZ	106	GLN
75	Sb	83	GLN
76	Se	111	GLN

### 5.3.3 RNA [i](#)

Mol	Chain	Analysed	Backbone Outliers	Pucker Outliers
44	L5	3521/4731 (74%)	853 (24%)	19 (0%)
45	L7	119/120 (99%)	18 (15%)	0
46	L8	155/158 (98%)	32 (20%)	0
47	S2	1638/1870 (87%)	425 (25%)	9 (0%)
77	S6	74/75 (98%)	32 (43%)	4 (5%)
All	All	5507/6954 (79%)	1360 (24%)	32 (0%)

All (1360) RNA backbone outliers are listed below:

Mol	Chain	Res	Type
44	L5	4	G
44	L5	13	U
44	L5	17	A
44	L5	21	G
44	L5	25	A
44	L5	26	C
44	L5	27	C
44	L5	30	C
44	L5	39	A
44	L5	42	A
44	L5	48	G
44	L5	56	A
44	L5	59	A
44	L5	64	A
44	L5	65	A
44	L5	69	A
44	L5	71	C
44	L5	72	C
44	L5	73	A
44	L5	74	G
44	L5	91	G
44	L5	98	A
44	L5	104	G
44	L5	108	A
44	L5	109	G
44	L5	110	C
44	L5	117	C
44	L5	119	G
44	L5	120	A
44	L5	129	C
44	L5	133	C
44	L5	134	G
44	L5	135	U
44	L5	136	C
44	L5	139	G
44	L5	143	U
44	L5	144	G
44	L5	152	U
44	L5	157	U
44	L5	159	C
44	L5	165	A
44	L5	166	C
44	L5	170	C

*Continued on next page...*

*Continued from previous page...*

<b>Mol</b>	<b>Chain</b>	<b>Res</b>	<b>Type</b>
44	L5	172	C
44	L5	200	U
44	L5	203	U
44	L5	210	C
44	L5	217	C
44	L5	218	A
44	L5	220	C
44	L5	225	G
44	L5	234	G
44	L5	237	G
44	L5	257	G
44	L5	258	C
44	L5	260	G
44	L5	265	C
44	L5	266	G
44	L5	279	G
44	L5	296	U
44	L5	305	A
44	L5	315	U
44	L5	339	C
44	L5	343	A
44	L5	344	C
44	L5	352	A
44	L5	356	U
44	L5	362	A
44	L5	372	G
44	L5	380	U
44	L5	386	G
44	L5	408	G
44	L5	409	A
44	L5	410	G
44	L5	411	G
44	L5	417	A
44	L5	431	U
44	L5	432	A
44	L5	439	U
44	L5	448	C
44	L5	449	G
44	L5	452	G
44	L5	453	U
44	L5	455	C
44	L5	456	G

*Continued on next page...*



*Continued from previous page...*

<b>Mol</b>	<b>Chain</b>	<b>Res</b>	<b>Type</b>
44	L5	465	A
44	L5	466	U
44	L5	467	U
44	L5	487	C
44	L5	488	G
44	L5	493	U
44	L5	495	C
44	L5	496	C
44	L5	499	G
44	L5	510	G
44	L5	512	A
44	L5	513	U
44	L5	514	C
44	L5	515	U
44	L5	651	C
44	L5	652	G
44	L5	653	G
44	L5	655	G
44	L5	661	U
44	L5	672	G
44	L5	674	G
44	L5	675	A
44	L5	676	C
44	L5	677	C
44	L5	678	G
44	L5	689	G
44	L5	694	A
44	L5	695	C
44	L5	696	U
44	L5	704	U
44	L5	712	C
44	L5	714	C
44	L5	716	G
44	L5	738	G
44	L5	739	G
44	L5	746	C
44	L5	747	G
44	L5	748	G
44	L5	749	U
44	L5	750	G
44	L5	757	G
44	L5	761	C

*Continued on next page...*

*Continued from previous page...*

<b>Mol</b>	<b>Chain</b>	<b>Res</b>	<b>Type</b>
44	L5	765	G
44	L5	806	C
44	L5	808	G
44	L5	810	G
44	L5	811	U
44	L5	814	U
44	L5	815	A
44	L5	817	A
44	L5	818	G
44	L5	825	G
44	L5	831	G
44	L5	834	U
44	L5	835	U
44	L5	839	C
44	L5	840	G
44	L5	841	A
44	L5	843	U
44	L5	844	C
44	L5	857	A
44	L5	858	A
44	L5	859	G
44	L5	860	C
44	L5	872	C
44	L5	877	C
44	L5	880	U
44	L5	882	U
44	L5	884	C
44	L5	925	G
44	L5	926	G
44	L5	927	C
44	L5	931	G
44	L5	939	U
44	L5	951	A
44	L5	1005	C
44	L5	1006	G
44	L5	1007	G
44	L5	1008	A
44	L5	1011	G
44	L5	1012	U
44	L5	1013	C
44	L5	1016	C
44	L5	1018	G

*Continued on next page...*

*Continued from previous page...*

<b>Mol</b>	<b>Chain</b>	<b>Res</b>	<b>Type</b>
44	L5	1026	C
44	L5	1029	G
44	L5	1031	G
44	L5	1032	U
44	L5	1033	G
44	L5	1036	C
44	L5	1037	G
44	L5	1039	G
44	L5	1044	C
44	L5	1045	G
44	L5	1048	U
44	L5	1049	C
44	L5	1050	C
44	L5	1052	G
44	L5	1065	G
44	L5	1070	G
44	L5	1089	A
44	L5	1090	G
44	L5	1092	G
44	L5	1095	C
44	L5	1098	G
44	L5	1099	G
44	L5	1100	U
44	L5	1102	G
44	L5	1108	G
44	L5	1109	A
44	L5	1110	U
44	L5	1111	G
44	L5	1116	C
44	L5	1117	U
44	L5	1128	C
44	L5	1129	C
44	L5	1137	A
44	L5	1141	A
44	L5	1152	A
44	L5	1157	A
44	L5	1159	C
44	L5	1169	A
44	L5	1173	A
44	L5	1174	G
44	L5	1175	G
44	L5	1180	C

*Continued on next page...*

*Continued from previous page...*

<b>Mol</b>	<b>Chain</b>	<b>Res</b>	<b>Type</b>
44	L5	1181	G
44	L5	1192	G
44	L5	1193	C
44	L5	1194	C
44	L5	1195	G
44	L5	1196	U
44	L5	1202	A
44	L5	1209	G
44	L5	1212	A
44	L5	1215	G
44	L5	1219	C
44	L5	1220	C
44	L5	1222	C
44	L5	1223	C
44	L5	1226	G
44	L5	1234	A
44	L5	1249	G
44	L5	1250	C
44	L5	1253	C
44	L5	1256	C
44	L5	1258	G
44	L5	1259	U
44	L5	1260	C
44	L5	1261	C
44	L5	1265	G
44	L5	1294	C
44	L5	1296	G
44	L5	1297	C
44	L5	1298	G
44	L5	1307	G
44	L5	1311	A
44	L5	1312	G
44	L5	1316	G
44	L5	1328	U
44	L5	1330	G
44	L5	1339	A
44	L5	1348	A
44	L5	1361	A
44	L5	1375	G
44	L5	1376	G
44	L5	1377	A
44	L5	1380	C

*Continued on next page...*

*Continued from previous page...*

<b>Mol</b>	<b>Chain</b>	<b>Res</b>	<b>Type</b>
44	L5	1381	U
44	L5	1388	G
44	L5	1389	A
44	L5	1392	U
44	L5	1400	G
44	L5	1405	U
44	L5	1410	U
44	L5	1414	A
44	L5	1415	A
44	L5	1426	G
44	L5	1428	C
44	L5	1438	G
44	L5	1439	G
44	L5	1445	A
44	L5	1447	G
44	L5	1448	A
44	L5	1452	A
44	L5	1454	C
44	L5	1456	A
44	L5	1468	G
44	L5	1475	C
44	L5	1484	G
44	L5	1490	C
44	L5	1491	U
44	L5	1492	C
44	L5	1494	G
44	L5	1495	G
44	L5	1499	G
44	L5	1500	C
44	L5	1508	C
44	L5	1512	C
44	L5	1524	G
44	L5	1532	A
44	L5	1534	C
44	L5	1537	G
44	L5	1553	G
44	L5	1558	C
44	L5	1560	U
44	L5	1561	G
44	L5	1562	G
44	L5	1563	G
44	L5	1564	G

*Continued on next page...*

*Continued from previous page...*

<b>Mol</b>	<b>Chain</b>	<b>Res</b>	<b>Type</b>
44	L5	1565	C
44	L5	1566	C
44	L5	1567	G
44	L5	1568	A
44	L5	1569	A
44	L5	1570	A
44	L5	1571	C
44	L5	1572	G
44	L5	1573	A
44	L5	1575	C
44	L5	1588	C
44	L5	1590	A
44	L5	1600	G
44	L5	1607	A
44	L5	1618	G
44	L5	1623	C
44	L5	1624	G
44	L5	1625	U
44	L5	1639	G
44	L5	1640	A
44	L5	1645	G
44	L5	1658	G
44	L5	1672	G
44	L5	1684	C
44	L5	1685	U
44	L5	1693	G
44	L5	1695	A
44	L5	1696	C
44	L5	1700	A
44	L5	1701	C
44	L5	1720	A
44	L5	1721	U
44	L5	1722	G
44	L5	1723	C
44	L5	1724	C
44	L5	1725	G
44	L5	1728	G
44	L5	1731	C
44	L5	1734	C
44	L5	1735	A
44	L5	1739	C
44	L5	1751	G

*Continued on next page...*

*Continued from previous page...*

<b>Mol</b>	<b>Chain</b>	<b>Res</b>	<b>Type</b>
44	L5	1752	U
44	L5	1754	G
44	L5	1758	G
44	L5	1763	A
44	L5	1764	G
44	L5	1765	A
44	L5	1768	G
44	L5	1769	C
44	L5	1770	A
44	L5	1772	G
44	L5	1774	C
44	L5	1775	G
44	L5	1777	U
44	L5	1778	G
44	L5	1779	G
44	L5	1781	C
44	L5	1783	U
44	L5	1784	G
44	L5	1785	G
44	L5	1786	A
44	L5	1787	A
44	L5	1788	G
44	L5	1791	G
44	L5	1792	G
44	L5	1793	A
44	L5	1795	U
44	L5	1796	C
44	L5	1797	C
44	L5	1798	G
44	L5	1801	A
44	L5	1802	A
44	L5	1803	G
44	L5	1804	G
44	L5	1805	A
44	L5	1806	G
44	L5	1809	U
44	L5	1810	G
44	L5	1811	U
44	L5	1812	A
44	L5	1813	A
44	L5	1814	C
44	L5	1815	A

*Continued on next page...*

*Continued from previous page...*

<b>Mol</b>	<b>Chain</b>	<b>Res</b>	<b>Type</b>
44	L5	1816	A
44	L5	1817	C
44	L5	1819	C
44	L5	1821	C
44	L5	1822	C
44	L5	1823	U
44	L5	1824	G
44	L5	1826	C
44	L5	1827	G
44	L5	1828	A
44	L5	1829	A
44	L5	1836	A
44	L5	1837	G
44	L5	1847	U
44	L5	1848	G
44	L5	1849	G
44	L5	1851	U
44	L5	1858	G
44	L5	1859	G
44	L5	1872	A
44	L5	1874	A
44	L5	1887	C
44	L5	1891	A
44	L5	1892	G
44	L5	1903	A
44	L5	1904	C
44	L5	1914	G
44	L5	2013	C
44	L5	2015	C
44	L5	2016	G
44	L5	2017	C
44	L5	2018	G
44	L5	2019	G
44	L5	2035	G
44	L5	2046	C
44	L5	2054	G
44	L5	2057	A
44	L5	2058	G
44	L5	2063	G
44	L5	2070	A
44	L5	2084	G
44	L5	2090	G

*Continued on next page...*



*Continued from previous page...*

<b>Mol</b>	<b>Chain</b>	<b>Res</b>	<b>Type</b>
44	L5	2102	G
44	L5	2103	C
44	L5	2105	G
44	L5	2108	C
44	L5	2139	A
44	L5	2152	A
44	L5	2153	A
44	L5	2154	G
44	L5	2159	G
44	L5	2165	U
44	L5	2167	C
44	L5	2168	C
44	L5	2174	A
44	L5	2178	G
44	L5	2179	C
44	L5	2182	U
44	L5	2193	U
44	L5	2198	C
44	L5	2204	U
44	L5	2207	G
44	L5	2221	C
44	L5	2222	C
44	L5	2224	U
44	L5	2226	C
44	L5	2227	C
44	L5	2228	G
44	L5	2232	G
44	L5	2235	C
44	L5	2237	G
44	L5	2238	G
44	L5	2241	A
44	L5	2242	U
44	L5	2245	C
44	L5	2246	C
44	L5	2247	U
44	L5	2248	C
44	L5	2250	G
44	L5	2252	U
44	L5	2253	G
44	L5	2255	C
44	L5	2260	G
44	L5	2261	C

*Continued on next page...*

*Continued from previous page...*

<b>Mol</b>	<b>Chain</b>	<b>Res</b>	<b>Type</b>
44	L5	2262	C
44	L5	2263	G
44	L5	2264	A
44	L5	2269	A
44	L5	2270	A
44	L5	2271	G
44	L5	2301	G
44	L5	2303	G
44	L5	2304	G
44	L5	2311	U
44	L5	2313	G
44	L5	2314	G
44	L5	2318	C
44	L5	2319	G
44	L5	2320	C
44	L5	2321	G
44	L5	2323	G
44	L5	2324	G
44	L5	2327	A
44	L5	2337	C
44	L5	2341	A
44	L5	2355	A
44	L5	2372	G
44	L5	2381	C
44	L5	2407	C
44	L5	2416	G
44	L5	2423	C
44	L5	2430	A
44	L5	2435	G
44	L5	2441	U
44	L5	2448	G
44	L5	2449	A
44	L5	2450	A
44	L5	2459	G
44	L5	2462	U
44	L5	2463	C
44	L5	2464	C
44	L5	2465	G
44	L5	2466	G
44	L5	2468	G
44	L5	2480	G
44	L5	2486	G

*Continued on next page...*

*Continued from previous page...*

<b>Mol</b>	<b>Chain</b>	<b>Res</b>	<b>Type</b>
44	L5	2493	C
44	L5	2497	A
44	L5	2508	G
44	L5	2510	G
44	L5	2514	G
44	L5	2515	U
44	L5	2517	U
44	L5	2523	U
44	L5	2524	C
44	L5	2541	A
44	L5	2542	U
44	L5	2544	U
44	L5	2557	U
44	L5	2562	G
44	L5	2568	C
44	L5	2569	A
44	L5	2579	A
44	L5	2580	U
44	L5	2581	G
44	L5	2583	U
44	L5	2588	C
44	L5	2603	A
44	L5	2609	G
44	L5	2621	C
44	L5	2631	G
44	L5	2646	C
44	L5	2649	A
44	L5	2654	U
44	L5	2656	G
44	L5	2657	G
44	L5	2659	C
44	L5	3243	G
44	L5	3245	C
44	L5	3246	G
44	L5	3248	C
44	L5	3249	G
44	L5	3250	C
44	L5	3251	C
44	L5	3252	U
44	L5	3253	A
44	L5	3254	G
44	L5	3261	A

*Continued on next page...*

*Continued from previous page...*

<b>Mol</b>	<b>Chain</b>	<b>Res</b>	<b>Type</b>
44	L5	3262	C
44	L5	3272	G
44	L5	3273	U
44	L5	3275	C
44	L5	3277	G
44	L5	3283	G
44	L5	3287	A
44	L5	3292	A
44	L5	3301	U
44	L5	3303	A
44	L5	3305	A
44	L5	3319	A
44	L5	3327	C
44	L5	3330	C
44	L5	3358	C
44	L5	3361	U
44	L5	3362	G
44	L5	3367	G
44	L5	3370	U
44	L5	3371	G
44	L5	3393	A
44	L5	3404	A
44	L5	3405	A
44	L5	3407	G
44	L5	3414	G
44	L5	3415	U
44	L5	3416	A
44	L5	3418	C
44	L5	3421	U
44	L5	3422	G
44	L5	3434	G
44	L5	3441	A
44	L5	3442	A
44	L5	3443	U
44	L5	3446	C
44	L5	3449	G
44	L5	3459	U
44	L5	3467	C
44	L5	3468	G
44	L5	3469	C
44	L5	3470	A
44	L5	3471	U

*Continued on next page...*

*Continued from previous page...*

<b>Mol</b>	<b>Chain</b>	<b>Res</b>	<b>Type</b>
44	L5	3474	A
44	L5	3475	U
44	L5	3476	G
44	L5	3495	U
44	L5	3496	G
44	L5	3497	U
44	L5	3524	A
44	L5	3525	G
44	L5	3534	A
44	L5	3535	C
44	L5	3536	G
44	L5	3537	G
44	L5	3544	C
44	L5	3546	G
44	L5	3549	U
44	L5	3554	G
44	L5	3558	A
44	L5	3563	A
44	L5	3564	G
44	L5	3565	A
44	L5	3572	U
44	L5	3587	U
44	L5	3595	G
44	L5	3603	G
44	L5	3604	A
44	L5	3605	C
44	L5	3607	U
44	L5	3608	G
44	L5	3711	U
44	L5	3713	A
44	L5	3716	G
44	L5	3717	U
44	L5	3718	U
44	L5	3727	G
44	L5	3735	G
44	L5	3737	G
44	L5	3742	G
44	L5	3745	G
44	L5	3746	G
44	L5	3747	C
44	L5	3748	G
44	L5	3750	G

*Continued on next page...*

*Continued from previous page...*

<b>Mol</b>	<b>Chain</b>	<b>Res</b>	<b>Type</b>
44	L5	3752	C
44	L5	3754	C
44	L5	3755	G
44	L5	3756	A
44	L5	3757	G
44	L5	3758	G
44	L5	3759	G
44	L5	3760	G
44	L5	3762	U
44	L5	3765	C
44	L5	3766	G
44	L5	3767	C
44	L5	3770	C
44	L5	3773	G
44	L5	3778	A
44	L5	3783	U
44	L5	3785	C
44	L5	3786	G
44	L5	3787	U
44	L5	3799	G
44	L5	3803	G
44	L5	3815	C
44	L5	3816	U
44	L5	3823	A
44	L5	3830	C
44	L5	3836	G
44	L5	3844	G
44	L5	3846	C
44	L5	3849	G
44	L5	3856	A
44	L5	3867	A
44	L5	3875	G
44	L5	3878	G
44	L5	3881	G
44	L5	3882	U
44	L5	3885	U
44	L5	3886	A
44	L5	3895	U
44	L5	3904	A
44	L5	3907	G
44	L5	3910	A
44	L5	3918	U

*Continued on next page...*

*Continued from previous page...*

<b>Mol</b>	<b>Chain</b>	<b>Res</b>	<b>Type</b>
44	L5	3921	A
44	L5	3926	A
44	L5	3934	A
44	L5	3942	U
44	L5	3944	G
44	L5	3948	U
44	L5	3956	C
44	L5	3957	A
44	L5	3958	G
44	L5	3967	C
44	L5	3970	A
44	L5	3972	C
44	L5	3977	A
44	L5	3982	G
44	L5	3983	G
44	L5	3985	C
44	L5	3991	G
44	L5	3992	A
44	L5	4002	C
44	L5	4007	U
44	L5	4024	G
44	L5	4026	G
44	L5	4029	A
44	L5	4030	G
44	L5	4031	A
44	L5	4032	A
44	L5	4033	A
44	L5	4039	C
44	L5	4040	C
44	L5	4044	G
44	L5	4047	A
44	L5	4054	G
44	L5	4073	U
44	L5	4074	C
44	L5	4075	A
44	L5	4080	G
44	L5	4089	U
44	L5	4091	U
44	L5	4096	C
44	L5	4097	C
44	L5	4101	G
44	L5	4102	A

*Continued on next page...*

*Continued from previous page...*

<b>Mol</b>	<b>Chain</b>	<b>Res</b>	<b>Type</b>
44	L5	4105	U
44	L5	4117	A
44	L5	4128	G
44	L5	4152	G
44	L5	4163	A
44	L5	4165	U
44	L5	4166	A
44	L5	4168	G
44	L5	4171	A
44	L5	4172	C
44	L5	4177	G
44	L5	4185	U
44	L5	4198	G
44	L5	4201	A
44	L5	4202	G
44	L5	4207	G
44	L5	4208	U
44	L5	4213	C
44	L5	4220	G
44	L5	4223	G
44	L5	4225	U
44	L5	4228	G
44	L5	4237	A
44	L5	4238	U
44	L5	4241	U
44	L5	4242	A
44	L5	4243	A
44	L5	4253	G
44	L5	4261	G
44	L5	4270	G
44	L5	4279	A
44	L5	4286	G
44	L5	4289	U
44	L5	4290	G
44	L5	4292	G
44	L5	4300	G
44	L5	4305	G
44	L5	4309	A
44	L5	4310	U
44	L5	4323	C
44	L5	4325	A
44	L5	4332	G

*Continued on next page...*



*Continued from previous page...*

<b>Mol</b>	<b>Chain</b>	<b>Res</b>	<b>Type</b>
44	L5	4348	C
44	L5	4353	A
44	L5	4361	A
44	L5	4362	U
44	L5	4372	G
44	L5	4374	G
44	L5	4383	C
44	L5	4387	A
44	L5	4393	G
44	L5	4394	A
44	L5	4395	A
44	L5	4396	G
44	L5	4397	G
44	L5	4398	A
44	L5	4399	G
44	L5	4404	G
44	L5	4405	G
44	L5	4408	G
44	L5	4411	C
44	L5	4413	C
44	L5	4415	G
44	L5	4418	A
44	L5	4419	G
44	L5	4424	G
44	L5	4425	U
44	L5	4427	C
44	L5	4429	C
44	L5	4430	G
44	L5	4505	C
44	L5	4506	G
44	L5	4507	G
44	L5	4508	G
44	L5	4516	G
44	L5	4517	C
44	L5	4519	G
44	L5	4522	A
44	L5	4528	U
44	L5	4529	C
44	L5	4534	U
44	L5	4535	G
44	L5	4541	C
44	L5	4546	U

*Continued on next page...*

*Continued from previous page...*

<b>Mol</b>	<b>Chain</b>	<b>Res</b>	<b>Type</b>
44	L5	4547	G
44	L5	4548	C
44	L5	4549	G
44	L5	4553	G
44	L5	4554	G
44	L5	4555	A
44	L5	4558	G
44	L5	4559	G
44	L5	4560	C
44	L5	4561	G
44	L5	4562	G
44	L5	4564	C
44	L5	4565	G
44	L5	4583	U
44	L5	4584	U
44	L5	4585	G
44	L5	4586	A
44	L5	4588	C
44	L5	4589	G
44	L5	4591	A
44	L5	4592	C
44	L5	4597	G
44	L5	4598	U
44	L5	4599	G
44	L5	4604	A
44	L5	4608	G
44	L5	4610	C
44	L5	4611	G
44	L5	4612	C
44	L5	4624	U
44	L5	4633	U
44	L5	4636	U
44	L5	4639	U
44	L5	4640	G
44	L5	4662	A
44	L5	4665	G
44	L5	4670	U
44	L5	4671	C
44	L5	4672	C
44	L5	4673	C
44	L5	4674	U
44	L5	4675	C

*Continued on next page...*

*Continued from previous page...*

<b>Mol</b>	<b>Chain</b>	<b>Res</b>	<b>Type</b>
44	L5	4676	G
44	L5	4677	C
44	L5	4678	U
44	L5	4682	A
44	L5	4689	G
44	L5	4695	C
44	L5	4698	C
44	L5	4702	C
44	L5	4703	G
44	L5	4709	A
44	L5	4710	G
44	L5	4717	U
45	L7	7	G
45	L7	22	A
45	L7	23	A
45	L7	24	C
45	L7	25	G
45	L7	33	U
45	L7	38	U
45	L7	43	U
45	L7	53	U
45	L7	54	A
45	L7	64	G
45	L7	74	A
45	L7	93	G
45	L7	96	U
45	L7	100	A
45	L7	110	G
45	L7	112	U
45	L7	120	U
46	L8	2	G
46	L8	3	A
46	L8	18	U
46	L8	25	G
46	L8	34	U
46	L8	35	C
46	L8	38	U
46	L8	48	A
46	L8	59	A
46	L8	60	G
46	L8	62	A
46	L8	63	U

*Continued on next page...*

*Continued from previous page...*

<b>Mol</b>	<b>Chain</b>	<b>Res</b>	<b>Type</b>
46	L8	82	A
46	L8	83	C
46	L8	84	A
46	L8	85	U
46	L8	86	U
46	L8	87	G
46	L8	99	U
46	L8	103	A
46	L8	105	C
46	L8	109	C
46	L8	110	U
46	L8	111	U
46	L8	114	G
46	L8	124	U
46	L8	125	C
46	L8	126	C
46	L8	127	U
46	L8	147	G
46	L8	153	C
46	L8	156	U
47	S2	2	A
47	S2	3	C
47	S2	4	C
47	S2	17	C
47	S2	25	A
47	S2	33	G
47	S2	41	G
47	S2	44	U
47	S2	45	A
47	S2	46	A
47	S2	49	C
47	S2	56	G
47	S2	58	C
47	S2	59	U
47	S2	67	C
47	S2	68	A
47	S2	69	C
47	S2	71	G
47	S2	73	C
47	S2	74	G
47	S2	76	U
47	S2	79	A

*Continued on next page...*

*Continued from previous page...*

<b>Mol</b>	<b>Chain</b>	<b>Res</b>	<b>Type</b>
47	S2	92	A
47	S2	102	A
47	S2	103	A
47	S2	113	G
47	S2	114	G
47	S2	115	U
47	S2	126	G
47	S2	129	C
47	S2	143	U
47	S2	149	A
47	S2	154	U
47	S2	158	A
47	S2	161	U
47	S2	162	C
47	S2	166	A
47	S2	169	U
47	S2	170	A
47	S2	173	A
47	S2	178	C
47	S2	181	A
47	S2	182	C
47	S2	289	G
47	S2	291	U
47	S2	292	G
47	S2	295	U
47	S2	311	C
47	S2	314	A
47	S2	319	A
47	S2	320	C
47	S2	324	C
47	S2	330	G
47	S2	333	G
47	S2	348	G
47	S2	352	G
47	S2	361	A
47	S2	363	C
47	S2	364	A
47	S2	365	A
47	S2	369	U
47	S2	370	C
47	S2	371	G
47	S2	382	C

*Continued on next page...*

*Continued from previous page...*

<b>Mol</b>	<b>Chain</b>	<b>Res</b>	<b>Type</b>
47	S2	386	G
47	S2	387	C
47	S2	393	A
47	S2	408	G
47	S2	409	A
47	S2	410	C
47	S2	418	C
47	S2	419	A
47	S2	427	A
47	S2	429	U
47	S2	448	A
47	S2	449	A
47	S2	450	A
47	S2	451	C
47	S2	453	G
47	S2	465	A
47	S2	466	A
47	S2	468	G
47	S2	472	G
47	S2	473	C
47	S2	474	A
47	S2	475	G
47	S2	483	G
47	S2	488	U
47	S2	490	A
47	S2	493	C
47	S2	494	A
47	S2	501	A
47	S2	502	C
47	S2	504	C
47	S2	517	A
47	S2	518	C
47	S2	526	A
47	S2	529	A
47	S2	532	A
47	S2	533	C
47	S2	537	A
47	S2	538	C
47	S2	539	U
47	S2	540	C
47	S2	541	U
47	S2	542	U

*Continued on next page...*

*Continued from previous page...*

<b>Mol</b>	<b>Chain</b>	<b>Res</b>	<b>Type</b>
47	S2	543	U
47	S2	544	C
47	S2	545	G
47	S2	547	G
47	S2	548	G
47	S2	553	G
47	S2	556	A
47	S2	557	U
47	S2	558	U
47	S2	559	G
47	S2	560	G
47	S2	562	A
47	S2	564	G
47	S2	565	A
47	S2	566	G
47	S2	567	U
47	S2	571	C
47	S2	574	U
47	S2	577	A
47	S2	584	A
47	S2	585	A
47	S2	587	G
47	S2	588	A
47	S2	589	G
47	S2	591	A
47	S2	592	U
47	S2	597	U
47	S2	598	G
47	S2	604	C
47	S2	605	A
47	S2	608	U
47	S2	609	C
47	S2	613	U
47	S2	614	G
47	S2	615	C
47	S2	618	G
47	S2	623	C
47	S2	629	A
47	S2	630	A
47	S2	633	C
47	S2	638	U
47	S2	639	C

*Continued on next page...*

*Continued from previous page...*

<b>Mol</b>	<b>Chain</b>	<b>Res</b>	<b>Type</b>
47	S2	644	A
47	S2	645	G
47	S2	656	A
47	S2	661	C
47	S2	669	A
47	S2	670	A
47	S2	672	A
47	S2	673	A
47	S2	674	G
47	S2	688	C
47	S2	689	U
47	S2	750	U
47	S2	751	C
47	S2	796	A
47	S2	799	G
47	S2	800	U
47	S2	812	A
47	S2	821	U
47	S2	822	G
47	S2	823	U
47	S2	831	A
47	S2	832	G
47	S2	834	C
47	S2	835	C
47	S2	836	C
47	S2	837	G
47	S2	838	A
47	S2	839	G
47	S2	840	C
47	S2	841	C
47	S2	842	G
47	S2	843	C
47	S2	844	C
47	S2	847	G
47	S2	848	A
47	S2	870	A
47	S2	871	A
47	S2	873	A
47	S2	874	G
47	S2	875	G
47	S2	878	C
47	S2	884	U

*Continued on next page...*



*Continued from previous page...*

<b>Mol</b>	<b>Chain</b>	<b>Res</b>	<b>Type</b>
47	S2	885	C
47	S2	890	U
47	S2	892	G
47	S2	895	G
47	S2	896	G
47	S2	897	U
47	S2	898	U
47	S2	899	U
47	S2	900	U
47	S2	901	C
47	S2	902	G
47	S2	905	A
47	S2	907	U
47	S2	914	A
47	S2	915	U
47	S2	918	U
47	S2	920	A
47	S2	921	A
47	S2	923	A
47	S2	934	G
47	S2	952	C
47	S2	964	A
47	S2	972	G
47	S2	973	A
47	S2	979	G
47	S2	989	C
47	S2	991	A
47	S2	993	A
47	S2	1000	G
47	S2	1002	A
47	S2	1008	C
47	S2	1018	U
47	S2	1019	U
47	S2	1024	A
47	S2	1028	A
47	S2	1031	A
47	S2	1034	G
47	S2	1035	A
47	S2	1045	G
47	S2	1046	U
47	S2	1048	C
47	S2	1061	A

*Continued on next page...*

*Continued from previous page...*

<b>Mol</b>	<b>Chain</b>	<b>Res</b>	<b>Type</b>
47	S2	1062	U
47	S2	1063	A
47	S2	1068	C
47	S2	1084	A
47	S2	1086	C
47	S2	1090	G
47	S2	1102	U
47	S2	1109	G
47	S2	1110	C
47	S2	1115	U
47	S2	1117	C
47	S2	1139	C
47	S2	1140	C
47	S2	1149	A
47	S2	1154	C
47	S2	1155	U
47	S2	1159	G
47	S2	1195	A
47	S2	1196	A
47	S2	1204	G
47	S2	1208	G
47	S2	1209	A
47	S2	1216	C
47	S2	1217	C
47	S2	1218	A
47	S2	1225	G
47	S2	1228	G
47	S2	1243	U
47	S2	1244	U
47	S2	1248	C
47	S2	1249	U
47	S2	1252	A
47	S2	1254	A
47	S2	1257	G
47	S2	1258	G
47	S2	1260	A
47	S2	1262	C
47	S2	1264	U
47	S2	1265	C
47	S2	1272	C
47	S2	1275	G
47	S2	1276	G

*Continued on next page...*

*Continued from previous page...*

<b>Mol</b>	<b>Chain</b>	<b>Res</b>	<b>Type</b>
47	S2	1284	C
47	S2	1286	G
47	S2	1287	G
47	S2	1291	G
47	S2	1295	G
47	S2	1300	A
47	S2	1301	U
47	S2	1303	G
47	S2	1304	C
47	S2	1309	U
47	S2	1314	A
47	S2	1315	U
47	S2	1316	U
47	S2	1318	C
47	S2	1319	G
47	S2	1321	G
47	S2	1327	U
47	S2	1333	A
47	S2	1343	U
47	S2	1344	U
47	S2	1346	G
47	S2	1349	G
47	S2	1359	U
47	S2	1372	U
47	S2	1373	U
47	S2	1379	A
47	S2	1397	A
47	S2	1402	A
47	S2	1403	A
47	S2	1407	G
47	S2	1409	U
47	S2	1415	A
47	S2	1416	C
47	S2	1419	C
47	S2	1421	G
47	S2	1422	A
47	S2	1423	G
47	S2	1424	C
47	S2	1430	G
47	S2	1441	C
47	S2	1449	A
47	S2	1450	G

*Continued on next page...*

*Continued from previous page...*

<b>Mol</b>	<b>Chain</b>	<b>Res</b>	<b>Type</b>
47	S2	1451	G
47	S2	1453	A
47	S2	1455	A
47	S2	1464	U
47	S2	1466	A
47	S2	1470	A
47	S2	1475	A
47	S2	1476	G
47	S2	1481	A
47	S2	1485	A
47	S2	1488	A
47	S2	1489	C
47	S2	1490	A
47	S2	1491	G
47	S2	1495	U
47	S2	1496	G
47	S2	1498	G
47	S2	1499	A
47	S2	1508	G
47	S2	1510	U
47	S2	1511	G
47	S2	1522	C
47	S2	1532	A
47	S2	1534	A
47	S2	1545	C
47	S2	1556	U
47	S2	1557	A
47	S2	1561	U
47	S2	1571	G
47	S2	1575	C
47	S2	1578	G
47	S2	1581	A
47	S2	1586	U
47	S2	1587	U
47	S2	1588	G
47	S2	1589	A
47	S2	1601	G
47	S2	1602	A
47	S2	1603	U
47	S2	1604	G
47	S2	1607	G
47	S2	1613	G

*Continued on next page...*

*Continued from previous page...*

<b>Mol</b>	<b>Chain</b>	<b>Res</b>	<b>Type</b>
47	S2	1615	A
47	S2	1622	U
47	S2	1624	A
47	S2	1628	C
47	S2	1635	A
47	S2	1639	G
47	S2	1644	U
47	S2	1647	C
47	S2	1649	G
47	S2	1655	G
47	S2	1662	A
47	S2	1664	A
47	S2	1666	G
47	S2	1672	G
47	S2	1680	A
47	S2	1681	G
47	S2	1685	C
47	S2	1687	G
47	S2	1699	C
47	S2	1706	C
47	S2	1722	U
47	S2	1723	G
47	S2	1728	G
47	S2	1729	U
47	S2	1744	G
47	S2	1745	G
47	S2	1746	A
47	S2	1749	G
47	S2	1753	C
47	S2	1754	C
47	S2	1756	C
47	S2	1759	G
47	S2	1760	G
47	S2	1761	G
47	S2	1762	U
47	S2	1772	G
47	S2	1774	C
47	S2	1775	C
47	S2	1776	U
47	S2	1777	G
47	S2	1778	G
47	S2	1780	G

*Continued on next page...*

*Continued from previous page...*

<b>Mol</b>	<b>Chain</b>	<b>Res</b>	<b>Type</b>
47	S2	1783	G
47	S2	1784	C
47	S2	1785	G
47	S2	1787	U
47	S2	1799	C
47	S2	1808	C
47	S2	1818	G
47	S2	1819	A
47	S2	1821	G
47	S2	1823	A
47	S2	1824	A
47	S2	1825	A
47	S2	1827	G
47	S2	1830	G
47	S2	1836	A
47	S2	1838	G
47	S2	1839	U
47	S2	1850	G
47	S2	1852	A
47	S2	1853	C
47	S2	1862	G
47	S2	1863	G
47	S2	1864	A
47	S2	1865	U
47	S2	1866	C
77	S6	3	G
77	S6	4	C
77	S6	9	U
77	S6	10	G
77	S6	11	G
77	S6	17	C
77	S6	18	G
77	S6	19	G
77	S6	20	A
77	S6	21	A
77	S6	22	G
77	S6	23	C
77	S6	24	G
77	S6	45	G
77	S6	46	G
77	S6	47	U
77	S6	48	C

*Continued on next page...*

*Continued from previous page...*

<b>Mol</b>	<b>Chain</b>	<b>Res</b>	<b>Type</b>
77	S6	49	G
77	S6	52	G
77	S6	53	G
77	S6	54	A
77	S6	55	U
77	S6	56	C
77	S6	57	G
77	S6	58	A
77	S6	59	A
77	S6	60	A
77	S6	67	U
77	S6	69	U
77	S6	72	U
77	S6	74	C
77	S6	76	A

All (32) RNA pucker outliers are listed below:

<b>Mol</b>	<b>Chain</b>	<b>Res</b>	<b>Type</b>
44	L5	236	G
44	L5	265	C
44	L5	492	G
44	L5	652	G
44	L5	676	C
44	L5	1388	G
44	L5	1447	G
44	L5	1776	G
44	L5	1836	A
44	L5	2429	G
44	L5	2514	G
44	L5	2540	C
44	L5	3271	G
44	L5	3369	A
44	L5	3417	A
44	L5	4352	U
44	L5	4560	C
44	L5	4597	G
44	L5	4673	C
47	S2	112	U
47	S2	531	U
47	S2	532	A
47	S2	608	U

*Continued on next page...*

*Continued from previous page...*

Mol	Chain	Res	Type
47	S2	629	A
47	S2	972	G
47	S2	1521	G
47	S2	1721	U
47	S2	1782	A
77	S6	19	G
77	S6	53	G
77	S6	54	A
77	S6	56	C

#### 5.4 Non-standard residues in protein, DNA, RNA chains [i](#)

There are no non-standard protein/DNA/RNA residues in this entry.

#### 5.5 Carbohydrates [i](#)

There are no monosaccharides in this entry.

#### 5.6 Ligand geometry [i](#)

Of 278 ligands modelled in this entry, 278 are monoatomic - leaving 0 for Mogul analysis.

There are no bond length outliers.

There are no bond angle outliers.

There are no chirality outliers.

There are no torsion outliers.

There are no ring outliers.

No monomer is involved in short contacts.

#### 5.7 Other polymers [i](#)

There are no such residues in this entry.

#### 5.8 Polymer linkage issues [i](#)

There are no chain breaks in this entry.



## 6 Map visualisation [i](#)

This section contains visualisations of the EMDB entry EMD-30432. These allow visual inspection of the internal detail of the map and identification of artifacts.

No raw map or half-maps were deposited for this entry and therefore no images, graphs, etc. pertaining to the raw map can be shown.

### 6.1 Orthogonal projections [i](#)

#### 6.1.1 Primary map

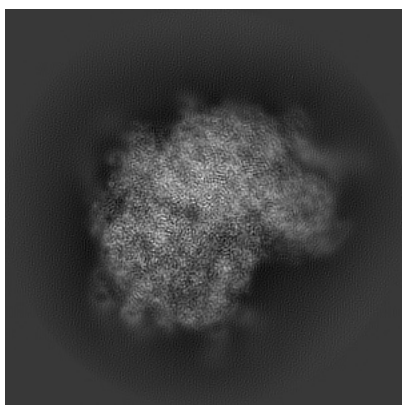

X

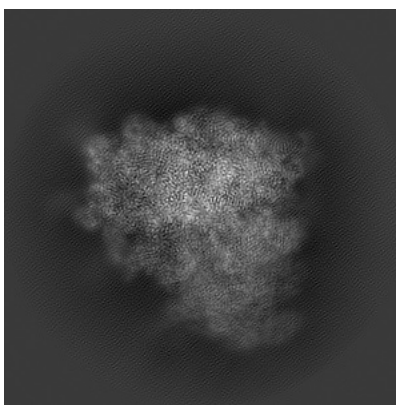

Y

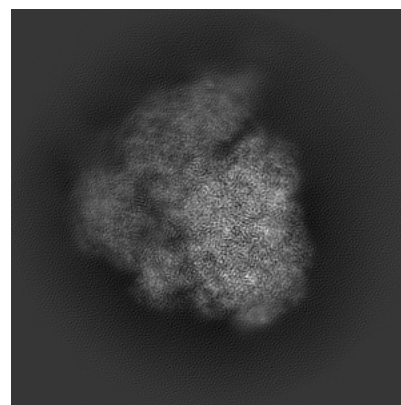

Z

The images above show the map projected in three orthogonal directions.

### 6.2 Central slices [i](#)

#### 6.2.1 Primary map

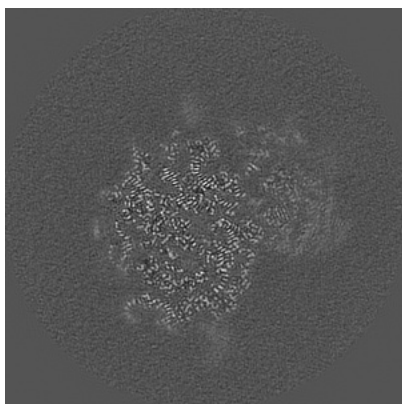

X Index: 200

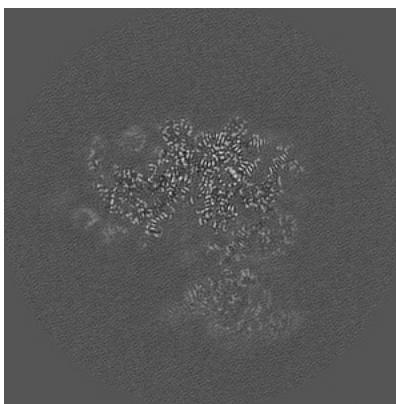

Y Index: 200

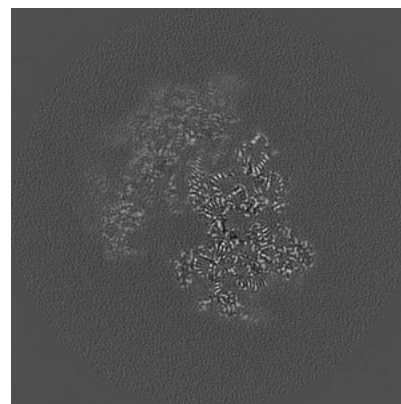

Z Index: 200

The images above show central slices of the map in three orthogonal directions.

## 6.3 Largest variance slices [i](#)

### 6.3.1 Primary map

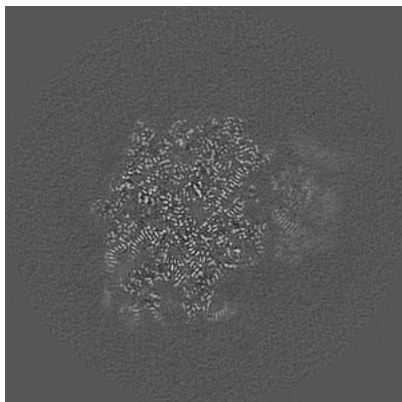

X Index: 219

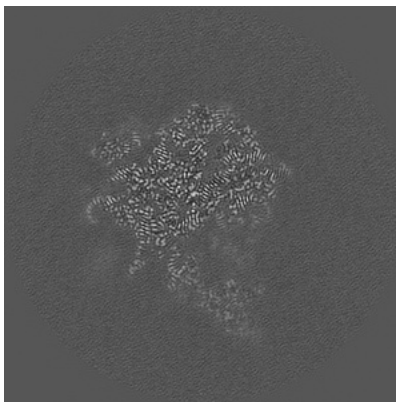

Y Index: 159

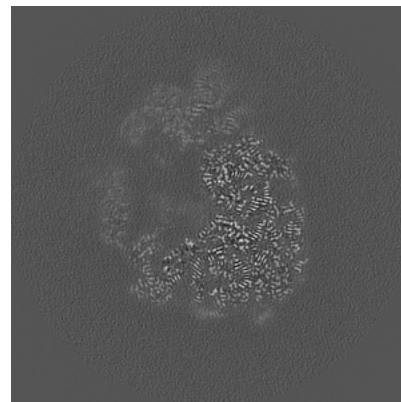

Z Index: 181

The images above show the largest variance slices of the map in three orthogonal directions.

## 6.4 Orthogonal surface views [i](#)

### 6.4.1 Primary map

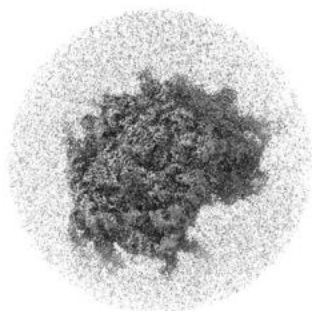

X

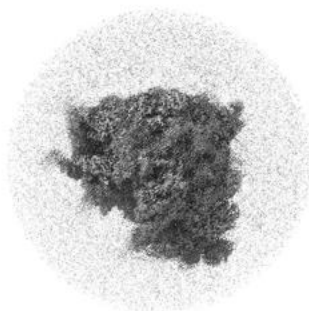

Y

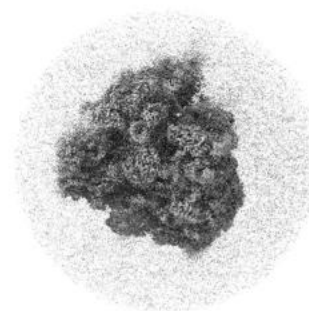

Z

The images above show the 3D surface view of the map at the recommended contour level 0.026. These images, in conjunction with the slice images, may facilitate assessment of whether an appropriate contour level has been provided.

## 6.5 Mask visualisation

This section was not generated. No masks/segmentation were deposited.

## 7 Map analysis [i](#)

This section contains the results of statistical analysis of the map.

### 7.1 Map-value distribution [i](#)

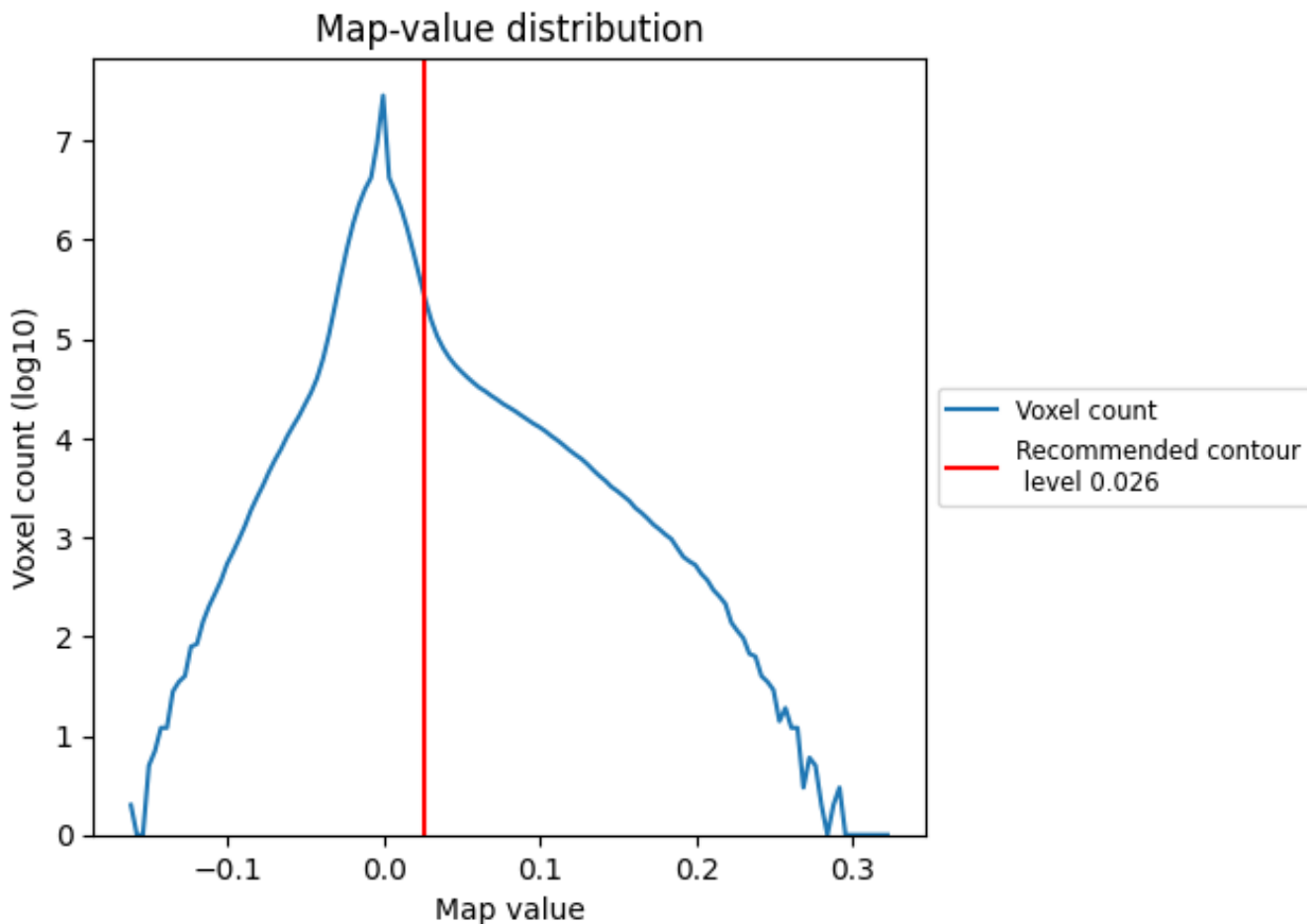

The map-value distribution is plotted in 128 intervals along the x-axis. The y-axis is logarithmic. A spike in this graph at zero usually indicates that the volume has been masked.

## 7.2 Volume estimate [i](#)

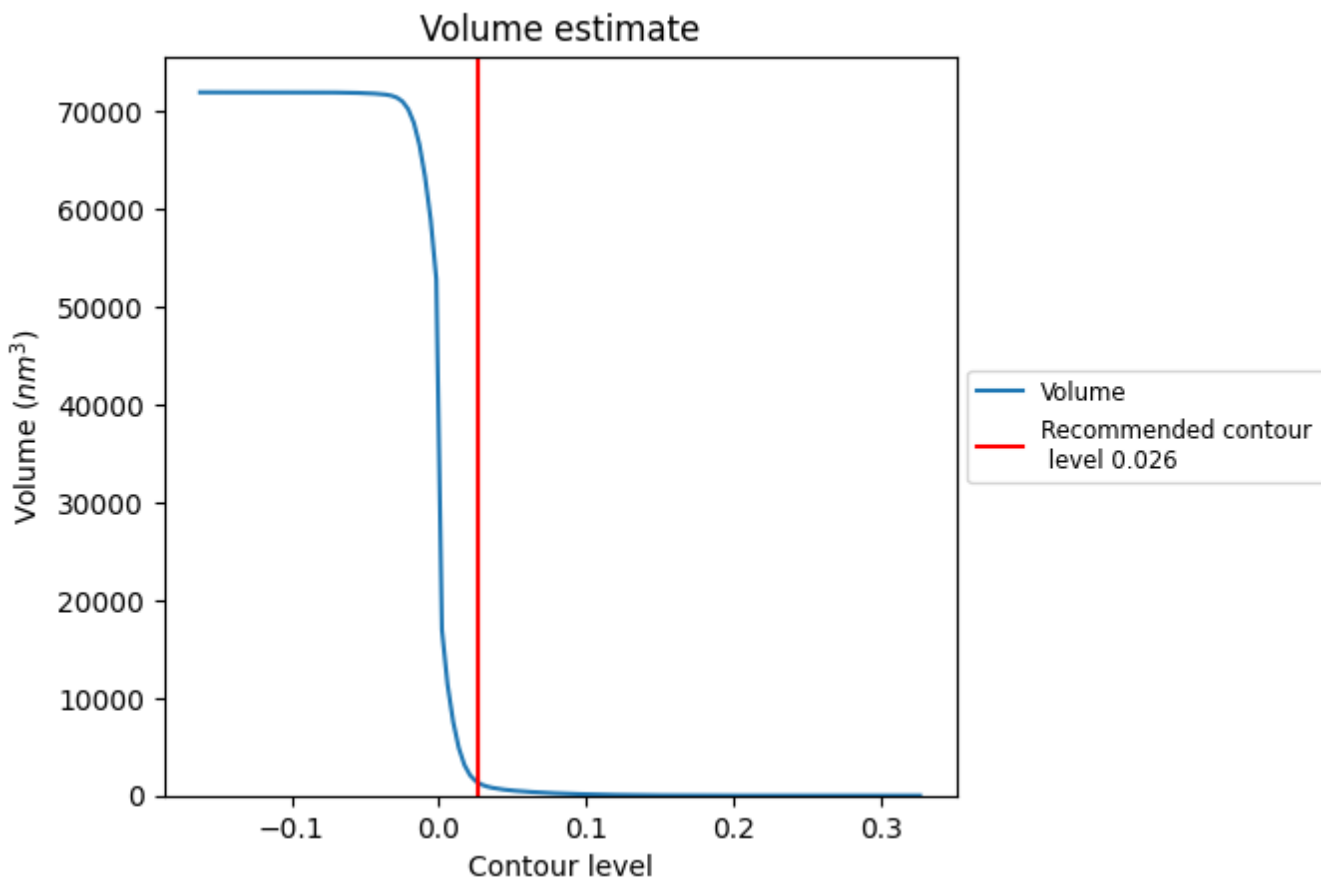

The volume at the recommended contour level is 1382 nm<sup>3</sup>; this corresponds to an approximate mass of 1248 kDa.

The volume estimate graph shows how the enclosed volume varies with the contour level. The recommended contour level is shown as a vertical line and the intersection between the line and the curve gives the volume of the enclosed surface at the given level.

### 7.3 Rotationally averaged power spectrum [\(i\)](#)

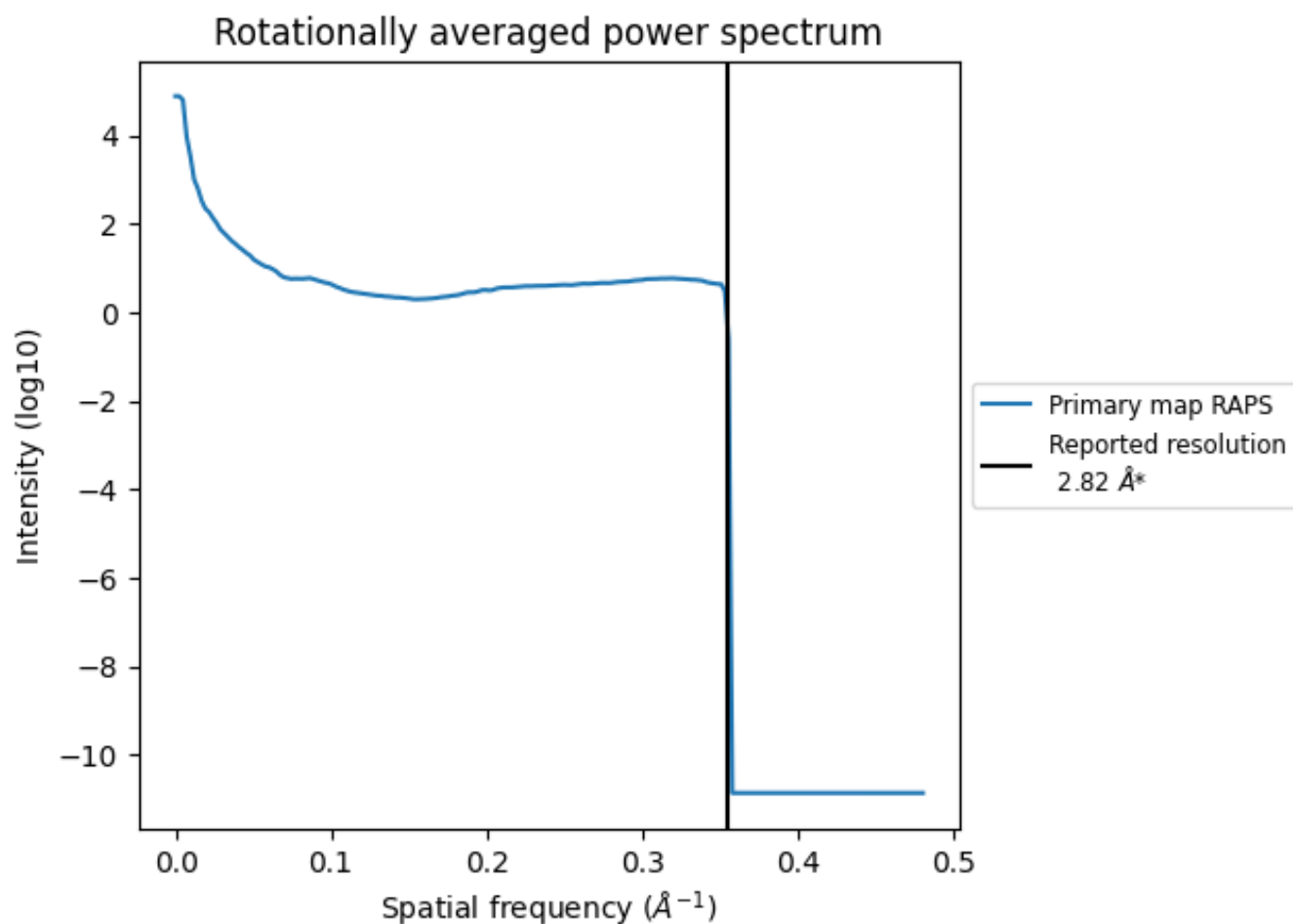

\*Reported resolution corresponds to spatial frequency of 0.355 Å<sup>-1</sup>

## 8 Fourier-Shell correlation

This section was not generated. No FSC curve or half-maps provided.

## 9 Map-model fit [i](#)

This section contains information regarding the fit between EMDB map EMD-30432 and PDB model 7CPU. Per-residue inclusion information can be found in section 3 on page 19.

### 9.1 Map-model overlay [i](#)

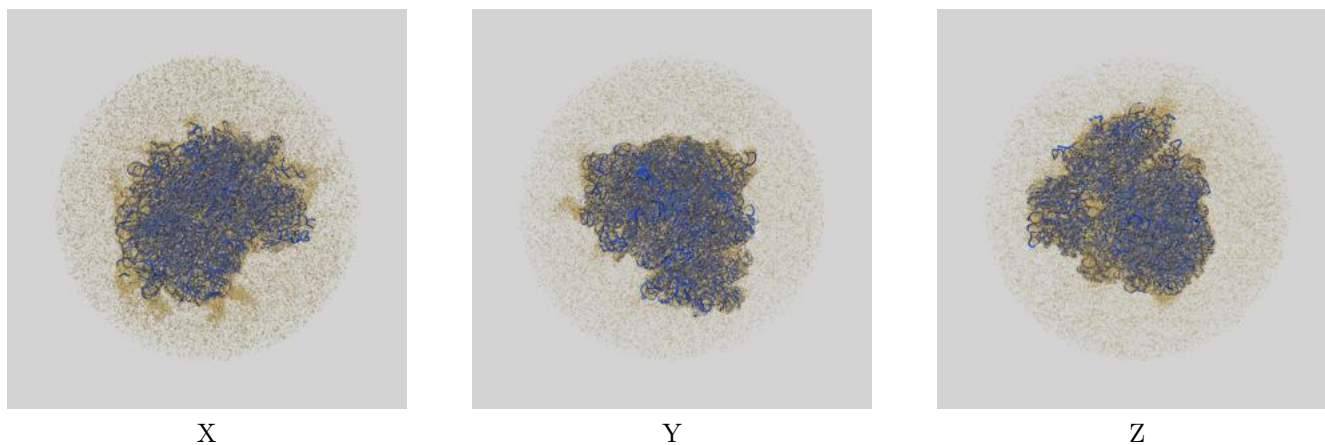

The images above show the 3D surface view of the map at the recommended contour level 0.026 at 50% transparency in yellow overlaid with a ribbon representation of the model coloured in blue. These images allow for the visual assessment of the quality of fit between the atomic model and the map.



## 9.2 Q-score mapped to coordinate model [\(i\)](#)

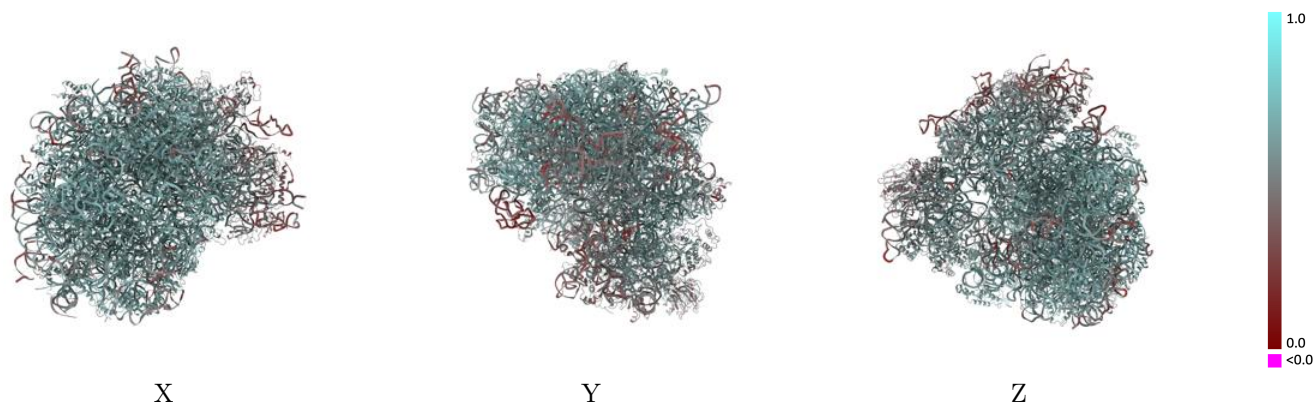

The images above show the model with each residue coloured according to its Q-score. This shows their resolvability in the map with higher Q-score values reflecting better resolvability. Please note: Q-score is calculating the resolvability of atoms, and thus high values are only expected at resolutions at which atoms can be resolved. Low Q-score values may therefore be expected for many entries.

## 9.3 Atom inclusion mapped to coordinate model [\(i\)](#)

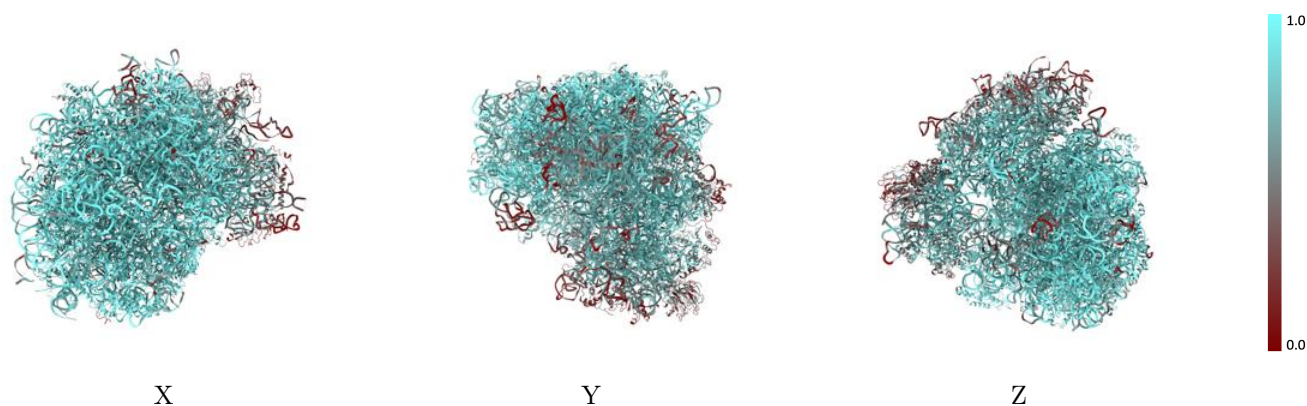

The images above show the model with each residue coloured according to its atom inclusion. This shows to what extent they are inside the map at the recommended contour level (0.026).



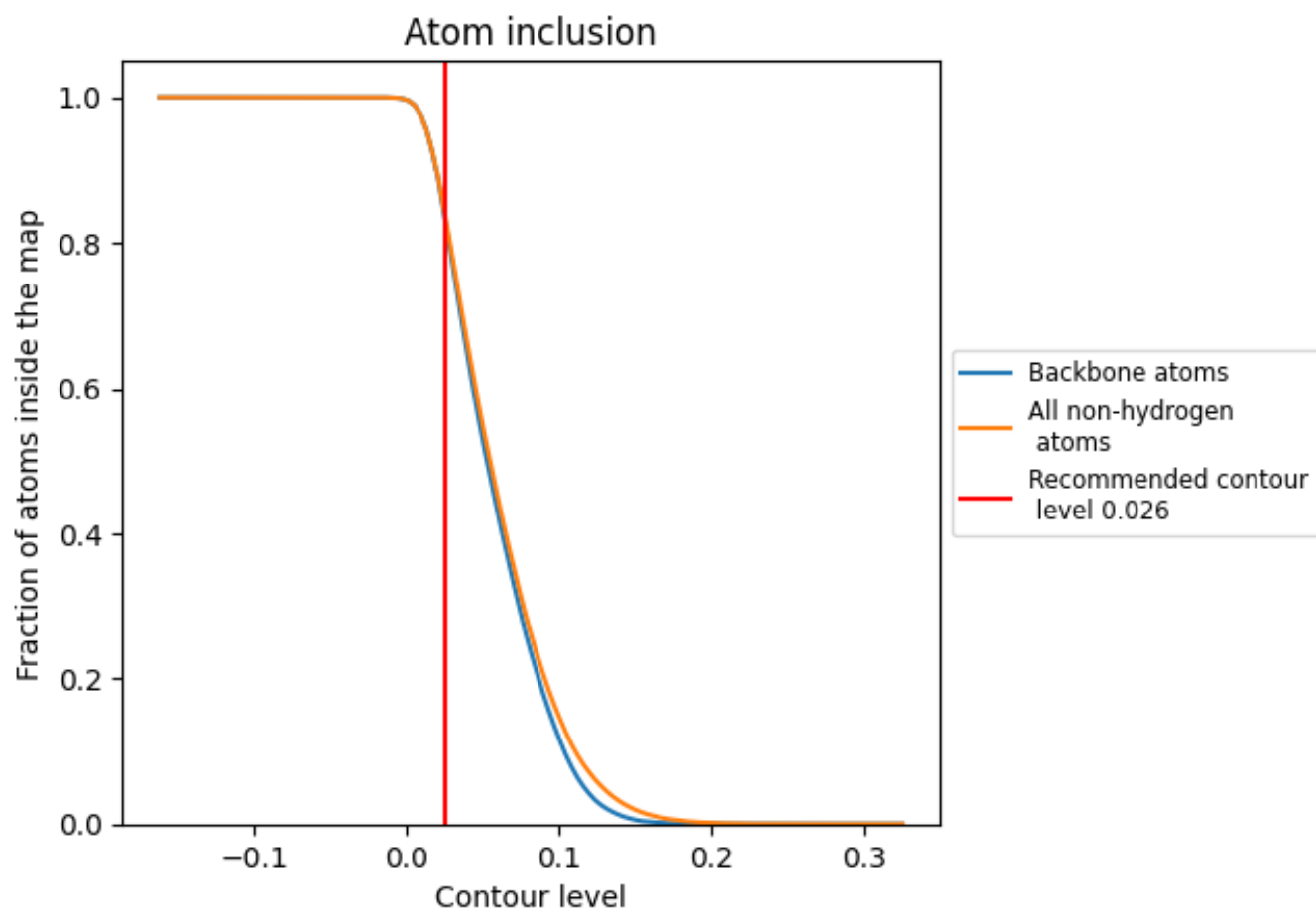



































































## 9.4 Atom inclusion [i](#)



At the recommended contour level, 83% of all backbone atoms, 83% of all non-hydrogen atoms, are inside the map.

## 9.5 Map-model fit summary





















































































The table lists the average atom inclusion at the recommended contour level (0.026) and Q-score for the entire model and for each chain.

Chain	Atom inclusion	Q-score
All	 0.8337	 0.5800
L5	 0.9054	 0.5950
L7	 0.9805	 0.6350
L8	 0.9241	 0.6160
LA	 0.9411	 0.6470
LB	 0.9261	 0.6370
LC	 0.9170	 0.6310
LD	 0.9018	 0.6180
LE	 0.8351	 0.5930
LF	 0.9463	 0.6470
LG	 0.8502	 0.6060
LH	 0.9082	 0.6220
LI	 0.9242	 0.6350
LJ	 0.8414	 0.5920
LL	 0.8976	 0.6180
LM	 0.9374	 0.6330
LN	 0.9692	 0.6540
LO	 0.9370	 0.6420
LP	 0.9243	 0.6410
LQ	 0.9414	 0.6510
LR	 0.8491	 0.6110
LS	 0.9500	 0.6510
LT	 0.9034	 0.6240
LU	 0.8010	 0.5750
LV	 0.9223	 0.6380
LW	 0.9220	 0.6360
LX	 0.9021	 0.6350
LY	 0.9061	 0.6300
LZ	 0.8816	 0.6120
La	 0.9575	 0.6520
Lb	 0.8683	 0.6130
Lc	 0.8895	 0.6130
Ld	 0.8775	 0.6240
Le	 0.9450	 0.6480
Lf	 0.9597	 0.6560



*Continued on next page...*

*Continued from previous page...*

Chain	Atom inclusion	Q-score
Lg	 0.9200	 0.6350
Lh	 0.8930	 0.6290
Li	 0.8684	 0.6110
Lj	 0.9554	 0.6430
Lk	 0.7914	 0.6040
Ll	 0.9314	 0.6430
Lm	 0.9286	 0.6360
Ln	 0.8165	 0.6030
Lo	 0.9009	 0.6360
Lp	 0.8940	 0.6370
Lr	 0.9361	 0.6330
S2	 0.7821	 0.5320
S6	 0.5954	 0.4350
SA	 0.6803	 0.5450
SB	 0.7616	 0.5770
SC	 0.7795	 0.5800
SD	 0.4545	 0.4910
SE	 0.5973	 0.4910
SF	 0.6647	 0.5500
SG	 0.4534	 0.4760
SH	 0.4944	 0.4990
SI	 0.6349	 0.5060
SJ	 0.5544	 0.4460
SK	 0.3162	 0.4500
SL	 0.7614	 0.5690
SN	 0.7534	 0.5840
SO	 0.7903	 0.5810
SP	 0.7024	 0.5480
SQ	 0.6524	 0.5310
SR	 0.5193	 0.5050
SS	 0.6935	 0.5600
ST	 0.6975	 0.5500
SU	 0.4128	 0.4550
SV	 0.6818	 0.5480
SW	 0.8426	 0.6000
SX	 0.7498	 0.5810
SY	 0.4429	 0.4160
SZ	 0.5722	 0.5180
Sa	 0.8150	 0.5910
Sb	 0.6541	 0.5470
Sc	 0.6015	 0.5180
Sd	 0.7517	 0.5660

*Continued on next page...*

*Continued from previous page...*

Chain	Atom inclusion	Q-score
Se	 0.5176	 0.4890
Sg	 0.3745	 0.4500