



wwPDB X-ray Structure Validation Summary Report ⓘ

Mar 3, 2024 – 09:15 AM EST

PDB ID : 6BR1
Title : Tubulin-RB3_SLD-TTL in complex with heterocyclic pyrimidine compound 4a
Authors : Kumar, G.; Wang, Y.; Li, W.; White, S.W.
Deposited on : 2017-11-29
Resolution : 2.30 Å(reported)

This is a wwPDB X-ray Structure Validation Summary Report for a publicly released PDB entry.

We welcome your comments at validation@mail.wwpdb.org

A user guide is available at

<https://www.wwpdb.org/validation/2017/XrayValidationReportHelp>

with specific help available everywhere you see the ⓘ symbol.

The types of validation reports are described at

<http://www.wwpdb.org/validation/2017/FAQs#types>.

The following versions of software and data (see [references ⓘ](#)) were used in the production of this report:

MolProbity : 4.02b-467
Mogul : 1.8.5 (274361), CSD as541be (2020)
Xtriage (Phenix) : 1.13
EDS : 2.36
buster-report : 1.1.7 (2018)
Percentile statistics : 20191225.v01 (using entries in the PDB archive December 25th 2019)
Refmac : 5.8.0158
CCP4 : 7.0.044 (Gargrove)
Ideal geometry (proteins) : Engh & Huber (2001)
Ideal geometry (DNA, RNA) : Parkinson et al. (1996)
Validation Pipeline (wwPDB-VP) : 2.36

1 Overall quality at a glance

The following experimental techniques were used to determine the structure:

X-RAY DIFFRACTION

The reported resolution of this entry is 2.30 Å.

Percentile scores (ranging between 0-100) for global validation metrics of the entry are shown in the following graphic. The table shows the number of entries on which the scores are based.

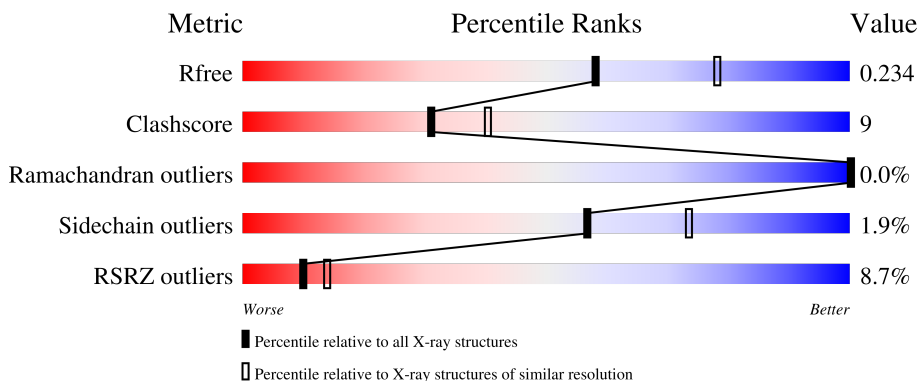

Metric	Whole archive (#Entries)	Similar resolution (#Entries, resolution range(Å))
R_{free}	130704	5042 (2.30-2.30)
Clashscore	141614	5643 (2.30-2.30)
Ramachandran outliers	138981	5575 (2.30-2.30)
Sidechain outliers	138945	5575 (2.30-2.30)
RSRZ outliers	127900	4938 (2.30-2.30)

The table below summarises the geometric issues observed across the polymeric chains and their fit to the electron density. The red, orange, yellow and green segments of the lower bar indicate the fraction of residues that contain outliers for ≥ 3 , 2, 1 and 0 types of geometric quality criteria respectively. A grey segment represents the fraction of residues that are not modelled. The numeric value for each fraction is indicated below the corresponding segment, with a dot representing fractions $\leq 5\%$. The upper red bar (where present) indicates the fraction of residues that have poor fit to the electron density. The numeric value is given above the bar.

Mol	Chain	Length	Quality of chain
1	A	450	
1	C	450	
2	B	445	
2	D	445	
3	E	143	

Continued on next page...

Continued from previous page...

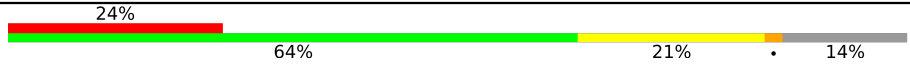
Mol	Chain	Length	Quality of chain
4	F	384	 <p>A horizontal bar chart representing the quality of chain. The bar is divided into four segments: a red segment (24%), a green segment (64%), a yellow segment (21%), and a grey segment (14%). The percentages are labeled above or below the corresponding segments.</p>

2 Entry composition [i](#)

There are 12 unique types of molecules in this entry. The entry contains 18174 atoms, of which 14 are hydrogens and 0 are deuteriums.

In the tables below, the ZeroOcc column contains the number of atoms modelled with zero occupancy, the AltConf column contains the number of residues with at least one atom in alternate conformation and the Trace column contains the number of residues modelled with at most 2 atoms.

- Molecule 1 is a protein called Tubulin alpha-1B chain.

Mol	Chain	Residues	Atoms					ZeroOcc	AltConf	Trace
			Total	C	N	O	S			
1	A	437	Total	C	N	O	S	0	0	0
			3416	2163	581	650	22			
1	C	440	Total	C	N	O	S	0	0	0
			3437	2175	584	656	22			

- Molecule 2 is a protein called Tubulin beta-2B chain.

Mol	Chain	Residues	Atoms					ZeroOcc	AltConf	Trace
			Total	C	N	O	S			
2	B	427	Total	C	N	O	S	0	0	0
			3361	2110	576	649	26			
2	D	421	Total	C	N	O	S	0	0	0
			3305	2078	562	639	26			

- Molecule 3 is a protein called Stathmin-4.

Mol	Chain	Residues	Atoms					ZeroOcc	AltConf	Trace
			Total	C	N	O	S			
3	E	121	Total	C	N	O	S	0	0	0
			1000	617	181	197	5			

There are 2 discrepancies between the modelled and reference sequences:

Chain	Residue	Modelled	Actual	Comment	Reference
E	3	MET	-	expression tag	UNP Q9H169
E	4	ALA	-	expression tag	UNP Q9H169

- Molecule 4 is a protein called Tubulin tyrosine ligase.

Mol	Chain	Residues	Atoms					ZeroOcc	AltConf	Trace
			Total	C	N	O	S			
4	F	332	Total	C	N	O	S	0	0	0
			2717	1743	467	493	14			

There are 6 discrepancies between the modelled and reference sequences:

Chain	Residue	Modelled	Actual	Comment	Reference
F	379	HIS	-	expression tag	UNP E1BQ43
F	380	HIS	-	expression tag	UNP E1BQ43
F	381	HIS	-	expression tag	UNP E1BQ43
F	382	HIS	-	expression tag	UNP E1BQ43
F	383	HIS	-	expression tag	UNP E1BQ43
F	384	HIS	-	expression tag	UNP E1BQ43

- Molecule 5 is GUANOSINE-5'-TRIPHOSPHATE (three-letter code: GTP) (formula: $C_{10}H_{16}N_5O_{14}P_3$).



Mol	Chain	Residues	Atoms					ZeroOcc	AltConf
			Total	C	N	O	P		
5	A	1	Total	C	N	O	P	0	0
			32	10	5	14	3		
5	C	1	Total	C	N	O	P	0	0
			32	10	5	14	3		

- Molecule 6 is CALCIUM ION (three-letter code: CA) (formula: Ca).

Mol	Chain	Residues	Atoms		ZeroOcc	AltConf
			Total	Ca		
6	A	1	Total	Ca	0	0
			1	1		
6	C	1	Total	Ca	0	0
			1	1		

- Molecule 7 is MAGNESIUM ION (three-letter code: MG) (formula: Mg).

Mol	Chain	Residues	Atoms	ZeroOcc	AltConf
7	A	1	Total Mg 1 1	0	0
7	B	1	Total Mg 1 1	0	0
7	C	1	Total Mg 1 1	0	0
7	F	1	Total Mg 1 1	0	0

- Molecule 8 is GUANOSINE-5'-DIPHOSPHATE (three-letter code: GDP) (formula: $C_{10}H_{15}N_5O_{11}P_2$).

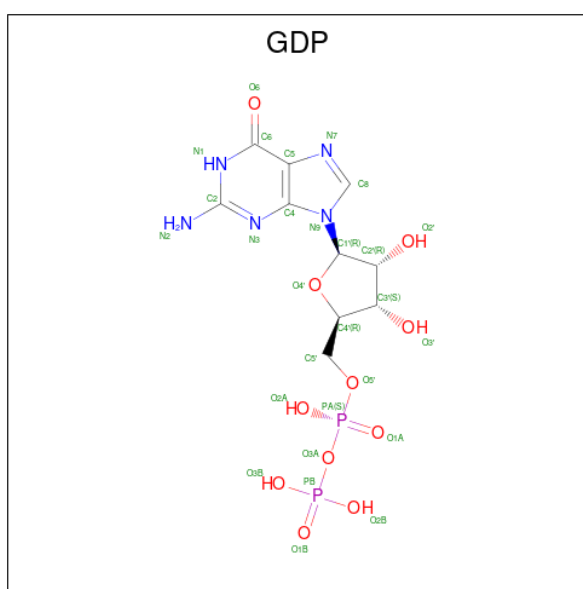

Mol	Chain	Residues	Atoms	ZeroOcc	AltConf
8	B	1	Total C N O P 28 10 5 11 2	0	0
8	D	1	Total C N O P 28 10 5 11 2	0	0

- Molecule 9 is 2-(N-MORPHOLINO)-ETHANESULFONIC ACID (three-letter code: MES) (formula: $C_6H_{13}NO_4S$).



Mol	Chain	Residues	Atoms					ZeroOcc	AltConf	
			Total	C	N	O	S			
9	B	1	Total	12	6	1	4	1	0	0
9	B	1	Total	12	6	1	4	1	0	0

- Molecule 10 is 2-chloro-4-(6-methoxy-3,4-dihydroquinolin-1(2H)-yl)pyrido[2,3-d]pyrimidine (three-letter code: E3Y) (formula: C₁₇H₁₅ClN₄O) (labeled as "Ligand of Interest" by depositor).

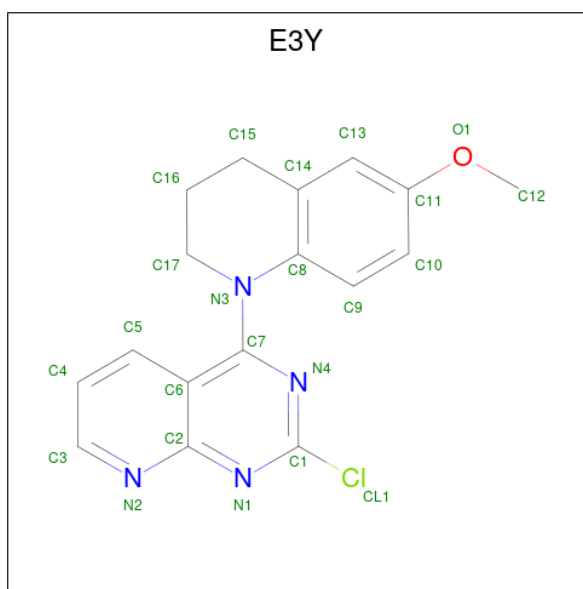

Mol	Chain	Residues	Atoms					ZeroOcc	AltConf	
			Total	C	Cl	N	O			
10	B	1	Total	23	17	1	4	1	0	0

Continued on next page...

Continued from previous page...

Mol	Chain	Residues	Atoms				ZeroOcc	AltConf	
			Total	C	Cl	N			O
10	D	1	23	17	1	4	1	0	0

- Molecule 11 is PHOSPHOMETHYLPHOSPHONIC ACID ADENYLATE ESTER (three-letter code: ACP) (formula: $C_{11}H_{18}N_5O_{12}P_3$).

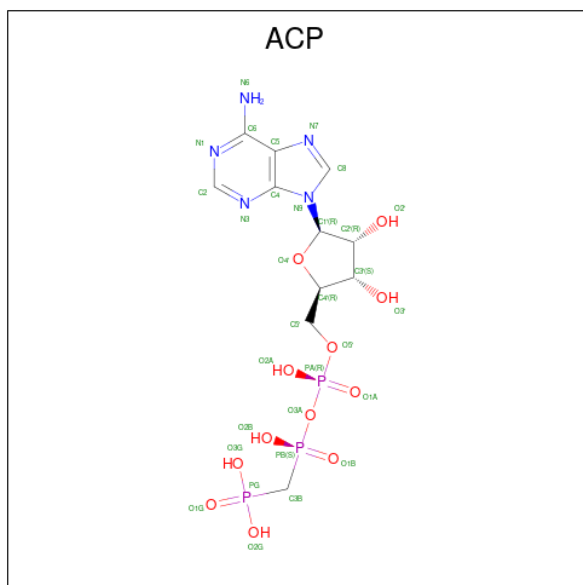

Mol	Chain	Residues	Atoms					ZeroOcc	AltConf	
			Total	C	H	N	O			P
11	F	1	45	11	14	5	12	3	0	0

- Molecule 12 is water.

Mol	Chain	Residues	Atoms		ZeroOcc	AltConf
12	A	165	Total	O	0	0
			165	165		
12	B	127	Total	O	0	0
			127	127		
12	C	251	Total	O	0	0
			251	251		
12	D	62	Total	O	0	0
			62	62		
12	E	30	Total	O	0	0
			30	30		
12	F	62	Total	O	0	0
			62	62		

3 Residue-property plots

These plots are drawn for all protein, RNA, DNA and oligosaccharide chains in the entry. The first graphic for a chain summarises the proportions of the various outlier classes displayed in the second graphic. The second graphic shows the sequence view annotated by issues in geometry and electron density. Residues are color-coded according to the number of geometric quality criteria for which they contain at least one outlier: green = 0, yellow = 1, orange = 2 and red = 3 or more. A red dot above a residue indicates a poor fit to the electron density ($RSRZ > 2$). Stretches of 2 or more consecutive residues without any outlier are shown as a green connector. Residues present in the sample, but not in the model, are shown in grey.

- Molecule 1: Tubulin alpha-1B chain

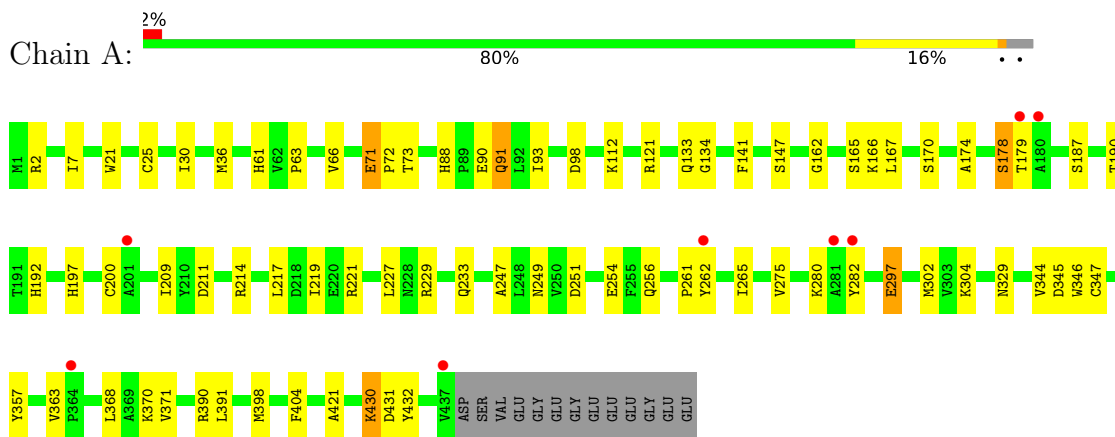

- Molecule 1: Tubulin alpha-1B chain

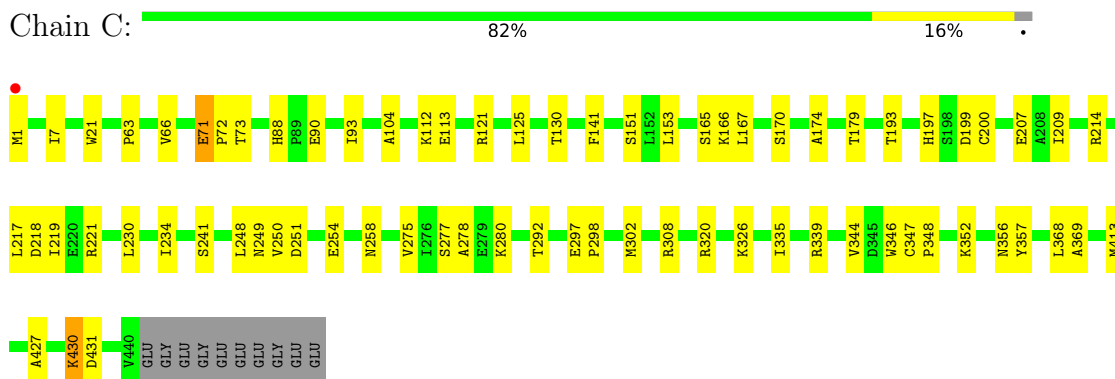

- Molecule 2: Tubulin beta-2B chain

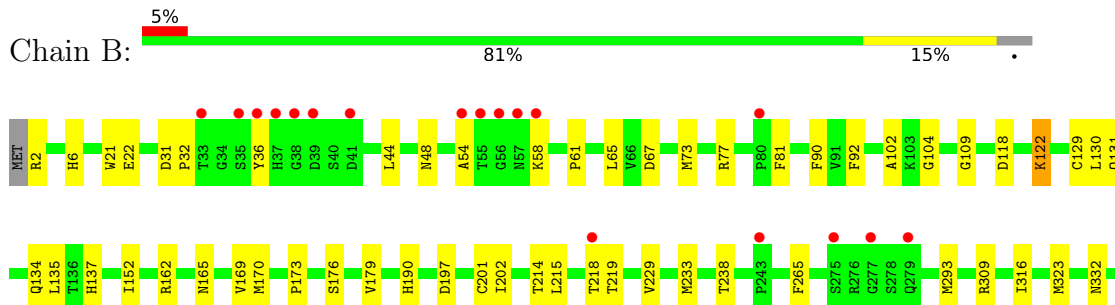

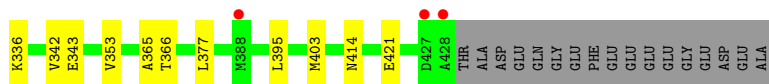

● Molecule 2: Tubulin beta-2B chain

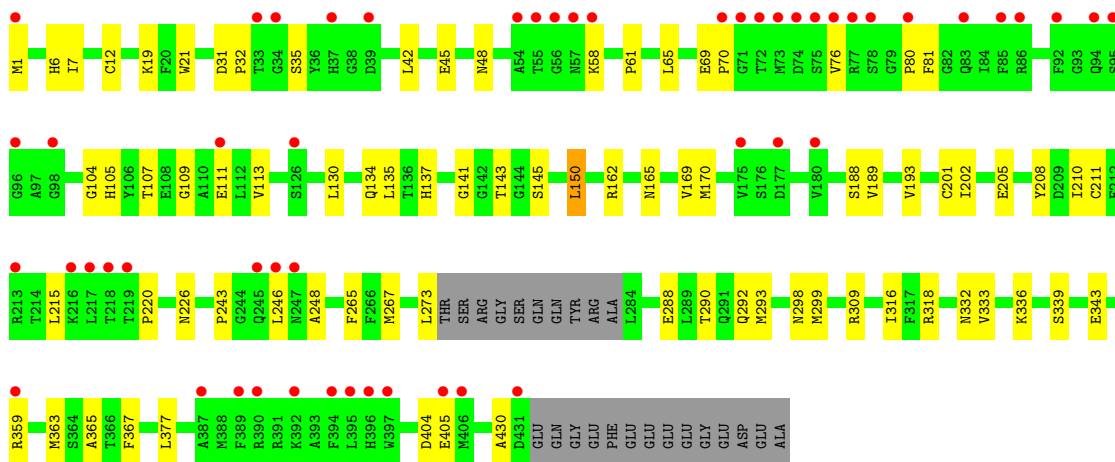
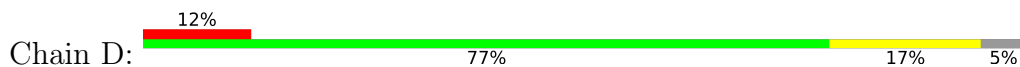

● Molecule 3: Stathmin-4

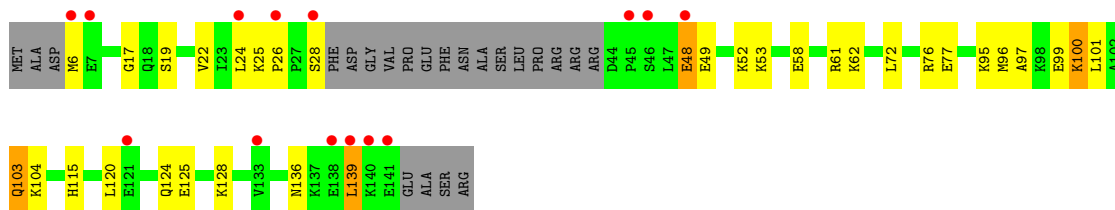

● Molecule 4: Tubulin tyrosine ligase

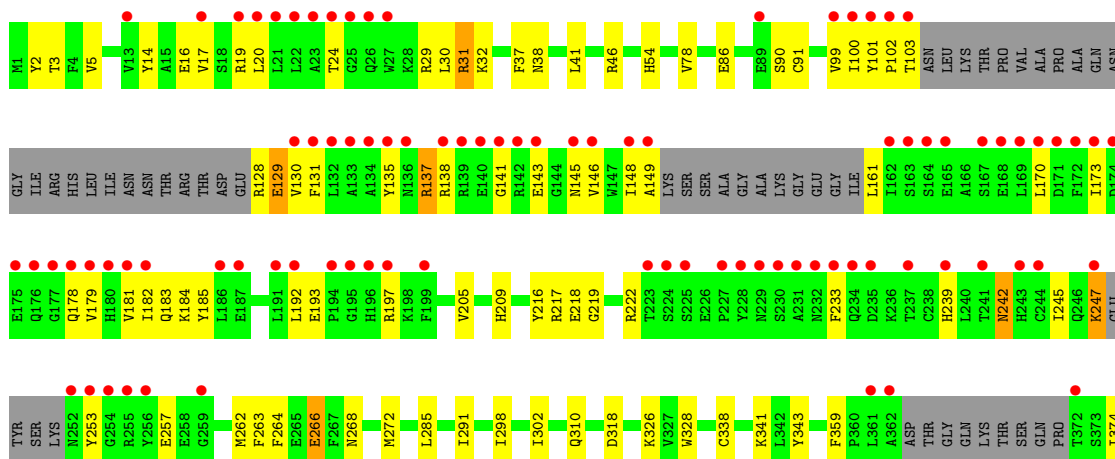

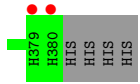

H379
H380
HIS
HIS
HIS
HIS

4 Data and refinement statistics

Property	Value	Source
Space group	P 21 21 21	Depositor
Cell constants a, b, c, α , β , γ	104.93Å 157.61Å 180.99Å 90.00° 90.00° 90.00°	Depositor
Resolution (Å)	49.64 – 2.30 49.64 – 2.30	Depositor EDS
% Data completeness (in resolution range)	97.7 (49.64-2.30) 97.7 (49.64-2.30)	Depositor EDS
R_{merge}	0.13	Depositor
R_{sym}	(Not available)	Depositor
$\langle I/\sigma(I) \rangle$ ¹	1.89 (at 2.32Å)	Xtrriage
Refinement program	PHENIX 1.11.1_2575	Depositor
R, R_{free}	0.194 , 0.235 0.193 , 0.234	Depositor DCC
R_{free} test set	7572 reflections (5.84%)	wwPDB-VP
Wilson B-factor (Å ²)	31.5	Xtrriage
Anisotropy	0.047	Xtrriage
Bulk solvent k_{sol} (e/Å ³), B_{sol} (Å ²)	0.33 , 44.1	EDS
L-test for twinning ²	$\langle L \rangle = 0.50$, $\langle L^2 \rangle = 0.33$	Xtrriage
Estimated twinning fraction	No twinning to report.	Xtrriage
F_o, F_c correlation	0.94	EDS
Total number of atoms	18174	wwPDB-VP
Average B, all atoms (Å ²)	47.0	wwPDB-VP

Xtrriage's analysis on translational NCS is as follows: *The largest off-origin peak in the Patterson function is 2.51% of the height of the origin peak. No significant pseudotranslation is detected.*

¹Intensities estimated from amplitudes.

²Theoretical values of $\langle |L| \rangle$, $\langle L^2 \rangle$ for acentric reflections are 0.5, 0.333 respectively for untwinned datasets, and 0.375, 0.2 for perfectly twinned datasets.

5 Model quality

5.1 Standard geometry

Bond lengths and bond angles in the following residue types are not validated in this section: CA, GTP, GDP, ACP, MG, E3Y, MES

The Z score for a bond length (or angle) is the number of standard deviations the observed value is removed from the expected value. A bond length (or angle) with $|Z| > 5$ is considered an outlier worth inspection. RMSZ is the root-mean-square of all Z scores of the bond lengths (or angles).

Mol	Chain	Bond lengths		Bond angles	
		RMSZ	# Z >5	RMSZ	# Z >5
1	A	0.28	0/3494	0.47	0/4743
1	C	0.31	0/3515	0.49	0/4772
2	B	0.29	0/3436	0.46	0/4654
2	D	0.27	0/3378	0.46	0/4577
3	E	0.27	0/1008	0.39	0/1337
4	F	0.26	0/2779	0.43	0/3756
All	All	0.28	0/17610	0.46	0/23839

There are no bond length outliers.

There are no bond angle outliers.

There are no chirality outliers.

There are no planarity outliers.

5.2 Too-close contacts

In the following table, the Non-H and H(model) columns list the number of non-hydrogen atoms and hydrogen atoms in the chain respectively. The H(added) column lists the number of hydrogen atoms added and optimized by MolProbity. The Clashes column lists the number of clashes within the asymmetric unit, whereas Symm-Clashes lists symmetry-related clashes.

Mol	Chain	Non-H	H(model)	H(added)	Clashes	Symm-Clashes
1	A	3416	0	3330	63	0
1	C	3437	0	3348	50	0
2	B	3361	0	3238	50	0
2	D	3305	0	3179	62	0
3	E	1000	0	1018	24	0
4	F	2717	0	2670	71	0
5	A	32	0	12	1	0

Continued on next page...

Continued from previous page...

Mol	Chain	Non-H	H(model)	H(added)	Clashes	Symm-Clashes
5	C	32	0	12	0	0
6	A	1	0	0	0	0
6	C	1	0	0	0	0
7	A	1	0	0	0	0
7	B	1	0	0	0	0
7	C	1	0	0	0	0
7	F	1	0	0	0	0
8	B	28	0	12	0	0
8	D	28	0	12	4	0
9	B	24	0	24	2	0
10	B	23	0	0	0	0
10	D	23	0	0	0	0
11	F	31	14	13	2	0
12	A	165	0	0	3	0
12	B	127	0	0	2	0
12	C	251	0	0	2	0
12	D	62	0	0	0	0
12	E	30	0	0	0	0
12	F	62	0	0	2	0
All	All	18160	14	16868	312	0

The all-atom clashscore is defined as the number of clashes found per 1000 atoms (including hydrogen atoms). The all-atom clashscore for this structure is 9.

The worst 5 of 312 close contacts within the same asymmetric unit are listed below, sorted by their clash magnitude.

Atom-1	Atom-2	Interatomic distance (Å)	Clash overlap (Å)
4:F:149:ALA:HB3	4:F:161:LEU:HB3	1.48	0.95
1:C:71:GLU:OE2	1:C:73:THR:HB	1.66	0.93
1:C:241:SER:HA	1:C:249:ASN:HD21	1.33	0.90
1:C:71:GLU:HG2	1:C:72:PRO:HD2	1.54	0.89
2:B:238:THR:HB	2:B:316:ILE:HD13	1.57	0.84

There are no symmetry-related clashes.

5.3 Torsion angles [i](#)

5.3.1 Protein backbone [i](#)

In the following table, the Percentiles column shows the percent Ramachandran outliers of the chain as a percentile score with respect to all X-ray entries followed by that with respect to entries of similar resolution.

The Analysed column shows the number of residues for which the backbone conformation was analysed, and the total number of residues.

Mol	Chain	Analysed	Favoured	Allowed	Outliers	Percentiles	
1	A	435/450 (97%)	428 (98%)	6 (1%)	1 (0%)	47	58
1	C	438/450 (97%)	429 (98%)	9 (2%)	0	100	100
2	B	425/445 (96%)	418 (98%)	7 (2%)	0	100	100
2	D	417/445 (94%)	408 (98%)	9 (2%)	0	100	100
3	E	117/143 (82%)	115 (98%)	2 (2%)	0	100	100
4	F	322/384 (84%)	303 (94%)	19 (6%)	0	100	100
All	All	2154/2317 (93%)	2101 (98%)	52 (2%)	1 (0%)	100	100

All (1) Ramachandran outliers are listed below:

Mol	Chain	Res	Type
1	A	162	GLY

5.3.2 Protein sidechains [i](#)

In the following table, the Percentiles column shows the percent sidechain outliers of the chain as a percentile score with respect to all X-ray entries followed by that with respect to entries of similar resolution.

The Analysed column shows the number of residues for which the sidechain conformation was analysed, and the total number of residues.

Mol	Chain	Analysed	Rotameric	Outliers	Percentiles	
1	A	368/378 (97%)	361 (98%)	7 (2%)	57	73
1	C	371/378 (98%)	366 (99%)	5 (1%)	69	82
2	B	369/383 (96%)	365 (99%)	4 (1%)	73	86
2	D	362/383 (94%)	359 (99%)	3 (1%)	81	91
3	E	109/127 (86%)	102 (94%)	7 (6%)	17	23
4	F	296/342 (86%)	286 (97%)	10 (3%)	37	51

Continued on next page...

Continued from previous page...

Mol	Chain	Analysed	Rotameric	Outliers	Percentiles
All	All	1875/1991 (94%)	1839 (98%)	36 (2%)	57 73

5 of 36 residues with a non-rotameric sidechain are listed below:

Mol	Chain	Res	Type
4	F	91	CYS
4	F	266	GLU
4	F	103	THR
4	F	242	ASN
1	C	221	ARG

Sometimes sidechains can be flipped to improve hydrogen bonding and reduce clashes. All (4) such sidechains are listed below:

Mol	Chain	Res	Type
1	C	249	ASN
1	C	356	ASN
2	D	48	ASN
4	F	306	HIS

5.3.3 RNA [i](#)

There are no RNA molecules in this entry.

5.4 Non-standard residues in protein, DNA, RNA chains [i](#)

There are no non-standard protein/DNA/RNA residues in this entry.

5.5 Carbohydrates [i](#)

There are no monosaccharides in this entry.

5.6 Ligand geometry [i](#)

Of 15 ligands modelled in this entry, 6 are monoatomic - leaving 9 for Mogul analysis.

In the following table, the Counts columns list the number of bonds (or angles) for which Mogul statistics could be retrieved, the number of bonds (or angles) that are observed in the model and the number of bonds (or angles) that are defined in the Chemical Component Dictionary. The Link column lists molecule types, if any, to which the group is linked. The Z score for a bond

length (or angle) is the number of standard deviations the observed value is removed from the expected value. A bond length (or angle) with $|Z| > 2$ is considered an outlier worth inspection. RMSZ is the root-mean-square of all Z scores of the bond lengths (or angles).

Mol	Type	Chain	Res	Link	Bond lengths			Bond angles		
					Counts	RMSZ	# Z > 2	Counts	RMSZ	# Z > 2
5	GTP	A	501	7	26,34,34	1.14	2 (7%)	32,54,54	1.39	6 (18%)
8	GDP	D	501	-	24,30,30	0.95	1 (4%)	30,47,47	1.16	2 (6%)
5	GTP	C	501	7	26,34,34	1.10	2 (7%)	32,54,54	1.36	6 (18%)
10	E3Y	B	505	-	26,26,26	0.89	2 (7%)	32,37,37	1.46	3 (9%)
9	MES	B	502	-	12,12,12	2.23	1 (8%)	14,16,16	1.87	4 (28%)
11	ACP	F	402	7	27,33,33	4.72	10 (37%)	32,52,52	2.25	4 (12%)
8	GDP	B	501	7	24,30,30	0.96	1 (4%)	30,47,47	1.14	4 (13%)
9	MES	B	503	-	12,12,12	2.29	1 (8%)	14,16,16	1.92	3 (21%)
10	E3Y	D	502	-	26,26,26	0.90	2 (7%)	32,37,37	1.48	4 (12%)

In the following table, the Chirals column lists the number of chiral outliers, the number of chiral centers analysed, the number of these observed in the model and the number defined in the Chemical Component Dictionary. Similar counts are reported in the Torsion and Rings columns. '2' means no outliers of that kind were identified.

Mol	Type	Chain	Res	Link	Chirals	Torsions	Rings
5	GTP	A	501	7	-	6/18/38/38	0/3/3/3
8	GDP	D	501	-	-	5/12/32/32	0/3/3/3
5	GTP	C	501	7	-	5/18/38/38	0/3/3/3
10	E3Y	B	505	-	-	2/6/16/16	0/4/4/4
9	MES	B	502	-	-	4/6/14/14	0/1/1/1
11	ACP	F	402	7	-	8/15/38/38	0/3/3/3
8	GDP	B	501	7	-	3/12/32/32	0/3/3/3
9	MES	B	503	-	-	1/6/14/14	0/1/1/1
10	E3Y	D	502	-	-	2/6/16/16	0/4/4/4

The worst 5 of 22 bond length outliers are listed below:

Mol	Chain	Res	Type	Atoms	Z	Observed(Å)	Ideal(Å)
11	F	402	ACP	O4'-C1'	15.15	1.62	1.41
11	F	402	ACP	C2'-C1'	-15.03	1.31	1.53
9	B	503	MES	C8-S	-7.66	1.66	1.77
9	B	502	MES	C8-S	-7.45	1.66	1.77
11	F	402	ACP	PB-O3A	6.66	1.65	1.58

The worst 5 of 36 bond angle outliers are listed below:

Mol	Chain	Res	Type	Atoms	Z	Observed(°)	Ideal(°)
11	F	402	ACP	C5-C6-N6	8.20	132.81	120.35
11	F	402	ACP	N3-C2-N1	-5.52	120.05	128.68
11	F	402	ACP	N6-C6-N1	-5.41	107.34	118.57
10	D	502	E3Y	N1-C1-N4	-5.02	125.56	130.62
10	B	505	E3Y	N1-C1-N4	-4.99	125.59	130.62

There are no chirality outliers.

5 of 36 torsion outliers are listed below:

Mol	Chain	Res	Type	Atoms
5	A	501	GTP	PB-O3B-PG-O2G
5	A	501	GTP	C5'-O5'-PA-O1A
5	A	501	GTP	C5'-O5'-PA-O2A
5	C	501	GTP	PB-O3B-PG-O3G
5	C	501	GTP	C5'-O5'-PA-O1A

There are no ring outliers.

5 monomers are involved in 9 short contacts:

Mol	Chain	Res	Type	Clashes	Symm-Clashes
5	A	501	GTP	1	0
8	D	501	GDP	4	0
9	B	502	MES	1	0
11	F	402	ACP	2	0
9	B	503	MES	1	0

The following is a two-dimensional graphical depiction of Mogul quality analysis of bond lengths, bond angles, torsion angles, and ring geometry for all instances of the Ligand of Interest. In addition, ligands with molecular weight > 250 and outliers as shown on the validation Tables will also be included. For torsion angles, if less than 5% of the Mogul distribution of torsion angles is within 10 degrees of the torsion angle in question, then that torsion angle is considered an outlier. Any bond that is central to one or more torsion angles identified as an outlier by Mogul will be highlighted in the graph. For rings, the root-mean-square deviation (RMSD) between the ring in question and similar rings identified by Mogul is calculated over all ring torsion angles. If the average RMSD is greater than 60 degrees and the minimal RMSD between the ring in question and any Mogul-identified rings is also greater than 60 degrees, then that ring is considered an outlier. The outliers are highlighted in purple. The color gray indicates Mogul did not find sufficient equivalents in the CSD to analyse the geometry.

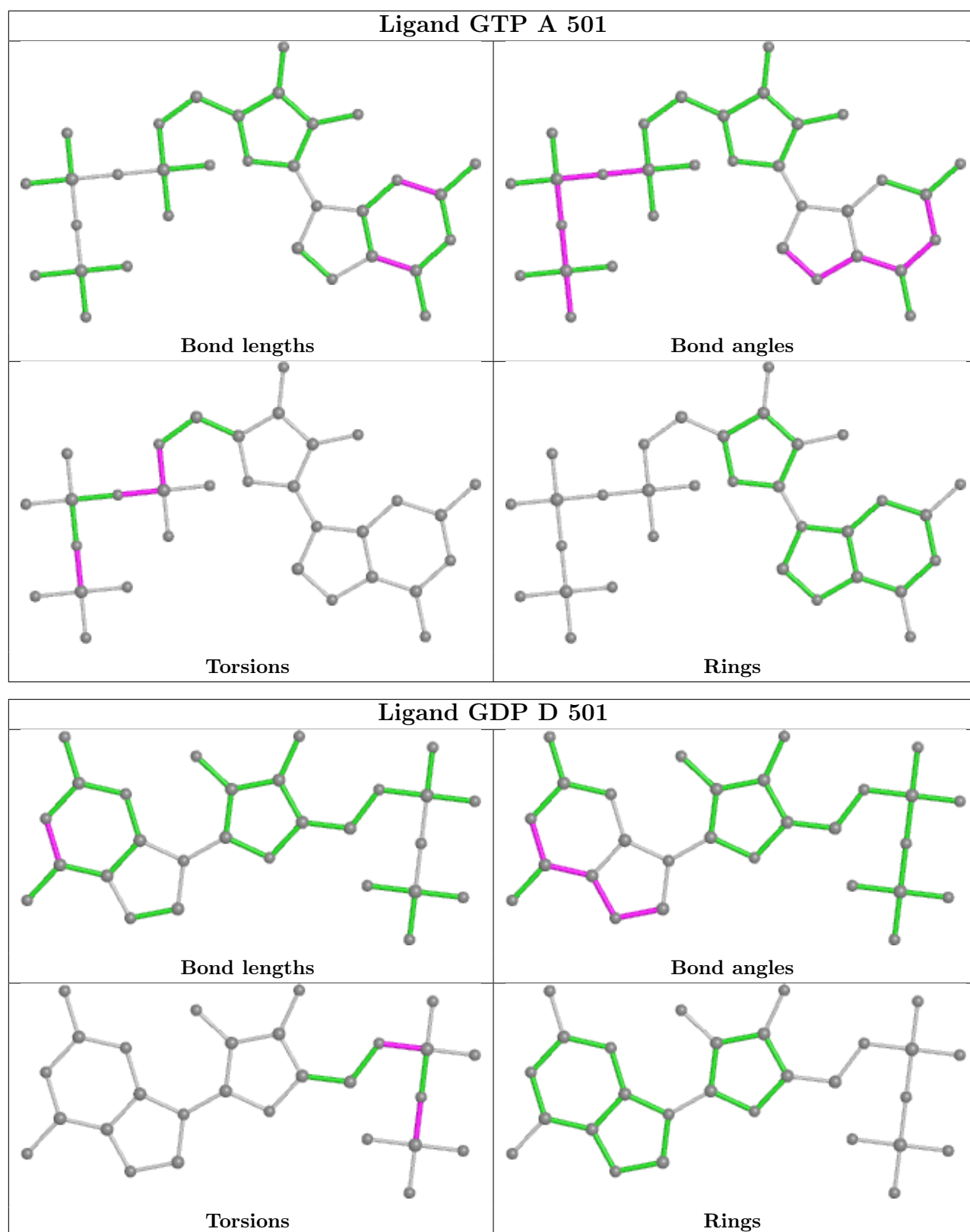

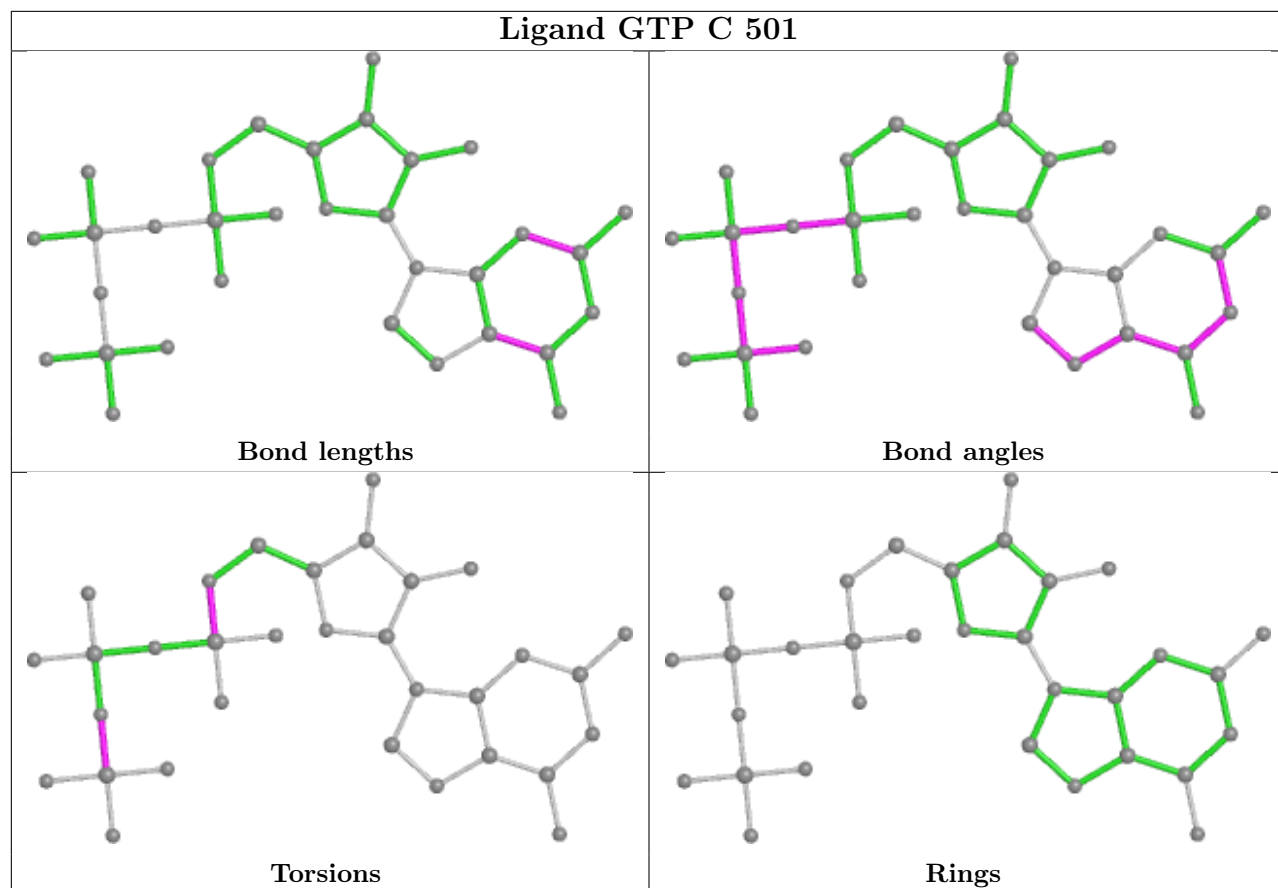

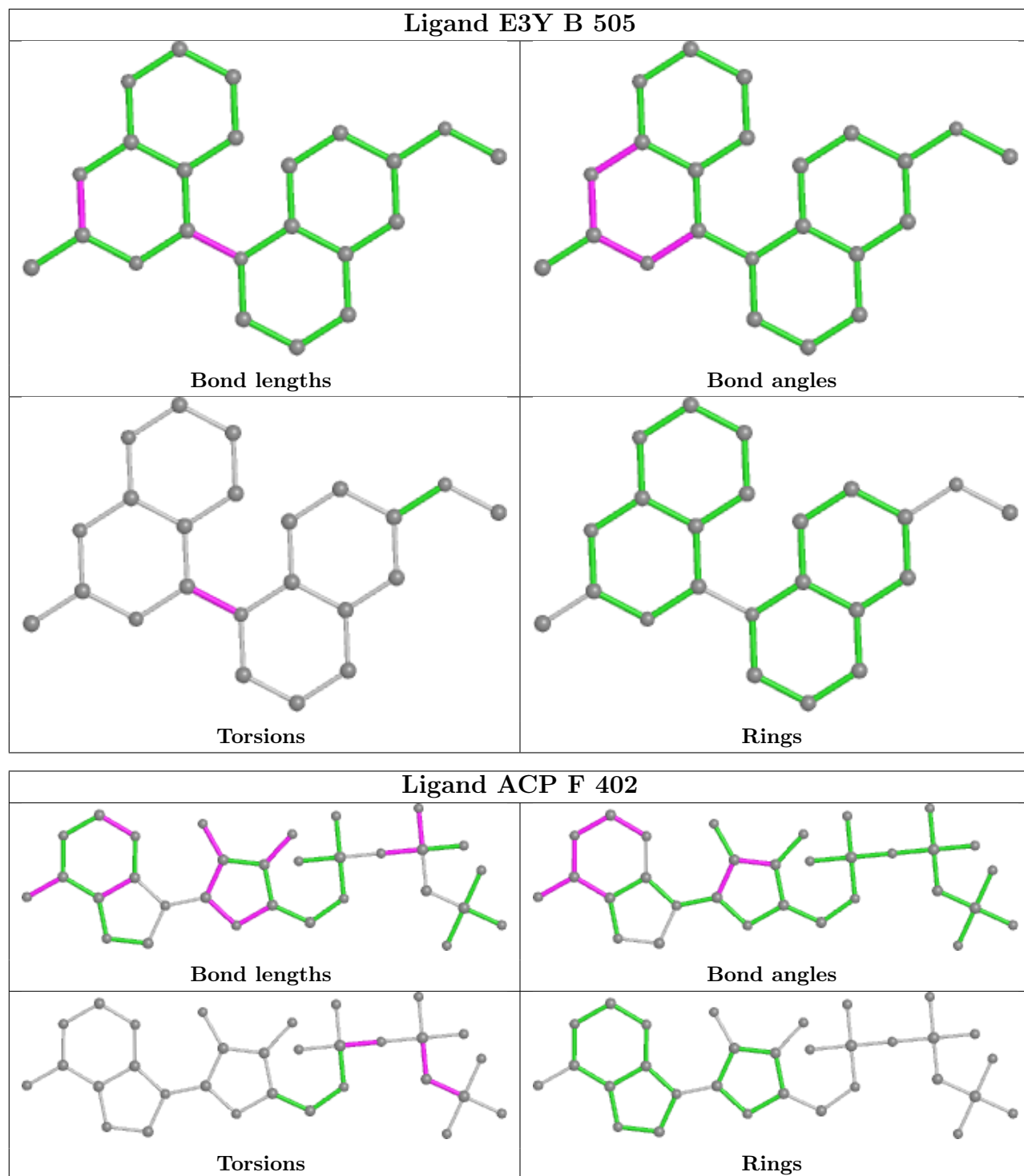

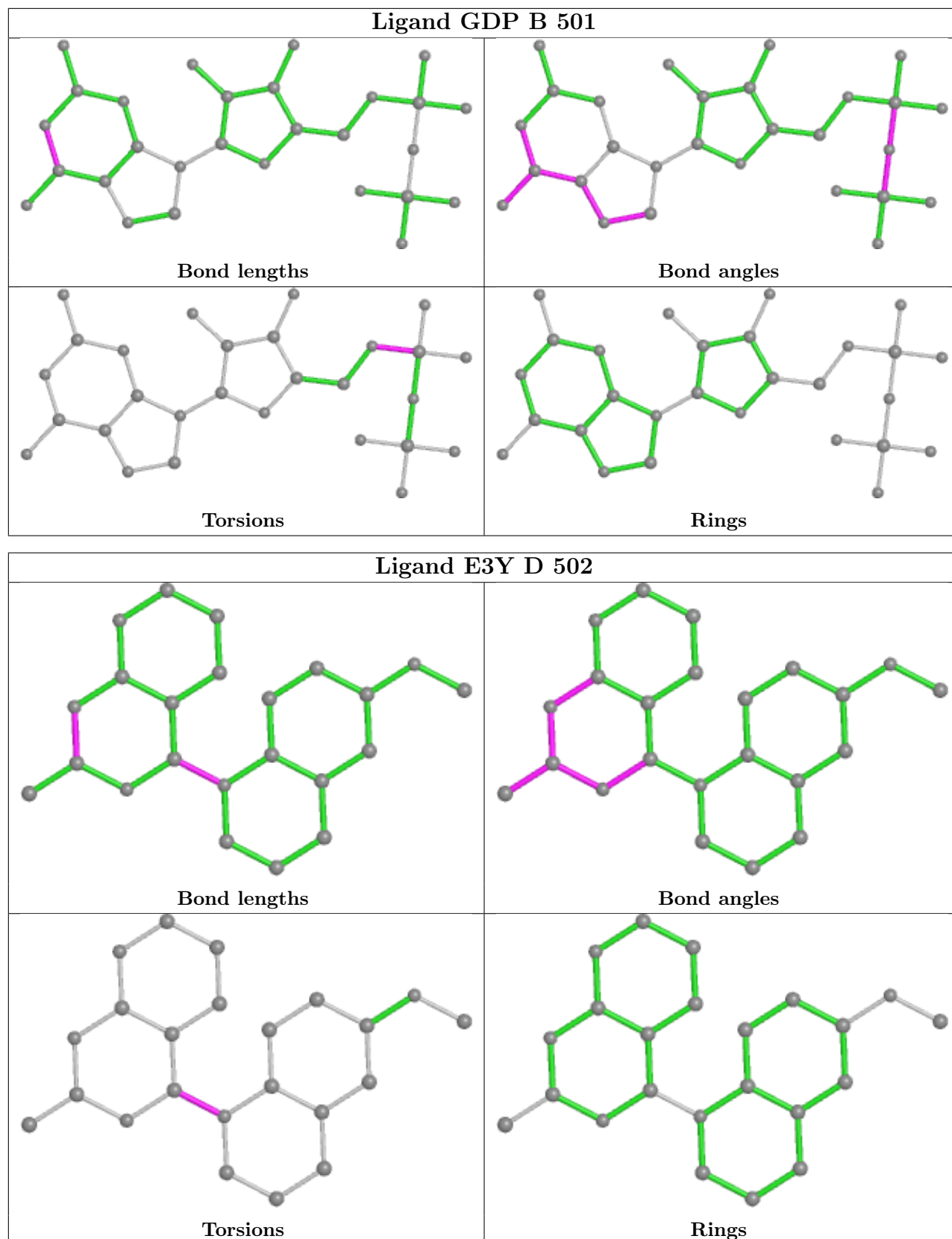

5.7 Other polymers [i](#)

There are no such residues in this entry.

5.8 Polymer linkage issues [i](#)

There are no chain breaks in this entry.

6 Fit of model and data [i](#)

6.1 Protein, DNA and RNA chains [i](#)

In the following table, the column labelled ‘#RSRZ> 2’ contains the number (and percentage) of RSRZ outliers, followed by percent RSRZ outliers for the chain as percentile scores relative to all X-ray entries and entries of similar resolution. The OWAB column contains the minimum, median, 95th percentile and maximum values of the occupancy-weighted average B-factor per residue. The column labelled ‘Q< 0.9’ lists the number of (and percentage) of residues with an average occupancy less than 0.9.

Mol	Chain	Analysed	<RSRZ>	#RSRZ>2	OWAB(Å ²)	Q<0.9
1	A	437/450 (97%)	0.04	8 (1%) 68 74	22, 39, 67, 86	0
1	C	440/450 (97%)	-0.15	1 (0%) 95 96	16, 28, 54, 89	0
2	B	427/445 (95%)	0.05	21 (4%) 29 36	16, 36, 73, 123	0
2	D	421/445 (94%)	0.61	53 (12%) 3 5	26, 55, 93, 131	0
3	E	121/143 (84%)	0.36	14 (11%) 4 6	25, 52, 87, 116	0
4	F	332/384 (86%)	1.16	92 (27%) 0 0	28, 63, 131, 170	0
All	All	2178/2317 (94%)	0.30	189 (8%) 10 14	16, 43, 93, 170	0

The worst 5 of 189 RSRZ outliers are listed below:

Mol	Chain	Res	Type	RSRZ
2	D	55	THR	8.3
4	F	172	PHE	7.7
4	F	253	TYR	6.9
4	F	233	PHE	6.8
2	B	277	GLY	6.8

6.2 Non-standard residues in protein, DNA, RNA chains [i](#)

There are no non-standard protein/DNA/RNA residues in this entry.

6.3 Carbohydrates [i](#)

There are no monosaccharides in this entry.

6.4 Ligands

In the following table, the Atoms column lists the number of modelled atoms in the group and the number defined in the chemical component dictionary. The B-factors column lists the minimum, median, 95th percentile and maximum values of B factors of atoms in the group. The column labelled 'Q< 0.9' lists the number of atoms with occupancy less than 0.9.

Mol	Type	Chain	Res	Atoms	RSCC	RSR	B-factors(Å ²)	Q<0.9
11	ACP	F	402	31/31	0.87	0.17	68,87,102,121	0
8	GDP	D	501	28/28	0.89	0.14	45,55,66,69	0
7	MG	F	401	1/1	0.91	0.12	71,71,71,71	0
10	E3Y	D	502	23/23	0.93	0.16	25,34,51,60	0
9	MES	B	503	12/12	0.94	0.15	54,58,69,72	0
9	MES	B	502	12/12	0.96	0.11	34,44,52,56	0
7	MG	B	504	1/1	0.97	0.19	23,23,23,23	0
8	GDP	B	501	28/28	0.98	0.18	16,26,31,33	0
6	CA	C	502	1/1	0.98	0.04	34,34,34,34	0
7	MG	A	503	1/1	0.98	0.13	23,23,23,23	0
5	GTP	A	501	32/32	0.98	0.18	21,25,30,30	0
10	E3Y	B	505	23/23	0.98	0.12	26,30,34,50	0
7	MG	C	503	1/1	0.98	0.09	22,22,22,22	0
6	CA	A	502	1/1	0.98	0.04	59,59,59,59	0
5	GTP	C	501	32/32	0.99	0.14	21,22,28,31	0

The following is a graphical depiction of the model fit to experimental electron density of all instances of the Ligand of Interest. In addition, ligands with molecular weight > 250 and outliers as shown on the geometry validation Tables will also be included. Each fit is shown from different orientation to approximate a three-dimensional view.

Electron density around ACP F 402:

$2mF_o-DF_c$ (at 0.7 rmsd) in gray
 mF_o-DF_c (at 3 rmsd) in purple (negative)
and green (positive)

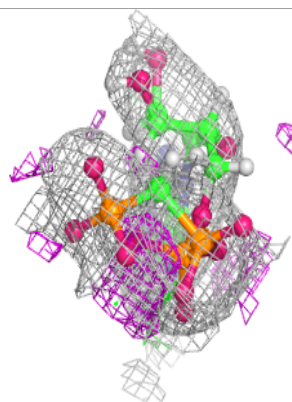
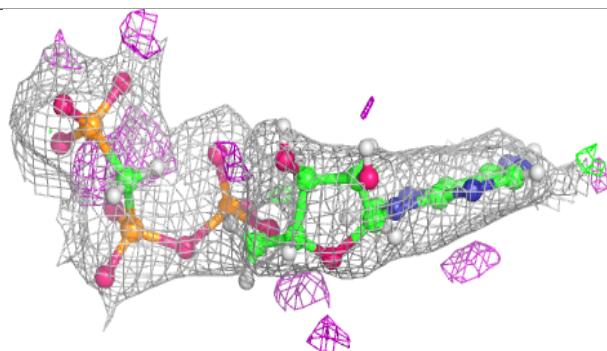
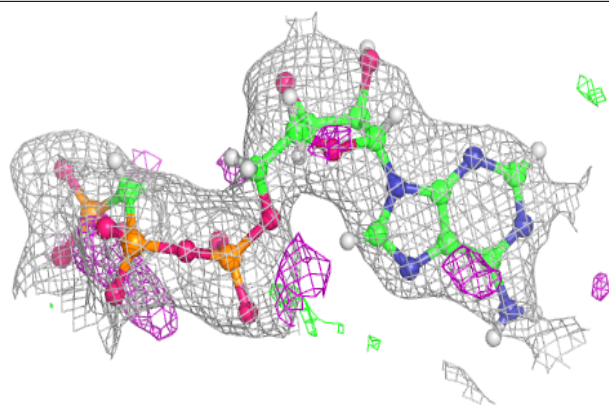
**Electron density around GDP D 501:**

$2mF_o-DF_c$ (at 0.7 rmsd) in gray
 mF_o-DF_c (at 3 rmsd) in purple (negative)
and green (positive)

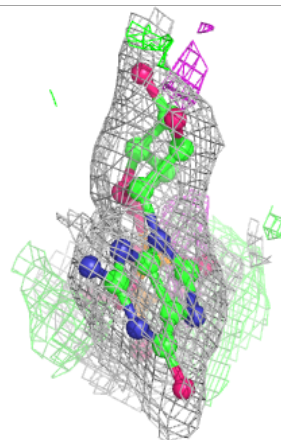
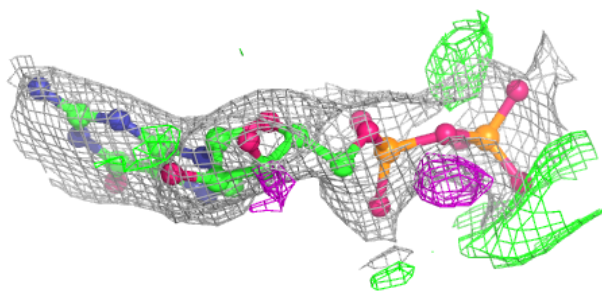
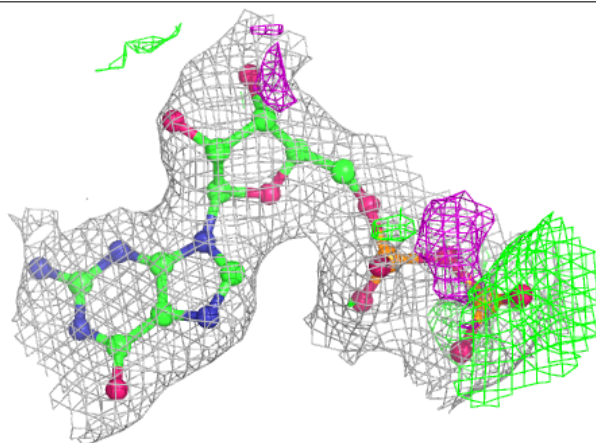

Electron density around E3Y D 502:

$2mF_o-DF_c$ (at 0.7 rmsd) in gray
 mF_o-DF_c (at 3 rmsd) in purple (negative)
and green (positive)

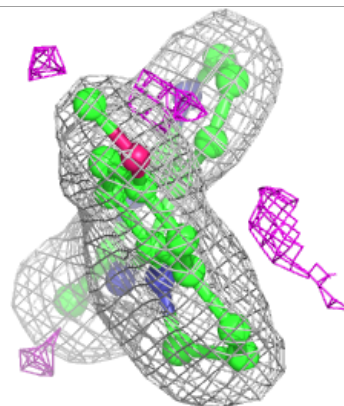
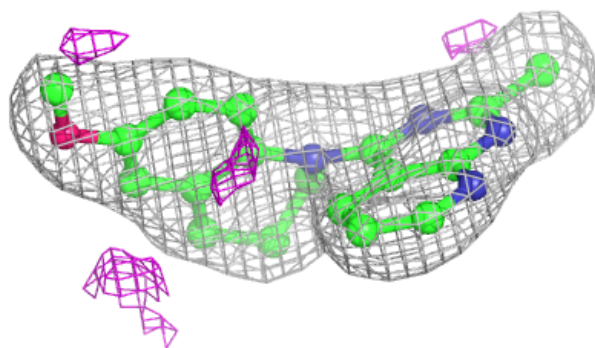
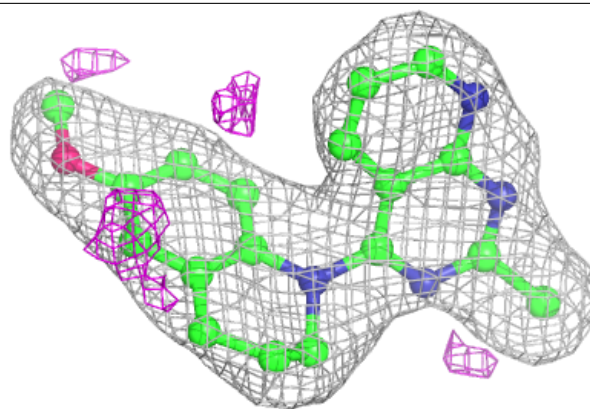
**Electron density around GDP B 501:**

$2mF_o-DF_c$ (at 0.7 rmsd) in gray
 mF_o-DF_c (at 3 rmsd) in purple (negative)
and green (positive)

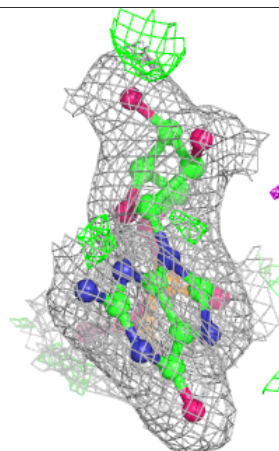
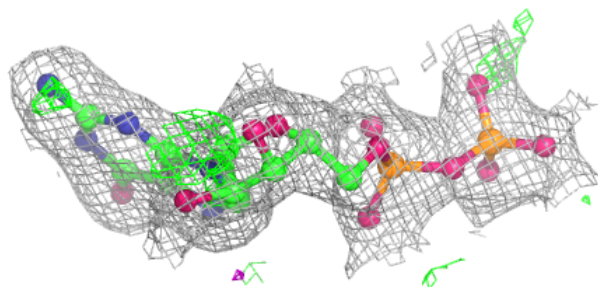
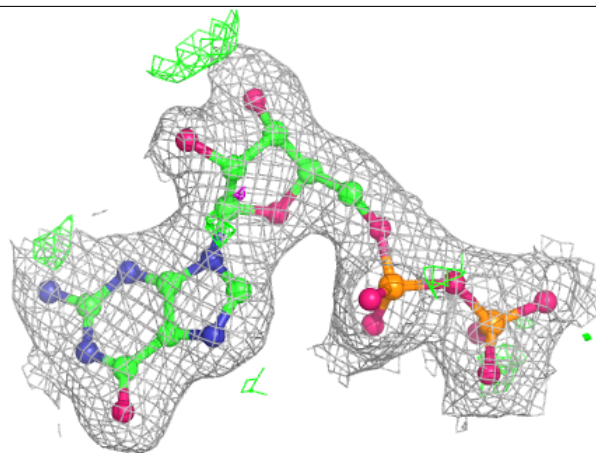

Electron density around GTP A 501:

$2mF_o-DF_c$ (at 0.7 rmsd) in gray
 mF_o-DF_c (at 3 rmsd) in purple (negative)
and green (positive)

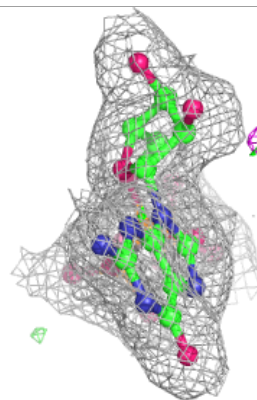
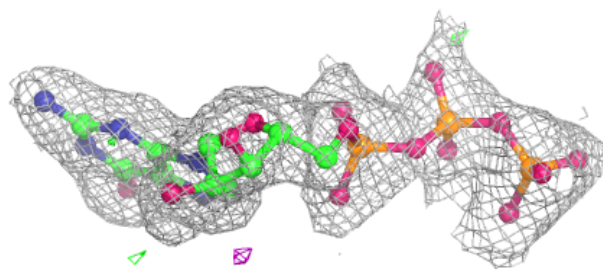
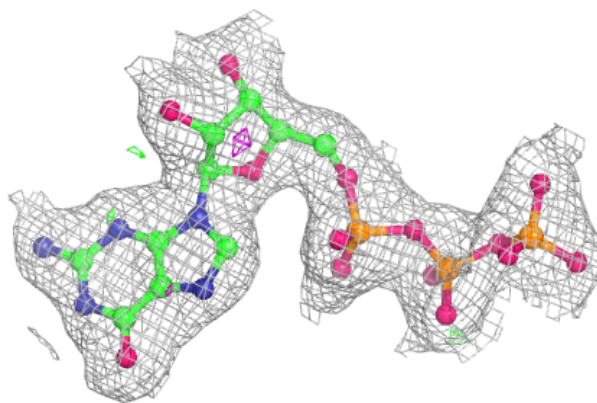
**Electron density around E3Y B 505:**

$2mF_o-DF_c$ (at 0.7 rmsd) in gray
 mF_o-DF_c (at 3 rmsd) in purple (negative)
and green (positive)

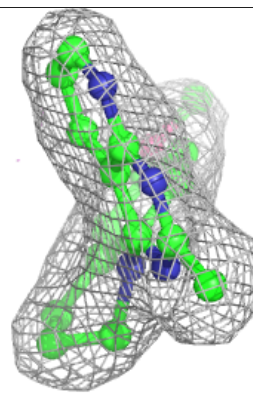
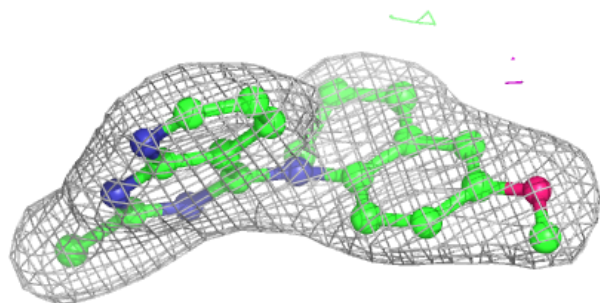
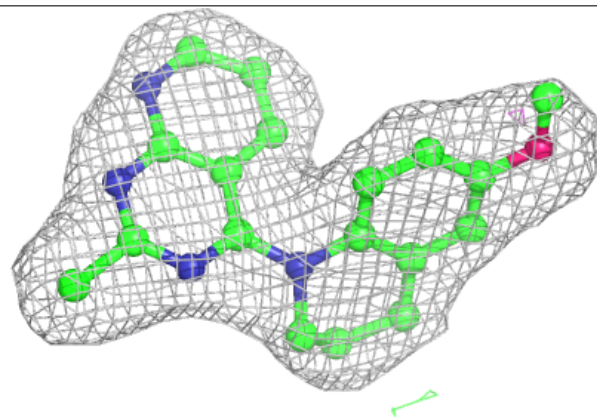

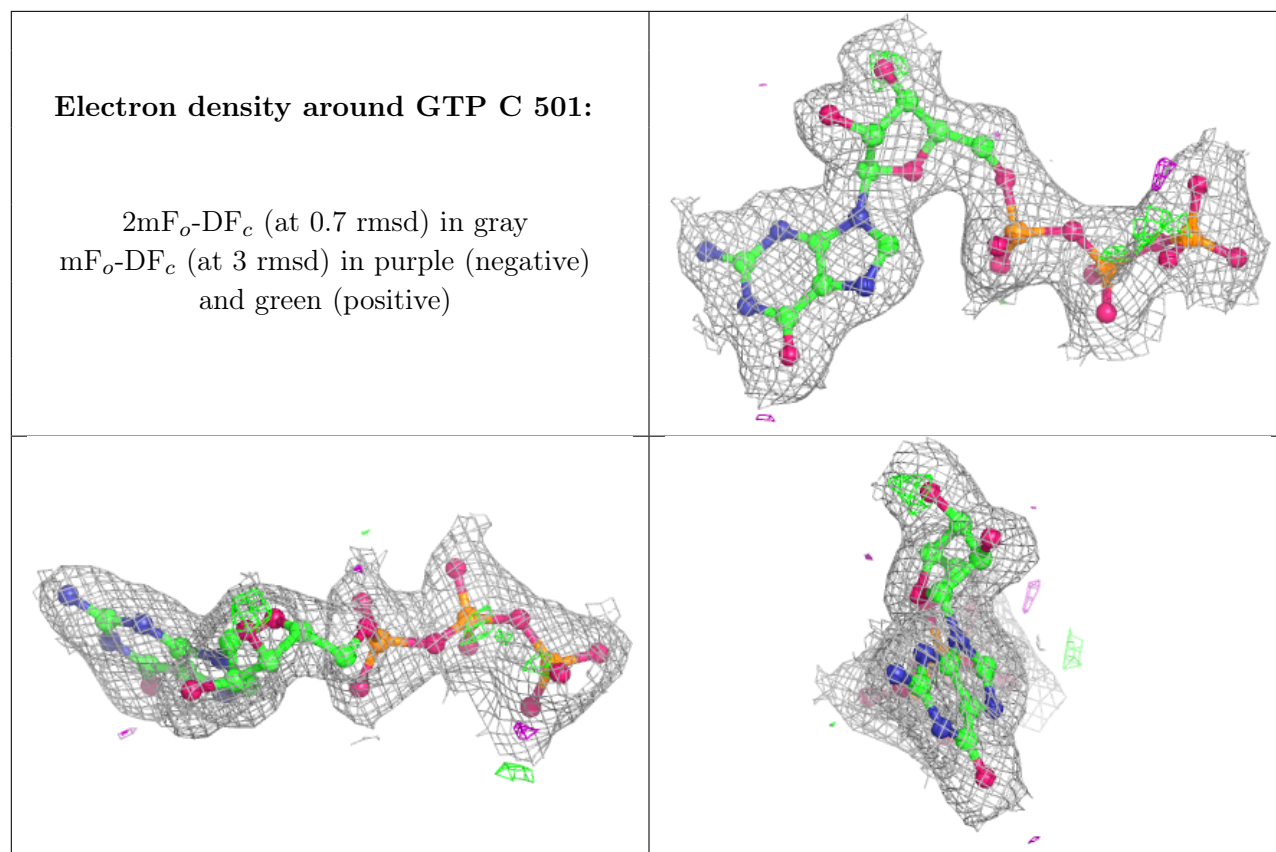

6.5 Other polymers [i](#)

There are no such residues in this entry.