



wwPDB X-ray Structure Validation Summary Report ⓘ

Oct 30, 2023 – 01:02 pm GMT

PDB ID : 8BGI
Title : GABA-A receptor $\alpha 5$ homomer - $\alpha 5V1$ - Flumazenil
Authors : Miller, P.S.; Malinauskas, T.M.; Omari, K.E.; Aricescu, A.R.
Deposited on : 2022-10-27
Resolution : 2.56 Å(reported)

This is a wwPDB X-ray Structure Validation Summary Report for a publicly released PDB entry.

We welcome your comments at validation@mail.wwpdb.org

A user guide is available at

<https://www.wwpdb.org/validation/2017/XrayValidationReportHelp>

with specific help available everywhere you see the ⓘ symbol.

The types of validation reports are described at

<http://www.wwpdb.org/validation/2017/FAQs#types>.

The following versions of software and data (see [references ⓘ](#)) were used in the production of this report:

MolProbity : 4.02b-467
Mogul : 1.8.4, CSD as541be (2020)
Xtriage (Phenix) : 1.13
EDS : 2.36
buster-report : 1.1.7 (2018)
Percentile statistics : 20191225.v01 (using entries in the PDB archive December 25th 2019)
Refmac : 5.8.0158
CCP4 : 7.0.044 (Gargrove)
Ideal geometry (proteins) : Engh & Huber (2001)
Ideal geometry (DNA, RNA) : Parkinson et al. (1996)
Validation Pipeline (wwPDB-VP) : 2.36

1 Overall quality at a glance

The following experimental techniques were used to determine the structure:

X-RAY DIFFRACTION

The reported resolution of this entry is 2.56 Å.

Percentile scores (ranging between 0-100) for global validation metrics of the entry are shown in the following graphic. The table shows the number of entries on which the scores are based.

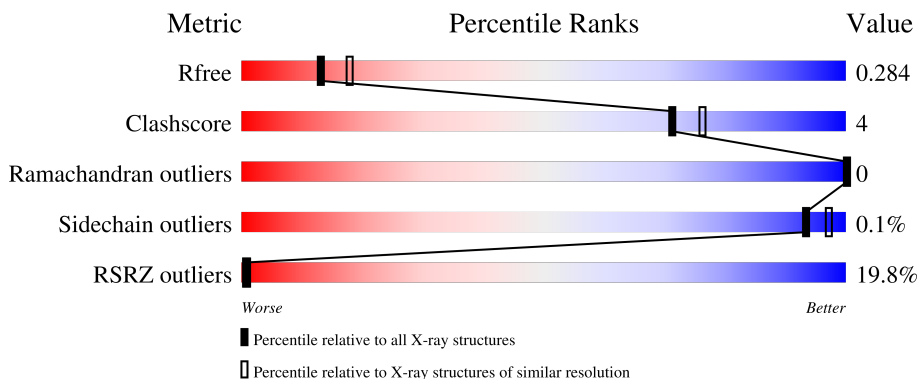

Metric	Whole archive (#Entries)	Similar resolution (#Entries, resolution range(Å))
R_{free}	130704	1279 (2.58-2.54)
Clashscore	141614	1327 (2.58-2.54)
Ramachandran outliers	138981	1312 (2.58-2.54)
Sidechain outliers	138945	1312 (2.58-2.54)
RSRZ outliers	127900	1269 (2.58-2.54)

The table below summarises the geometric issues observed across the polymeric chains and their fit to the electron density. The red, orange, yellow and green segments of the lower bar indicate the fraction of residues that contain outliers for ≥ 3 , 2, 1 and 0 types of geometric quality criteria respectively. A grey segment represents the fraction of residues that are not modelled. The numeric value for each fraction is indicated below the corresponding segment, with a dot representing fractions $\leq 5\%$. The upper red bar (where present) indicates the fraction of residues that have poor fit to the electron density. The numeric value is given above the bar.

Mol	Chain	Length	Quality of chain
1	A	361	
1	B	361	
1	C	361	
1	D	361	
1	E	361	

The following table lists non-polymeric compounds, carbohydrate monomers and non-standard residues in protein, DNA, RNA chains that are outliers for geometric or electron-density-fit criteria:

Mol	Type	Chain	Res	Chirality	Geometry	Clashes	Electron density
2	SO4	C	501	-	-	X	-

2 Entry composition [i](#)

There are 6 unique types of molecules in this entry. The entry contains 27623 atoms, of which 13621 are hydrogens and 0 are deuteriums.

In the tables below, the ZeroOcc column contains the number of atoms modelled with zero occupancy, the AltConf column contains the number of residues with at least one atom in alternate conformation and the Trace column contains the number of residues modelled with at most 2 atoms.

- Molecule 1 is a protein called Gamma-aminobutyric acid receptor subunit alpha-5.

Mol	Chain	Residues	Atoms						ZeroOcc	AltConf	Trace
			Total	C	H	N	O	S			
1	A	335	5366	1746	2661	448	493	18	0	0	0
1	B	335	5364	1746	2659	448	493	18	0	0	0
1	C	335	5366	1746	2661	448	493	18	0	0	0
1	D	335	5366	1746	2661	448	493	18	0	0	0
1	E	335	5366	1746	2661	448	493	18	0	0	0

There are 215 discrepancies between the modelled and reference sequences:

Chain	Residue	Modelled	Actual	Comment	Reference
A	48	MET	ILE	conflict	UNP P31644
A	51	ASN	THR	conflict	UNP P31644
A	67	ILE	VAL	conflict	UNP P31644
A	70	ALA	ARG	conflict	UNP P31644
A	72	THR	SER	conflict	UNP P31644
A	90	ASP	ASN	conflict	UNP P31644
A	92	ARG	LEU	conflict	UNP P31644
A	93	VAL	LEU	conflict	UNP P31644
A	95	ASP	SER	conflict	UNP P31644
A	96	GLN	LYS	conflict	UNP P31644
A	107	ASP	GLY	conflict	UNP P31644
A	111	PHE	ILE	conflict	UNP P31644
A	114	GLY	ASN	conflict	UNP P31644
A	121	MET	LEU	conflict	UNP P31644
A	124	ILE	LEU	conflict	UNP P31644
A	125	TRP	GLU	conflict	UNP P31644
A	126	ASN	ASP	conflict	UNP P31644
A	129	ARG	THR	conflict	UNP P31644
A	130	VAL	LEU	conflict	UNP P31644

Continued on next page...

Continued from previous page...

Chain	Residue	Modelled	Actual	Comment	Reference
A	145	ASP	GLN	conflict	UNP P31644
A	153	GLU	ALA	conflict	UNP P31644
A	154	GLN	HIS	conflict	UNP P31644
A	155	ASN	ALA	conflict	UNP P31644
A	316	SER	-	linker	UNP P31644
A	317	GLN	-	linker	UNP P31644
A	318	PRO	-	linker	UNP P31644
A	319	ALA	-	linker	UNP P31644
A	320	ARG	-	linker	UNP P31644
A	321	ALA	-	linker	UNP P31644
A	322	ALA	-	linker	UNP P31644
A	404	ILE	VAL	engineered mutation	UNP P31644
A	420	ARG	-	expression tag	UNP P31644
A	421	GLY	-	expression tag	UNP P31644
A	422	THR	-	expression tag	UNP P31644
A	423	THR	-	expression tag	UNP P31644
A	424	GLU	-	expression tag	UNP P31644
A	425	THR	-	expression tag	UNP P31644
A	426	SER	-	expression tag	UNP P31644
A	427	GLN	-	expression tag	UNP P31644
A	428	VAL	-	expression tag	UNP P31644
A	429	ALA	-	expression tag	UNP P31644
A	430	PRO	-	expression tag	UNP P31644
A	431	ALA	-	expression tag	UNP P31644
B	48	MET	ILE	conflict	UNP P31644
B	51	ASN	THR	conflict	UNP P31644
B	67	ILE	VAL	conflict	UNP P31644
B	70	ALA	ARG	conflict	UNP P31644
B	72	THR	SER	conflict	UNP P31644
B	90	ASP	ASN	conflict	UNP P31644
B	92	ARG	LEU	conflict	UNP P31644
B	93	VAL	LEU	conflict	UNP P31644
B	95	ASP	SER	conflict	UNP P31644
B	96	GLN	LYS	conflict	UNP P31644
B	107	ASP	GLY	conflict	UNP P31644
B	111	PHE	ILE	conflict	UNP P31644
B	114	GLY	ASN	conflict	UNP P31644
B	121	MET	LEU	conflict	UNP P31644
B	124	ILE	LEU	conflict	UNP P31644
B	125	TRP	GLU	conflict	UNP P31644
B	126	ASN	ASP	conflict	UNP P31644
B	129	ARG	THR	conflict	UNP P31644

Continued on next page...

Continued from previous page...

Chain	Residue	Modelled	Actual	Comment	Reference
B	130	VAL	LEU	conflict	UNP P31644
B	145	ASP	GLN	conflict	UNP P31644
B	153	GLU	ALA	conflict	UNP P31644
B	154	GLN	HIS	conflict	UNP P31644
B	155	ASN	ALA	conflict	UNP P31644
B	316	SER	-	linker	UNP P31644
B	317	GLN	-	linker	UNP P31644
B	318	PRO	-	linker	UNP P31644
B	319	ALA	-	linker	UNP P31644
B	320	ARG	-	linker	UNP P31644
B	321	ALA	-	linker	UNP P31644
B	322	ALA	-	linker	UNP P31644
B	404	ILE	VAL	engineered mutation	UNP P31644
B	420	ARG	-	expression tag	UNP P31644
B	421	GLY	-	expression tag	UNP P31644
B	422	THR	-	expression tag	UNP P31644
B	423	THR	-	expression tag	UNP P31644
B	424	GLU	-	expression tag	UNP P31644
B	425	THR	-	expression tag	UNP P31644
B	426	SER	-	expression tag	UNP P31644
B	427	GLN	-	expression tag	UNP P31644
B	428	VAL	-	expression tag	UNP P31644
B	429	ALA	-	expression tag	UNP P31644
B	430	PRO	-	expression tag	UNP P31644
B	431	ALA	-	expression tag	UNP P31644
C	48	MET	ILE	conflict	UNP P31644
C	51	ASN	THR	conflict	UNP P31644
C	67	ILE	VAL	conflict	UNP P31644
C	70	ALA	ARG	conflict	UNP P31644
C	72	THR	SER	conflict	UNP P31644
C	90	ASP	ASN	conflict	UNP P31644
C	92	ARG	LEU	conflict	UNP P31644
C	93	VAL	LEU	conflict	UNP P31644
C	95	ASP	SER	conflict	UNP P31644
C	96	GLN	LYS	conflict	UNP P31644
C	107	ASP	GLY	conflict	UNP P31644
C	111	PHE	ILE	conflict	UNP P31644
C	114	GLY	ASN	conflict	UNP P31644
C	121	MET	LEU	conflict	UNP P31644
C	124	ILE	LEU	conflict	UNP P31644
C	125	TRP	GLU	conflict	UNP P31644
C	126	ASN	ASP	conflict	UNP P31644

Continued on next page...

Continued from previous page...

Chain	Residue	Modelled	Actual	Comment	Reference
C	129	ARG	THR	conflict	UNP P31644
C	130	VAL	LEU	conflict	UNP P31644
C	145	ASP	GLN	conflict	UNP P31644
C	153	GLU	ALA	conflict	UNP P31644
C	154	GLN	HIS	conflict	UNP P31644
C	155	ASN	ALA	conflict	UNP P31644
C	316	SER	-	linker	UNP P31644
C	317	GLN	-	linker	UNP P31644
C	318	PRO	-	linker	UNP P31644
C	319	ALA	-	linker	UNP P31644
C	320	ARG	-	linker	UNP P31644
C	321	ALA	-	linker	UNP P31644
C	322	ALA	-	linker	UNP P31644
C	404	ILE	VAL	engineered mutation	UNP P31644
C	420	ARG	-	expression tag	UNP P31644
C	421	GLY	-	expression tag	UNP P31644
C	422	THR	-	expression tag	UNP P31644
C	423	THR	-	expression tag	UNP P31644
C	424	GLU	-	expression tag	UNP P31644
C	425	THR	-	expression tag	UNP P31644
C	426	SER	-	expression tag	UNP P31644
C	427	GLN	-	expression tag	UNP P31644
C	428	VAL	-	expression tag	UNP P31644
C	429	ALA	-	expression tag	UNP P31644
C	430	PRO	-	expression tag	UNP P31644
C	431	ALA	-	expression tag	UNP P31644
D	48	MET	ILE	conflict	UNP P31644
D	51	ASN	THR	conflict	UNP P31644
D	67	ILE	VAL	conflict	UNP P31644
D	70	ALA	ARG	conflict	UNP P31644
D	72	THR	SER	conflict	UNP P31644
D	90	ASP	ASN	conflict	UNP P31644
D	92	ARG	LEU	conflict	UNP P31644
D	93	VAL	LEU	conflict	UNP P31644
D	95	ASP	SER	conflict	UNP P31644
D	96	GLN	LYS	conflict	UNP P31644
D	107	ASP	GLY	conflict	UNP P31644
D	111	PHE	ILE	conflict	UNP P31644
D	114	GLY	ASN	conflict	UNP P31644
D	121	MET	LEU	conflict	UNP P31644
D	124	ILE	LEU	conflict	UNP P31644
D	125	TRP	GLU	conflict	UNP P31644

Continued on next page...

Continued from previous page...

Chain	Residue	Modelled	Actual	Comment	Reference
D	126	ASN	ASP	conflict	UNP P31644
D	129	ARG	THR	conflict	UNP P31644
D	130	VAL	LEU	conflict	UNP P31644
D	145	ASP	GLN	conflict	UNP P31644
D	153	GLU	ALA	conflict	UNP P31644
D	154	GLN	HIS	conflict	UNP P31644
D	155	ASN	ALA	conflict	UNP P31644
D	316	SER	-	linker	UNP P31644
D	317	GLN	-	linker	UNP P31644
D	318	PRO	-	linker	UNP P31644
D	319	ALA	-	linker	UNP P31644
D	320	ARG	-	linker	UNP P31644
D	321	ALA	-	linker	UNP P31644
D	322	ALA	-	linker	UNP P31644
D	404	ILE	VAL	engineered mutation	UNP P31644
D	420	ARG	-	expression tag	UNP P31644
D	421	GLY	-	expression tag	UNP P31644
D	422	THR	-	expression tag	UNP P31644
D	423	THR	-	expression tag	UNP P31644
D	424	GLU	-	expression tag	UNP P31644
D	425	THR	-	expression tag	UNP P31644
D	426	SER	-	expression tag	UNP P31644
D	427	GLN	-	expression tag	UNP P31644
D	428	VAL	-	expression tag	UNP P31644
D	429	ALA	-	expression tag	UNP P31644
D	430	PRO	-	expression tag	UNP P31644
D	431	ALA	-	expression tag	UNP P31644
E	48	MET	ILE	conflict	UNP P31644
E	51	ASN	THR	conflict	UNP P31644
E	67	ILE	VAL	conflict	UNP P31644
E	70	ALA	ARG	conflict	UNP P31644
E	72	THR	SER	conflict	UNP P31644
E	90	ASP	ASN	conflict	UNP P31644
E	92	ARG	LEU	conflict	UNP P31644
E	93	VAL	LEU	conflict	UNP P31644
E	95	ASP	SER	conflict	UNP P31644
E	96	GLN	LYS	conflict	UNP P31644
E	107	ASP	GLY	conflict	UNP P31644
E	111	PHE	ILE	conflict	UNP P31644
E	114	GLY	ASN	conflict	UNP P31644
E	121	MET	LEU	conflict	UNP P31644
E	124	ILE	LEU	conflict	UNP P31644

Continued on next page...

Continued from previous page...

Chain	Residue	Modelled	Actual	Comment	Reference
E	125	TRP	GLU	conflict	UNP P31644
E	126	ASN	ASP	conflict	UNP P31644
E	129	ARG	THR	conflict	UNP P31644
E	130	VAL	LEU	conflict	UNP P31644
E	145	ASP	GLN	conflict	UNP P31644
E	153	GLU	ALA	conflict	UNP P31644
E	154	GLN	HIS	conflict	UNP P31644
E	155	ASN	ALA	conflict	UNP P31644
E	316	SER	-	linker	UNP P31644
E	317	GLN	-	linker	UNP P31644
E	318	PRO	-	linker	UNP P31644
E	319	ALA	-	linker	UNP P31644
E	320	ARG	-	linker	UNP P31644
E	321	ALA	-	linker	UNP P31644
E	322	ALA	-	linker	UNP P31644
E	404	ILE	VAL	engineered mutation	UNP P31644
E	420	ARG	-	expression tag	UNP P31644
E	421	GLY	-	expression tag	UNP P31644
E	422	THR	-	expression tag	UNP P31644
E	423	THR	-	expression tag	UNP P31644
E	424	GLU	-	expression tag	UNP P31644
E	425	THR	-	expression tag	UNP P31644
E	426	SER	-	expression tag	UNP P31644
E	427	GLN	-	expression tag	UNP P31644
E	428	VAL	-	expression tag	UNP P31644
E	429	ALA	-	expression tag	UNP P31644
E	430	PRO	-	expression tag	UNP P31644
E	431	ALA	-	expression tag	UNP P31644

- Molecule 2 is SULFATE ION (three-letter code: SO4) (formula: O₄S).



Mol	Chain	Residues	Atoms			ZeroOcc	AltConf
2	A	1	Total	O	S	0	0
			5	4	1		
2	A	1	Total	O	S	0	0
			5	4	1		
2	A	1	Total	O	S	0	0
			5	4	1		
2	A	1	Total	O	S	0	0
			5	4	1		
2	A	1	Total	O	S	0	0
			5	4	1		
2	A	1	Total	O	S	0	0
			5	4	1		
2	B	1	Total	O	S	0	0
			5	4	1		
2	B	1	Total	O	S	0	0
			5	4	1		
2	B	1	Total	O	S	0	0
			5	4	1		
2	B	1	Total	O	S	0	0
			5	4	1		
2	B	1	Total	O	S	0	0
			5	4	1		
2	C	1	Total	O	S	0	0
			5	4	1		

Continued on next page...

Continued from previous page...

Mol	Chain	Residues	Atoms			ZeroOcc	AltConf
2	C	1	Total	O	S	0	0
			5	4	1		
2	C	1	Total	O	S	0	0
			5	4	1		
2	C	1	Total	O	S	0	0
			5	4	1		
2	C	1	Total	O	S	0	0
			5	4	1		
2	D	1	Total	O	S	0	0
			5	4	1		
2	D	1	Total	O	S	0	0
			5	4	1		
2	D	1	Total	O	S	0	0
			5	4	1		
2	D	1	Total	O	S	0	0
			5	4	1		
2	D	1	Total	O	S	0	0
			5	4	1		
2	E	1	Total	O	S	0	0
			5	4	1		
2	E	1	Total	O	S	0	0
			5	4	1		
2	E	1	Total	O	S	0	0
			5	4	1		
2	E	1	Total	O	S	0	0
			5	4	1		
2	E	1	Total	O	S	0	0
			5	4	1		

- Molecule 3 is ethyl 8-fluoro-5-methyl-6-oxo-5,6-dihydro-4H-imidazo[1,5-a][1,4]benzodiazepine-3-carboxylate (three-letter code: FYP) (formula: C₁₅H₁₄FN₃O₃) (labeled as "Ligand of Interest" by depositor).

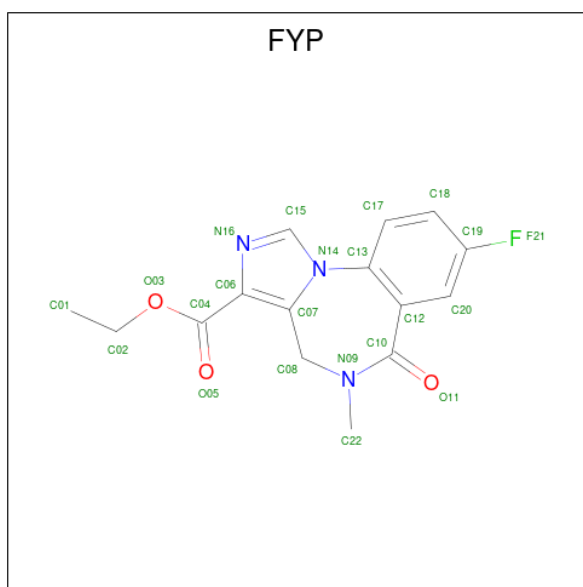

Mol	Chain	Residues	Atoms					ZeroOcc	AltConf	
			Total	C	F	H	N			O
3	A	1	Total	C	F	H	N	O	0	0
			36	15	1	14	3	3		
3	B	1	Total	C	F	H	N	O	0	0
			36	15	1	14	3	3		
3	C	1	Total	C	F	H	N	O	0	0
			36	15	1	14	3	3		
3	D	1	Total	C	F	H	N	O	0	0
			36	15	1	14	3	3		
3	E	1	Total	C	F	H	N	O	0	0
			36	15	1	14	3	3		

- Molecule 4 is Pregnanolone (three-letter code: P9N) (formula: $C_{21}H_{34}O_2$).

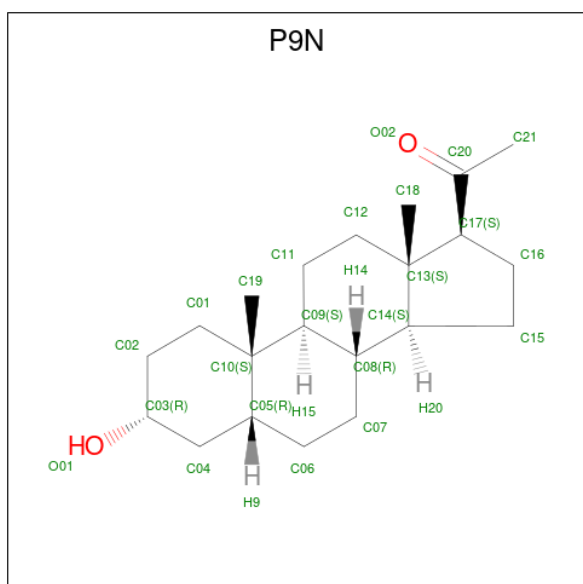

Mol	Chain	Residues	Atoms				ZeroOcc	AltConf
4	A	1	Total	C	H	O	0	0
			57	21	34	2		
4	B	1	Total	C	H	O	0	0
			57	21	34	2		
4	C	1	Total	C	H	O	0	0
			57	21	34	2		
4	D	1	Total	C	H	O	0	0
			57	21	34	2		
4	E	1	Total	C	H	O	0	0
			57	21	34	2		

- Molecule 5 is 2-acetamido-2-deoxy-beta-D-glucopyranose (three-letter code: NAG) (formula: $C_8H_{15}NO_6$).

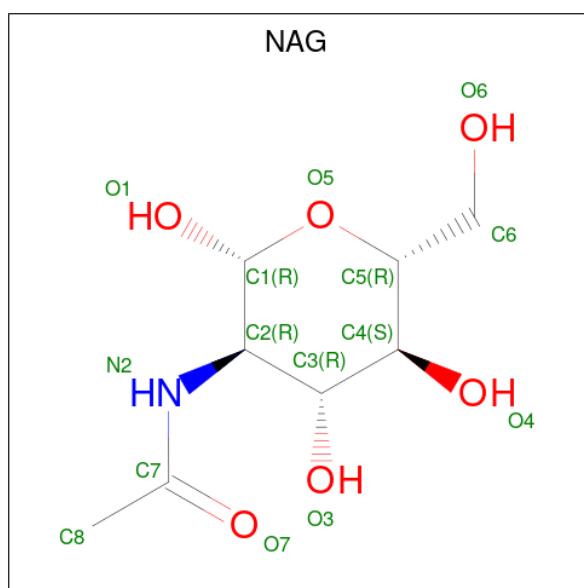

Mol	Chain	Residues	Atoms					ZeroOcc	AltConf
5	A	1	Total	C	H	N	O	0	0
			27	8	13	1	5		
5	B	1	Total	C	H	N	O	0	0
			27	8	13	1	5		
5	B	1	Total	C	H	N	O	0	0
			27	8	13	1	5		
5	C	1	Total	C	H	N	O	0	0
			27	8	13	1	5		
5	D	1	Total	C	H	N	O	0	0
			27	8	13	1	5		
5	E	1	Total	C	H	N	O	0	0
			27	8	13	1	5		

- Molecule 6 is water.

Mol	Chain	Residues	Atoms	ZeroOcc	AltConf
6	A	8	Total O 8 8	0	0
6	B	4	Total O 4 4	0	0
6	C	5	Total O 5 5	0	0
6	D	2	Total O 2 2	0	0
6	E	4	Total O 4 4	0	0

3 Residue-property plots [i](#)

These plots are drawn for all protein, RNA, DNA and oligosaccharide chains in the entry. The first graphic for a chain summarises the proportions of the various outlier classes displayed in the second graphic. The second graphic shows the sequence view annotated by issues in geometry and electron density. Residues are color-coded according to the number of geometric quality criteria for which they contain at least one outlier: green = 0, yellow = 1, orange = 2 and red = 3 or more. A red dot above a residue indicates a poor fit to the electron density ($RSRZ > 2$). Stretches of 2 or more consecutive residues without any outlier are shown as a green connector. Residues present in the sample, but not in the model, are shown in grey.

- Molecule 1: Gamma-aminobutyric acid receptor subunit alpha-5

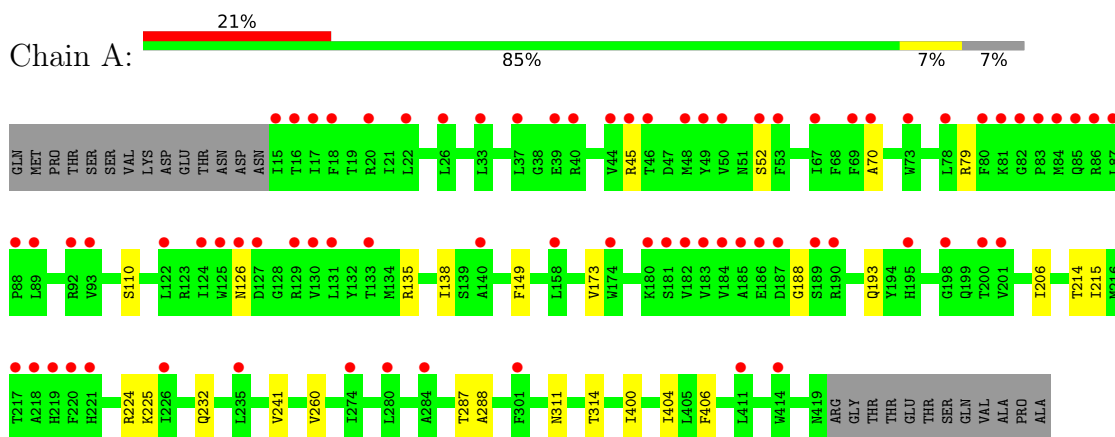

- Molecule 1: Gamma-aminobutyric acid receptor subunit alpha-5

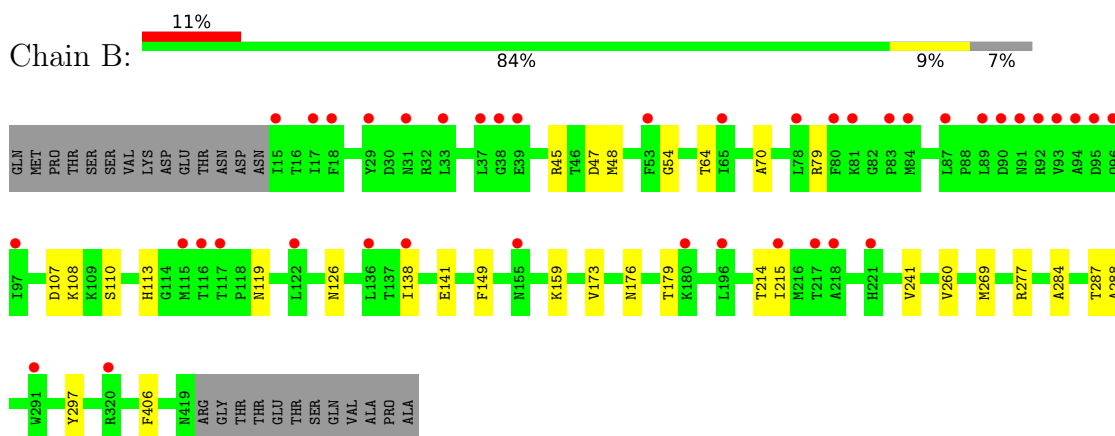

- Molecule 1: Gamma-aminobutyric acid receptor subunit alpha-5

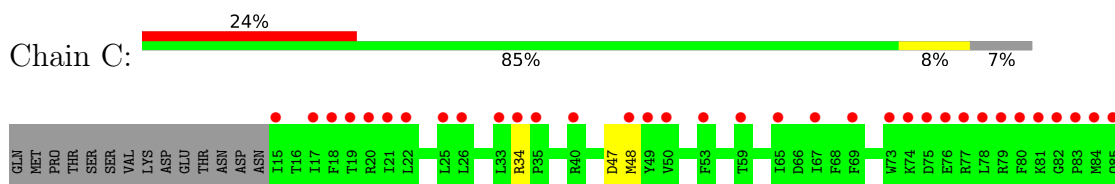

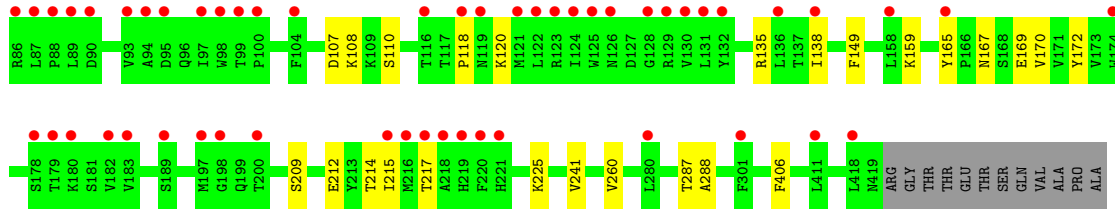

● Molecule 1: Gamma-aminobutyric acid receptor subunit alpha-5

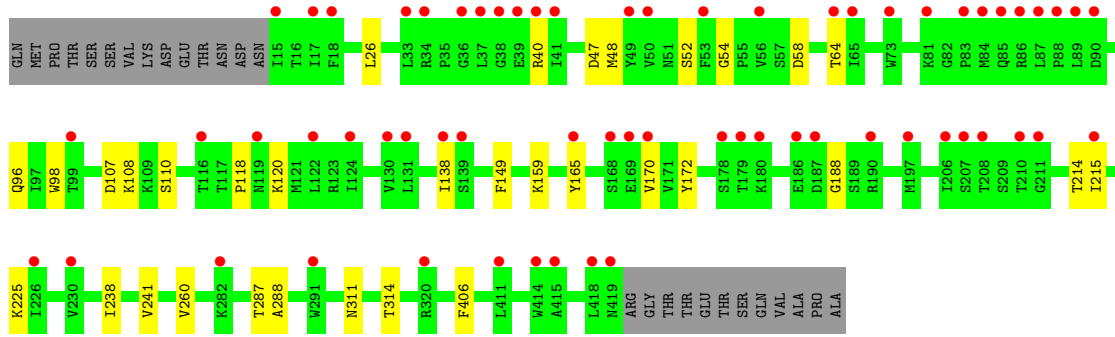
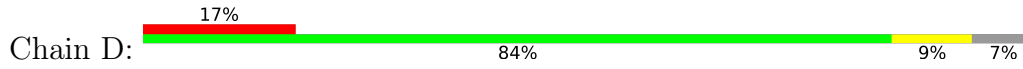

● Molecule 1: Gamma-aminobutyric acid receptor subunit alpha-5

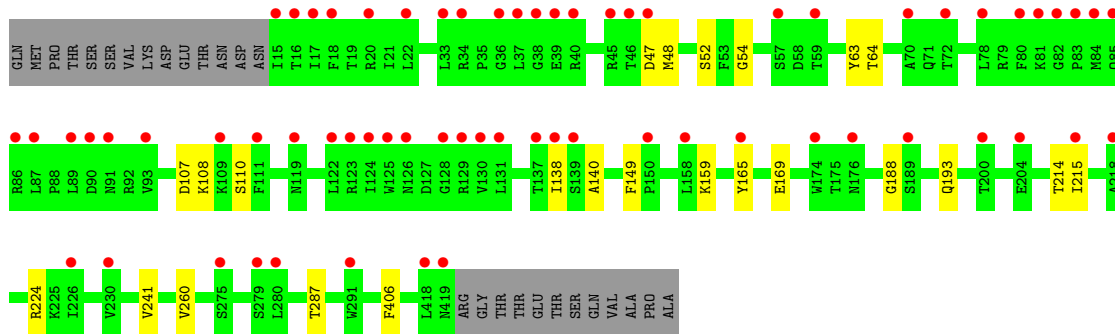
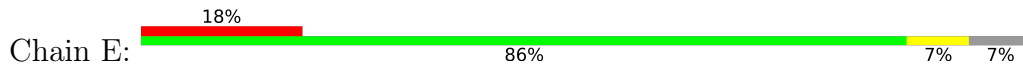

4 Data and refinement statistics

Property	Value	Source
Space group	C 1 2 1	Depositor
Cell constants a, b, c, α , β , γ	200.77Å 131.64Å 119.17Å 90.00° 100.19° 90.00°	Depositor
Resolution (Å)	47.56 – 2.56 69.73 – 2.83	Depositor EDS
% Data completeness (in resolution range)	92.2 (47.56-2.56) 46.6 (69.73-2.83)	Depositor EDS
R_{merge}	(Not available)	Depositor
R_{sym}	(Not available)	Depositor
$\langle I/\sigma(I) \rangle$ ¹	1.39 (at 2.81Å)	Xtrriage
Refinement program	REFMAC 1.20.1_4487, PHENIX 1.20.1_4487	Depositor
R, R_{free}	0.254 , 0.277 0.265 , 0.284	Depositor DCC
R_{free} test set	1641 reflections (4.84%)	wwPDB-VP
Wilson B-factor (Å ²)	62.8	Xtrriage
Anisotropy	0.017	Xtrriage
Bulk solvent k_{sol} (e/Å ³), B_{sol} (Å ²)	0.37 , 31.2	EDS
L-test for twinning ²	$\langle L \rangle = 0.49$, $\langle L^2 \rangle = 0.32$	Xtrriage
Estimated twinning fraction	No twinning to report.	Xtrriage
F_o, F_c correlation	0.86	EDS
Total number of atoms	27623	wwPDB-VP
Average B, all atoms (Å ²)	74.0	wwPDB-VP

Xtrriage's analysis on translational NCS is as follows: *The largest off-origin peak in the Patterson function is 5.13% of the height of the origin peak. No significant pseudotranslation is detected.*

¹Intensities estimated from amplitudes.

²Theoretical values of $\langle |L| \rangle$, $\langle L^2 \rangle$ for acentric reflections are 0.5, 0.333 respectively for untwinned datasets, and 0.375, 0.2 for perfectly twinned datasets.

5 Model quality [i](#)

5.1 Standard geometry [i](#)

Bond lengths and bond angles in the following residue types are not validated in this section: NAG, SO4, P9N, FYP

The Z score for a bond length (or angle) is the number of standard deviations the observed value is removed from the expected value. A bond length (or angle) with $|Z| > 5$ is considered an outlier worth inspection. RMSZ is the root-mean-square of all Z scores of the bond lengths (or angles).

Mol	Chain	Bond lengths		Bond angles	
		RMSZ	# Z >5	RMSZ	# Z >5
1	A	0.26	0/2776	0.49	0/3776
1	B	0.26	0/2776	0.49	0/3776
1	C	0.25	0/2776	0.48	0/3776
1	D	0.28	0/2776	0.48	0/3776
1	E	0.25	0/2776	0.48	0/3776
All	All	0.26	0/13880	0.48	0/18880

There are no bond length outliers.

There are no bond angle outliers.

There are no chirality outliers.

There are no planarity outliers.

5.2 Too-close contacts [i](#)

In the following table, the Non-H and H(model) columns list the number of non-hydrogen atoms and hydrogen atoms in the chain respectively. The H(added) column lists the number of hydrogen atoms added and optimized by MolProbity. The Clashes column lists the number of clashes within the asymmetric unit, whereas Symm-Clashes lists symmetry-related clashes.

Mol	Chain	Non-H	H(model)	H(added)	Clashes	Symm-Clashes
1	A	2705	2661	2667	20	0
1	B	2705	2659	2666	26	0
1	C	2705	2661	2667	21	0
1	D	2705	2661	2667	24	0
1	E	2705	2661	2667	15	0
2	A	30	0	0	0	0
2	B	35	0	0	0	0
2	C	25	0	0	3	0

Continued on next page...

Continued from previous page...

Mol	Chain	Non-H	H(model)	H(added)	Clashes	Symm-Clashes
2	D	25	0	0	1	0
2	E	30	0	0	0	0
3	A	22	14	0	0	0
3	B	22	14	0	1	0
3	C	22	14	0	1	0
3	D	22	14	0	0	0
3	E	22	14	0	0	0
4	A	23	34	0	0	0
4	B	23	34	0	0	0
4	C	23	34	0	0	0
4	D	23	34	0	0	0
4	E	23	34	0	0	0
5	A	14	13	13	0	0
5	B	28	26	26	1	0
5	C	14	13	13	0	0
5	D	14	13	13	0	0
5	E	14	13	13	0	0
6	A	8	0	0	0	0
6	B	4	0	0	0	0
6	C	5	0	0	0	0
6	D	2	0	0	0	0
6	E	4	0	0	0	0
All	All	14002	13621	13412	97	0

The all-atom clashscore is defined as the number of clashes found per 1000 atoms (including hydrogen atoms). The all-atom clashscore for this structure is 4.

The worst 5 of 97 close contacts within the same asymmetric unit are listed below, sorted by their clash magnitude.

Atom-1	Atom-2	Interatomic distance (Å)	Clash overlap (Å)
1:A:206:ILE:HD13	1:A:215:ILE:HD12	1.59	0.84
1:C:225:LYS:NZ	2:C:501:SO4:O2	2.11	0.81
1:D:165:TYR:HD2	1:D:170:VAL:HG21	1.51	0.75
1:C:225:LYS:NZ	2:C:501:SO4:S	2.66	0.68
1:B:149:PHE:HB3	1:B:287:THR:HG23	1.79	0.64

There are no symmetry-related clashes.

5.3 Torsion angles [i](#)

5.3.1 Protein backbone [i](#)

In the following table, the Percentiles column shows the percent Ramachandran outliers of the chain as a percentile score with respect to all X-ray entries followed by that with respect to entries of similar resolution.

The Analysed column shows the number of residues for which the backbone conformation was analysed, and the total number of residues.

Mol	Chain	Analysed	Favoured	Allowed	Outliers	Percentiles	
1	A	333/361 (92%)	323 (97%)	10 (3%)	0	100	100
1	B	333/361 (92%)	323 (97%)	10 (3%)	0	100	100
1	C	333/361 (92%)	323 (97%)	10 (3%)	0	100	100
1	D	333/361 (92%)	322 (97%)	11 (3%)	0	100	100
1	E	333/361 (92%)	323 (97%)	10 (3%)	0	100	100
All	All	1665/1805 (92%)	1614 (97%)	51 (3%)	0	100	100

There are no Ramachandran outliers to report.

5.3.2 Protein sidechains [i](#)

In the following table, the Percentiles column shows the percent sidechain outliers of the chain as a percentile score with respect to all X-ray entries followed by that with respect to entries of similar resolution.

The Analysed column shows the number of residues for which the sidechain conformation was analysed, and the total number of residues.

Mol	Chain	Analysed	Rotameric	Outliers	Percentiles	
1	A	298/321 (93%)	298 (100%)	0	100	100
1	B	298/321 (93%)	298 (100%)	0	100	100
1	C	298/321 (93%)	298 (100%)	0	100	100
1	D	298/321 (93%)	297 (100%)	1 (0%)	92	96
1	E	298/321 (93%)	298 (100%)	0	100	100
All	All	1490/1605 (93%)	1489 (100%)	1 (0%)	93	97

All (1) residues with a non-rotameric sidechain are listed below:

Mol	Chain	Res	Type
1	D	40	ARG

Sometimes sidechains can be flipped to improve hydrogen bonding and reduce clashes. All (2) such sidechains are listed below:

Mol	Chain	Res	Type
1	C	311	ASN
1	E	195	HIS

5.3.3 RNA [i](#)

There are no RNA molecules in this entry.

5.4 Non-standard residues in protein, DNA, RNA chains [i](#)

There are no non-standard protein/DNA/RNA residues in this entry.

5.5 Carbohydrates [i](#)

There are no monosaccharides in this entry.

5.6 Ligand geometry [i](#)

45 ligands are modelled in this entry.

In the following table, the Counts columns list the number of bonds (or angles) for which Mogul statistics could be retrieved, the number of bonds (or angles) that are observed in the model and the number of bonds (or angles) that are defined in the Chemical Component Dictionary. The Link column lists molecule types, if any, to which the group is linked. The Z score for a bond length (or angle) is the number of standard deviations the observed value is removed from the expected value. A bond length (or angle) with $|Z| > 2$ is considered an outlier worth inspection. RMSZ is the root-mean-square of all Z scores of the bond lengths (or angles).

Mol	Type	Chain	Res	Link	Bond lengths			Bond angles		
					Counts	RMSZ	# Z > 2	Counts	RMSZ	# Z > 2
2	SO4	A	502	-	4,4,4	0.15	0	6,6,6	0.05	0
2	SO4	E	503	-	4,4,4	0.14	0	6,6,6	0.12	0
3	FYP	D	506	-	22,24,24	0.75	1 (4%)	26,35,35	1.19	2 (7%)
4	P9N	C	507	-	26,26,26	0.16	0	42,42,42	0.27	0
5	NAG	B	511	1	14,14,15	0.51	0	17,19,21	0.86	1 (5%)
2	SO4	B	503	-	4,4,4	0.13	0	6,6,6	0.13	0

Mol	Type	Chain	Res	Link	Bond lengths			Bond angles		
					Counts	RMSZ	# Z > 2	Counts	RMSZ	# Z > 2
4	P9N	D	507	-	26,26,26	0.14	0	42,42,42	0.27	0
5	NAG	C	508	1	14,14,15	0.50	0	17,19,21	0.78	0
2	SO4	B	501	-	4,4,4	0.15	0	6,6,6	0.08	0
2	SO4	B	505	-	4,4,4	0.14	0	6,6,6	0.06	0
2	SO4	A	505	-	4,4,4	0.15	0	6,6,6	0.04	0
2	SO4	E	505	-	4,4,4	0.14	0	6,6,6	0.10	0
3	FYP	E	501	-	22,24,24	0.80	1 (4%)	26,35,35	1.21	3 (11%)
2	SO4	A	501	-	4,4,4	0.14	0	6,6,6	0.05	0
2	SO4	D	501	-	4,4,4	0.14	0	6,6,6	0.07	0
2	SO4	C	502	-	4,4,4	0.13	0	6,6,6	0.12	0
2	SO4	D	503	-	4,4,4	0.14	0	6,6,6	0.11	0
4	P9N	A	508	-	26,26,26	0.13	0	42,42,42	0.28	0
2	SO4	A	506	-	4,4,4	0.14	0	6,6,6	0.10	0
2	SO4	B	506	-	4,4,4	0.13	0	6,6,6	0.07	0
2	SO4	E	502	-	4,4,4	0.14	0	6,6,6	0.06	0
3	FYP	B	508	-	22,24,24	0.74	0	26,35,35	1.24	2 (7%)
2	SO4	E	506	-	4,4,4	0.15	0	6,6,6	0.05	0
2	SO4	A	503	-	4,4,4	0.14	0	6,6,6	0.18	0
2	SO4	C	505	-	4,4,4	0.14	0	6,6,6	0.08	0
5	NAG	B	510	1	14,14,15	0.50	0	17,19,21	0.77	0
3	FYP	A	507	-	22,24,24	0.80	2 (9%)	26,35,35	1.28	2 (7%)
5	NAG	A	509	1	14,14,15	0.46	0	17,19,21	0.86	1 (5%)
5	NAG	E	509	1	14,14,15	0.48	0	17,19,21	0.77	0
2	SO4	B	504	-	4,4,4	0.15	0	6,6,6	0.09	0
4	P9N	B	509	-	26,26,26	0.14	0	42,42,42	0.29	0
2	SO4	B	507	-	4,4,4	0.14	0	6,6,6	0.09	0
2	SO4	E	507	-	4,4,4	0.13	0	6,6,6	0.12	0
4	P9N	E	508	-	26,26,26	0.19	0	42,42,42	0.31	0
5	NAG	D	508	1	14,14,15	0.50	0	17,19,21	0.86	1 (5%)
2	SO4	E	504	-	4,4,4	0.14	0	6,6,6	0.12	0
2	SO4	C	504	-	4,4,4	0.13	0	6,6,6	0.09	0
2	SO4	D	505	-	4,4,4	0.13	0	6,6,6	0.10	0
2	SO4	C	501	-	4,4,4	0.14	0	6,6,6	0.08	0
2	SO4	A	504	-	4,4,4	0.13	0	6,6,6	0.18	0
2	SO4	D	504	-	4,4,4	0.14	0	6,6,6	0.09	0
2	SO4	D	502	-	4,4,4	0.14	0	6,6,6	0.12	0
3	FYP	C	506	-	22,24,24	0.74	0	26,35,35	1.23	2 (7%)
2	SO4	C	503	-	4,4,4	0.13	0	6,6,6	0.12	0
2	SO4	B	502	-	4,4,4	0.15	0	6,6,6	0.09	0

In the following table, the Chirals column lists the number of chiral outliers, the number of chiral centers analysed, the number of these observed in the model and the number defined in the

Chemical Component Dictionary. Similar counts are reported in the Torsion and Rings columns.
'-' means no outliers of that kind were identified.

Mol	Type	Chain	Res	Link	Chirals	Torsions	Rings
4	P9N	D	507	-	-	0/4/62/62	0/4/4/4
4	P9N	E	508	-	-	0/4/62/62	0/4/4/4
4	P9N	A	508	-	-	0/4/62/62	0/4/4/4
3	FYP	D	506	-	-	0/7/23/23	0/2/3/3
5	NAG	D	508	1	-	1/6/23/26	0/1/1/1
4	P9N	C	507	-	-	0/4/62/62	0/4/4/4
3	FYP	B	508	-	-	0/7/23/23	0/2/3/3
5	NAG	B	510	1	-	1/6/23/26	0/1/1/1
5	NAG	B	511	1	-	1/6/23/26	0/1/1/1
3	FYP	E	501	-	-	2/7/23/23	0/2/3/3
3	FYP	A	507	-	-	0/7/23/23	0/2/3/3
5	NAG	A	509	1	-	1/6/23/26	0/1/1/1
4	P9N	B	509	-	-	0/4/62/62	0/4/4/4
3	FYP	C	506	-	-	0/7/23/23	0/2/3/3
5	NAG	E	509	1	-	0/6/23/26	0/1/1/1
5	NAG	C	508	1	-	1/6/23/26	0/1/1/1

All (4) bond length outliers are listed below:

Mol	Chain	Res	Type	Atoms	Z	Observed(Å)	Ideal(Å)
3	E	501	FYP	C08-C07	-2.23	1.48	1.51
3	D	506	FYP	C15-N16	-2.04	1.31	1.35
3	A	507	FYP	C08-C07	-2.03	1.48	1.51
3	A	507	FYP	C15-N16	-2.01	1.31	1.35

The worst 5 of 14 bond angle outliers are listed below:

Mol	Chain	Res	Type	Atoms	Z	Observed(°)	Ideal(°)
3	A	507	FYP	C08-N09-C10	4.45	124.54	120.94
3	B	508	FYP	C08-N09-C10	4.40	124.51	120.94
3	D	506	FYP	C08-N09-C10	4.08	124.25	120.94
3	C	506	FYP	C08-N09-C10	4.06	124.23	120.94
3	E	501	FYP	C08-N09-C10	3.46	123.75	120.94

There are no chirality outliers.

5 of 7 torsion outliers are listed below:

Mol	Chain	Res	Type	Atoms
3	E	501	FYP	C06-C04-O03-C02
5	B	511	NAG	O5-C5-C6-O6

Continued on next page...

Continued from previous page...

Mol	Chain	Res	Type	Atoms
5	D	508	NAG	O5-C5-C6-O6
5	B	510	NAG	O5-C5-C6-O6
5	C	508	NAG	O5-C5-C6-O6

There are no ring outliers.

6 monomers are involved in 7 short contacts:

Mol	Chain	Res	Type	Clashes	Symm-Clashes
2	D	501	SO4	1	0
3	B	508	FYP	1	0
5	B	510	NAG	1	0
2	C	504	SO4	1	0
2	C	501	SO4	2	0
3	C	506	FYP	1	0

The following is a two-dimensional graphical depiction of Mogul quality analysis of bond lengths, bond angles, torsion angles, and ring geometry for all instances of the Ligand of Interest. In addition, ligands with molecular weight > 250 and outliers as shown on the validation Tables will also be included. For torsion angles, if less than 5% of the Mogul distribution of torsion angles is within 10 degrees of the torsion angle in question, then that torsion angle is considered an outlier. Any bond that is central to one or more torsion angles identified as an outlier by Mogul will be highlighted in the graph. For rings, the root-mean-square deviation (RMSD) between the ring in question and similar rings identified by Mogul is calculated over all ring torsion angles. If the average RMSD is greater than 60 degrees and the minimal RMSD between the ring in question and any Mogul-identified rings is also greater than 60 degrees, then that ring is considered an outlier. The outliers are highlighted in purple. The color gray indicates Mogul did not find sufficient equivalents in the CSD to analyse the geometry.

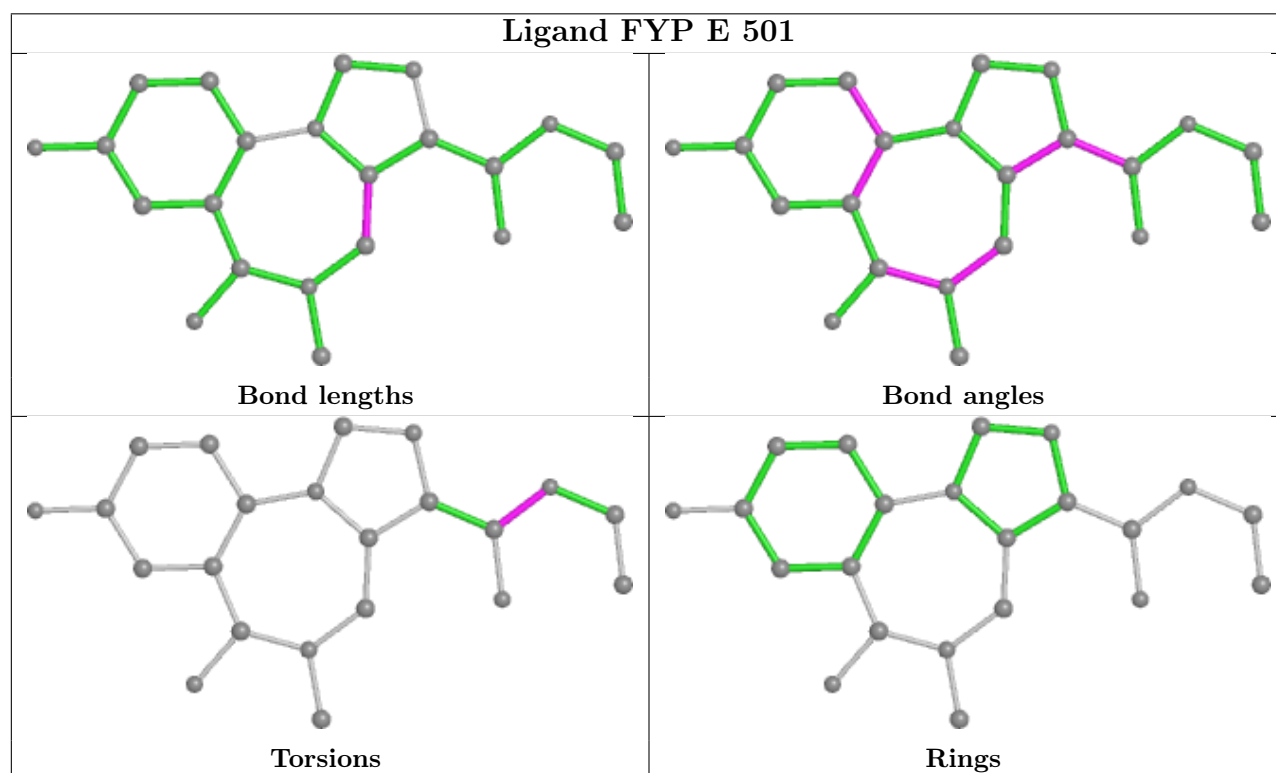
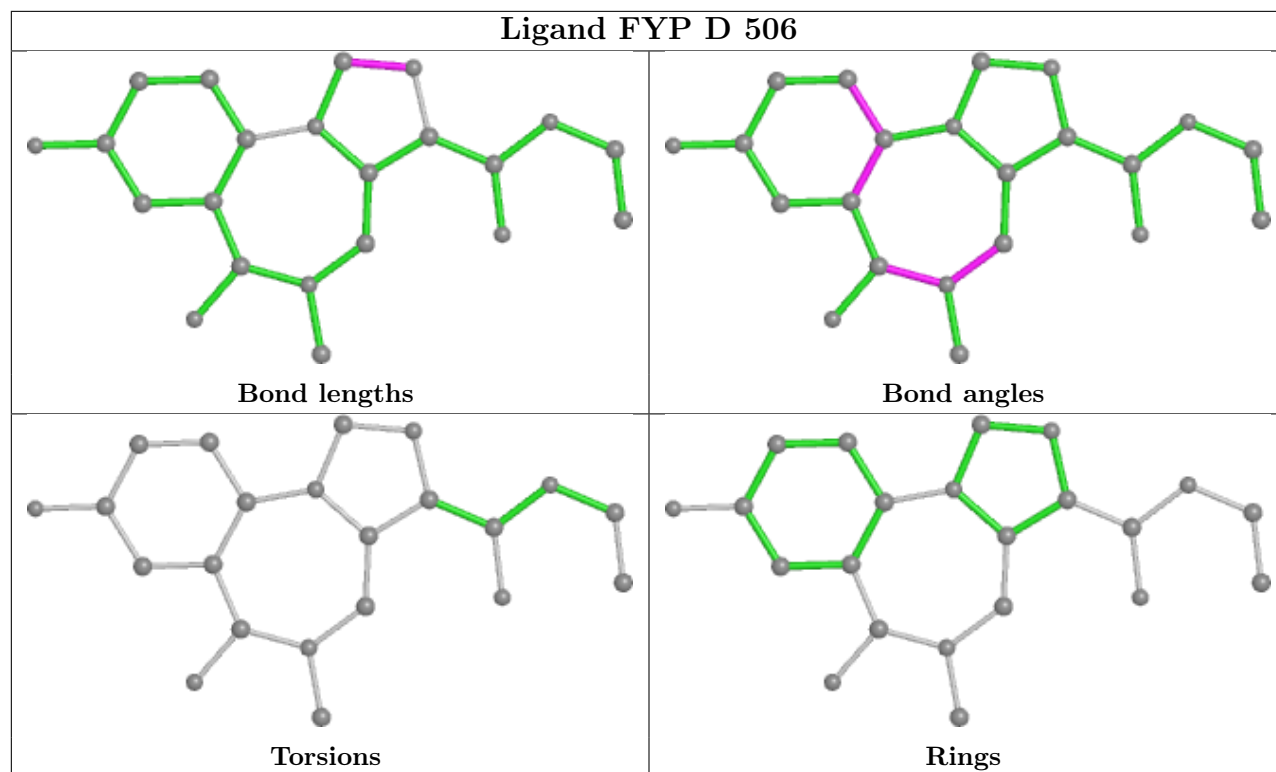

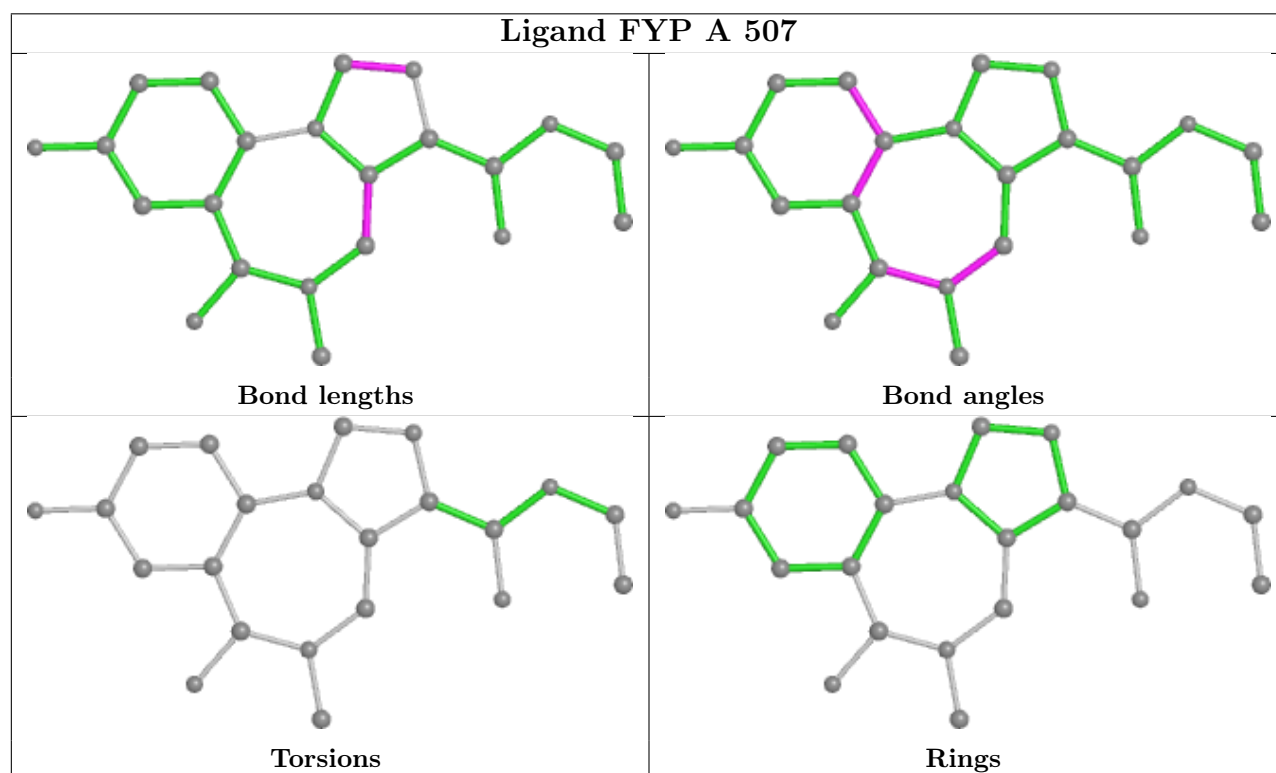
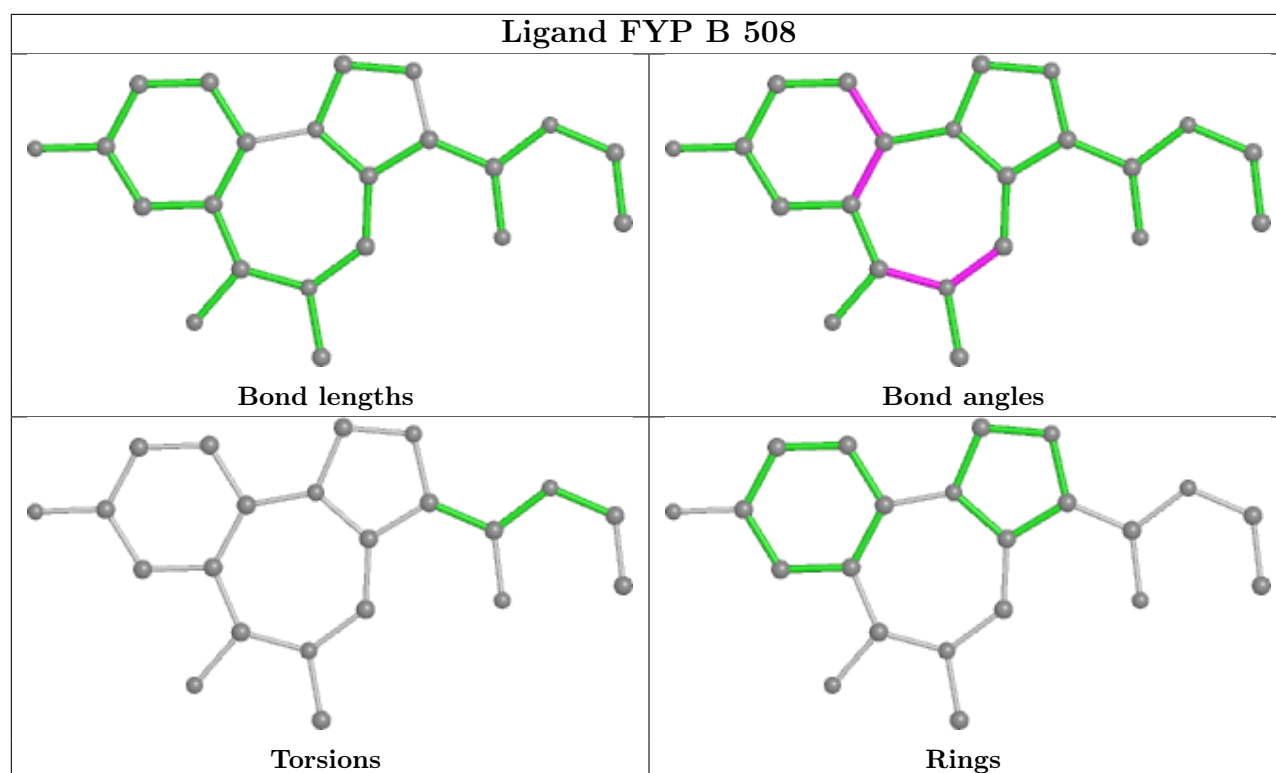

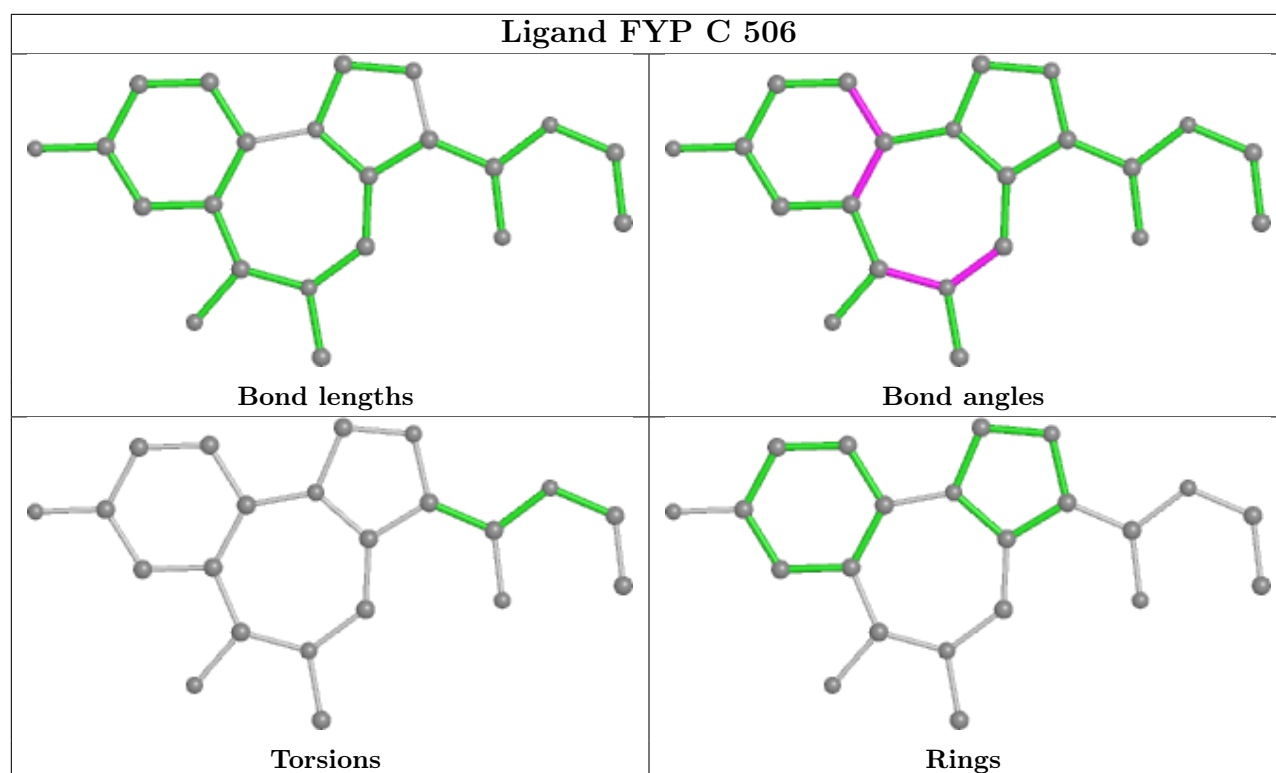

5.7 Other polymers [i](#)

There are no such residues in this entry.

5.8 Polymer linkage issues [i](#)

There are no chain breaks in this entry.

6 Fit of model and data [i](#)

6.1 Protein, DNA and RNA chains [i](#)

In the following table, the column labelled ‘#RSRZ > 2’ contains the number (and percentage) of RSRZ outliers, followed by percent RSRZ outliers for the chain as percentile scores relative to all X-ray entries and entries of similar resolution. The OWAB column contains the minimum, median, 95th percentile and maximum values of the occupancy-weighted average B-factor per residue. The column labelled ‘Q < 0.9’ lists the number of (and percentage) of residues with an average occupancy less than 0.9.

Mol	Chain	Analysed	<RSRZ>	#RSRZ>2	OWAB(Å ²)	Q<0.9
1	A	335/361 (92%)	1.27	75 (22%) 0 0	27, 57, 92, 112	0
1	B	335/361 (92%)	0.88	41 (12%) 4 6	29, 62, 101, 128	0
1	C	335/361 (92%)	1.65	86 (25%) 0 0	31, 76, 128, 149	0
1	D	335/361 (92%)	1.17	63 (18%) 1 1	31, 74, 119, 131	0
1	E	335/361 (92%)	1.23	66 (19%) 1 1	27, 65, 112, 128	0
All	All	1675/1805 (92%)	1.24	331 (19%) 1 1	27, 65, 115, 149	0

The worst 5 of 331 RSRZ outliers are listed below:

Mol	Chain	Res	Type	RSRZ
1	A	15	ILE	13.7
1	B	116	THR	12.0
1	E	84	MET	11.4
1	C	87	LEU	11.4
1	D	84	MET	11.0

6.2 Non-standard residues in protein, DNA, RNA chains [i](#)

There are no non-standard protein/DNA/RNA residues in this entry.

6.3 Carbohydrates [i](#)

There are no monosaccharides in this entry.

6.4 Ligands [i](#)

In the following table, the Atoms column lists the number of modelled atoms in the group and the number defined in the chemical component dictionary. The B-factors column lists the minimum,

median, 95th percentile and maximum values of B factors of atoms in the group. The column labelled 'Q< 0.9' lists the number of atoms with occupancy less than 0.9.

Mol	Type	Chain	Res	Atoms	RSCC	RSR	B-factors(Å ²)	Q<0.9
5	NAG	D	508	14/15	0.67	0.33	102,107,129,129	0
5	NAG	C	508	14/15	0.79	0.21	92,101,121,123	0
2	SO4	C	505	5/5	0.84	0.31	81,83,95,98	0
5	NAG	A	509	14/15	0.84	0.18	74,81,96,97	0
2	SO4	E	507	5/5	0.86	0.29	76,77,83,88	0
2	SO4	D	503	5/5	0.87	0.22	68,70,77,78	0
5	NAG	B	510	14/15	0.87	0.18	74,83,98,103	0
2	SO4	E	502	5/5	0.88	0.20	79,83,88,93	0
3	FYP	E	501	22/22	0.88	0.27	82,86,105,105	0
5	NAG	E	509	14/15	0.88	0.16	93,97,116,116	0
5	NAG	B	511	14/15	0.89	0.17	72,79,94,95	0
2	SO4	D	505	5/5	0.90	0.31	79,82,86,92	0
3	FYP	B	508	22/22	0.90	0.27	61,65,80,80	0
2	SO4	E	506	5/5	0.90	0.28	68,70,78,83	0
2	SO4	A	502	5/5	0.91	0.12	62,70,74,77	0
2	SO4	A	505	5/5	0.91	0.26	92,96,101,102	0
2	SO4	C	501	5/5	0.91	0.25	88,90,96,99	0
2	SO4	C	502	5/5	0.91	0.12	63,65,70,73	0
2	SO4	E	504	5/5	0.91	0.24	66,69,72,76	0
3	FYP	C	506	22/22	0.92	0.28	61,73,87,90	0
2	SO4	B	507	5/5	0.92	0.16	85,86,89,91	0
2	SO4	D	501	5/5	0.93	0.19	85,86,89,91	0
2	SO4	B	501	5/5	0.93	0.12	74,77,81,84	0
2	SO4	B	503	5/5	0.93	0.15	66,67,72,75	0
2	SO4	A	506	5/5	0.93	0.35	67,70,85,88	0
2	SO4	C	503	5/5	0.94	0.17	74,78,83,84	0
2	SO4	A	503	5/5	0.94	0.12	58,59,65,69	0
2	SO4	E	503	5/5	0.94	0.10	64,67,72,76	0
2	SO4	B	504	5/5	0.94	0.13	77,80,81,84	0
2	SO4	B	505	5/5	0.94	0.14	89,90,92,92	0
2	SO4	C	504	5/5	0.95	0.13	88,89,92,93	0
2	SO4	A	504	5/5	0.95	0.14	68,71,75,76	0
2	SO4	B	506	5/5	0.95	0.12	66,68,73,75	0
2	SO4	A	501	5/5	0.95	0.25	70,74,78,83	0
3	FYP	D	506	22/22	0.95	0.23	88,89,111,111	0
2	SO4	E	505	5/5	0.95	0.17	67,68,73,76	0
3	FYP	A	507	22/22	0.96	0.23	58,62,77,77	0
4	P9N	A	508	23/23	0.96	0.22	31,39,44,46	0
4	P9N	D	507	23/23	0.96	0.21	37,47,51,52	0
4	P9N	E	508	23/23	0.96	0.19	39,48,51,55	0
2	SO4	D	502	5/5	0.96	0.18	58,63,68,70	0

Continued on next page...

Continued from previous page...

Mol	Type	Chain	Res	Atoms	RSCC	RSR	B-factors(\AA^2)	Q<0.9
2	SO4	D	504	5/5	0.97	0.11	83,83,88,91	0
2	SO4	B	502	5/5	0.97	0.12	59,60,64,67	0
4	P9N	B	509	23/23	0.97	0.18	33,42,46,47	0
4	P9N	C	507	23/23	0.97	0.21	33,40,46,46	0

The following is a graphical depiction of the model fit to experimental electron density of all instances of the Ligand of Interest. In addition, ligands with molecular weight > 250 and outliers as shown on the geometry validation Tables will also be included. Each fit is shown from different orientation to approximate a three-dimensional view.

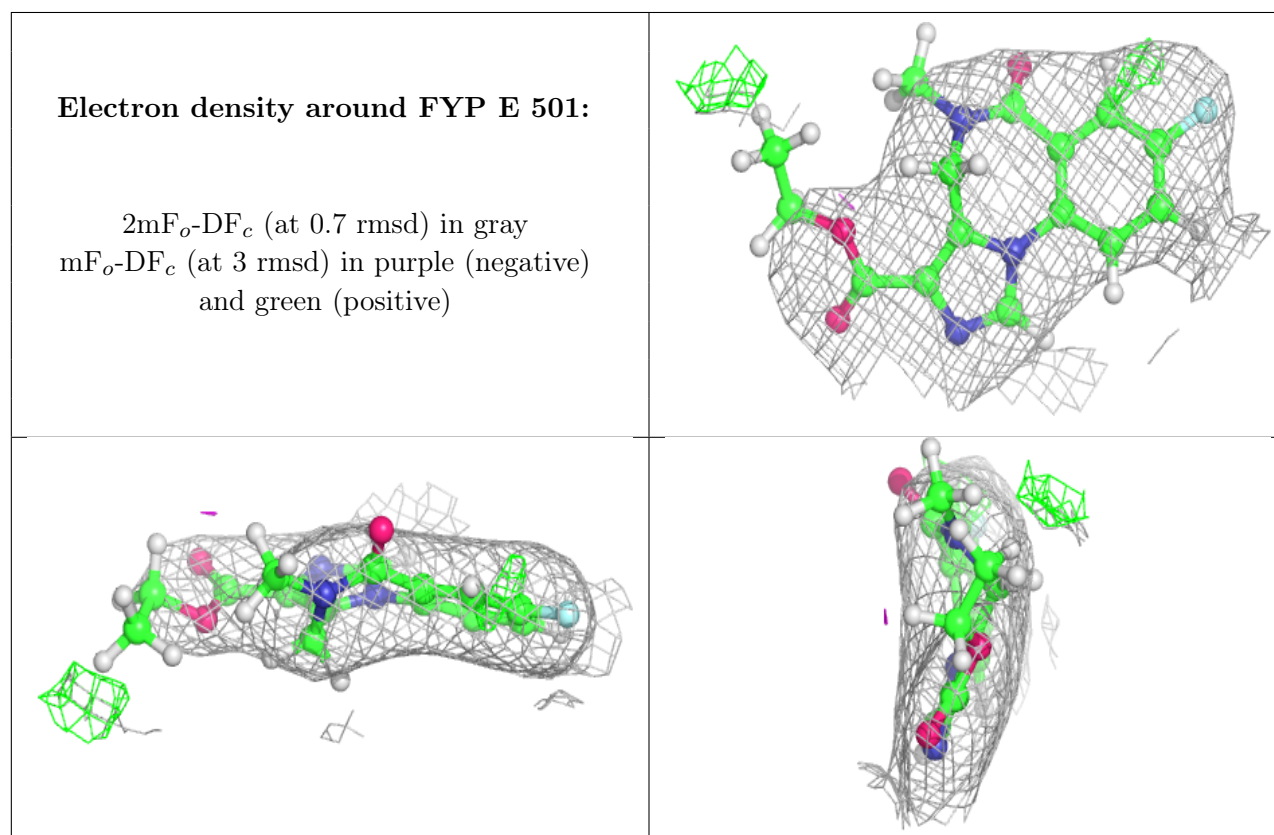

Electron density around FYP B 508:

$2mF_o-DF_c$ (at 0.7 rmsd) in gray
 mF_o-DF_c (at 3 rmsd) in purple (negative)
and green (positive)

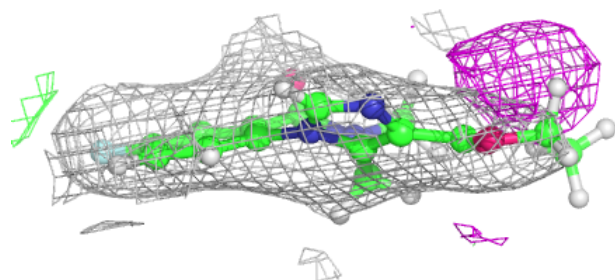
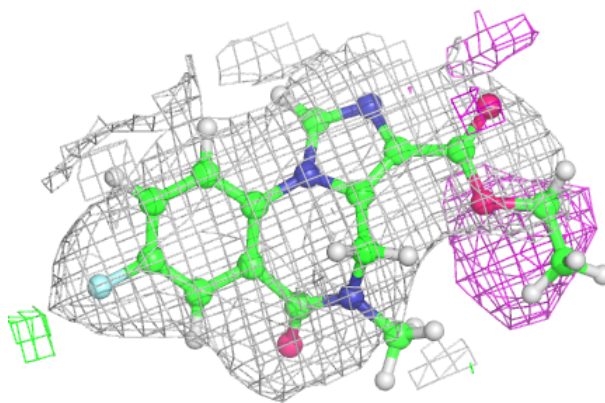
**Electron density around FYP C 506:**

$2mF_o-DF_c$ (at 0.7 rmsd) in gray
 mF_o-DF_c (at 3 rmsd) in purple (negative)
and green (positive)

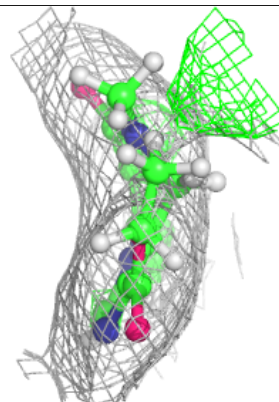
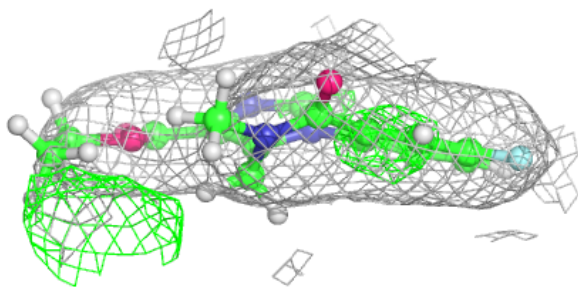
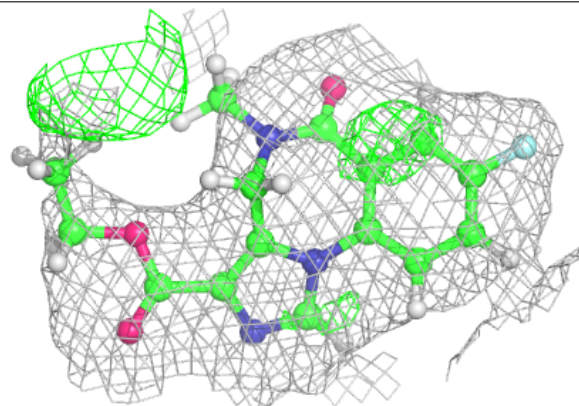

Electron density around FYP D 506:

$2mF_o-DF_c$ (at 0.7 rmsd) in gray
 mF_o-DF_c (at 3 rmsd) in purple (negative)
and green (positive)

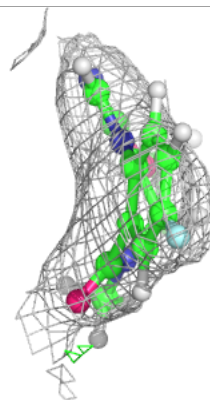
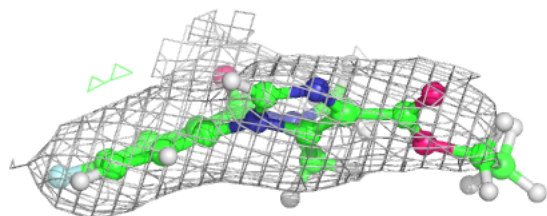
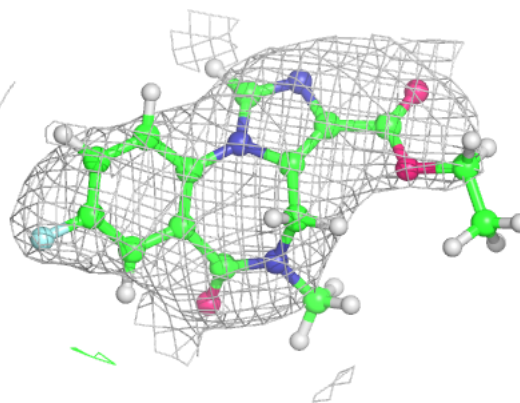
**Electron density around FYP A 507:**

$2mF_o-DF_c$ (at 0.7 rmsd) in gray
 mF_o-DF_c (at 3 rmsd) in purple (negative)
and green (positive)

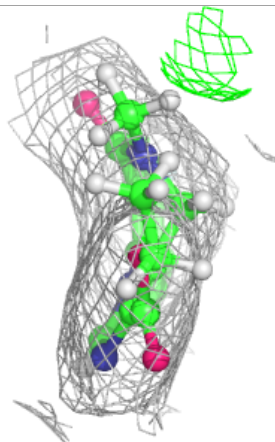
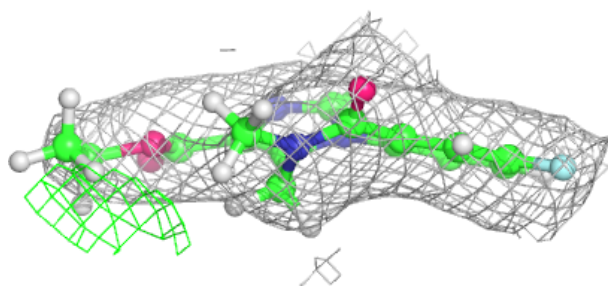
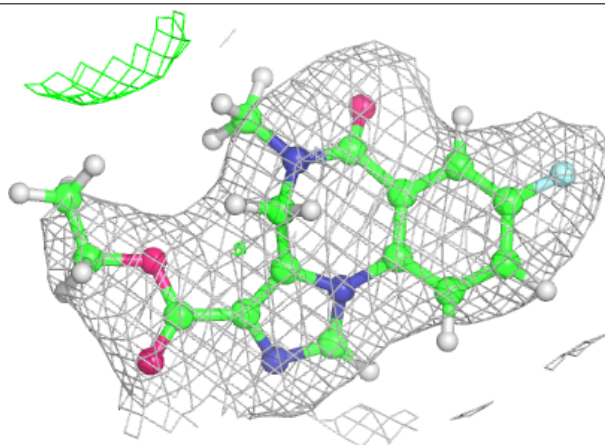

6.5 Other polymers [i](#)

There are no such residues in this entry.