



Full wwPDB X-ray Structure Validation Report ⓘ

May 25, 2020 – 02:24 am BST

PDB ID : 4BFB
Title : BACE2 XAPERONE COMPLEX
Authors : Banner, D.W.; Kuglstatter, A.; Benz, J.; Stihle, M.; Ruf, A.
Deposited on : 2013-03-18
Resolution : 2.21 Å(reported)

This is a Full wwPDB X-ray Structure Validation Report for a publicly released PDB entry.

We welcome your comments at validation@mail.wwpdb.org

A user guide is available at

<https://www.wwpdb.org/validation/2017/XrayValidationReportHelp>

with specific help available everywhere you see the ⓘ symbol.

The following versions of software and data (see [references ⓘ](#)) were used in the production of this report:

MolProbity : 4.02b-467
Mogul : 1.8.5 (274361), CSD as541be (2020)
Xtriage (Phenix) : 1.13
EDS : 2.11
buster-report : 1.1.7 (2018)
Percentile statistics : 20191225.v01 (using entries in the PDB archive December 25th 2019)
Refmac : 5.8.0158
CCP4 : 7.0.044 (Gargrove)
Ideal geometry (proteins) : Engh & Huber (2001)
Ideal geometry (DNA, RNA) : Parkinson et al. (1996)
Validation Pipeline (wwPDB-VP) : 2.11

1 Overall quality at a glance

The following experimental techniques were used to determine the structure:

X-RAY DIFFRACTION

The reported resolution of this entry is 2.21 Å.

Percentile scores (ranging between 0-100) for global validation metrics of the entry are shown in the following graphic. The table shows the number of entries on which the scores are based.

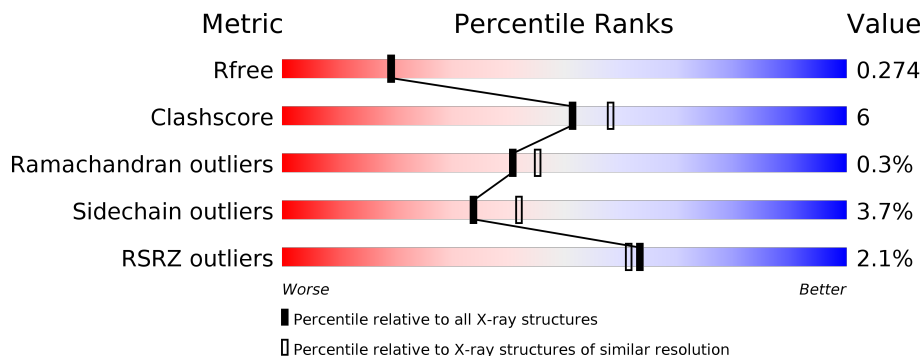

Metric	Whole archive (#Entries)	Similar resolution (#Entries, resolution range(Å))
R_{free}	130704	5912 (2.24-2.20)
Clashscore	141614	6646 (2.24-2.20)
Ramachandran outliers	138981	6543 (2.24-2.20)
Sidechain outliers	138945	6544 (2.24-2.20)
RSRZ outliers	127900	5797 (2.24-2.20)

The table below summarises the geometric issues observed across the polymeric chains and their fit to the electron density. The red, orange, yellow and green segments on the lower bar indicate the fraction of residues that contain outliers for ≥ 3 , 2, 1 and 0 types of geometric quality criteria respectively. A grey segment represents the fraction of residues that are not modelled. The numeric value for each fraction is indicated below the corresponding segment, with a dot representing fractions $\leq 5\%$. The upper red bar (where present) indicates the fraction of residues that have poor fit to the electron density. The numeric value is given above the bar.

Mol	Chain	Length	Quality of chain
1	A	386	 2% 84% 11% . .
1	B	386	 3% 83% 13% .
2	D	122	 72% 18% 10%
2	E	122	 % 87% 12% .

2 Entry composition i

There are 4 unique types of molecules in this entry. The entry contains 7941 atoms, of which 0 are hydrogens and 0 are deuteriums.

In the tables below, the ZeroOcc column contains the number of atoms modelled with zero occupancy, the AltConf column contains the number of residues with at least one atom in alternate conformation and the Trace column contains the number of residues modelled with at most 2 atoms.

- Molecule 1 is a protein called BETA-SECRETASE 2.

Mol	Chain	Residues	Atoms					ZeroOcc	AltConf	Trace
			Total	C	N	O	S			
1	A	373	Total 2917	C 1881	N 464	O 559	S 13	0	4	0
1	B	374	Total 2905	C 1873	N 462	O 557	S 13	0	2	0

- Molecule 2 is a protein called XA4813.

Mol	Chain	Residues	Atoms					ZeroOcc	AltConf	Trace
			Total	C	N	O	S			
2	D	110	Total 827	C 509	N 150	O 164	S 4	0	1	0
2	E	121	Total 918	C 563	N 172	O 179	S 4	0	0	0

- Molecule 3 is 2-[3-(2-HYDROXY-1,1-DIHYDROXYMETHYL-ETHYLAMINO)-PROPYL AMINO]-2-HYDROXYMETHYL-PROPANE-1,3-DIOL (three-letter code: B3P) (formula: $C_{11}H_{26}N_2O_6$).

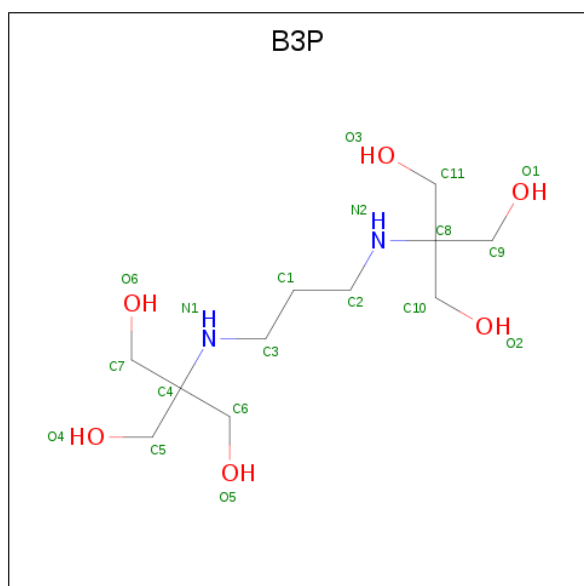

Mol	Chain	Residues	Atoms				ZeroOcc	AltConf
			Total	C	N	O		
3	B	1	19	11	2	6	0	0

- Molecule 4 is water.

Mol	Chain	Residues	Atoms		ZeroOcc	AltConf
4	A	125	Total 125	O 125	0	0
4	B	140	Total 140	O 140	0	0
4	D	49	Total 49	O 49	0	0
4	E	41	Total 41	O 41	0	0

3 Residue-property plots [i](#)

These plots are drawn for all protein, RNA and DNA chains in the entry. The first graphic for a chain summarises the proportions of the various outlier classes displayed in the second graphic. The second graphic shows the sequence view annotated by issues in geometry and electron density. Residues are color-coded according to the number of geometric quality criteria for which they contain at least one outlier: green = 0, yellow = 1, orange = 2 and red = 3 or more. A red dot above a residue indicates a poor fit to the electron density ($RSRZ > 2$). Stretches of 2 or more consecutive residues without any outlier are shown as a green connector. Residues present in the sample, but not in the model, are shown in grey.

- Molecule 1: BETA-SECRETASE 2

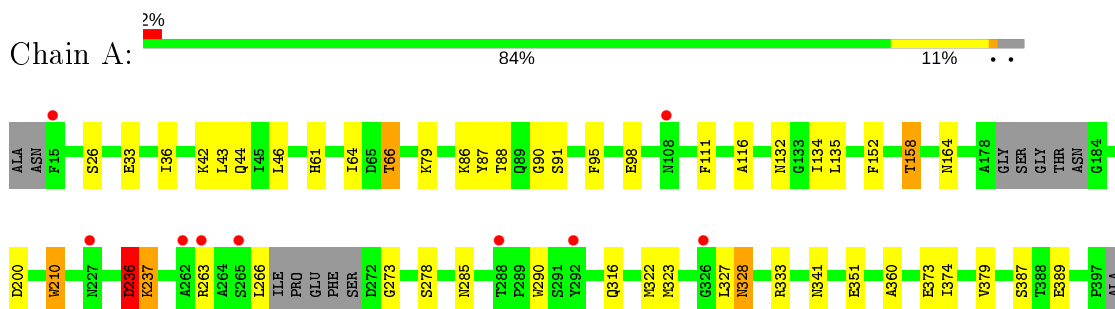

- Molecule 1: BETA-SECRETASE 2

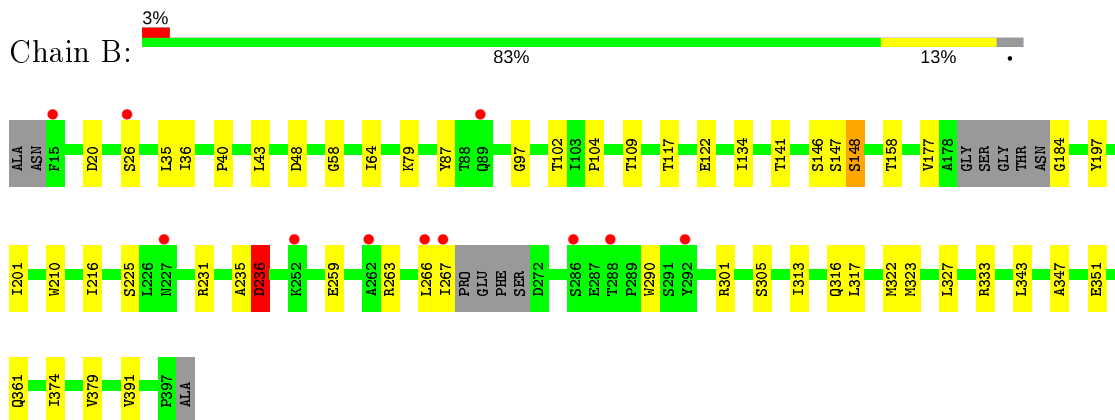

- Molecule 2: XA4813

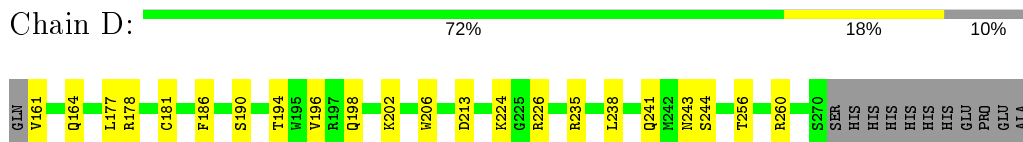

- Molecule 2: XA4813

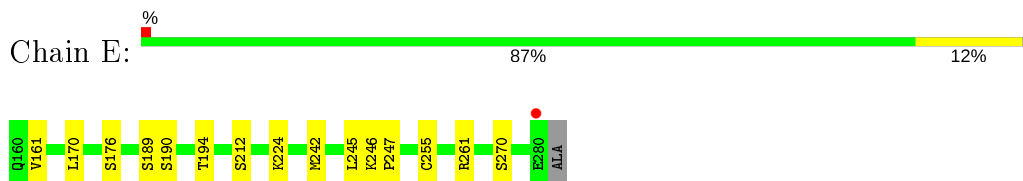

4 Data and refinement statistics

Property	Value	Source
Space group	P 21 21 21	Depositor
Cell constants a, b, c, α , β , γ	62.08Å 71.91Å 214.11Å 90.00° 90.00° 90.00°	Depositor
Resolution (Å)	46.84 – 2.21 46.84 – 2.21	Depositor EDS
% Data completeness (in resolution range)	95.6 (46.84-2.21) 95.6 (46.84-2.21)	Depositor EDS
R_{merge}	0.17	Depositor
R_{sym}	(Not available)	Depositor
$\langle I/\sigma(I) \rangle$ ¹	1.68 (at 2.20Å)	Xtrriage
Refinement program	REFMAC 5.7.0029	Depositor
R, R_{free}	0.204 , 0.273 0.205 , 0.274	Depositor DCC
R_{free} test set	2383 reflections (5.09%)	wwPDB-VP
Wilson B-factor (Å ²)	33.1	Xtrriage
Anisotropy	0.237	Xtrriage
Bulk solvent k_{sol} (e/Å ³), B_{sol} (Å ²)	0.33 , 46.4	EDS
L-test for twinning ²	$\langle L \rangle = 0.48$, $\langle L^2 \rangle = 0.31$	Xtrriage
Estimated twinning fraction	No twinning to report.	Xtrriage
F_o, F_c correlation	0.95	EDS
Total number of atoms	7941	wwPDB-VP
Average B, all atoms (Å ²)	36.0	wwPDB-VP

Xtrriage's analysis on translational NCS is as follows: *The largest off-origin peak in the Patterson function is 9.93% of the height of the origin peak. No significant pseudotranslation is detected.*

¹Intensities estimated from amplitudes.

²Theoretical values of $\langle |L| \rangle$, $\langle L^2 \rangle$ for acentric reflections are 0.5, 0.333 respectively for untwinned datasets, and 0.375, 0.2 for perfectly twinned datasets.

5 Model quality [i](#)

5.1 Standard geometry [i](#)

Bond lengths and bond angles in the following residue types are not validated in this section: B3P

The Z score for a bond length (or angle) is the number of standard deviations the observed value is removed from the expected value. A bond length (or angle) with $|Z| > 5$ is considered an outlier worth inspection. RMSZ is the root-mean-square of all Z scores of the bond lengths (or angles).

Mol	Chain	Bond lengths		Bond angles	
		RMSZ	# Z >5	RMSZ	# Z >5
1	A	0.51	0/2989	0.65	0/4065
1	B	0.52	0/2976	0.69	0/4048
2	D	0.52	0/841	0.71	1/1138 (0.1%)
2	E	0.54	0/939	0.70	0/1272
All	All	0.52	0/7745	0.68	1/10523 (0.0%)

There are no bond length outliers.

All (1) bond angle outliers are listed below:

Mol	Chain	Res	Type	Atoms	Z	Observed(°)	Ideal(°)
2	D	177	LEU	CA-CB-CG	5.32	127.53	115.30

There are no chirality outliers.

There are no planarity outliers.

5.2 Too-close contacts [i](#)

In the following table, the Non-H and H(model) columns list the number of non-hydrogen atoms and hydrogen atoms in the chain respectively. The H(added) column lists the number of hydrogen atoms added and optimized by MolProbity. The Clashes column lists the number of clashes within the asymmetric unit, whereas Symm-Clashes lists symmetry related clashes.

Mol	Chain	Non-H	H(model)	H(added)	Clashes	Symm-Clashes
1	A	2917	0	2832	39	0
1	B	2905	0	2828	31	0
2	D	827	0	808	16	0
2	E	918	0	875	6	0
3	B	19	0	26	1	0
4	A	125	0	0	1	0

Continued on next page...

Continued from previous page...

Mol	Chain	Non-H	H(model)	H(added)	Clashes	Symm-Clashes
4	B	140	0	0	4	0
4	D	49	0	0	1	0
4	E	41	0	0	0	0
All	All	7941	0	7369	84	0

The all-atom clashscore is defined as the number of clashes found per 1000 atoms (including hydrogen atoms). The all-atom clashscore for this structure is 6.

All (84) close contacts within the same asymmetric unit are listed below, sorted by their clash magnitude.

Atom-1	Atom-2	Interatomic distance (Å)	Clash overlap (Å)
1:B:109:THR:HG21	4:B:2059:HOH:O	1.75	0.86
1:A:387:SER:OG	1:A:389:GLU:HG3	1.83	0.78
1:A:42:LYS:HE3	1:A:44[A]:GLN:NE2	2.04	0.73
1:B:58:GLY:HA3	1:B:117:THR:HG22	1.71	0.72
1:A:236:ASP:HB2	1:A:341:ASN:O	1.94	0.68
1:B:177:VAL:HB	1:B:322:MET:HE2	1.75	0.67
1:B:26:SER:HB3	1:B:351:GLU:OE2	1.95	0.66
1:B:64:ILE:HG22	4:B:2032:HOH:O	1.98	0.62
1:B:35:LEU:HB3	1:B:40:PRO:HB3	1.86	0.57
1:B:48:ASP:OD2	1:B:134[B]:ILE:HD11	2.05	0.57
1:A:158:THR:HG21	2:D:256:THR:HG21	1.85	0.57
1:A:33:GLU:HG2	1:A:44[B]:GLN:OE1	2.04	0.57
2:E:189:SER:O	2:E:212:SER:HB2	2.04	0.57
1:B:290:TRP:CD2	1:B:316:GLN:HG3	2.40	0.57
1:B:374:ILE:HD12	1:B:379:VAL:HG11	1.88	0.56
2:D:235:ARG:HD2	4:D:2040:HOH:O	2.04	0.55
1:A:158:THR:HG22	2:D:196:VAL:CG1	2.37	0.55
1:A:374:ILE:HD12	1:A:379:VAL:HG11	1.89	0.54
1:A:285:ASN:ND2	1:A:328:ASN:HA	2.22	0.54
2:D:213:ASP:OD2	2:E:261:ARG:NH2	2.40	0.54
1:A:42:LYS:HE3	1:A:44[A]:GLN:HE21	1.73	0.53
1:A:111[B]:PHE:N	1:A:111[B]:PHE:CD1	2.77	0.53
2:D:181:CYS:HB3	2:D:238:LEU:HB3	1.91	0.53
1:A:158:THR:HG22	2:D:196:VAL:HG11	1.90	0.53
1:B:361:GLN:OE1	2:D:178:ARG:NH2	2.42	0.53
1:A:46:LEU:HB3	1:A:134[A]:ILE:HG22	1.92	0.52
1:A:387:SER:HG	1:A:389:GLU:HG3	1.75	0.52
2:D:241:GLN:NE2	2:D:243:ASN:OD1	2.43	0.52
1:B:216:ILE:HD12	1:B:343:LEU:HD13	1.92	0.51
1:A:290:TRP:CD2	1:A:316:GLN:HG3	2.45	0.51

Continued on next page...

Continued from previous page...

Atom-1	Atom-2	Interatomic distance (Å)	Clash overlap (Å)
1:A:322:MET:CE	1:A:333:ARG:HB2	2.41	0.50
1:A:61:HIS:HB3	1:A:64:ILE:HG12	1.93	0.50
2:D:161:VAL:HB	2:D:260:ARG:HD2	1.93	0.50
1:B:235:ALA:O	1:B:236:ASP:HB2	2.12	0.49
1:A:26:SER:HB3	1:A:351:GLU:OE2	2.12	0.49
1:B:301:ARG:HD3	1:B:305:SER:HB2	1.95	0.49
2:D:161:VAL:HA	2:D:186:PHE:CD1	2.48	0.49
1:B:104:PRO:HD2	4:B:2015:HOH:O	2.12	0.48
1:A:263:ARG:HG3	1:A:263:ARG:O	2.14	0.48
1:A:322:MET:HE3	1:A:333:ARG:CB	2.44	0.47
1:A:66:THR:HG22	1:A:132:ASN:ND2	2.28	0.47
1:B:146:SER:HG	1:B:148:SER:HG	1.62	0.47
1:A:322:MET:CE	1:A:333:ARG:CB	2.93	0.47
1:B:79:LYS:HG3	1:B:97:GLY:HA2	1.97	0.47
1:A:36:ILE:HD12	1:A:43:LEU:HD13	1.97	0.47
2:E:246:LYS:HB2	2:E:247:PRO:HD2	1.97	0.47
1:A:95:PHE:O	1:A:116:ALA:HA	2.15	0.46
1:A:87:TYR:HD2	1:A:90:GLY:O	1.99	0.46
1:B:323:MET:HE1	1:B:327:LEU:CD1	2.45	0.46
1:A:87:TYR:OH	1:A:134[A]:ILE:HD11	2.16	0.46
1:A:322:MET:HE3	1:A:333:ARG:HB2	1.98	0.46
1:B:347:ALA:O	1:B:351:GLU:HG2	2.16	0.45
2:E:170:LEU:HD11	2:E:270:SER:HB3	1.98	0.45
2:E:242:MET:HE2	2:E:245:LEU:HD21	1.98	0.45
1:A:86:LYS:HA	1:A:91:SER:HB3	1.98	0.45
1:B:259:GLU:O	1:B:263:ARG:HB2	2.16	0.45
1:A:135:LEU:HD11	1:A:152:PHE:CG	2.52	0.44
1:A:44[B]:GLN:HA	1:A:44[B]:GLN:OE1	2.17	0.44
1:B:177:VAL:HB	1:B:322:MET:CE	2.45	0.44
1:B:184:GLY:N	4:B:2008:HOH:O	2.50	0.44
1:A:42:LYS:HE3	1:A:44[A]:GLN:HE22	1.82	0.44
1:A:210:TRP:N	1:A:210:TRP:CD1	2.84	0.44
1:A:164:ASN:HB3	1:A:360:ALA:HB2	1.99	0.44
1:B:197:TYR:CZ	1:B:201:ILE:HD11	2.53	0.44
1:B:36:ILE:HD12	1:B:43:LEU:HD13	2.00	0.44
1:B:158:THR:HG22	2:E:194:THR:HG21	2.00	0.43
1:A:44[A]:GLN:CD	1:A:44[A]:GLN:N	2.72	0.43
1:B:313:ILE:HG22	1:B:317:LEU:HD12	2.00	0.43
1:B:323:MET:CE	1:B:327:LEU:HD12	2.49	0.43
1:B:35:LEU:HB2	1:B:102:THR:HB	2.00	0.43
2:D:161:VAL:HA	2:D:186:PHE:HD1	1.84	0.43

Continued on next page...

Continued from previous page...

Atom-1	Atom-2	Interatomic distance (Å)	Clash overlap (Å)
1:A:79:LYS:HE3	2:D:190:SER:O	2.19	0.42
2:D:198:GLN:NE2	2:D:202:LYS:O	2.52	0.42
1:A:158:THR:O	2:D:206:TRP:HB2	2.19	0.42
1:B:322:MET:HE3	1:B:333:ARG:HB3	2.01	0.42
1:A:79:LYS:NZ	1:A:98:GLU:OE2	2.36	0.42
1:B:87:TYR:CE1	3:B:1398:B3P:H112	2.55	0.42
2:D:226:ARG:HB3	2:D:243:ASN:O	2.20	0.41
2:D:194:THR:O	2:D:256:THR:HG22	2.21	0.41
1:A:273:GLY:HA3	1:A:278:SER:OG	2.20	0.41
1:A:210:TRP:CZ2	1:A:237:LYS:HD2	2.55	0.40
1:B:323:MET:HE1	1:B:327:LEU:HD12	2.03	0.40
1:A:327:LEU:HB3	4:A:2116:HOH:O	2.21	0.40
1:B:323:MET:CE	1:B:327:LEU:CD1	2.99	0.40

There are no symmetry-related clashes.

5.3 Torsion angles [i](#)

5.3.1 Protein backbone [i](#)

In the following table, the Percentiles column shows the percent Ramachandran outliers of the chain as a percentile score with respect to all X-ray entries followed by that with respect to entries of similar resolution.

The Analysed column shows the number of residues for which the backbone conformation was analysed, and the total number of residues.

Mol	Chain	Analysed	Favoured	Allowed	Outliers	Percentiles	
1	A	371/386 (96%)	354 (95%)	16 (4%)	1 (0%)	41	45
1	B	370/386 (96%)	355 (96%)	14 (4%)	1 (0%)	41	45
2	D	109/122 (89%)	107 (98%)	2 (2%)	0	100	100
2	E	119/122 (98%)	117 (98%)	1 (1%)	1 (1%)	19	18
All	All	969/1016 (95%)	933 (96%)	33 (3%)	3 (0%)	41	45

All (3) Ramachandran outliers are listed below:

Mol	Chain	Res	Type
1	B	236	ASP
1	A	236	ASP

Continued on next page...

Continued from previous page...

Mol	Chain	Res	Type
2	E	161	VAL

5.3.2 Protein sidechains [i](#)

In the following table, the Percentiles column shows the percent sidechain outliers of the chain as a percentile score with respect to all X-ray entries followed by that with respect to entries of similar resolution.

The Analysed column shows the number of residues for which the sidechain conformation was analysed, and the total number of residues.

Mol	Chain	Analysed	Rotameric	Outliers	Percentiles	
1	A	315/320 (98%)	303 (96%)	12 (4%)	33	41
1	B	314/320 (98%)	302 (96%)	12 (4%)	33	41
2	D	89/99 (90%)	86 (97%)	3 (3%)	37	46
2	E	99/99 (100%)	95 (96%)	4 (4%)	31	38
All	All	817/838 (98%)	786 (96%)	31 (4%)	34	41

All (31) residues with a non-rotameric sidechain are listed below:

Mol	Chain	Res	Type
1	A	66	THR
1	A	88	THR
1	A	158	THR
1	A	200	ASP
1	A	210	TRP
1	A	236	ASP
1	A	237	LYS
1	A	266	LEU
1	A	323	MET
1	A	328	ASN
1	A	373[A]	GLU
1	A	373[B]	GLU
1	B	20	ASP
1	B	122	GLU
1	B	141	THR
1	B	147	SER
1	B	148	SER
1	B	210	TRP
1	B	225	SER
1	B	231	ARG

Continued on next page...

Continued from previous page...

Mol	Chain	Res	Type
1	B	236	ASP
1	B	266	LEU
1	B	267	ILE
1	B	391	VAL
2	D	164	GLN
2	D	224	LYS
2	D	244	SER
2	E	176	SER
2	E	190	SER
2	E	224	LYS
2	E	255	CYS

Some sidechains can be flipped to improve hydrogen bonding and reduce clashes. All (7) such sidechains are listed below:

Mol	Chain	Res	Type
1	A	23	GLN
1	A	279	GLN
1	A	285	ASN
2	D	198	GLN
2	E	164	GLN
2	E	241	GLN
2	E	243	ASN

5.3.3 RNA [i](#)

There are no RNA molecules in this entry.

5.4 Non-standard residues in protein, DNA, RNA chains [i](#)

There are no non-standard protein/DNA/RNA residues in this entry.

5.5 Carbohydrates [i](#)

There are no carbohydrates in this entry.

5.6 Ligand geometry [i](#)

1 ligand is modelled in this entry.

In the following table, the Counts columns list the number of bonds (or angles) for which Mogul statistics could be retrieved, the number of bonds (or angles) that are observed in the model and the number of bonds (or angles) that are defined in the Chemical Component Dictionary. The Link column lists molecule types, if any, to which the group is linked. The Z score for a bond length (or angle) is the number of standard deviations the observed value is removed from the expected value. A bond length (or angle) with $|Z| > 2$ is considered an outlier worth inspection. RMSZ is the root-mean-square of all Z scores of the bond lengths (or angles).

Mol	Type	Chain	Res	Link	Bond lengths			Bond angles		
					Counts	RMSZ	# Z > 2	Counts	RMSZ	# Z > 2
3	B3P	B	1398	-	18,18,18	0.50	0	21,23,23	2.16	2 (9%)

In the following table, the Chirals column lists the number of chiral outliers, the number of chiral centers analysed, the number of these observed in the model and the number defined in the Chemical Component Dictionary. Similar counts are reported in the Torsion and Rings columns. '-' means no outliers of that kind were identified.

Mol	Type	Chain	Res	Link	Chirals	Torsions	Rings
3	B3P	B	1398	-	-	11/28/28/28	-

There are no bond length outliers.

All (2) bond angle outliers are listed below:

Mol	Chain	Res	Type	Atoms	Z	Observed(°)	Ideal(°)
3	B	1398	B3P	C3-N1-C4	7.52	126.74	116.08
3	B	1398	B3P	C2-N2-C8	4.77	122.85	116.08

There are no chirality outliers.

All (11) torsion outliers are listed below:

Mol	Chain	Res	Type	Atoms
3	B	1398	B3P	N1-C4-C5-O4
3	B	1398	B3P	C6-C4-C5-O4
3	B	1398	B3P	C7-C4-C5-O4
3	B	1398	B3P	O3-C11-C8-N2
3	B	1398	B3P	O3-C11-C8-C10
3	B	1398	B3P	C3-C1-C2-N2
3	B	1398	B3P	O3-C11-C8-C9
3	B	1398	B3P	C1-C3-N1-C4
3	B	1398	B3P	C6-C4-C7-O6
3	B	1398	B3P	N1-C4-C7-O6
3	B	1398	B3P	C2-C1-C3-N1

There are no ring outliers.

1 monomer is involved in 1 short contact:

Mol	Chain	Res	Type	Clashes	Symm-Clashes
3	B	1398	B3P	1	0

The following is a two-dimensional graphical depiction of Mogul quality analysis of bond lengths, bond angles, torsion angles, and ring geometry for all instances of the Ligand of Interest. In addition, ligands with molecular weight > 250 and outliers as shown on the validation Tables will also be included. For torsion angles, if less than 5% of the Mogul distribution of torsion angles is within 10 degrees of the torsion angle in question, then that torsion angle is considered an outlier. Any bond that is central to one or more torsion angles identified as an outlier by Mogul will be highlighted in the graph. For rings, the root-mean-square deviation (RMSD) between the ring in question and similar rings identified by Mogul is calculated over all ring torsion angles. If the average RMSD is greater than 60 degrees and the minimal RMSD between the ring in question and any Mogul-identified rings is also greater than 60 degrees, then that ring is considered an outlier. The outliers are highlighted in purple. The color gray indicates Mogul did not find sufficient equivalents in the CSD to analyse the geometry.

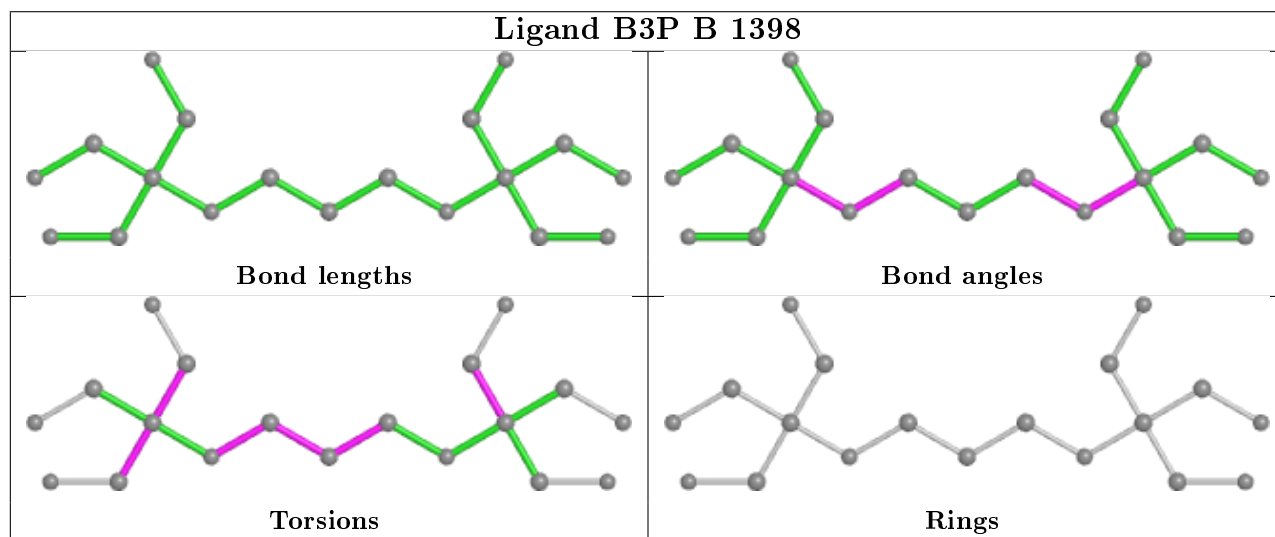

5.7 Other polymers [i](#)

There are no such residues in this entry.

5.8 Polymer linkage issues [i](#)

There are no chain breaks in this entry.

6 Fit of model and data

6.1 Protein, DNA and RNA chains

In the following table, the column labelled ‘#RSRZ> 2’ contains the number (and percentage) of RSRZ outliers, followed by percent RSRZ outliers for the chain as percentile scores relative to all X-ray entries and entries of similar resolution. The OWAB column contains the minimum, median, 95th percentile and maximum values of the occupancy-weighted average B-factor per residue. The column labelled ‘Q< 0.9’ lists the number of (and percentage) of residues with an average occupancy less than 0.9.

Mol	Chain	Analysed	<RSRZ>	#RSRZ>2	OWAB(Å ²)	Q<0.9
1	A	373/386 (96%)	-0.14	9 (2%) 59 57	20, 36, 61, 78	21 (5%)
1	B	374/386 (96%)	-0.16	11 (2%) 51 49	21, 34, 62, 83	15 (4%)
2	D	110/122 (90%)	-0.42	0 100 100	21, 31, 42, 59	3 (2%)
2	E	121/122 (99%)	-0.44	1 (0%) 86 85	21, 30, 46, 50	4 (3%)
All	All	978/1016 (96%)	-0.22	21 (2%) 63 61	20, 34, 59, 83	43 (4%)

All (21) RSRZ outliers are listed below:

Mol	Chain	Res	Type	RSRZ
1	B	15	PHE	6.7
1	A	292	TYR	3.6
1	A	326	GLY	3.4
1	B	266	LEU	3.4
1	A	265	SER	3.0
1	A	108	ASN	2.9
1	A	15	PHE	2.8
1	A	262	ALA	2.8
1	B	89	GLN	2.7
1	A	227	ASN	2.7
1	B	227	ASN	2.6
1	B	252	LYS	2.5
1	B	26	SER	2.4
1	B	262	ALA	2.4
1	B	286	SER	2.4
1	B	288	THR	2.3
1	B	267	ILE	2.2
1	A	263	ARG	2.2
2	E	280	GLU	2.2
1	A	288	THR	2.2
1	B	292	TYR	2.0

6.2 Non-standard residues in protein, DNA, RNA chains [i](#)

There are no non-standard protein/DNA/RNA residues in this entry.

6.3 Carbohydrates [i](#)

There are no carbohydrates in this entry.

6.4 Ligands [i](#)

In the following table, the Atoms column lists the number of modelled atoms in the group and the number defined in the chemical component dictionary. The B-factors column lists the minimum, median, 95th percentile and maximum values of B factors of atoms in the group. The column labelled 'Q< 0.9' lists the number of atoms with occupancy less than 0.9.

Mol	Type	Chain	Res	Atoms	RSCC	RSR	B-factors(Å ²)	Q<0.9
3	B3P	B	1398	19/19	0.76	0.20	53,58,77,77	0

The following is a graphical depiction of the model fit to experimental electron density of all instances of the Ligand of Interest. In addition, ligands with molecular weight > 250 and outliers as shown on the geometry validation Tables will also be included. Each fit is shown from different orientation to approximate a three-dimensional view.

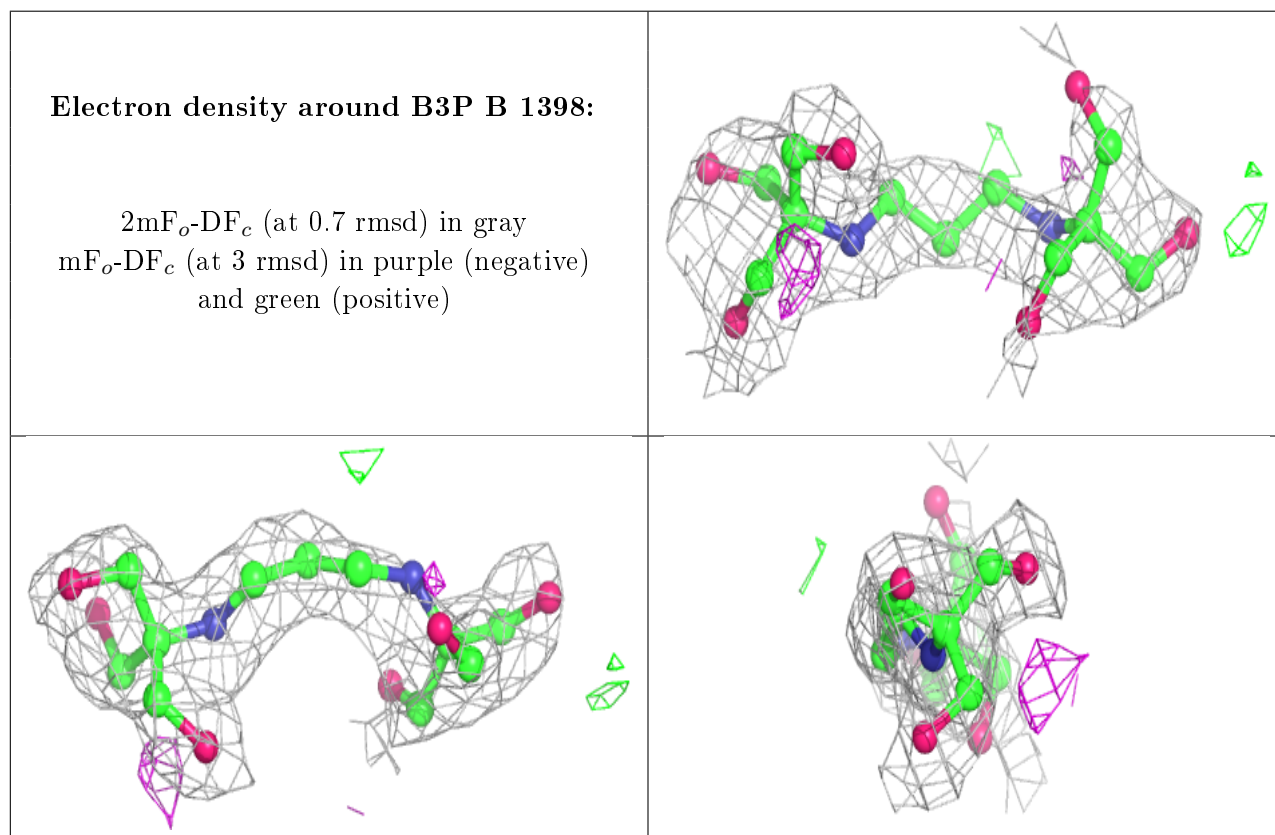

6.5 Other polymers

There are no such residues in this entry.